



*The Art of  
Guitar Making  
by Andrew Allan*





THE  
ART OF  
GUITAR  
MAKING  
BY  
ANDREW  
ALLAN



*The Art of Guitar Making by Andrew Allan*

*ISBN 978-0-9560504-0-3*

*Published in 2008 by The Gilvary Press*

*Copyright © Andrew Allan 2008*

*to order another copy of this book visit:*

*[www.lulu.com/content/1150326](http://www.lulu.com/content/1150326)*

*email: [zavijah123@hotmail.com](mailto:zavijah123@hotmail.com)*



Thanks to:

*My Family - Margaret, Mark, Joanne, David, Julie, Jack xx*  
&  
*Michael Wilson xx*

*Teachers - Paul Hyland & William C. Kelday*  
*Anniesland College Glasgow*  
*[www.anniesland.ac.uk](http://www.anniesland.ac.uk)*





*Contents: 11 - 19*  
*Introduction: 23*  
*Making a Classical: 25 - 183*  
*Steel String Design: 185 - 324*  
*Major Guitar Repairs: 327 - 368*



# *Contents*

<i>Introduction</i> .....	<u>23</u>
<i>Making a Classical</i> .....	<u>25</u>
<i>Solera Workboard</i> .....	<u>26</u>
<i>Finishing off Shooting Board and Cutting out template for Solera</i> .....	<u>27</u>
<i>Making the Solera Workboard</i> .....	<u>28</u>
<i>Checking the Depth of the Scooped Area on the Solera</i> .....	<u>29</u>
<i>Guitar Soundboard</i> .....	<u>30</u>
<i>Plan for Soundboard</i> .....	<u>31</u>
<i>Plywood Template with Sizes</i> .....	<u>32</u>
<i>Checking Template Fits for Guitar Top</i> .....	<u>33</u>
<i>Using Shooting Board to Plane Edges of Front</i> .....	<u>34</u>
<i>Holding Both Pieces up to a Light Source to check for Closeness of Fit</i> .....	<u>35</u>
<i>Thicknessing Guitar Front</i> .....	<u>36</u>
<i>More Thicknessing Guitar Front</i> .....	<u>37</u>
<i>Inlaying Guitar Rosette</i> .....	<u>38</u>
<i>Gluing in Rosette</i> .....	<u>39</u>
<i>Gluing in Rosette</i> .....	<u>40</u>
<i>Cleaning Up Rosette and Top of Soundboard</i> .....	<u>41</u>
<i>Nearing End of Thicknessing of Soundboard</i> .....	<u>42</u>
<i>Cutting Out Guitar Shape and Final thinning around outer edges</i> .....	<u>43</u>
<i>Gluing in the Reinforcing Patch</i> .....	<u>44</u>
<i>Cleaning Reinforcing Patch and Cutting Soundhole</i> .....	<u>45</u>
<i>Soundboard Back and Front</i> .....	<u>46</u>
<i>Planing Soundboard Braces and Gluing them to Soundboard</i> .....	<u>47</u>
<i>Planing and Chiselling down the Soundboard Braces</i> .....	<u>48</u>
<i>Deciding to Round the Braces</i> .....	<u>49</u>
<i>Putting Curve on Harmonic Bar, Gluing and Planing to Size</i> .....	<u>50</u>
<i>Noting Finished Soundboard Thickness</i> .....	<u>51</u>
<i>Noting Finished Brace Sizes</i> .....	<u>52</u>
<i>Guitar Back</i> .....	<u>53</u>
<i>Cleaning Up Rosewood Back and Marking Out</i> .....	<u>54</u>
<i>Checking Template Fits for Guitar Back</i> .....	<u>55</u>
<i>Planing Edge of Guitar Back with Plane using Shooting Board</i> .....	<u>56</u>
<i>Thinning Guitar Back with Cabinet Scraper</i> .....	<u>57</u>
<i>Marking Thickness on Guitar Back for Scraping</i> .....	<u>58</u>
<i>Cutting out Guitar Back and adding Centre Strip</i> .....	<u>59</u>
<i>Preparing Braces and Gluing to Guitar Back</i> .....	<u>60</u>
<i>Finishing Back Braces</i> .....	<u>61</u>
<i>Guitar Sides (Ribs)</i> .....	<u>62</u>
<i>Beginning Planing Guitar Sides</i> .....	<u>63</u>

<i>Planing Guitar Sides</i> .....	64
<i>Thinning Guitar Sides with Cabinet Scraper</i> .....	65
<i>Thinning Guitar Sides with Cabinet Scraper</i> .....	66
<i>Preparing the Guitar Sides for Bending</i> .....	67
<i>Bending the Guitar Ribs</i> .....	68
<i>Second Bending of the Guitar Ribs</i> .....	69
<b>Guitar Neck</b> .....	<b>70</b>
<i>Planing the Brazilian Cedar Neck Blank</i> .....	71
<i>Planing the Cedar Neck Blank</i> .....	72
<i>Cutting the Neck Scarf Joint</i> .....	73
<i>Planing the Neck Scarf Joint</i> .....	74
<i>Checking to make sure Neck Scarf Joint is Square before Gluing</i> .....	75
<i>Adding veneer to Head</i> .....	77
<i>Cleaning up Veneer at Nut and Planing it down</i> .....	78
<i>Shape Plan for Slipper Heel</i> .....	79
<i>Planing down Remainder of Neck Blank to make Guitar Heel</i> .....	80
<i>Planing Sides of Guitar Headstock</i> .....	81
<i>Planing Sides of Guitar Headstock</i> .....	82
<i>Cutting Out Design at top of Headstock</i> .....	83
<i>Drilling the holes for the Machine Head Rollers</i> .....	84
<i>Mistake with one of the holes for machine heads</i> .....	85
<i>Re-drilling plugged machine head roller hole</i> .....	86
<i>Drilling Out the Guitar Headstock Slots</i> .....	87
<i>Drilling Out the Guitar Headstock Slots</i> .....	88
<i>Cleaning out Headstock Slots</i> .....	89
<i>Carving the String Ramps on the Headstock</i> .....	90
<i>Marking Out the Rib Slots on the Guitar Neck</i> .....	91
<i>Marking Out the Rib Slots on the Guitar Neck</i> .....	92
<i>Cutting the Heel Curves and the Rib Slots</i> .....	93
<i>Planing off excess wood on Heel and Tidying Rib Slots</i> .....	94
<i>Making Wedges to hold Ribs in position</i> .....	95
<i>Making Sanding Wedges to clean up Rib Slots</i> .....	96
<i>Chiselling Heel Cap Shape</i> .....	97
<i>Carving Guitar Neck Heel Shape</i> .....	98
<i>Refining Guitar Neck Heel Shape</i> .....	99
<i>Making a Straight Edge for Checking Flatness of Guitar Neck</i> .....	100
<i>Finishing off Carving Neck</i> .....	101
<i>Finishing off Carving Neck</i> .....	102
<i>Finishing off Heel and rest of Neck</i> .....	103
<b>Assembling Guitar Parts</b> .....	<b>104</b>
<i>Making the Heel Block</i> .....	105
<i>Preparing Neck for Gluing to Soundboard</i> .....	106
<i>Attaching End Block and Neck to Soundboard</i> .....	107
<i>Planing and Cutting the Guitar Kerfed Linings</i> .....	108
<i>Preparing Ribs for attaching to Soundboard</i> .....	109

<i>Setting up Go Bar Press for Gluing Ribs</i>	110
<i>Gluing Ribs at Heel and End Block</i>	111
<i>Gluing on Tantalons</i>	112
<i>Block Planing down Ribs for Back Fitting</i>	113
<i>Marking Ribs with chalk and Planing</i>	114
<i>Day Two of Planing Ribs to get Back Fitting</i>	115
<i>Gluing on Linings for Attaching Guitar Back</i>	116
<i>Planing Linings and Chiselling Brace Slots for fitting Back to Body</i>	117
<i>Two Test Runs before Gluing</i>	118
<i>Gluing the Guitar Back with the Spool Clamps</i>	119
<i>Cleaning Up after Gluing</i>	120
<i>Chiselling Binding Channels</i>	121
<i>Inlaying End Block Detail</i>	122
<i>Gluing in End Block Detail and Tidying Up</i>	123
<i>Cutting Purfling Ledge</i>	124
<i>Gluing Purfling Strips to the Guitar</i>	125
<i>Cutting Ledge for Binding Strip</i>	126
<i>Cleaning and Squaring Up Binding Ledge</i>	127
<i>Bending Rosewood Binding Strips</i>	128
<i>Test Run, Scraping Ledge, Gluing Binding then Tying</i>	129
<i>Cleaning Off Animal Glue with Hot Water</i>	130
<i>Cutting Back Purfling Ledge</i>	131
<i>Gluing Back Purfling and Cleaning Up</i>	132
<i>Chiselling Back Binding Ledge</i>	133
<i>Bending and Trimming Back Bindings</i>	134
<i>Gluing Back Bindings and Cleaning Up</i>	135
<i>Heel Cap Maybes 1</i>	136
<i>Heel Cap Maybes 2</i>	137
<i>First Loop Heel Cap</i>	138
<i>First Heel Cap Design</i>	139
<i>New Heel Cap</i>	140
<i>Idea for heel cap through to real heel cap</i>	141
<i>Fingerboard</i>	142
<i>Marking out Fret Slots and Cutting</i>	143
<i>Trimming Fingerboard and Aligning for Gluing To Guitar</i>	144
<i>Mistake with Neck Angle and Gluing on Fingerboard</i>	145
<i>Planing Fingerboard, Re-cutting Fret Slots</i>	146
<i>String Relief</i>	147
<i>Hammering in Frets and Filing Ends</i>	148
<i>Cleaning Up Before Polishing</i>	149
<i>More Cleaning Up Before Polishing</i>	150
<i>Filling up gaps under frets with veneer</i>	151
<i>First Brush Coat of Polish before Grain Filling</i>	152
<i>Grain Filling</i>	153
<i>Re-grain filling ribs &amp; Superglue Filling</i>	154
<i>Second day of Polishing with Rubber</i>	155

<i>Guitars in Workshop Hanging up to Dry</i> .....	156
<i>Third day of Polishing</i> .....	157
<i>Polishing Diary</i> .....	158
<i>Close up of Medullary Ray Lines</i> .....	159
<i>Plan for Making Bridge</i> .....	160
<i>Making Bridge 1</i> .....	161
<i>Making Bridge 2</i> .....	162
<i>Making Bridge 3</i> .....	163
<i>Making Bridge 4</i> .....	164
<i>First attempt at String Tie-Block</i> .....	165
<i>New inlay for Bridge Tie-Block</i> .....	166
<i>Finishing Second Tie-Block</i> .....	167
<i>Third and final Tie-Block!</i> .....	168
<i>Preparing to Glue Bridge</i> .....	169
<i>Gluing on Bridge</i> .....	170
<i>Fret Stoning &amp; Profiling Process</i> .....	171
<i>Widening Holes for Rollers and fitting Machine Heads</i> .....	172
<i>2 views of Ribs while fitting machine heads</i> .....	173
<i>Making Nut</i> .....	174
<i>Nut and Saddle Measurements Together</i> .....	175
<i>Setting up Nut</i> .....	176
<i>Last Few days of Polishing</i> .....	177
<i>Burnishing &amp; Finishing</i> .....	178
<i>Oiling Bridge and Fingerboard / Fine Tuning String Height</i> .....	179
<i>Two Labels</i> .....	180
<i>Finished Guitar Details</i> .....	181
<i>Playing Finished Guitar!</i> .....	182
<b><i>Steel String Design</i>.....</b>	<b>187</b>
<b><i>Initial design ideas</i>.....</b>	<b>188</b>
<i>Design brief / customer requirements</i> .....	189
<i>Final body shape</i> .....	190
<i>Some line drawings from Islamic exhibition in Edinburgh</i> .....	191
<i>Headstock sketches</i> .....	192
<i>Purfling ideas</i> .....	193
<i>Near final ideas for bridge and headstock</i> .....	194
<i>Herringbone and ladder ideas</i> .....	195
<i>Rough sketches for end graft</i> .....	196
<i>Expected instrument specifications before starting plan</i> .....	197
<i>Detail from first draft plan</i> .....	198
<i>Complete plan 1</i> .....	199
<i>Complete plan 2</i> .....	200
<i>Complete plan 3</i> .....	201
<i>Costs of Building Materials &amp; Disposables</i> .....	202
<i>Costs of Building Materials &amp; Disposables</i> .....	203



Sequence of construction.....	204
Record of Timber Names, Densities, Frequencies & Weights.....	205
<b>Steel string cork solera .....</b>	<b>206</b>
Solera using cork.....	207
<b>Rope design for purfling.....</b>	<b>208</b>
Initial attempt to make herringbone purfling.....	209
Cutting into strips for possible rosette or purfling design.....	210
Planing glued strips to an even thickness and cutting into strips.....	211
<b>Soundboard rosette &amp; bracing .....</b>	<b>212</b>
First try at making a rosette.....	213
Second idea for a herringbone inlay with a solid section.....	214
Seeing how this new rosette idea might work.....	215
Re-thinking original rope idea.....	216
First and second attempt at new herringbone idea.....	217
Mistake with cutting channel on either side of the herringbone.....	218
Inlaying two lines around herringbone before thicknessing.....	219
Thicknessing soundboard.....	220
Repairing and studding a major crack in soundboard.....	221
Shaping soundboard X brace then gluing bridge patch.....	222
Gluing down braces and shaping.....	223
Final fitting and gluing of X brace.....	224
Shaping X brace.....	225
Finishing X braced soundboard.....	226
Patch to tidy up rosette under fingerboard.....	227
Completed soundboard thickness / weights & frequencies.....	228
<b>Three piece back and bracing .....</b>	<b>229</b>
Deciding to make a 3 piece back.....	230
Gluing up pieces with rope purfling / herringbone inbetween.....	231
Cleaning up 3 piece back and removing two pieces for headstock.....	232
Thicknessing of back.....	233
Completed back thickness / weights & frequencies.....	234
<b>Guitar neck.....</b>	<b>235</b>
Routing out channel in neck for truss rod.....	236
Marking out the neck angle and preparing to cut the dovetail.....	237
Marking out dovetail on neck and beginning cutting.....	238
Next two saw cuts with rib curve angle.....	239
Dovetail and heel block fitting diagram.....	240
Making the heel block for neck dovetail tenon to fit into.....	241
Cutting out mortice and tidying up.....	242
Bookmatching headstock veneer & inlaying herringbone.....	243
Gluing up headstock veneers.....	244
Plane shavings from headstock herringbone.....	245
Final headstock shape.....	246

<i>Some images of work on headstock &amp; neck</i> .....	247
<b><i>Assembling the Guitar Body</i></b> .....	<b>248</b>
<i>Splitting a side!</i> .....	249
<i>What happened?</i> .....	250
<i>Final one at a time rib clamping solution</i> .....	251
<i>Gluing tatalons, planing ribs &amp; gluing linings</i> .....	252
<i>Bracing cracked rib, bracing back and preparing to glue back on</i> .....	253
<i>Ready to glue back</i> .....	254
<i>Gluing back / cleaning soundboard and sealing with animal glue</i> .....	255
<i>End graft ideas 1</i> .....	256
<i>End graft ideas 2</i> .....	257
<i>End graft ideas 3</i> .....	258
<i>End graft ideas 4</i> .....	259
<i>Design I liked most from sketches</i> .....	260
<i>Final design 1</i> .....	261
<i>Final design drawing</i> .....	262
<i>End graft</i> .....	263
<i>Cutting out shape of graft on ribs and gluing</i> .....	264
<i>Graft complete</i> .....	265
<i>Recutting dovetail, front purfling + binding</i> .....	266
<i>Binding front</i> .....	267
<i>Purfling ideas sketches</i> .....	268
<i>Using heat gun then re-tying bindings to close gaps</i> .....	269
<i>Back purfling and deciding not to use dremel</i> .....	270
<i>Front and Back</i> .....	271
<i>Back binding</i> .....	272
<i>Fitting neck to guitar body</i> .....	273
<i>More fitting neck</i> .....	274
<i>Even more fitting neck then gluing</i> .....	275
<i>Heel cap sketches</i> .....	276
<i>Binding the heel cap</i> .....	277
<i>Re-doing heel binding</i> .....	278
<i>Close up of heel cap binding being glued</i> .....	279
<i>Sketches for fingerboard end design</i> .....	280
<i>Fingerboard preparation</i> .....	281
<i>Fitting truss rod in recess on guitar neck</i> .....	282
<i>Gluing truss rod and cover in place</i> .....	283
<i>Fingerboard clamped on</i> .....	284
<i>Radiusing fingerboard</i> .....	285
<i>Fingerboard sketch ideas</i> .....	286
<i>Inlay work on fingerboard</i> .....	287
<i>Mistake with fretting</i> .....	288
<i>Deciding on volute at back of headstock</i> .....	289
<i>Preparing for Polishing</i> .....	290
<i>Leading up to end of course</i> .....	291

<i>Some french polishing photos day 1</i> .....	<u>292</u>
<i>Some french polishing photos at home days 2, 3, &amp; 4</i> .....	<u>293</u>
<i>More french polishing photos days 5, 6, 7 &amp; 9</i> .....	<u>294</u>
<i>Last weeks</i> .....	<u>295</u>
<b><i>Making steel string bridge</i></b> .....	<u>296</u>
<i>Bridge development</i> .....	<u>297</u>
<i>Bridge sketches</i> .....	<u>298</u>
<i>Preparing to make the bridge</i> .....	<u>299</u>
<i>Routing out saddle slot on bridge</i> .....	<u>300</u>
<i>Saddle positioning and scale length</i> .....	<u>301</u>
<i>Bridge pin hole spacing</i> .....	<u>302</u>
<i>Drilling bridge pin holes and thinning wings</i> .....	<u>303</u>
<i>Bridge abalone inlay idea</i> .....	<u>304</u>
<i>Preparing for gluing bridge to guitar body</i> .....	<u>305</u>
<i>Gluing bridge and fitting bridge pins</i> .....	<u>306</u>
<i>Using wet 2400 grit micromesh to flatten drop filled polish repairs</i> .....	<u>307</u>
<b><i>Guitar setup</i></b> .....	<u>308</u>
<i>Stoning and profiling frets</i> .....	<u>309</u>
<i>Making Nut &amp; Saddle</i> .....	<u>310</u>
<i>Final touches, burnishing, tru &amp; lemon oiling before concert</i> .....	<u>311</u>
<i>Final burnishing before stringing up</i> .....	<u>312</u>
<b><i>Scratchplate ideas</i></b> .....	<u>313</u>
<i>Scratchplate ideas 1</i> .....	<u>314</u>
<i>Scratchplate ideas 2</i> .....	<u>315</u>
<i>Scratchplate ideas 3</i> .....	<u>316</u>
<i>Scratchplate ideas 4</i> .....	<u>317</u>
<b><i>Appraisal of finished guitar</i></b> .....	<u>318</u>
<i>My appraisal: Playability</i> .....	<u>319</u>
<i>My appraisal: Tone/Timbre:</i> .....	<u>320</u>
<i>My appraisal: Next Guitar?</i> .....	<u>321</u>
<i>Me with finished Guitar!</i> .....	<u>322</u>
<b><i>Useful Addresses</i></b> .....	<u>323</u>
<b><i>Major Guitar Repairs</i></b> .....	<u>329</u>
<b><i>Crack repair</i></b> .....	<u>330</u>
<i>Repairing a crack on a guitar soundboard</i> .....	<u>331</u>
<i>Making up studs to brace crack</i> .....	<u>332</u>
<i>Gluing on studs</i> .....	<u>333</u>
<b><i>Splinting a crack</i></b> .....	<u>334</u>
<i>Infilling two wider cracks on the soundboard with similar wood</i> .....	<u>335</u>
<i>Cleaning up and studding two cracks from inside</i> .....	<u>336</u>
<i>Trying to disguise infilled areas on soundboard</i> .....	<u>337</u>

<b>Broken headstock</b> .....	338
<i>Repairing a broken headstock</i> .....	339
<i>Restoring the finish along the breaks</i> .....	340
<i>Second day of restoring the finish</i> .....	341
<i>Third day &amp; fourth day - cleaning off superglue and retouching</i> .....	342
<i>Sanding back polish and painting fingerboard edge</i> .....	343
<b>Fixing a loose back brace</b> .....	344
<i>Assessing job, cleaning up back and braces before gluing</i> .....	345
<i>Tidying up the shape and profile of the brace</i> .....	346
<b>Rib Shatter Patch</b> .....	347
<i>Preparing and gluing on a shatter patch for a broken guitar rib</i> .....	348
<i>Thinning down glued patch and refinishing outside</i> .....	349
<b>Resetting neck joint &amp; full re-fret</b> .....	350
<i>Steaming joint apart</i> .....	351
<i>Explanation of how to get steam into the heel joint</i> .....	352
<i>Discovering it was a dowel joint</i> .....	353
<i>Gluing broken heel to neck &amp; cleaning up body join</i> .....	354
<i>Tilting the neck angle back</i> .....	355
<i>Trying to get the heel fully flush with body</i> .....	356
<i>One mm off heel and effect at same distance along fingerboard</i> .....	357
<i>Final adjustments before regluing neck to body</i> .....	358
<i>Final neck side to side check then gluing</i> .....	359
<i>Removing rest of frets &amp; re-planing fingerboard</i> .....	360
<i>Re-cutting the fret slots</i> .....	361
<i>Re-fretting and fixing gap under fingerboard</i> .....	362
<i>Another way to fix a loose fret</i> .....	363
<i>Re-finishing cracked lacquer around neck join and fingerboard edge</i> .....	364
<i>Final touches to finish</i> .....	365
<i>Stoning and profiling of frets</i> .....	366
<i>Burnishing frets and finishing fretting job</i> .....	367
<i>Shaping and fitting new nut and mistake with saddle height</i> .....	368
<i>Done!</i> .....	369







# Introduction

*I was given my first guitar when I was in my mid teens but I didn't really start playing it properly until I was in my early thirties and that was when I first started to look at how guitars are made. I made my first 3 attempts at playable instruments with only basic woodworking skills (a guitar and 2 mandolins). With those instruments I got accepted to study Stringed Instrument Making at Anniesland College in Glasgow (Scotland). During those 2 years I was given the opportunity to develop a greater understanding of the history, science, and practice of making musical instruments. In my first year there I made a Spanish classical nylon string guitar using high quality tonewoods. In my second year I learned all about major guitar repairs as well as designing and making a second guitar, this time a steel string. These 3 project books (gathered together here in this one volume) were written in the evenings while I was at college to help me with remembering the various processes I was learning each day and also to take note of any mistakes I made along the way. Hope you enjoy reading them.*

AA 15/12/2008





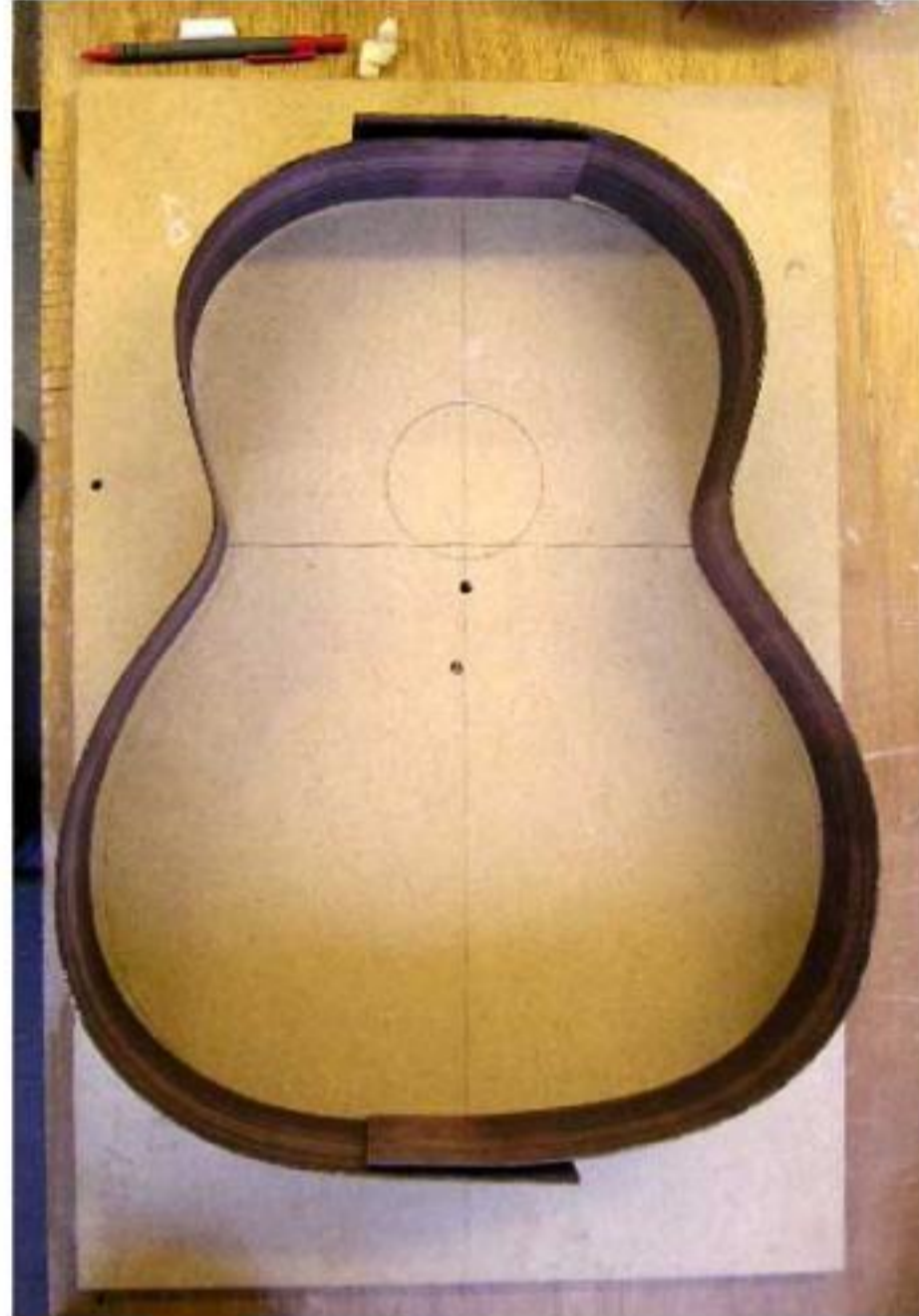

## *Making a Classical*

## *Solera Workboard*

## Finishing off Shooting Board and Cutting out template for Solera

Before beginning the Solera I had to finish off the Shooting Board which I made at the beginning of the course. This involved drilling 8 holes to insert dowels which will be used for shooting any Curved Braces for the inside of the Guitar Soundboard. The wedge which I cut out of the Shooting Board is to allow a clamp to be used for holding down the wood for the braces whilst shooting the edges with the plane.



After completing the shooting board I was then able to plane down a piece of Douglas Fir Spruce to make a long brace with a slight Curve of about 2mm for checking the scooped area on the Solera.

To do this I inserted dowels in the holes on the shooting board at a distance apart slightly smaller than the length of wood to allow the wood to rest against them. Then pushing in the centre of the wood I forced it backwards a slight amount then clamped it down tight. I checked with a straight edge to see how much further back the centre of the wood was compared with the edges and after a few attempts managed to get it right to just about 2mm.

Once in place I was then able to run the 5 and a half plane along the edge of the clamped brace a few times until it was taking a full shaving off. When I released the brace I checked it with the straight edge to check I had made the right depth of curve on the wood.

Next I drew and cut out the rough template for my Solera from mdf allowing enough of a space all around the guitar body shape to insert the 'L' Shaped Clamping Blocks which will hold the sides in place at right angles to the guitar front and back.



## Making the Solera Workboard



The Guitar will lie face down on the Solera so the extended area is for supporting the neck once it is glued onto the soundboard. Because the neck on the Classical Guitar tilts forward slightly, it was necessary here to plane away the extended area at an angle running downhill from the 12 fret body join down to 3mm at the end of the extended area to allow the neck angle to be set correctly while gluing.

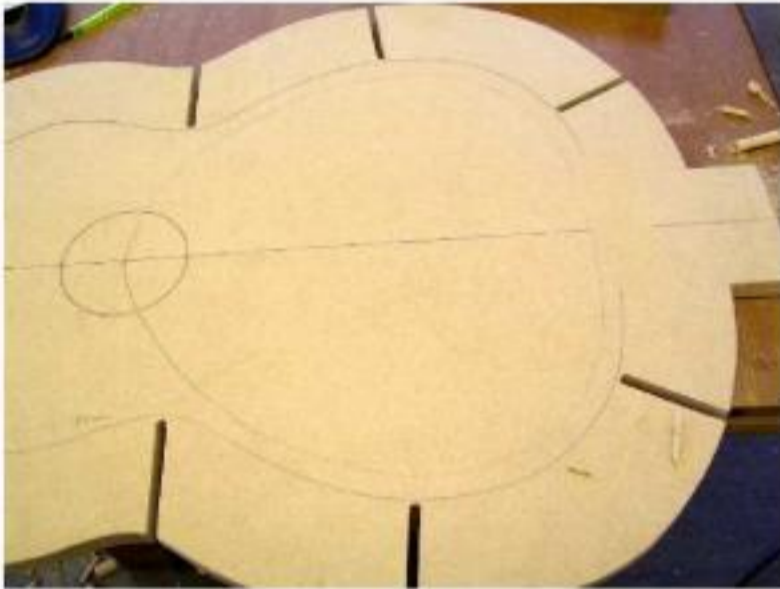

Next I marked out the area of the lower bout which needed to be scooped out slightly so that when the braces are glued in place the soundboard will take on a very slightly arched shape.



Initially I scooped the area using the Compass Plane set at a similar angle to the Curved Brace which I made at the beginning. I worked my way around gradually pivoting out from the area of maximum depth which should be inbetween the soundhole and the bridge. Curving the top in this way I think helps to stop the Soundboard from warping along the width when the tension of the strings pulls the bridge.



After using the Compass Plane I refined the scooped area a bit more with the Cabinet Scraper followed by a small sanding block to try to 'feather' the scooped area towards the upper bout which will remain flat in comparison.

All along I kept checking the depth with the Curved Brace I had made to make sure I didn't carve too deep.

## Checking the Depth of the Scooped Area on the Solera



Finally to check that the scooped area was gradually curving down from the Guitar Outline edge mark on the Solera, to the middle lowest point, I placed a straight edge across the area and checked this all around the entire area. This is important as it will affect the Guitar Top shape once the Harmonic Bars and Braces are glued in position.

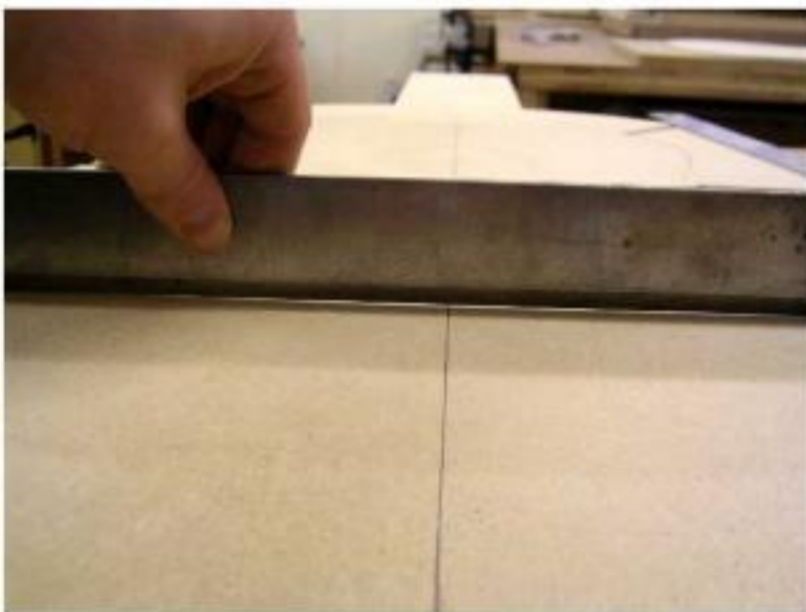

To make the 'L' Shape Clamping Blocks I first had to Cut 8 pieces of Threaded Rod to about 90mm then remove the rough edges with the grinder and a file. This was to clean up the thread to allow the wing nuts to screw on properly.

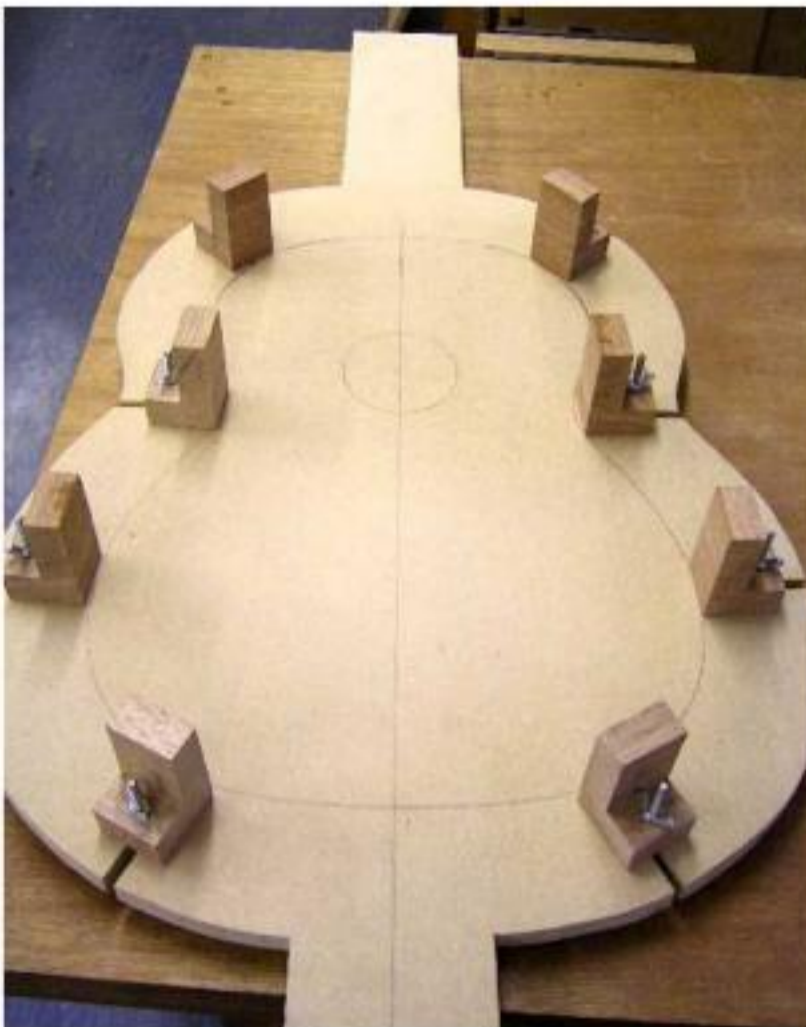

The 'L' Blocks were already cut out so I only had to drill a hole in each just slightly larger than the threaded rod and then tidy up all the blocks a bit by giving them a light sanding.

# *Guitar Soundboard*

## Plan for Soundboard

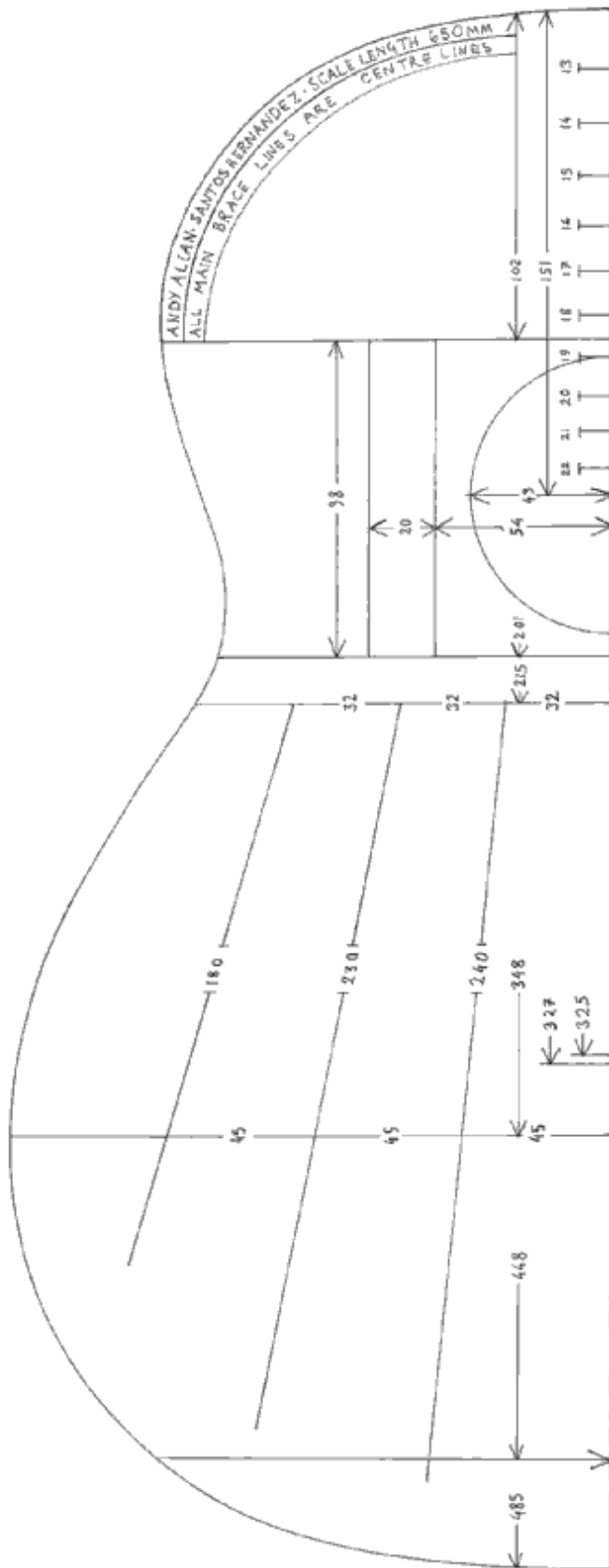

I drew this up based on the Santos Hernandez plan provided by the tutors just to get a bit of practice drawing out a guitar plan and also to allow me to transfer it onto the piece of plywod to make a template (see next page). I also tried to draw on the fret positions after the 12th fret based on the 650mm scale length to allow me to judge where the fret nearest the soundhole would end up. I also drew on the frets beyond the soundhole in case I get the chance to extend it a bit more.



## Plywood Template with Sizes

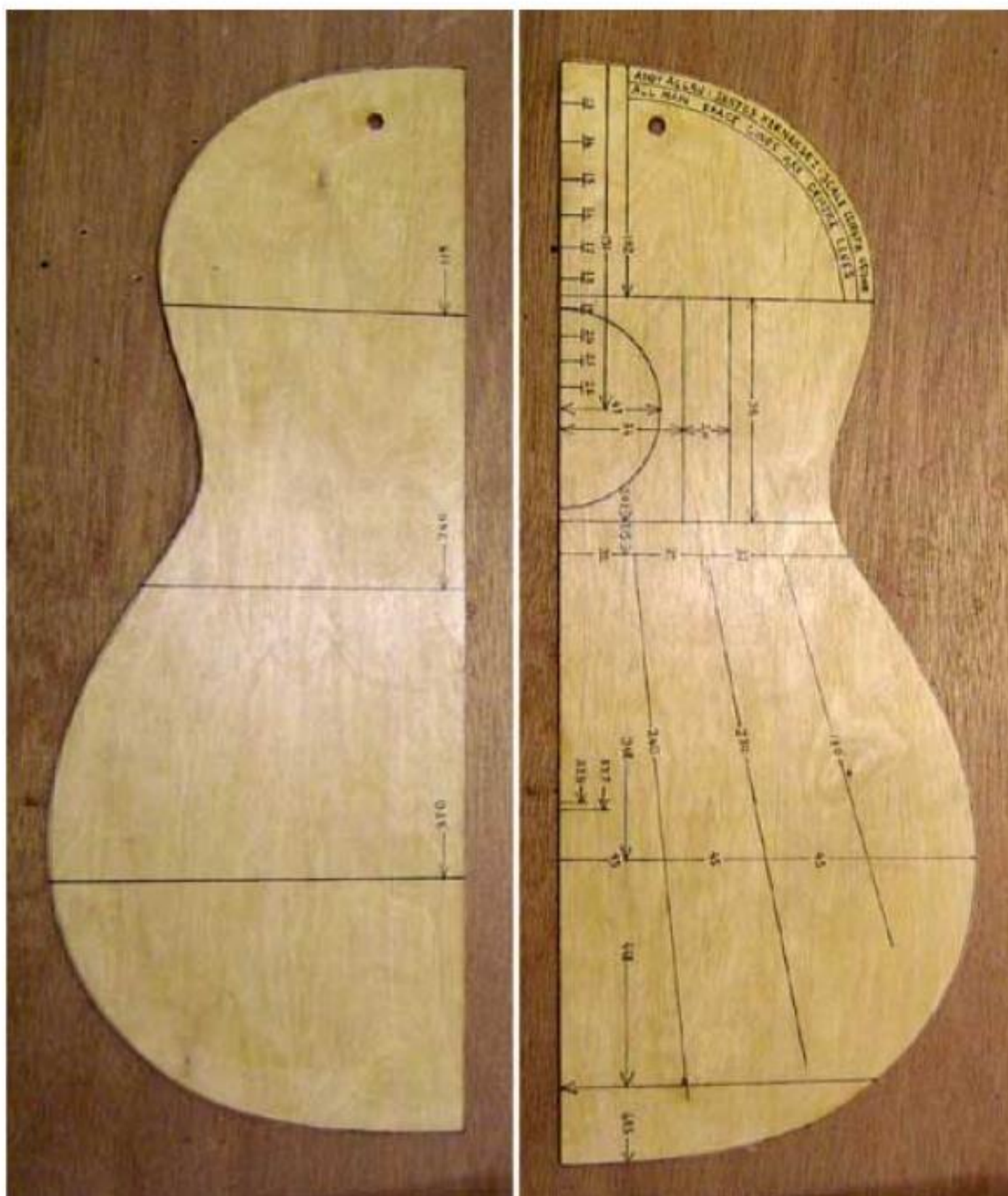

This is the finished template for the soundboard with all the dimensions needed. I drew the template very carefully onto tracing paper and copied it over to the plywood by re-tracing it on the back of this drawing so that the original pencil lines transferred directly onto the wood template. After this I used a black pen to make the lines on the plywood template more permanent. On the back of the template I also marked on the positions of the back braces. Finally I gave the whole thing one coat of varnish all over to keep it in good condition.

## Checking Template Fits for Guitar Top



*Trying template onto bookmatched boards to work out which edge is the best to join them.*

*'Wood Rot' at edge of board (see below).*

*By positioning the smaller uppermost part of the template (the 'upper bout') in the half with the wood rot, the section of the board with the rot can be avoided and this wood discarded.*

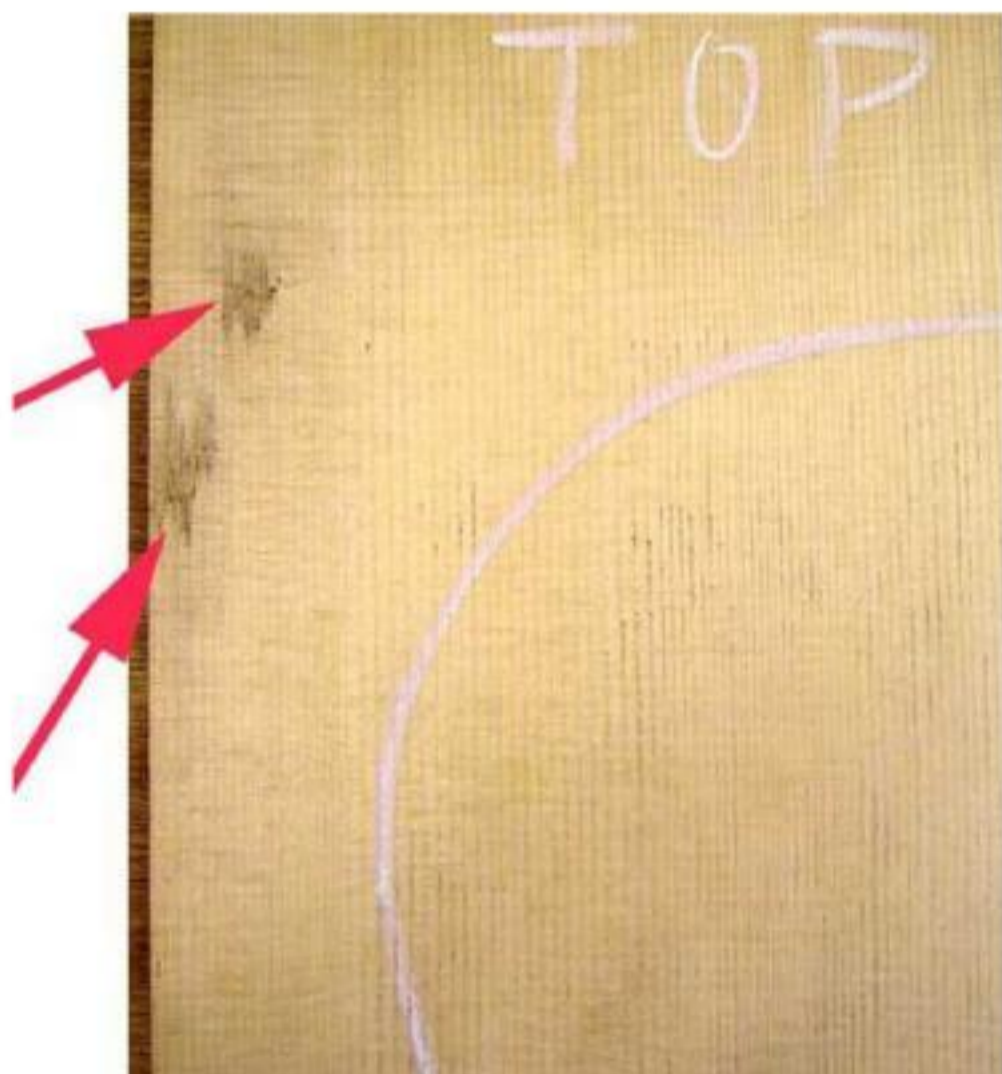

## Using Shooting Board to Plane Edges of Front



Having decided how to join the 2 halves, I then marked out what would be the top of the wood with chalk and also what direction I would be planing in (see drawing at foot of this page).

I then used a number 7 Try Plane on its side on the Shooting Board to square off both edges of the two halves of the Soundboard.

This was quite a difficult process to get exactly right but eventually learned from the course staff that to get it right you need to have a really sharp plane blade and be taking the very finest of shavings off the edges.

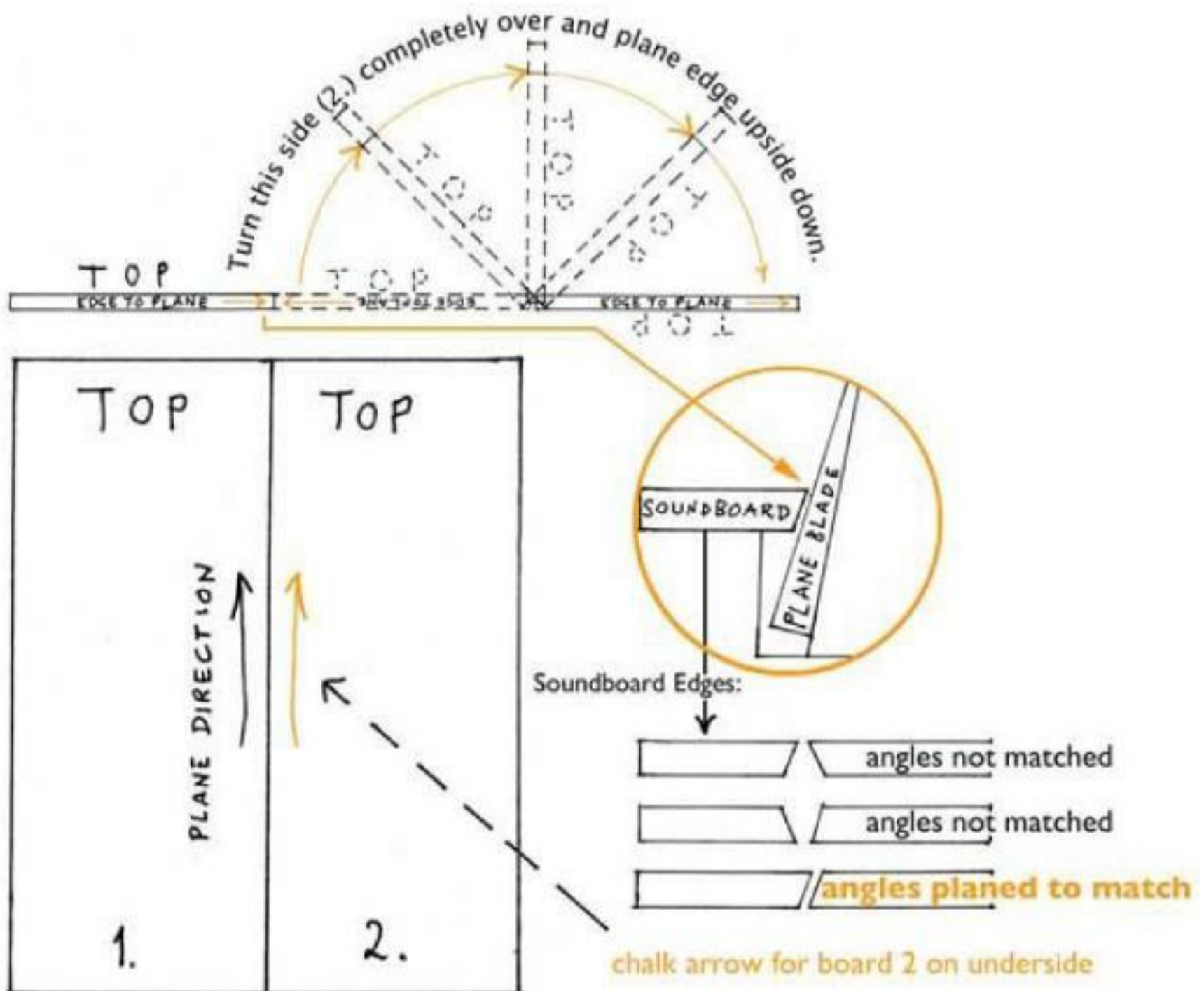

## *Holding Both Pieces up to a Light Source to check for Closeness of Fit*



*Planing edges of soundboard halves with Number 7 Plane on its side on shooting board (left).*



*In the photo on the right I am holding the 2 boards up to a light source and looking to see if I can see any light coming through the gap inbetween the two boards where they have to be joined - called 'Candling'. Took quite a while to do this.*



*Eventually managed to get the two soundboard edges matched up closely enough to make sure hopefully that they will stay together (left).*

*Finally on the right, the guitar front glued with Titebond and held firmly with sash cramps & weights. The board underneath has a slightly narrower width to allow the sash cramps to grip the edges of the soundboard.*



## Thicknessing Guitar Front



I started off by planing the glued joint clean and gradually began to take away most of the remaining saw marks on the spruce.

I then used the thickness caliper to measure the thickness of my guitar top.



As I moved along with the thickness caliper, I marked each measurement with chalk about 2 inches apart until I measured all areas of the wood.

Once the wood was marked out, I then planed back the wood, planing the thickest areas initially and then gradually planing the thinner areas down until I felt that I had approximately evened out the overall thickness.

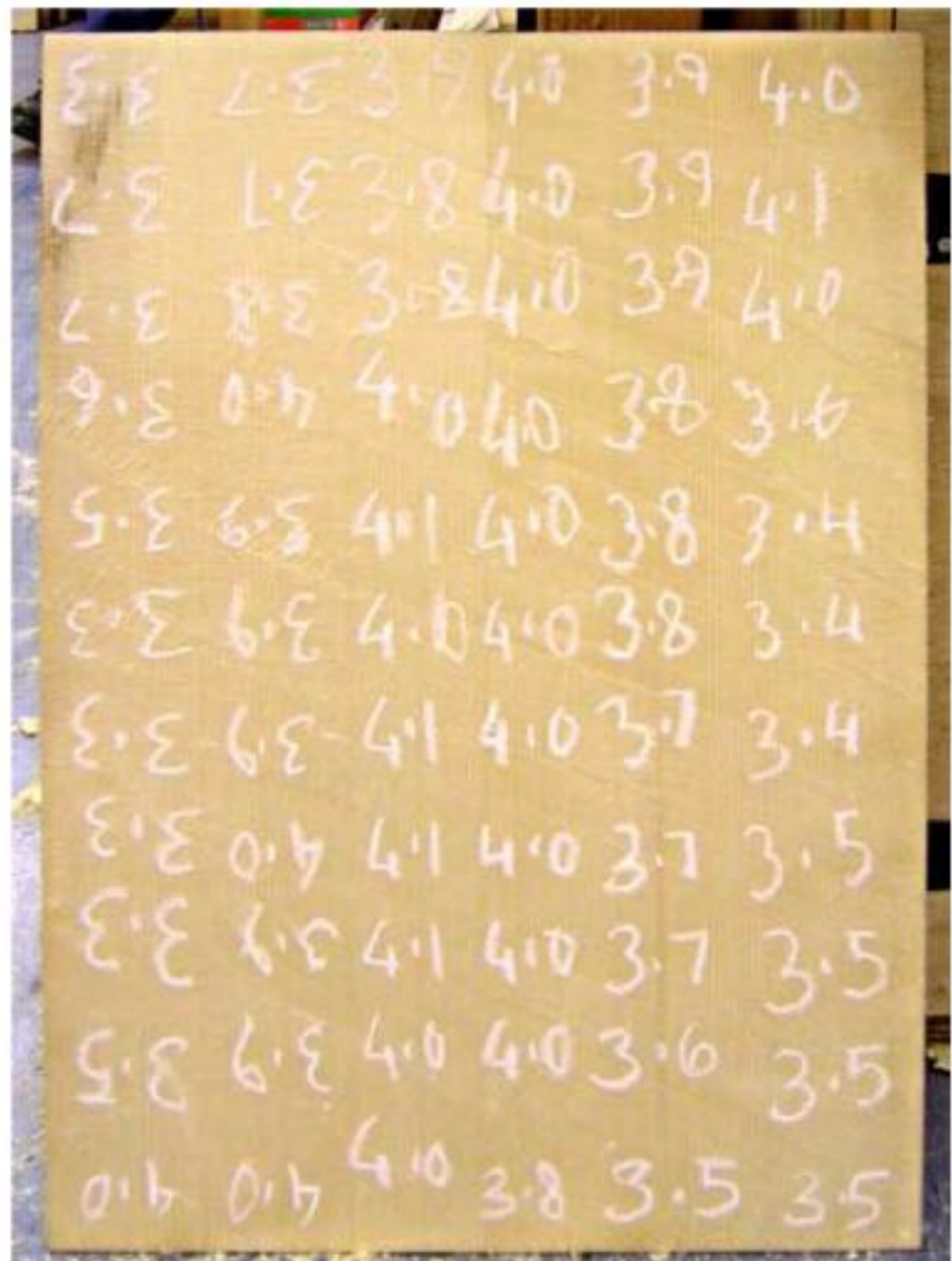

## More Thicknessing Guitar Front

*The wood I was using was quite thick to begin with so I repeated the process of measuring, marking and planing about 3 times before nearing a thickness of about 3.8mm to 3.9mm.*



*Once at this thickness I used the Cabinet Scraper to thin the Soundboard more finely towards a thickness of about 3.5mm which hopefully should leave enough material to inlay a 2mm thick Soundhole Rosette into without cutting right the way through the wood.*



## Inlaying Guitar Rosette

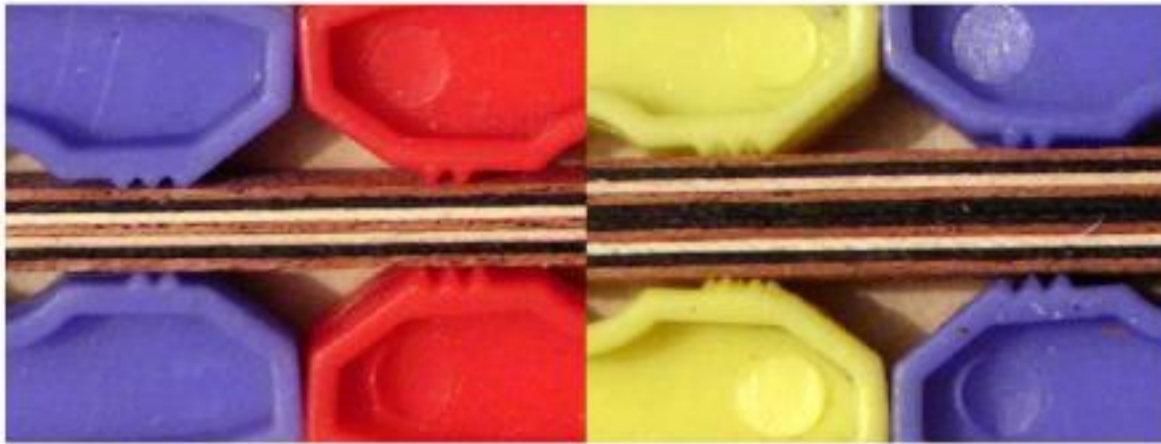

To start with I had the idea of making a rosette with just lines to match the headstock veneers I had chosen.

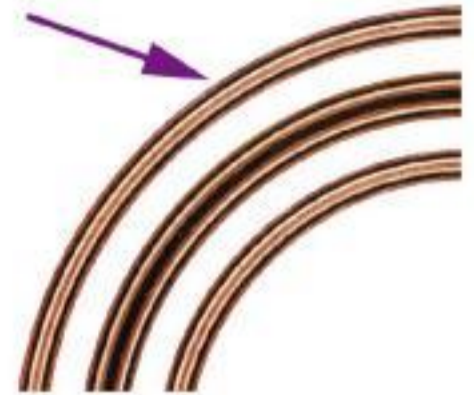

I tried to visualise the idea a bit better on the computer to see how it might look on the guitar (see right). I wasn't totally sure after doing this but continued on with cutting out the first inner line on the soundboard as shown below.

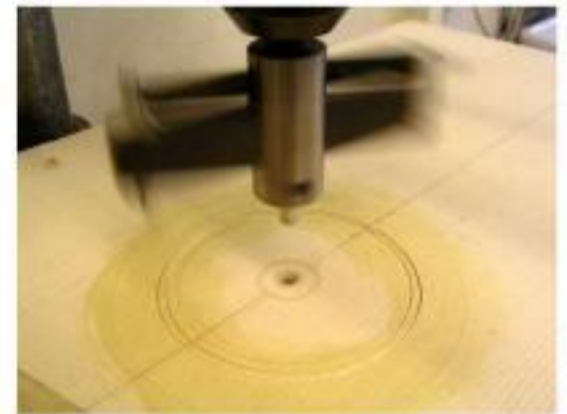
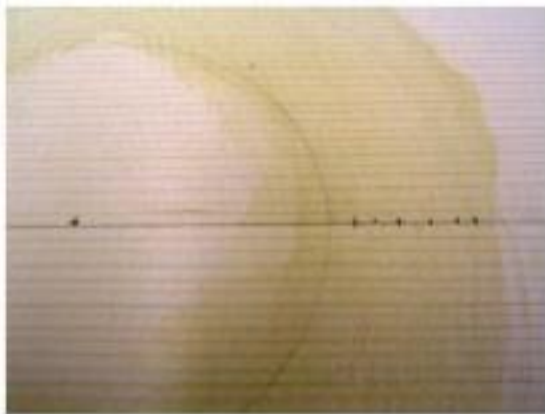

Firstly I painted on a thin quantity of Animal Glue onto the soundboard around where the rosette would be inlaid. This is to prevent the wood from breaking when cutting and Chiselling. Once the glue was left to dry for about an hour I was able to mark out the soundboard where the 3 inlay lines would be and also the width of each. Once I had positioned the soundboard in the right place, I drilled a centre hole and then clamped the whole guitar top to the drill table to stop it from moving. I then set up the circle cutter bit on the pillar drill and adjusted it to the right cutting depth (1.5 - 1.8mm) and also adjusted it for the first cut on the innermost line next to the soundhole.



I then made the first cut successfully. To make the second cut I used the Vernier Calipers, set to the width of the first set of lines to mark onto the wood where the next cut would be. After this cut was made I took the wood off the pillar drill and chiseled out the channel using a very narrow 4mm chisel.

## Gluing in Rosette



After advice from the course staff and also giving it some thought, I understood that this being my first guitar, I'd be better following the tradition of classical guitar making and use the tried and tested mosaic rosette and so completely abandoned the idea of the 3 lines on the previous page.

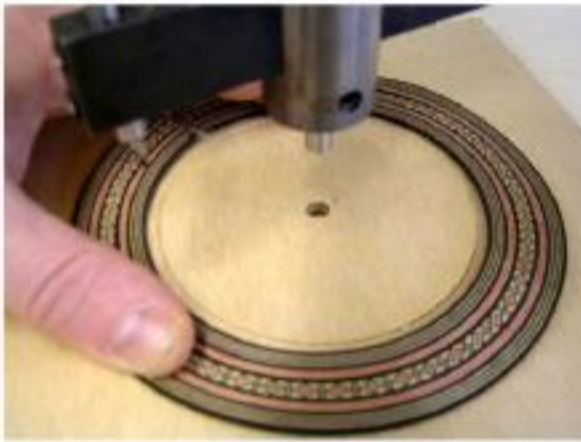

Luckily the classical rosette I was going to use was a bit smaller on the inside line than the line I had cut out initially so I was able to cut in a little closer to the soundhole and bypass this line.

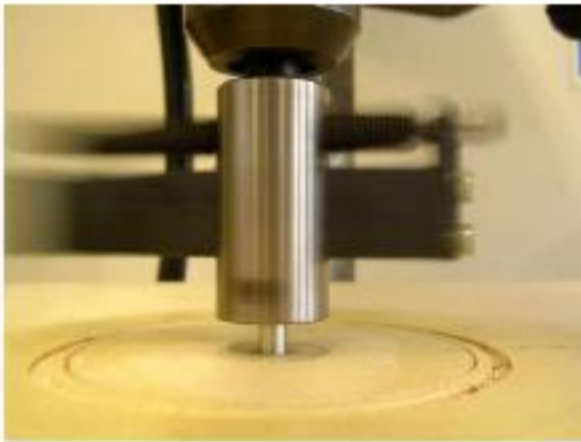

Firstly I checked that the cut that the circle cutter was going to make was correct by turning it on the pillar drill onto a piece of scrap wood. I then compared the rosette with this line to see if it matched. After a couple of tries I managed to get the exact size for the inner line. I made the cut slightly tighter so as to bend the rosette into place in order to correct some of the warping which it seemed to have. I then proceeded to make the cut and after this again compared the rosette in order to mark on where I would make the second cut. All the time I made sure to check the cutter depth so that I did not cut completely through the soundboard.



Once I had made both cuts I then used the 'granny's tooth' router set at a depth of about 1.8mm to 2 mm to level off the complete area the rosette would go into. Once contented with the levelness of this area I then proceeded to the gluing stage.



It was at this point that Paul pointed out that me cutting the channel slightly tighter than the rosette might not have been such a good idea as having to force the rosette around into the channel might mean that there is stress in this area which could eventually lead to the soundboard around the rosette warping possibly. He did say though that perhaps the strengthening on the inside of the guitar at the soundhole might correct this mistake.



## Gluing in Rosette

To prepare for gluing in the rosette I first had to melt some Animal Glue Pellets in a jar with water for about 20 minutes until the glue had completely mixed in with the water. While the glue was melting I had to cut out a circular clamping caul from a piece of scrap wood the same size but slightly narrower than the rosette itself. This was to go on top of the rosette after it was glued in to help press it down fully into the channel made on the soundboard.



Luckily I was able to use the scrap piece of wood I had used to test the size of the cut on the pillar drill which

had already been marked with the correct size of the rosette. I then applied dry soap all around this clamping caul to ensure it didn't stick to the soundboard or the rosette with the glue.

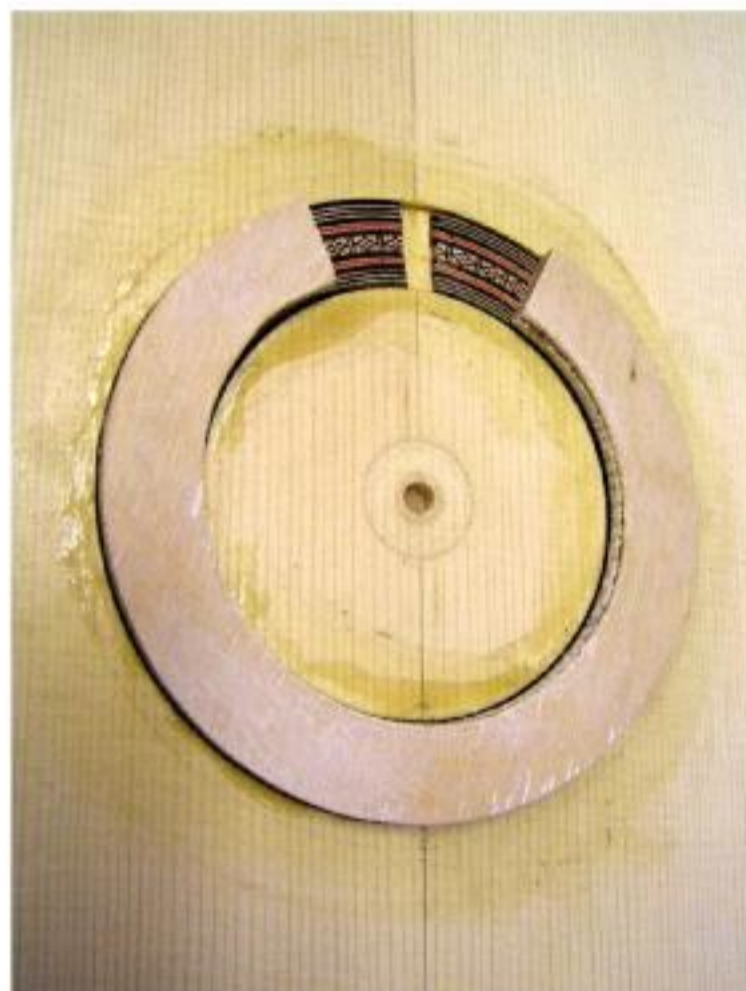

Once the glue was melted, I very quickly painted a good amount

onto the area and slightly over the edges too and pressed the rosette in place. I had to force it into position a little due to me having cut the channel a little tighter than the curve of the rosette.

Once glued I put the clamping caul over it and placed the heavy steel disc and a weight onto the area to keep the rosette in place while gluing.



## *Cleaning Up Rosette and Top of Soundboard*



*Once the rosette was glued in I was able to clean up the front of the top and around the rosette to bring the surfaces level with each other.*



*I worked away with the cabinet scraper initially to bring it the rosette level and then moved onto using a sanding block to give a finer surface*



*At this point I noticed I had made a bit of a scooped out area at the top of the soundboard probably with the cabinet scraper just to the right of where the fingerboard will rest on the top.*

*To try to remedy this I made another sanding block the full width of the soundboard and tried to thin this top area up to the beginning of the rosette being careful not to go over the rosette too many times in case I sanded right through it.*



*This helped a bit but the scooped area is still showing through somewhat and the top is a little thin in that area but hopefully once I have thinned the soundboard out to the final thickness, I will be able to feather it out more around these edges where the scoop is. The top should be thicker in the central area around the bridge and the soundhole but thinner on the outer edges so hopefully once I get to that stage I can sort this out.*



## *Nearing End of Thickening of Soundboard*

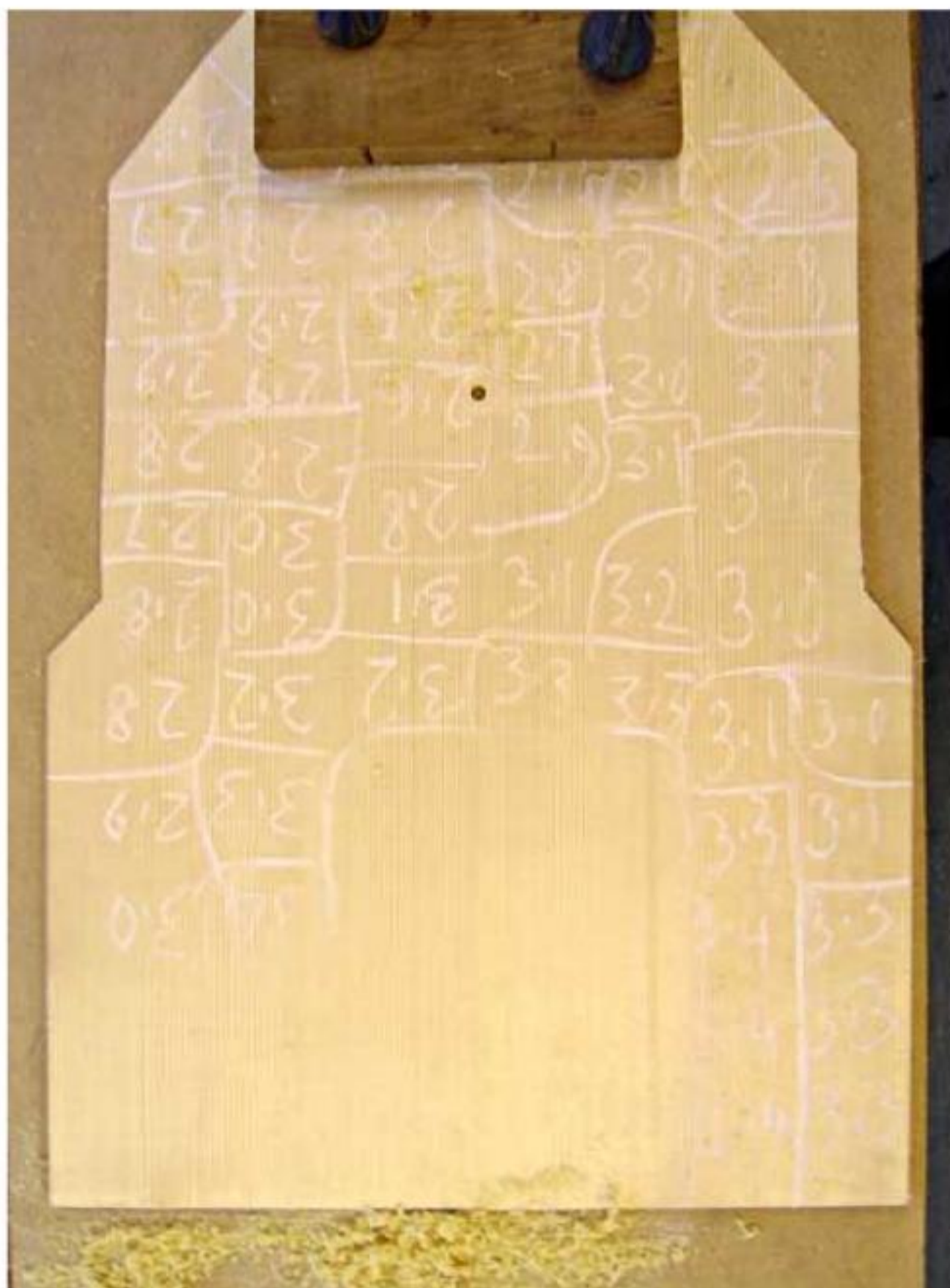

*Having left the front of the soundboard as it is for now, I turned it over and began thinning it from the back at the lower bout end as it was still quite thick in this area. I marked on all my thickness with chalk having used the thickness caliper to gauge the thickness every 2 inches as before.*

*In the end the Soundboard was between 2.0 and 2.7mm. It seemed to be a bit thicker nearer the top upper bout end than at the lower and on average about 2.5 around the edges.*

## Cutting Out Guitar Shape and Final thinning around outer edges

At this stage I drew on with a pencil the guitar shape using the template which I made earlier. First I cut around the shape with a scalpel fairly lightly to break the grain of the wood about 2mm away from the line and then realising that the wood was quite thin, I continued to cut out the top using the scalpel but with a tougher 10A blade.



Once cut out the shape roughly, I sanded the edges using medium to rough sandpaper initially wrapped around an approx 60mm diameter cylinder to get close to the line and then, fine sandpaper to smooth the edges further.

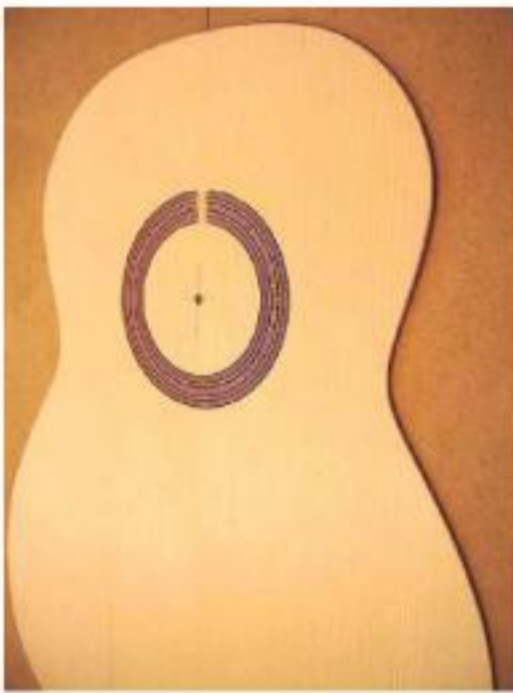

Next I began to draw on in pencil, the lines for the guitar fan braces which will strengthen the now much thinner guitar top.

Because the soundboard is now so thin, the area around the soundhole needs to be strengthened from behind by gluing in a patch of similar wood which will reinforce

it and lessen the chance of the guitar warping under the pressure of the strings.



To cut out the circle I needed another piece of timber as the guitar top I was using was quite small and there was not a lot of extra left over. As before with the rosette, I used the circle cutter on the Pillar Drill to cut out this circular patch from another piece of Spruce. In this photo I am tightening the cutter after adjusting the width of the cut. After this I also checked the depth of the cut as before but to make sure this time that the cutter would cut completely

through and no more. I also made sure to focus on what I was doing and to remember not to put my hand near while the cutter was turning as the pillar drill safety guard can't be used with the circle cutter bit.

## Gluing in the Reinforcing Patch



After cutting out the circle of spruce for the patch, I had to make the two harmonic bars for above and below the sound hole. Using a bench stop, I planed two pieces of Douglas Fir Spruce down to 7mm wide.

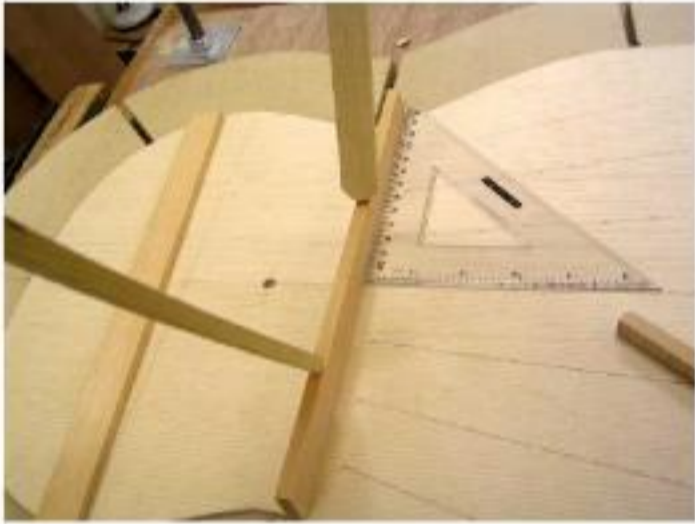

Once these were done I placed the circle for the patch onto the soundboard centering it over the hole in the soundboard using a drill of similar size, making sure the grain of the patch was going the opposite direction to the soundboard.

I then positioned the two harmonic bars on top of the circle drawing in where I needed to cut it for it to fit exactly in place. Once marked up I cut off the excess from the circle and planed the edges neatly with a plane on the shooting board.



The wood I used for the patch was a little rough on the side I was going to glue on so I scraped it with the scraper to bring it down flat and then sanded it very lightly. Once I had the reinforcing patch complete I made a clamping caul from mdf exactly the same size and shape as it.

After this I prepared some go bars at the go bar press and clamped in place one of the harmonic bars. To make sure this was in the correct position I used a set square flush against the harmonic bar to make sure it was square with the line down the middle of the soundboard.

I then applied titebond to the patch, avoiding going too near the centre to keep the pilot holes clean. Once glue was applied I lined up the clamping caul hole with the hole in the centre of the patch and placed them both onto the soundboard lining them up with the same hole on the soundboard. I then used the other end of a drill bit to hold all three in position and checked the patch was flush all along with the harmonic bar. After this I added several go bars to hold the caul firmly in place while gluing and finally removed the harmonic bar again and cleaned the glue away from around the patch.

Scraping and sanding the patch before applying means that there was a bit of a gap on some edges of it once glued probably because I had rounded them a little by accident. If I was to do this again, I would clean up the whole piece of spruce before cutting the patch out and that that should help avoid any round edges on the gluing surface.

## Cleaning Reinforcing Patch and Cutting Soundhole

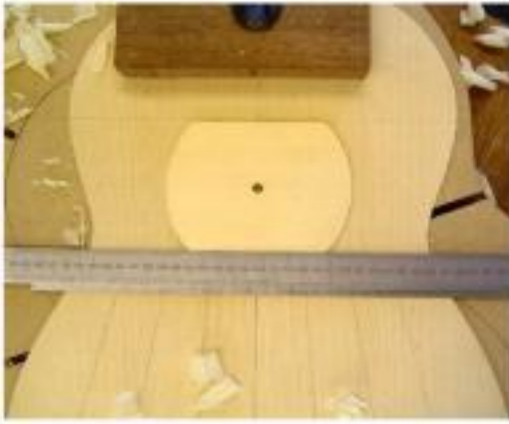

Once the patch was glued in place and dry I planed it flat with the block plane to just about 2mm thick or two thin steel rules placed alongside the patch as a guide to check the depth.



After this was done I set up the Pillar Drill with the circle cutter bit initially drilling a hole in MDF with a similar sized bit to the guiding centre piece of the circle cutter - Once this pilot hole was drilled in the mdf, I clamped the board down to the pillar drill table to ensure it didn't move and then attempted to align the centre of the soundboard over this guiding hole. To check it was centred correctly and that the cutter would cut the hole out the same distance all around away the rosette, I locked the circle cutter in place in the pilot hole using the pillar drill height locking lever and tried to look around the centre hole in the soundboard to see that the slight gap around the bit centre was the same all round. After this with the soundboard now clamped to the drill table, I tried to check all around by turning the cutter bit by hand in the chuck to see where the blade was going to hit the wood. After some adjustments, I went ahead and turned on the drill to cut out the soundhole. I was told to do it half way and then half way from the other side but decided because I was having trouble with aligning the centre hole to just go all the way through on the first cut. Also I made sure to focus on not putting my hand near the cutter bit while it was turning.



The cut was successful though it was slightly off centre in the end due I think to the centre hole in the soundboard being a bit widened over time. I corrected it as best as I could with sandpaper doublesided onto a large solid cylinder shape and this helped gradually bring the hole into alignment with the rosette.



After this I rounded off all the edges of the patch except the two sides that will be against the harmonic bars on the inside using initially the chisel followed by fine sandpaper.



## *Soundboard Back and Front*

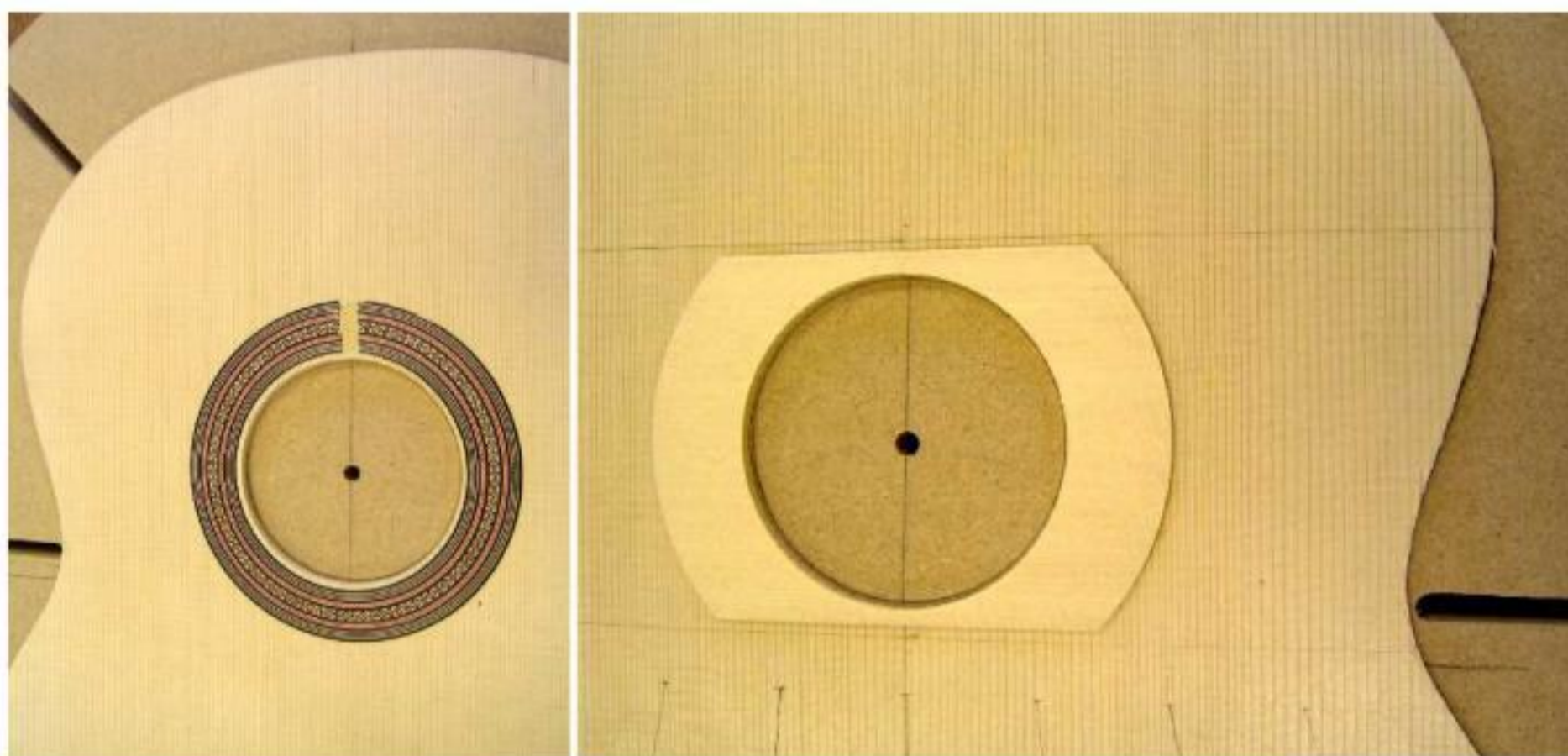

*The outside and the inside view of the soundboard after cutting out the soundhole. The next stage will be making up the fan braces and gluing them in position.*

## Planing Soundboard Braces and Gluing them to Soundboard



To make the fan braces I had to cut 7 lengths of wood initially to about 8 x 8mm. On the plan the braces were to be 7 x 3.5mm but these were thought to be too wide for the type of wood I was to use which was quite stiff Douglas Fir Spruce. The dimensions then were changed to just 5 x 3mm.

With the new dimensions, I carefully block planed each fan brace making sure to check each rod of wood for flatness with the straight edge and also to judge by eye for any skewing.

Once the braces were cut and planed I made up 3 clamping cauls the same size as the braces to protect them when clamping them in the Go Bar Press and also to spread the force out a bit. I started with the middle 3 braces making sure to leave the wood grain pointing up the way from

the soundboard surface and worked my way out the way. I left them to dry for at least an hour though ideally it would be better to leave them all overnight to make sure.



Drawing of how each fan brace will be shaped after they are glued in place.

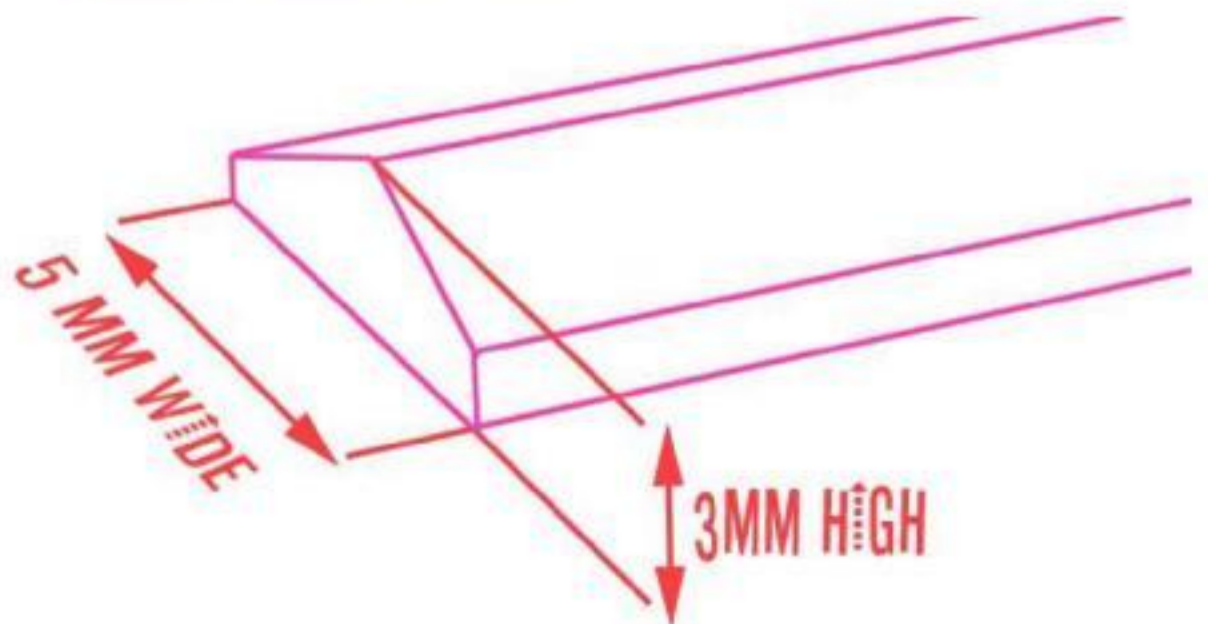



## *Planing and Chiselling down the Soundboard Braces*



*Now that the braces were glued on it was time to plane them down to 5 x 5mm which I did using the Block Plane. I checked the height using the other end of the Vernier Caliper.*

*Once they were 5mm high, I used the chisel at an angle to try to achieve the 'Gable' style angle on each brace. I managed to do this fairly successfully though I did notice my chisel could have probably been sharper.*

*At this point I also noticed I had glued the first brace on the left with the grain not facing up the way. The other six were all ok though.*

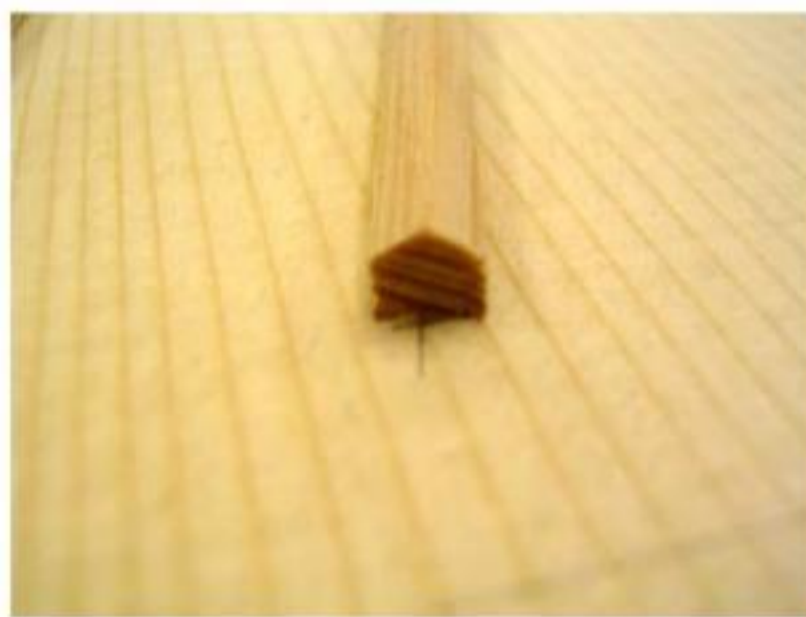

*Once I had successfully made all the braces gable shaped, I then tested the soundboard by flexing the braced area on each brace to test if there would be enough movement in the whole area to give volume to the vibrating strings.*

*It was felt that the soundboard still seemed to be a bit rigid due to the braces being made from Douglas Fir Spruce and so I then attempted to take the braces down to a 3mm height instead to allow more flexibility.*

*Sadly I began to lose the gable shape of the braces at this point perhaps due to the chisel not being sharp enough and maybe also just having worked on it for too long. At this point I decided to opt for rounding the braces off.*

## Deciding to Round the Braces



To round them off I first planed them down to a more suitable height with the block plane and sanded the shape round with a small sanding block trying to gradually round away any flat edges on the braces.

This seemed to work not bad but I felt I wanted to make the shape of them a bit more consistent so I made a little sanding block with a channel in it. I did this by putting a full piece of MDF into the pillar drill hand vice, which I had marked out at both ends with a centre mark.



I drilled into it at one end using a 6mm forstner bit the size of which I thought would allow for 1mm of double sided tape and sandpaper when rounding the 5mm braces. I then turned it over and drilled through from the other side to try to meet the same hole previously drilled. To achieve this I made sure to use the depth stop on the pillar drill to ensure I didn't drill right through into metal of the pillar drill vice.



Once I had the hole drilled, I cut away a section of the mdf to just expose the length of the hole and then compared this to the height of the braces. Once I had an idea of what height to make the channel I block planed and filed it down to make it match what the braces should be. I then carefully double sided some 100 grit sandpaper into the channel to use it to round the braces.

This worked very well and they began to look not too bad again after my earlier mistakes. Afterwards I also added some sandpaper onto the 2 faces of the sanding block thinking it would help clean up the areas inbetween the braces as well which it did do not badly but also it made a couple of extra marks into the bargain!



At the end I went round all the braces and made a scallop to both ends of each to blend the strengthening properties into the soundboard a little more gradually. Afterwards again I thinned them all one more time as I felt they were still overly stiff. This time I tried to make them gradually get thinner as they moved out away from the central brace which I left the thickest.

## Putting Curve on Harmonic Bar, Gluing and Planing to Size



Having already glued on the harmonic bar above the soundhole (which was glued on completely flat) I was now able to work on the harmonic bar that goes beneath the soundhole.

For this brace I had to use the shooting board with the dowels in place to pull it back into a bow shape before planing it. Because the harmonic bar was quite a short length, I used two clamps. One clamp was to hold the shooting board to the bench and the other smaller clamp was to pull back the harmonic bar in the centre about 2mm.

Once I had clamped the harmonic bar in position, I planed the piece gradually flat and then compared it with the scooped area of the solera to make sure it matched up.



Once it matched I glued it in place with a length of pine underneath to protect the soundboard using 4 Cam Clamps instead of the Go Bar Press. Once it was glued I planed this harmonic bar back to about 16 - 17mm in height using the block plane.

I also planed the flat harmonic bar above the soundhole to about 20mm and then I scalloped both ends of both harmonic bars 50mm from the edge of the soundboard using a chisel.



Finally I sanded the scalloped areas and then used the chisel to shape both of them into a sort of archway shape when viewed from the side.



## Noting Finished Soundboard Thickness

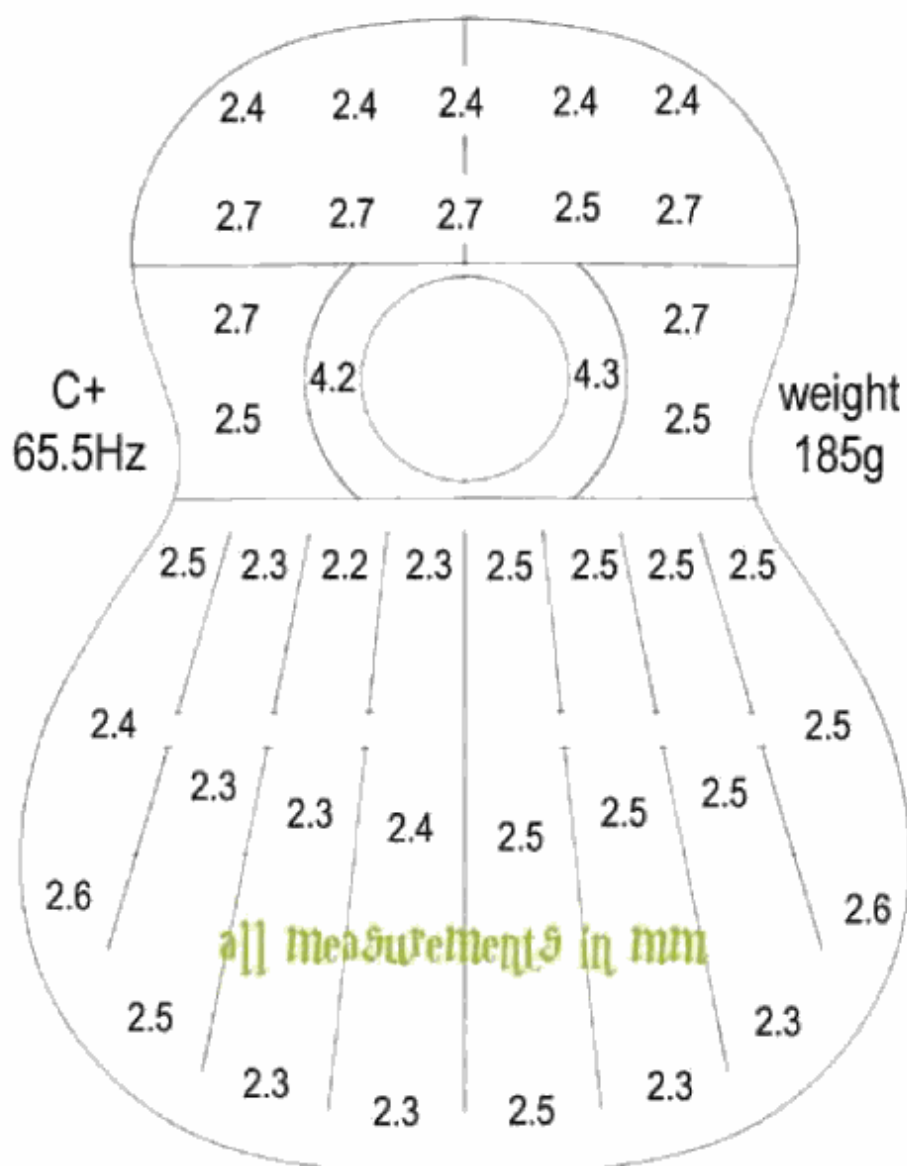

## Soundboard Thickness

*This was done using the Thickness Caliper measuring the areas inbetween the braces and around the soundhole patch etc. The note of C+ was measured with a computer program by tapping the soundboard next to a microphone plugged into it.*

## Noting Finished Brace Sizes

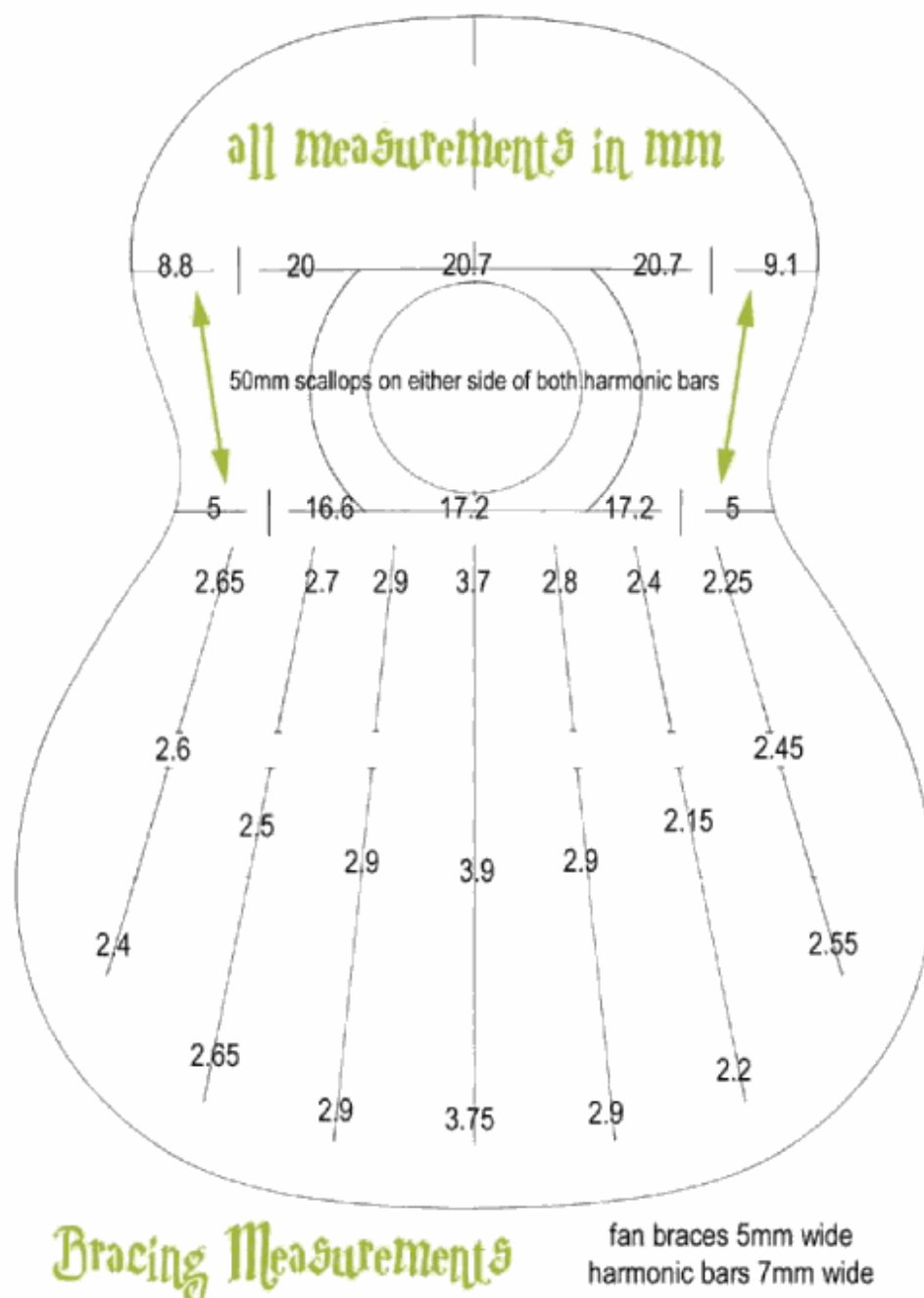

*These measurements were taken using the Vernier Caliper. Although the braces are definitely thicker in the middle and thinner at the outer edges, after measuring them I feel maybe they are not exact enough but by taking note of these measurements I will hopefully get a better idea of how they could be made on a second instrument.*

## *Guitar Back*

## *Cleaning Up Rosewood Back and Marking Out*



*To begin with I planed each half of the rosewood back to clean up the wood grain to allow me to see what might be the best way to join the two halves.*

*Once reasonably cleaned up I was then able to lay out the two halves and check the wood for any flaws or knots that might be better to leave out of the final guitar back.*

## Checking Template Fits for Guitar Back

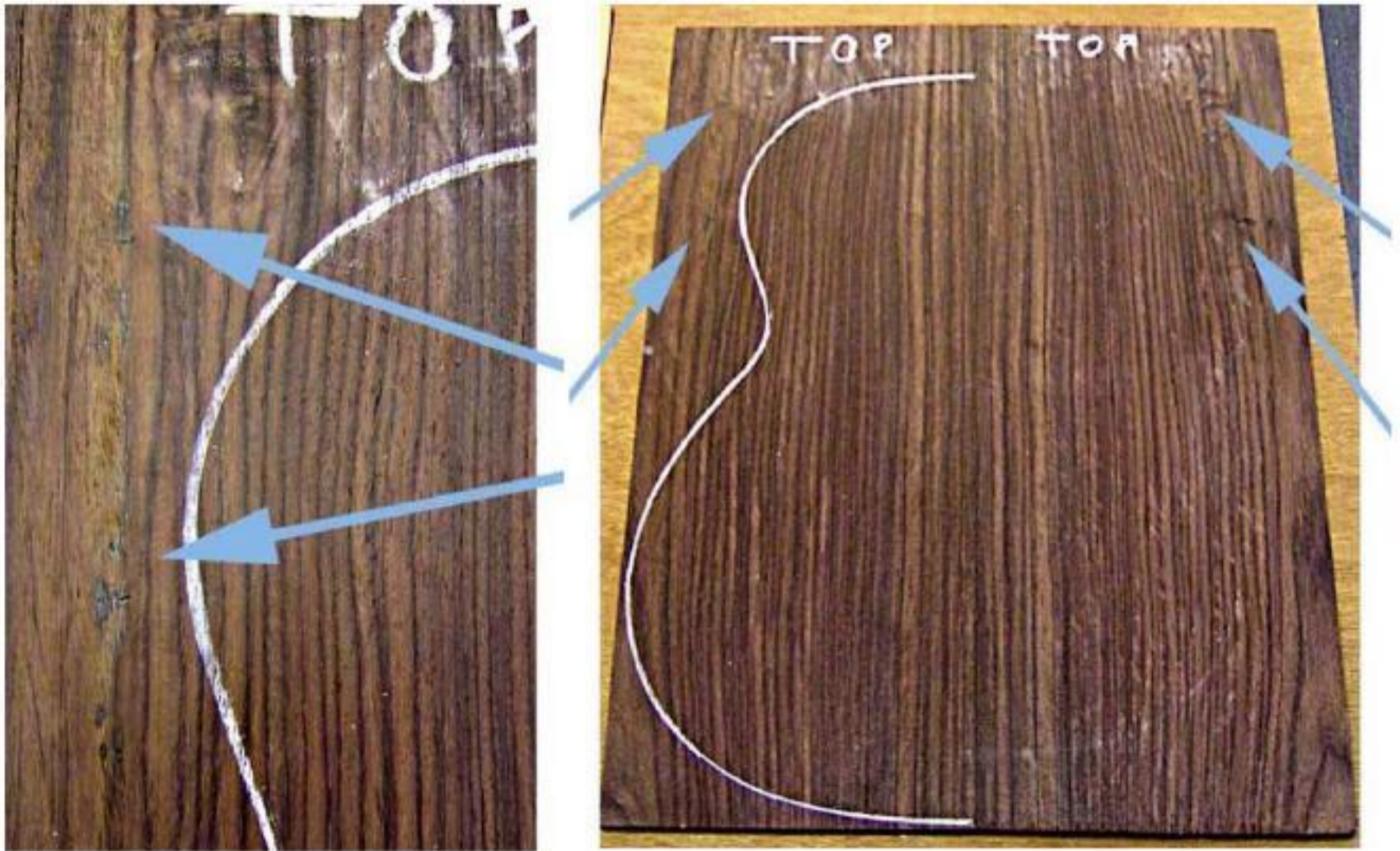

*After checking the wood I could see that there was a quite dense area in one of the top corners, perhaps a knot or some short grain where it had been very difficult to plane.*

*Working on from this I drew around the guitar front template, with chalk positioning the upper bout at the top of the wood so as to avoid this area.*



## Planing Edge of Guitar Back with Plane using Shooting Board



After deciding on which edge the two boards would be joined, I then marked out the wood in exactly the same way as I marked out the Guitar Front and used the a number 7 jointer plane on its side on the shooting board to plane down the edges of each board.



Again, the same as with the Guitar Front, I held the boards up to the light each time I planed the edges to check how closely the boards were fitting together. It was much more difficult to get a perfect join with the Rosewood Back, than it was with the Spruce Front, due probably to the hardness of the material. Also I realised the importance of having a good flat plane and a very sharp plane blade.

After a lot of attempts and a lot of help and advice, I finally got the two halves close enough to glue together. The process of gluing the two boards was the same as for the Guitar Front.

This drawing shows the traditional Spanish method for joining a back or top. A wooden wedge is used to tighten rope which holds the two halves of the work together on another wider wooden block). Using this method would save the need for buying expensive sash clamps and would also allow a number of soundboards or backs to be stacked up until ready for use.

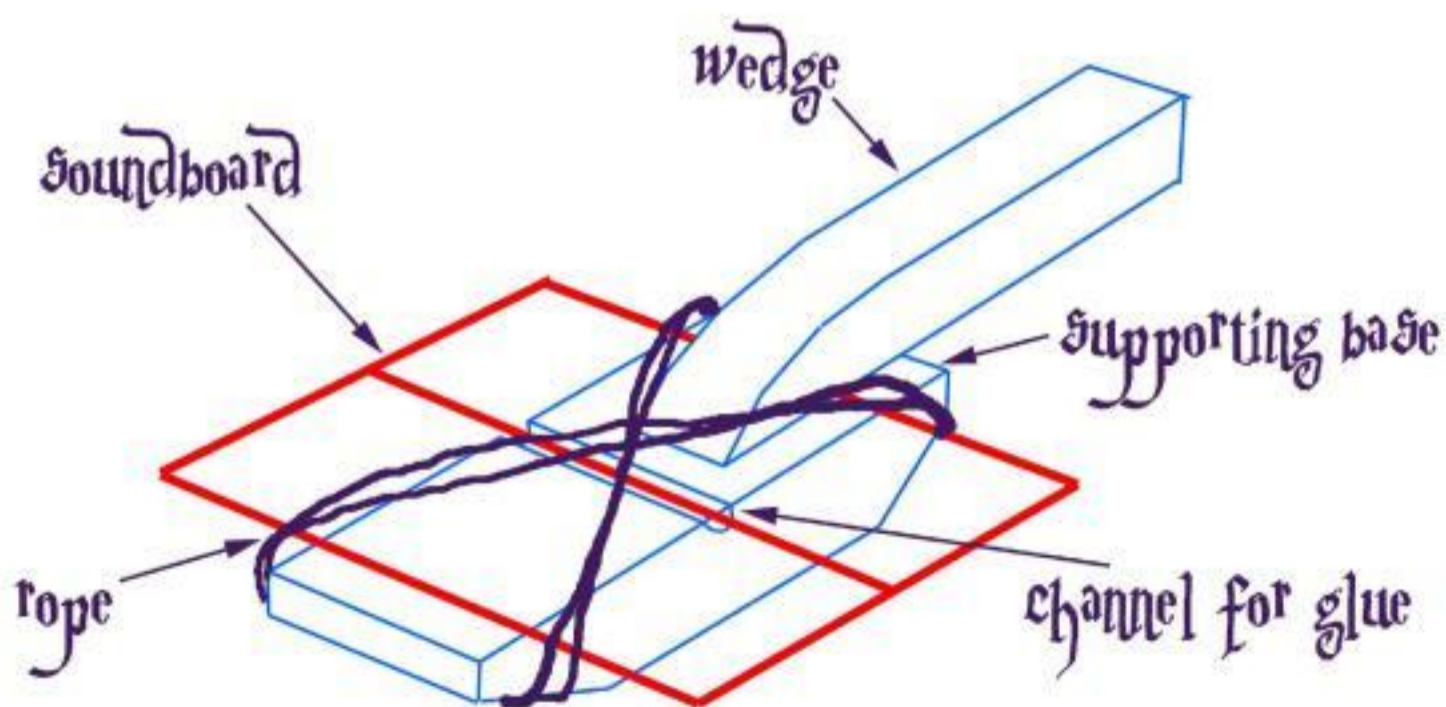

## *Thinning Guitar Back with Cabinet Scraper*



*At this stage I then started to clean up the best side of the guitar back with the Cabinet Scraper in order to make it as clean and smooth as possible. This is to make sure that when I go on to thin the guitar back to its final thickness, I already will have the outside ready without needing to take any more shavings off.*



## Marking Thickness on Guitar Back for Scraping



After having smoothed the good side of the guitar back with the cabinet scraper I began thinning the other side of the back taking my time to mark on the thickness every couple of inches with chalk using the thickness caliper, then walling off matching thicknesses by drawing a line around them to make it easier to see which areas needed scraped first. Once an

area, for example 3.1mm thick was scraped, I then moved onto any 3.0mm thick areas scraping them alongside the 3.1mm parts just previously scraped. This was to make sure I was gradually leveling out the thickness so that it was nearer to being ALL the same thickness.



I repeated this process and gradually scraped the rosewood back to an ideal thickness at this stage of between 2.6 and 2.7mm. I managed to make the outside face of the wood, the face which will be seen, quite smooth and free from blemishes, however the inside does have a few slight tears and scratches but these will not be seen and they are not likely to affect the sound.



## Cutting out Guitar Back and adding Centre Strip



With the back the right thickness I was then able to trace out the exact shape using the actual soundboard and then cut it out on the band saw trying to leave about 5mm extra all around the shape to allow for any change in size due to any warping of the ribs while bending and gluing.



With the back cut out I prepared a centre strip of spruce from the top of a spare piece of soundboard, the grain running in the opposite direction from the rosewood back. Before gluing I squared the edges using a long sanding block.

I glued it in place with titebond using a caul the same size made from some scrap pine and pressed it in place using go bars.



Once glued I planed the strip to about one and a half mm high and then using a long sanding block tried to curve the whole length. I also cleaned along the edges where it meets the guitar back with some fine grade sandpaper.

## Preparing Braces and Gluing to Guitar Back



The back braces need to be curved in the same way as the harmonic bar under the soundhole on the soundboard so again I set up the shooting board for this job. This time I clamped the whole shooting board to the bench with 2 clamps at either end which made the whole set up more sturdy when attempting to force the brace back to clamp it for shooting. For each of the three braces I had to use the Back Solera made by Bill to work out how much of a curve each brace needed. The biggest curve was around 4mm deep and the other 2 were a little less. It took a few attempts to get each brace sitting down into the hollow of the Back Solera but finally I managed to get them all close enough. Important here was to remember to have the plane blade as



square to the shooting surface as possible as planing the wood at an angle could cause the brace to be skewed when glued to the guitar back.

Once the 3 braces were curved I then took each brace and marked with pencil where they would cross the centre strip on the guitar back. I then scalpeled inside these markings freeing up the area to be chiseled out. A mistake I made here was in using the engineers square set against the centre strip to mark the scalpel line as the centre strip may have been glued a bit off centre. Instead I should have followed the brace position markings I had already made on the back to keep everything in line. After this I chiseled out each of the 3 areas where the braces would fit into.

With the Back Solera in the go bar press I was then able to glue each brace in position using titebond again and cleaning away excess glue as I went along. While doing this some of the areas appeared not to be sitting flush and this may have been due to the gluing surface of the brace being slightly skewed. I corrected this as much as possible by repositioning go bars to exert force more in the direction of the area not quite meeting the guitar back. This seemed to correct the problem to a certain extent but next time I would try harder to make sure that there is no skewing of the braces before gluing.



## Finishing Back Braces



With the braces glued in place I first cleaned up the tops of each brace using the block plane and made them around 15 to 17mm high in the centre in accordance with the plan and checking for flatness using a straight edge.

Once this was done I began shaping them into an arch shape coming to a point in the centre using a sharp 5/8 inch bevel chisel. Important to note here was grain direction, as in certain directions I seemed to be getting some tearing out. For each brace I chiseled one side right to left and the other left to right. Once chiseled I used the long sanding block to better form the arch shape and tidy up each brace.

After this each brace needed to be scalloped about 55 mm along from the actual guitar back edge down to a height of about 5mm. Again I cleaned up each scallop using some fine sandpaper and afterwards just tried to make sure there were no glue marks anywhere as these will show when looking through the soundhole.



## *Guitar Sides (Ribs)*

## Beginning Planing Guitar Sides



*Firstly I clamped the rosewood guitar side (rib) down to the bench with 2 clamps to secure it and started planing at a 45° degree angle to the board.*

*It took me a few attempts to find the correct direction to go in where the plane seemed to be cutting more smoothly.*

*When I worked out the direction and angle I marked it on chalk and mirrored this guide mark onto the other board.*



## Planing Guitar Sides



Once I had planed the sides roughly, I then began to use the thickness caliper to start to gauge how thick the rib was and marked each reading with chalk.

The distance between each thickness reading was about 2 inches so when I had marked up a whole side I then began thinning the rib with a plane.



I tried to make sure I was planing the thickest levels firstly and then the next highest levels alongside those that I had just planed in order to ensure I was bringing all the levels down to the same thickness gradually.



At this point it started getting a bit complicated looking with me choosing to draw chalk contour lines around matching amounts. This did help me though to understand what areas were thickest and needed planing firstly.



## Thinning Guitar Sides with Cabinet Scraper



Once I had planed the rib down to around about 2.6mm, it was time to move onto using the Cabinet Scraper to refine the thickness.

Again I continued to use the thickness calipers and marked out the rib with chalk.

With the cabinet scraper I felt like I had a lot more control in thinning specific areas than I had done with the plane.



It was easier to target the thickest points on the rib and scrape an amount of material away and then scrape the next thickest alongside the area just scraped.

Gradually the ribs began to get closer to the final thickness of 2.2mm.



## Thinning Guitar Sides with Cabinet Scraper



*It was difficult scraping the sides and I spent a lot of time chalking out the wood to make sure I knew which areas were highest.*



*Finally after a combination of marking and finely scraping the areas that were the thickest, I managed to get the ribs down to between 1.8mm at only a couple of the edges to mostly 2.0, 2.1 and 2.2.*



*Here are the ribs complete and ready for the next stage. The inside faces of the ribs are a little bit rough but because they will be on the inside of the guitar so it shouldn't matter too much.*

## Preparing the Guitar Sides for Bending

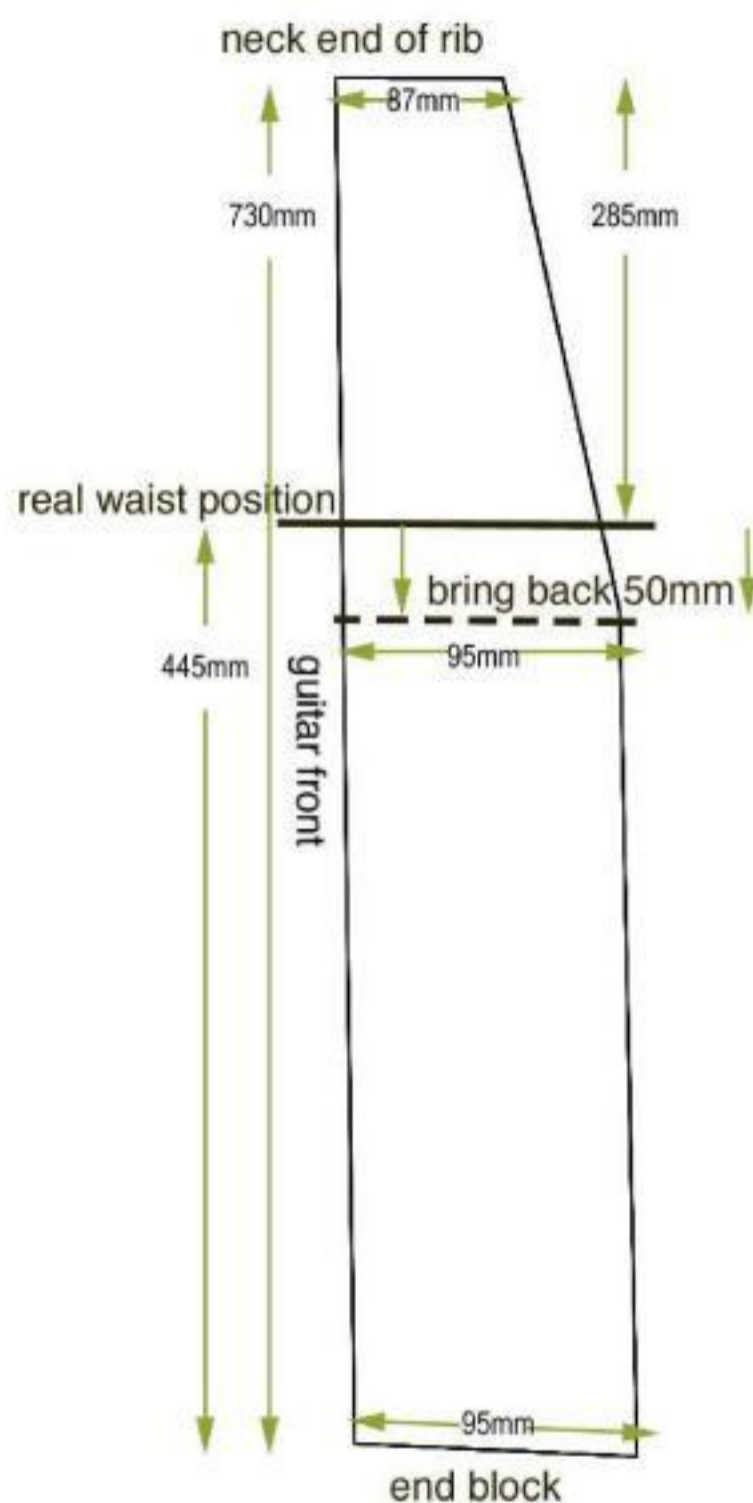

With the Ribs at about 2.1mm overall I marked them out the same as the illustration above on the right. The Sizes of the Rib were marked out from the middle of the rib to allow there to be extra wood on either end in case of error in measuring. To get the measurements I used a Guitar String and ran it along the edge of the soundboard until I reached the waist point and took note of it. I then measured the entire side and took note of this. The measurement from the End Block to 50mm before the Waist position stays a constant 95mm wide and afterwards tapers towards the neck join end of the rib. The constant 95mm is to allow enough extra material on the rib to allow for error when fitting the back of the guitar.

To plane one edge straight I used a special long shooting board to account for the long length of the ribs. The clamps held a piece of mdf on top of each rib on the shooting board and clamped the whole assembly firmly onto the bench to keep the work straight while shooting the edge with the number 7 Plane.

## Bending the Guitar Ribs

Once I had made the flat edge on the 2 ribs that will be glued onto the soundboard, I trimmed off the excess wood along the length on the Band Saw remembering to leave intact the extra wood at both ends. I also was advised to add on 5mm to the edge which will be glued to the back and this was good advice as the Band Saw broke the Rosewood up quite a lot and it was hard to keep to the pencil line. With the extra 5mm this was a good safeguard.



With the Side Bending Iron at full power for 20 minutes, I began to bend the sides a little at a time, comparing inbetween bends to an exact tracing of the soundboard on a piece of mdf just beside me.

All in all it seemed to go quite well apart from maybe some twisting which happened along the way. I realise that it's important to keep the rib totally horizontal and also to try to keep the rib supported from behind when pulling towards the bending iron to keep the bend consistent along the width. Having taken a full day to do the first bending of the sides, I

feel they are now ready to be fine tuned more exactly to shape and perhaps I will also manage to get some of the twists out with the second attempt.



## *Second Bending of the Guitar Ribs*



*The second bending about a week later seemed to go quite well. It felt as though the rosewood was bending more easily and it seemed to not take as long to get them close to the shape of the soundboard.*

*There were a couple of twists in the sides which seemed to match up on both pieces of wood so this was thought to be a characteristic of this particular set of ribs more than it being a problem with the process of bending.*

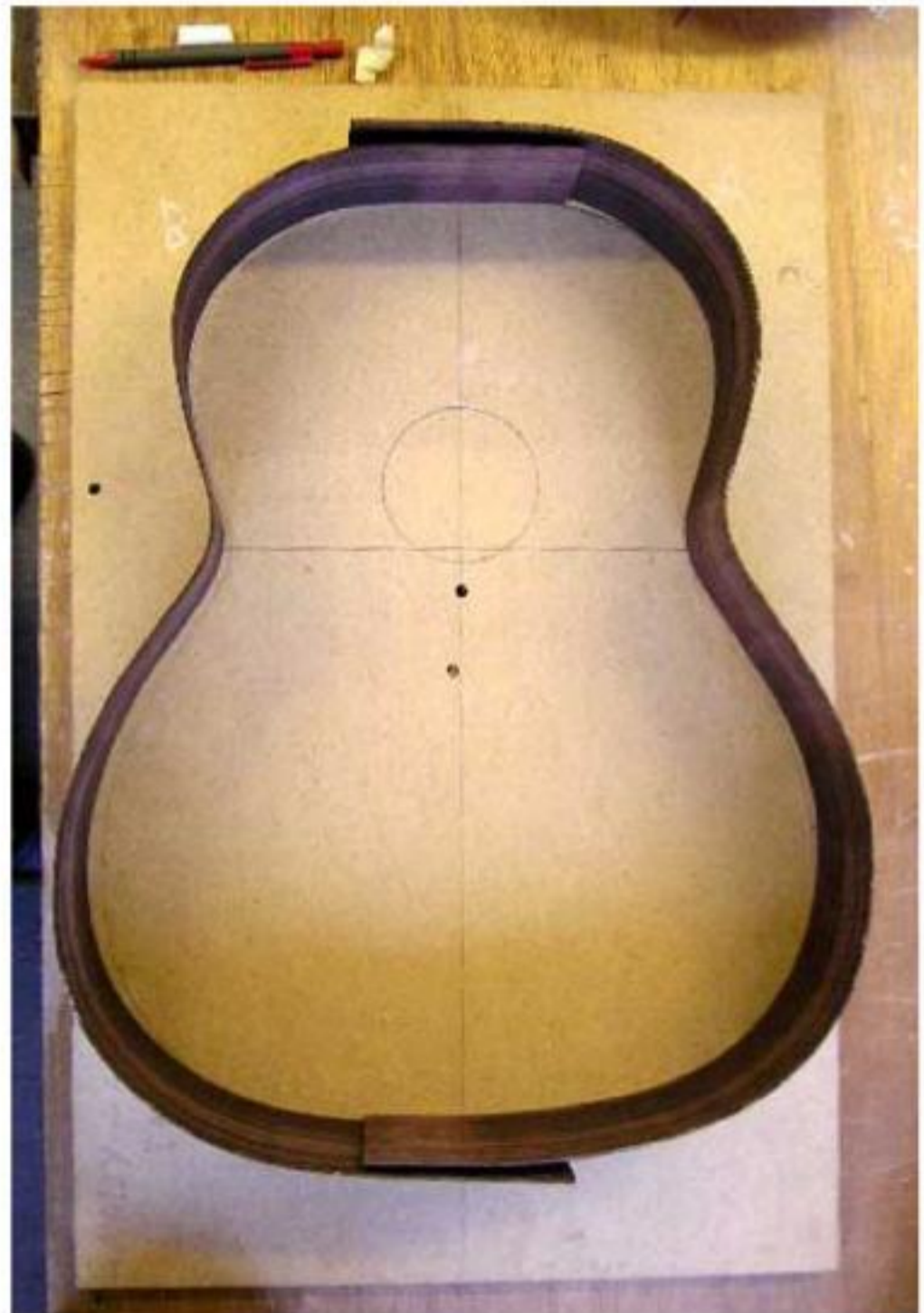

# *Guitar Neck*

## Planing the Brazilian Cedar Neck Blank



*The Neck Blank needed to be planed to make the surface completely flat and even. This is the surface on which the Fingerboard will eventually be glued. This was constantly checked using a straight edge along the length and from corner to corner. This took quite a bit of time to get right.*



*After getting the first face even, it was then important to get the sides level in relation to the first face.*

*At this point there was a lot of checking along the edges with the try square to make sure there was no light getting underneath and checking all the way along to highlight the areas that needed to be planed.*



*Also important here was to make sure that the width of the neck blank was kept the same all along the length. This was checked using the Vernier Caliper as shown below in the left image.*

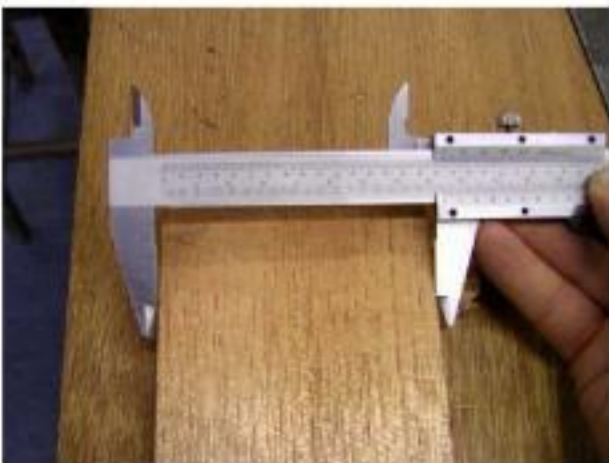



## Planing the Cedar Neck Blank



For the final edge I placed the neck blank on top of a piece of mdf on top of the shooting board to make sure I had a very even surface to lean on whilst taking the final shavings off as I was getting very close to the 80mm limit for the width the neck will have to be at the headstock end.

Once I had achieved my 2 edges in relation to the first face, I then used the marking gauge to mark the final thickness of 19mm on the neck blank and then planed this carefully down towards this target.

This is a close up of the grain of the smooth planed cedar neck blank showing some medullary ray lines.



## Cutting the Neck Scarf Joint

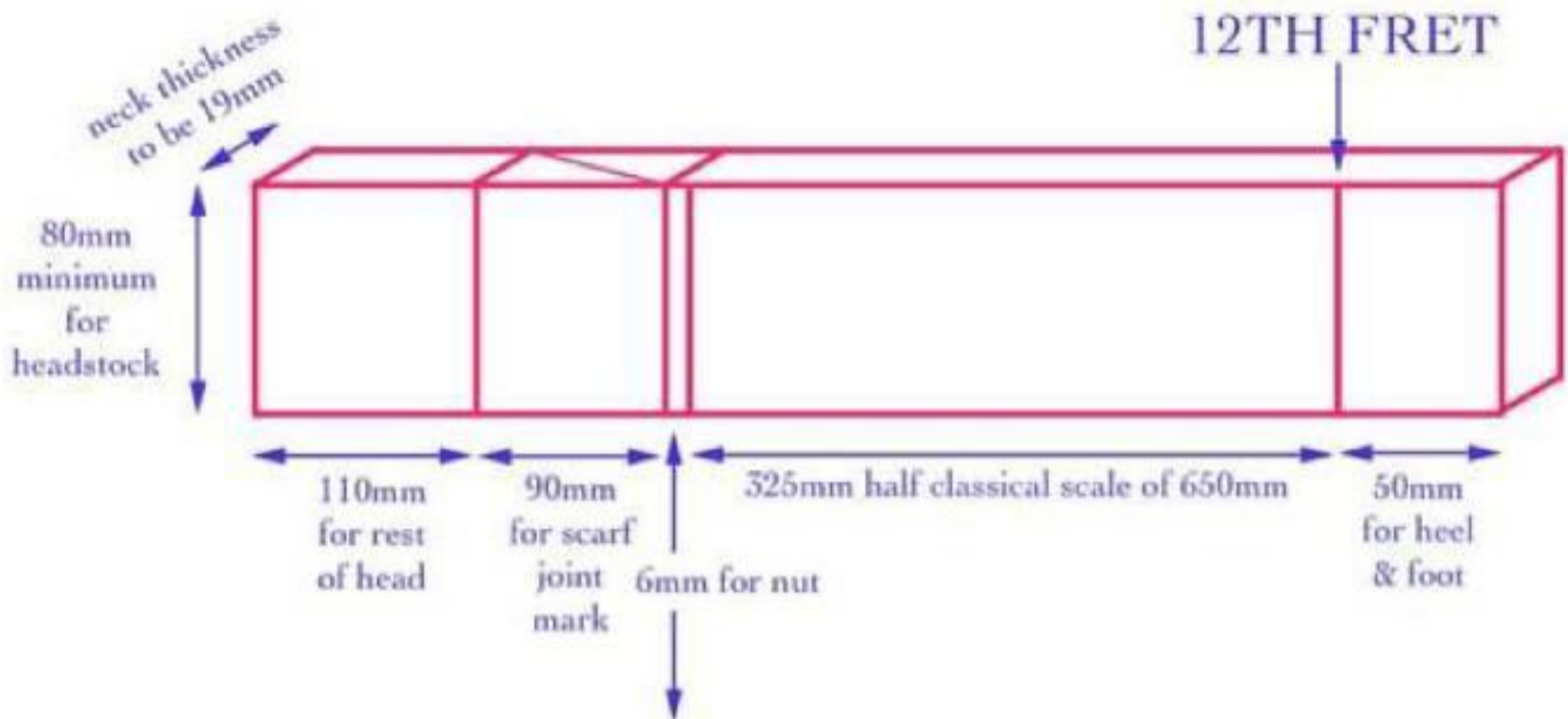

*With the neck blank clamped firmly in the vice, I used a tenon saw to cut down the line for the scarf joint, always keeping an eye on the lines drawn down the sides to make sure I was cutting in as straight a line as possible.*

*After reaching the half-way point, I turned the neck blank over and started to cut just the same from the other side towards the centre.*

## Planing the Neck Scarf Joint

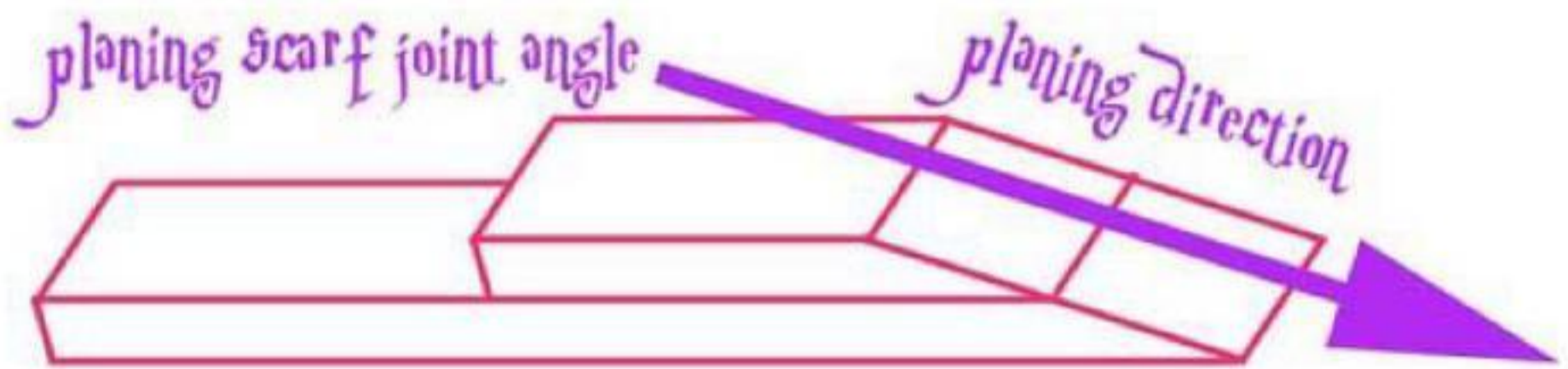

*After cutting the scarf joint, I placed the two halves together as in the above diagram and clamped them firmly together in the vice with the bevel lying horizontal.*



*I planed across both pieces of wood and gradually evened out the surface of the two halves to be joined. This took a bit of time and effort, again checking with the try square for flatness with every plane shaving.*



*Checking to make sure Neck Scarf Joint is Square before Gluing*

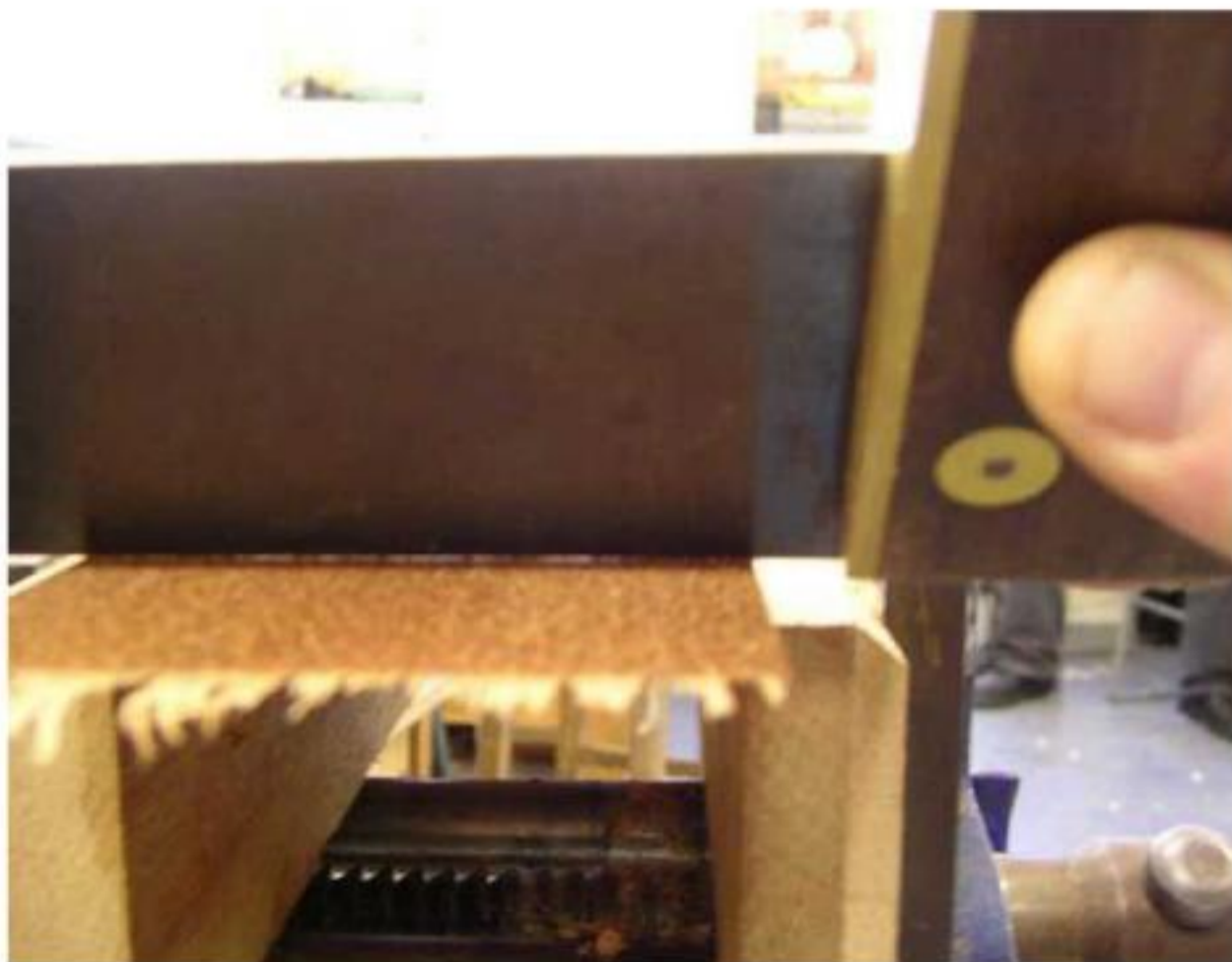

*Checking the scarf joint faces for flatness across the width.*



*Checking both separate faces of the scarf joint from corner to corner.*



*And checking flatness along length of two faces to be joined.*

## Clamping and Gluing Neck Scarf Joint

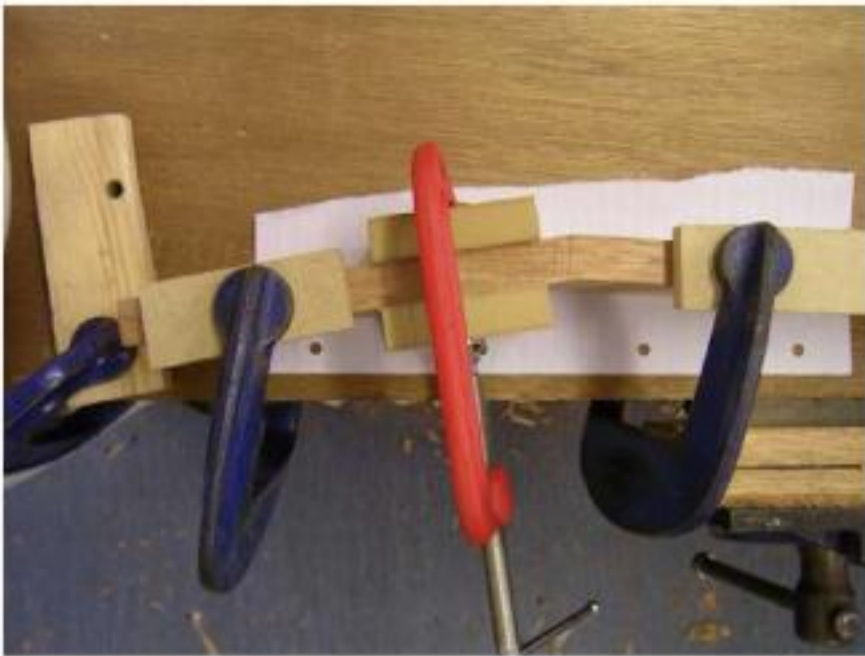

*After flattening off the two halves, I tested out how I might clamp the two halves together on the bench to make sure I had it right before going on to the gluing stage.*

*Once satisfied the clamps would hold the scarf joint securely, I went ahead and applied glue to one half of the wood.*



*I then placed the two halves together making sure to put a piece of paper between the area to be glued and the bench.*

*I then tightened all the clamps up to make sure the wood was held securely and left the scarf joint overnight for the glue to completely dry.*

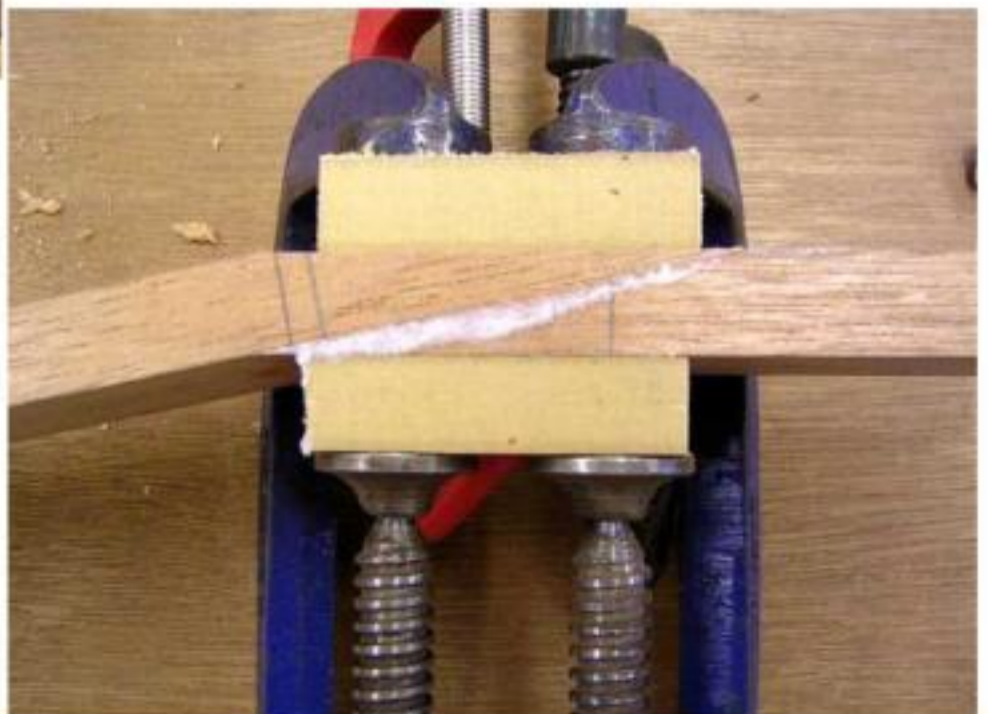

## *Adding veneer to Head*



*Neck Scarf Joint Completed.*

*At this stage I chose 4 veneers to glue onto the front of the head which will be quite nice visually once the slots for the tuning pegs are cut out. I chose a thicker rosewood facing followed by a light coloured wood then a mid colour almost like the neck itself, then ebony for the final lowest veneer.*



*I glued the 4 veneers together separate from the guitar neck and allowed to dry overnight and then once they were dry, I glued them to the front of the head as shown on the left. Below is a detail of the overall effect.*



## *Cleaning up Veneer at Nut and Planing it down*



*Once the veneers were glued and dry I took off the excess edges of veneer with the Band Saw then planed the edges as close to the guitar head as I could without removing any more material from it.*



*Using the try square I marked with pencil on the rosewood veneer the point where the nut will be placed just after the headstock making sure to check from both directions that the mark I was making was square to the neck.*



*Once square, I used a blade to mark on the line and then used a Gent Saw to very carefully cut down towards the neck, stopping just on the final veneer and using the blade to cut finally through.*

*To tidy up I placed masking tape on the neck at the nut and used the rough edge of a flat file to square up the edge which the nut will sit against.*



*The top rosewood veneer was a bit unevenly thickened so I marked on an overall depth for the headstock with the marking gauge of about 22mm and gradually planed towards this.*



*In the end, because I had made a few tears in the wood, I had to plane it a little thinner than hoped - between 20 and 21mm.*

# Shape Plan for Slipper Heel

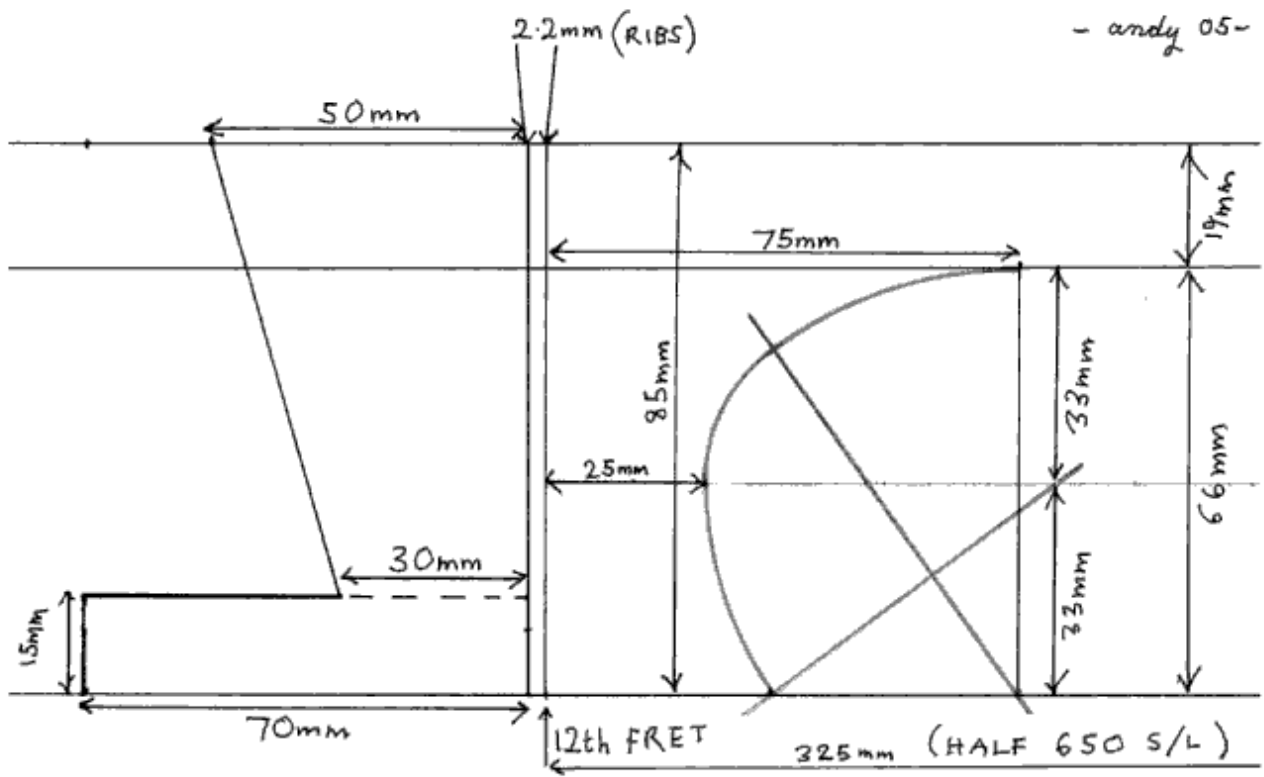



## Planing down Remainder of Neck Blank to make Guitar Heel

I began to plane down the wood for the heel to get the main face completely square from all angles and then done the same with the 2 sides and then the remaining face. This was to make sure all pieces of wood for the heel would join seamlessly.



I drew a plan to make sure I would join the pieces for the slipper heel in the correct order. Once I had done this I realised I was a bit short on wood so I then had to get an extra piece which matched the cedar of the neck. I then squared this piece in similar fashion to the first but only on one face and the two edges as I would be cutting off the bottom edge eventually.



I cut out my plan and laid it onto the blocks before gluing to make sure I had the right alignment for each block then I drew a line down the blocks as a guide when gluing.

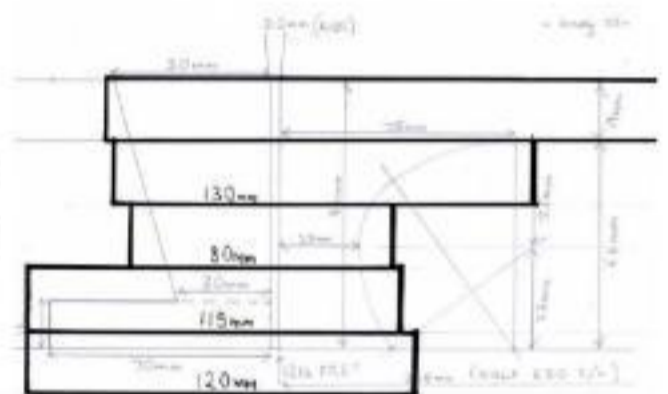

Using two blocks of wood as cauls to protect the wood, I laid all the pieces side-on on the bench and got 4 clamps ready to put in place. I then applied glue to each block in turn making sure the pencil guide line was staying straight and then began to tighten all four clamps one by one and tightened them all again a bit more to make sure.



## Planing Sides of Guitar Headstock



I clamped a steel ruler onto the guitar neck to extend the centre line along the headstock.

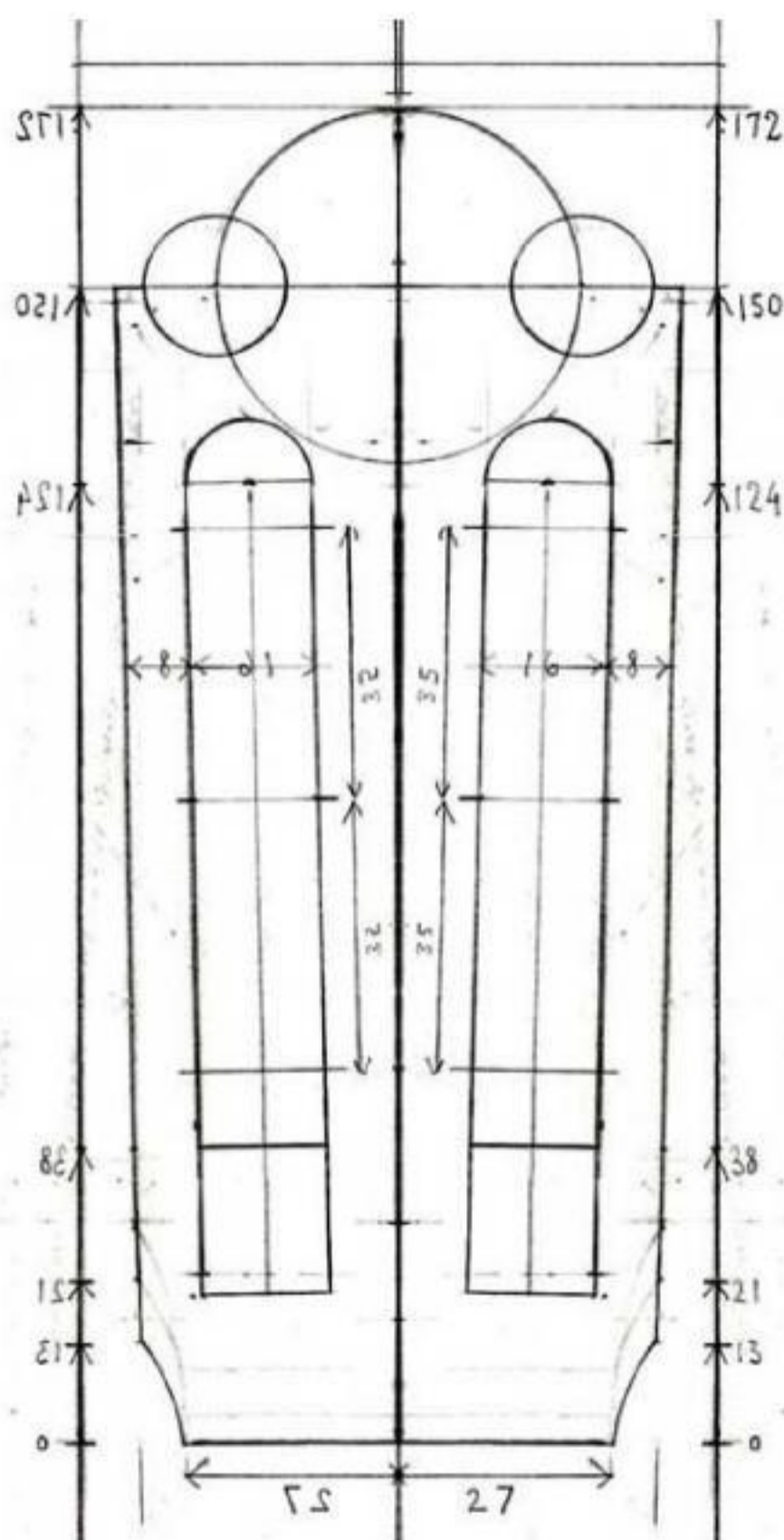

After getting the centre line I was able to draw on the half template I made. I decided on a design by merging together what I thought was the best of three headstock designs by 4 different classical guitar makers Antonio de Torres, Santos Hernandez, Hermann Hauser and Roy Courtnall. I like the way on a Hermann Hauser guitar, the slots are squared at the bottom and rounded at the top.

## *Planing Sides of Guitar Headstock*



*After drawing on the headstock shape, I drew on the dimensions of the actual neck with pencil. The sizes were 54mm at the Nut end widening to 64mm at the 12th fret which is where the neck will join the body of the guitar.*

*Once I had the neck marked out, I was able to cut away 2 small sections about 140mm in length on either side of the neck just below where the headstock begins. This was to allow the block plane access for planing down the sides of the headstock which slope towards the neck.*

*After this I planed the sides of the head with the block plane using the pencil lines I had drawn on with the headstock template as a guide. I added in masking tape to highlight this line to make sure I kept my eye on how much I had left to go. Always along the way with this I kept checking with the square to make sure, I was keeping it straight and square as possible. This is to make sure the machine heads operate smoothly when they finally are attached to the headstock.*

*After planing the 2 headstock sides I tidied up the area where it curves down towards the neck.*

## Cutting Out Design at top of Headstock



After getting the sides of the headstock sorted out, I then moved onto cutting away the design at the top of the headstock.

After just starting chiselling I decided to clamp on an mdf block behind the head to make sure I didn't split the grain of the wood and this helped a lot. I also drew the

headstock design on the back of the head by projecting the pencil lines on the front face along the sides and onto the back.



I took my time mostly using a sharp 5/8 of an inch bevel edge chisel to carefully take away small amounts of wood while always checking back and forth to make sure I wasn't chiselling past the guide lines I drew on.

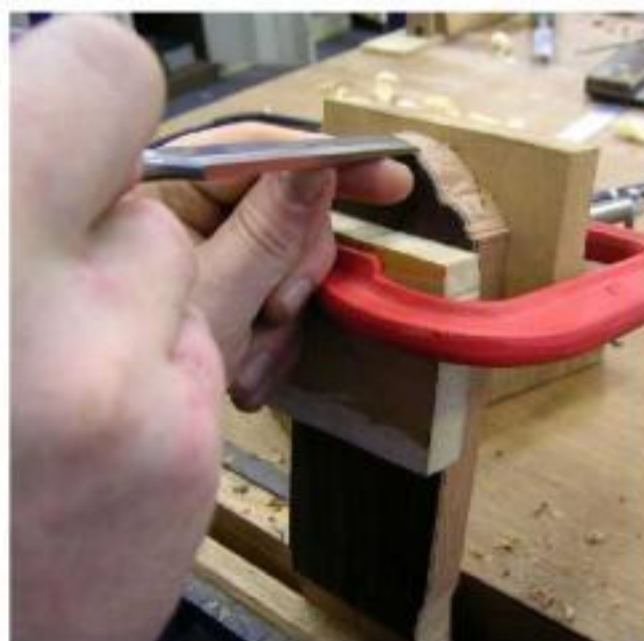

Once I had the headstock almost right I moved from the chisel onto using a small flat block of wood with sandpaper fixed onto it to lightly flatten down some of the bumps.

Unfortunately at this point I noticed the nice end-grain becoming all clogged with dust from sanding but hopefully this grain will come through again once the guitar is finished.

## Drilling the holes for the Machine Head Rollers

With the headstock shape completed I was able to go on to drill out the side holes for the machine head rollers. These were to be drilled using a 10mm Brad Point drill bit on the pillar drill. The pointed part in this type of drill bit helps guide it slowly and more accurately into the wood and so makes it less likely that the bit will veer off course. The holes themselves were to be 35mm apart exactly. This is the standard distance apart between the centre points of machine head rollers.



To protect the headstock I put two batons of scrap plywood either side and then placed it into the the hand held engineers Nippy vice. With the 10mm brad point drill bit in place in the Pillar Drill Chuck, I used the small engineers square resting on the side of the headstock to check the alignment in relation to the drill bit.



Once the headstock was aligned and tightened into the engineers vice, I had to adjust the depth stop on the pillar drill to make sure it was only going to drill down to about the half way mark through the headstock at the narrowest end of it. This first hole at the narrowest end nearest the nut and the hole on the opposite side would likely both run through into each other.

I managed to make a mistake on the 3rd hole but noticed soon enough not to go too deep. I left the mistake for now and continued to drill the 3 holes on the other side before going back to try to fix the mistake. 5 out of 6 isn't too bad for a first attempt.

## Mistake with one of the holes for machine heads



I think my mistake in this instance was that I had marked on the points to drill with the tip of a compass and so had left a deepish mark which the brad point bit must have been pulled over into when drilling. Michael had said not to put a heavy mark on and I now realise why. When doing this again I will put a light pencil mark and not make an indentation in the wood. Luckily I saw it happening and stopped drilling after only about 2 - 3mm into the wood.



To fix this I had to first make a dowel from matching wood to make a small plug to glue in place.



I used a piece of the same wood and cut out a squared section with a length of about 10cm with the grain following the same pattern as the hole on the headstock. I then shaved this all along the edges to round it using the block plane upside down in the bench vice.



After rounding the block I then malletted it gradually through a series of holes cut out of a piece of Flat Steel until I gradually arrived at a dowel which more or less exactly matched the size of the 10mm hole in the headstock. I then refined the dowel using a sanding stick to get it more close to a cylinder shape.



Once this was done I glued it in place, making sure the end grain followed that of the side of the headstock and left it overnight to dry fully.

## Re-drilling plugged machine head roller hole



Once the dowel plug was dry I cut off the excess using a sharp chisel working it closer and closer to the surface and finally very carefully bringing it flush with the headstock.

This is a close up view of glued in dowel. This is not a bad mistake to have made as this area will be underneath the machine head side plates so it will not be too obvious. After this I marked out where the hole should have been making sure that it was 35mm apart from the centre hole and 70mm from the first hole, and also that it was exactly at the halfway point between the front and back of the headstock side including the extra which the veneer adds on to this size.



Once marked on I then set the headstock up as before and drilled it out once more.

This time it worked out fine and the mistake is not really too noticable now as most of the plug has now been drilled away and all that remains is a slight crescent shape at the side of the hole.

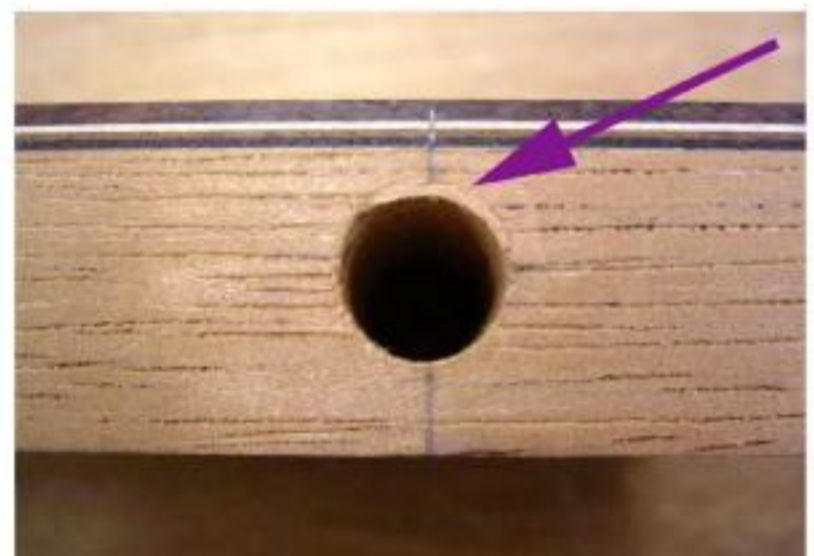

## Drilling Out the Guitar Headstock Slots



The next part was to drill out the string slots on the front of the headstock. Initially I had drawn out the markings on the back of the headstock but decided it would be better to drill from the front in case of any wood breakout on the rosewood front when drilled from behind.

For this the Pillar drill needed to be set up with a jig consisting of 2 pieces of mdf. The bottom piece of mdf was to rest the headstock on and the second piece was to act as a guide for keeping the side of the headstock in alignment with the drill bit. These two pieces of mdf once aligned were then clamped into position on the Pillar Drill Table using a G clamp.



The drill bit I needed to use for this was a 16mm Forstner type. This type is best at taking away large amounts of wood and leaving a nice clean surface and because it cuts flat at the base of the cut, there is less chance of any wood breakout when the bit breaks through.



Once everything was set up I clamped the headstock in place for the first hole and then drilled the hole a little at a time allowing the wood to escape every 5mm or so of plunging. I then did the hole at the far end of the slot the same always clamping down the headstock inbetween to make sure it didn't move. Then it was a case of drilling out the area between the first two initial cuts at either end, always trying to make sure that the pointed end of the Forstner bit was biting into the wood. After the slot was roughly cut out I then went along it with the headstock not clamped and plunged down all the spaces inbetween to clean the slot up further.



## *Drilling Out the Guitar Headstock Slots*



*I then repeated this process on the slot on the other side but had to turn around the jig on the Pillar Drill Table to mirror the process coming from the opposite direction.*



## Cleaning out Headstock Slots



To begin with I clamped the headstock halfway in the vice and carefully tried to chisel and sand away the excess of the marks made by the drilling out process. I found it a bit difficult to see into the slots this way while sanding so I opted instead to clamp it flat to the bench and work over it to be able to make sure I could see into the slots as I sanded.

Also this way it seemed easier to make sure I was keeping the sanding blocks totally vertical and not digging in to the opposite side as easily. I kept sanding as carefully as possible all the time trying to make sure I was keeping the slot edges totally straight.



For the round corners of the slots at either end I made a sanding stick by doublesiding some sandpaper onto a piece of dowel and this helped keep the shape perfectly fine. This stage I feel went quite well and I found my own way of working before too long. These are the cleaned up Slots on the right.

## Carving the String Ramps on the Headstock



Next stage was the ramps which allow the strings to reach the machine head rollers on the headstock.



With the headstock clamped down to the bench I marked out with a pencil the dimensions and depth I would need to allow the strings access to the rollers. The depth was to be about half way down at the lowest end. I then scalped in these lines to try to keep the wood from splitting. The first chisel stroke I made almost dug straight into the nicely finished slots so I put two pieces of mdf into the slots to act as chisel stoppers near the end I was cutting from to prevent any damage whenever the chisel slipped again.



As I chiseled down I then realised I would have to continually scalpel the edge to break away the wood I was Chiselling out.



After finishing Chiselling I cleaned up the slot ramps using a Flat File followed by a specially made sanding block to try to bring the two lines of sandwiched veneer on the ramps into alignment with each other. Unfortunately I had made



two chips in the front veneer at the corner of the slot ramps while I had been Chiselling. Next time instead of scalpeling as I was chiselling, I would instead at the very beginning, very carefully cut down either side of the slots to the depth needed using a fine razor gent saw. This I think would make the sides of the ramps cleaner and free up the wood to be chiseled out and make the whole job much easier (see drawing below).

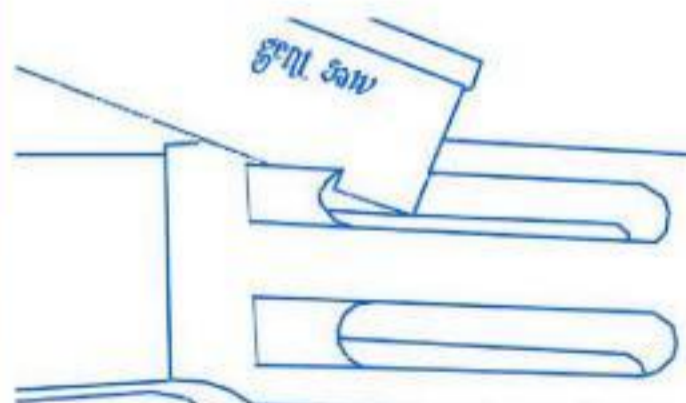

## Marking Out the Rib Slots on the Guitar Neck

To begin with I planed both sides of the slipper heel block with the block plane so that both sides were square with the top where the fingerboard will eventually be. This was to make sure that any measurements drawn on in pencil would be clear and accurate.

Once I had planed these 2 sides completely square with the top surface I then began to mark up the wood for cutting the slots which the curved guitar ribs will fit into.

To begin with I marked out the top face of the neck as shown in the photograph to the right making sure from comparing with the body template that this would allow for the curved angle at which the guitar ribs approach the rib slots.

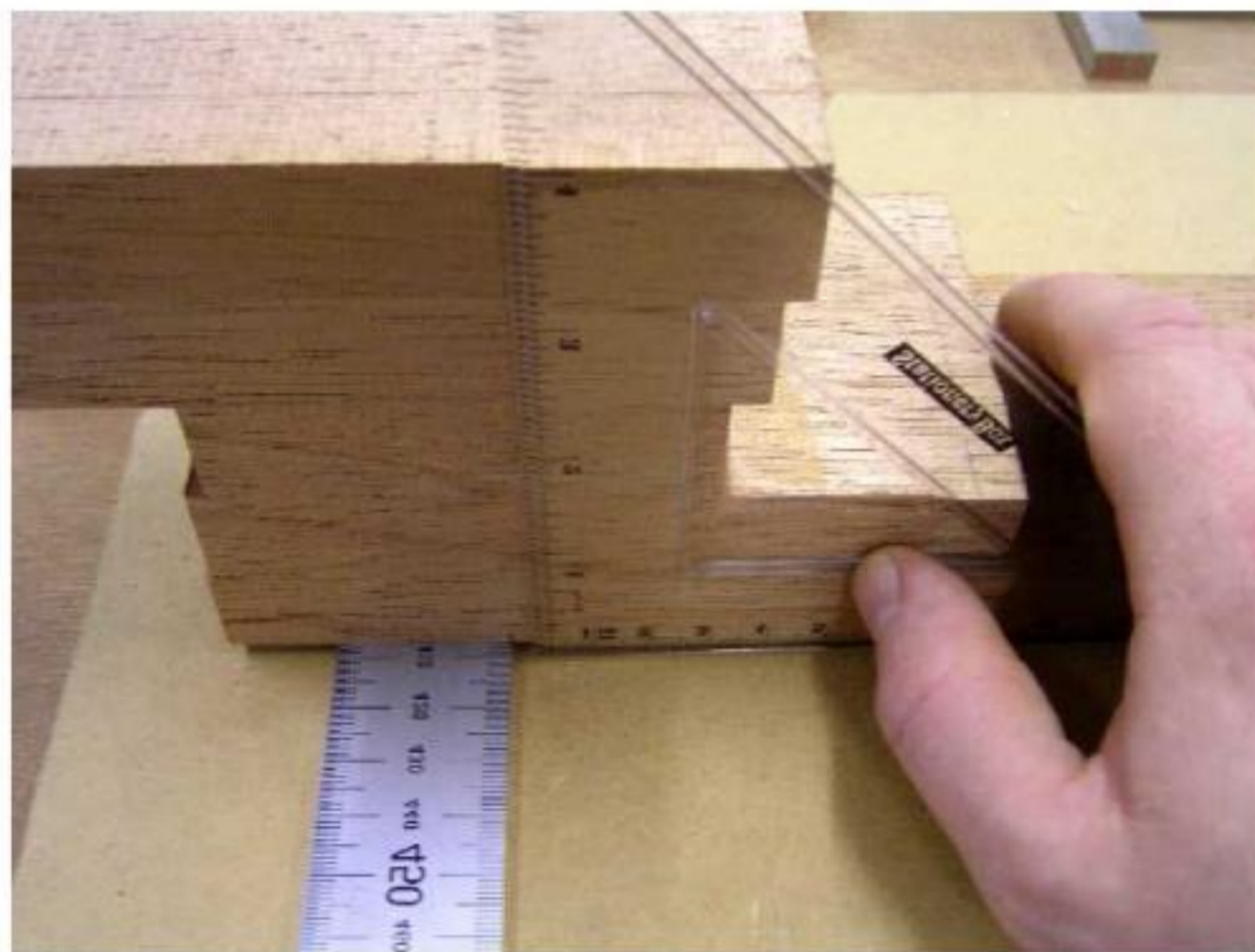
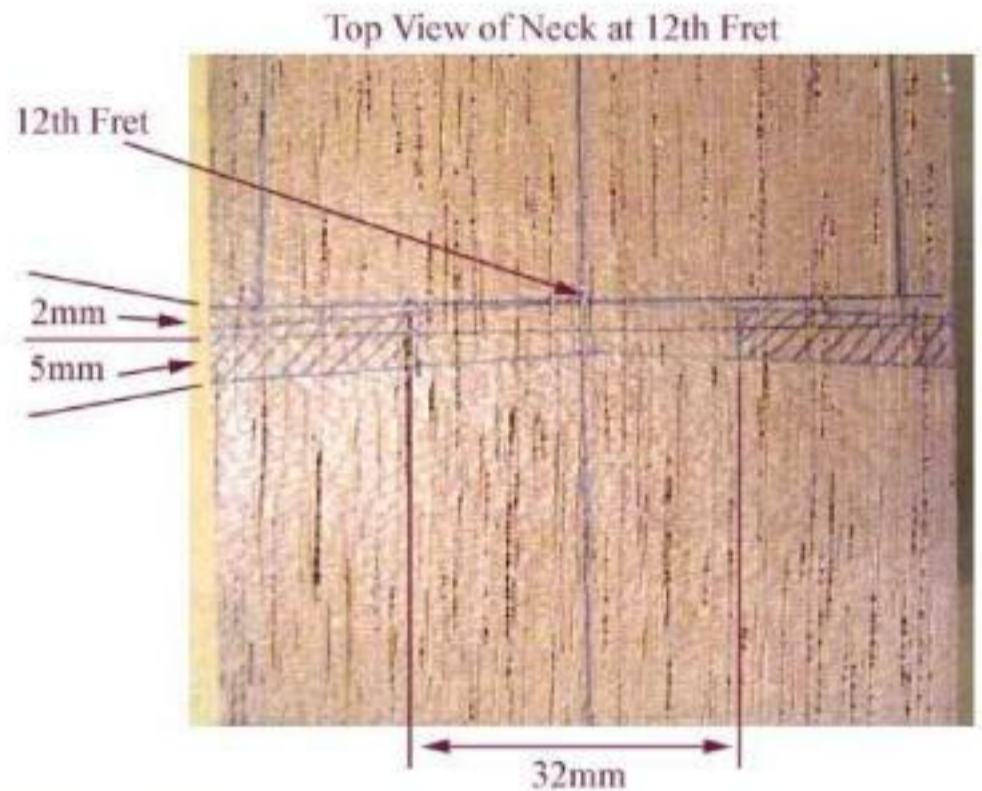

The angle of the guitar neck on a classical guitar is set to tilt slightly forward from the body so when marking the wood I had to remember to include this slight angle when marking out the position for the rib slots. To achieve this angle I placed the guitar neck top face down onto a flat surface making sure that the head veneer at the nut was not getting in the way. To give me about 3mm in height, I placed 2

Steel Rules directly underneath the neck on the bench as shown in the photograph to the left. Placing the Set Square flush with the bench, I drew a line in pencil up the side following on from the markings for the ribs I just previously made on the top face of the neck.

## Marking Out the Rib Slots on the Guitar Neck

Side View of Marked Out Rib Slot

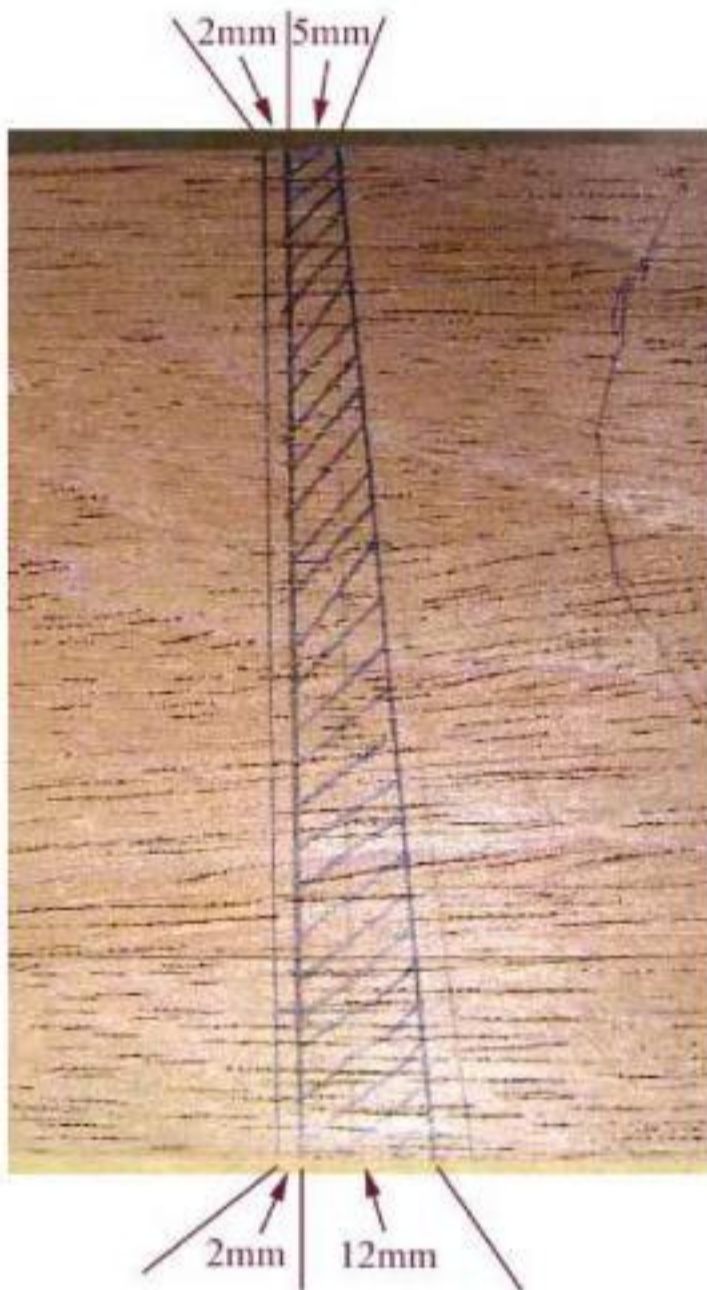

Once this initial line was drawn on one side with the correct angle, I was able to copy the angle for the second line down and for the two lines to be made on the opposite side using the Sliding Bevel.

Because a wedge will be forced down into these rib slots, the slots have to be cut at a taper which is wider at the bottom. This is because the guitar front will be face down when the sides are fitted and the widest part of the rib slot will be uppermost to allow the wedges to be driven into the position. The dimensions at the top and bottom of the rib slot can be seen in the image on the right.

Finally the lines from the side were continued onto the bottom of the neck heel block following the same method as before for getting the angle which the ribs meet the body. On the top the proportion of wood remaining in the centre was 32mm wide but on the bottom this is reduced to just 10mm as shown in the image on the right. This is because the Guitar Heel itself will become narrower at the bottom.

Point where Guitar Heel meets the body (ribs)

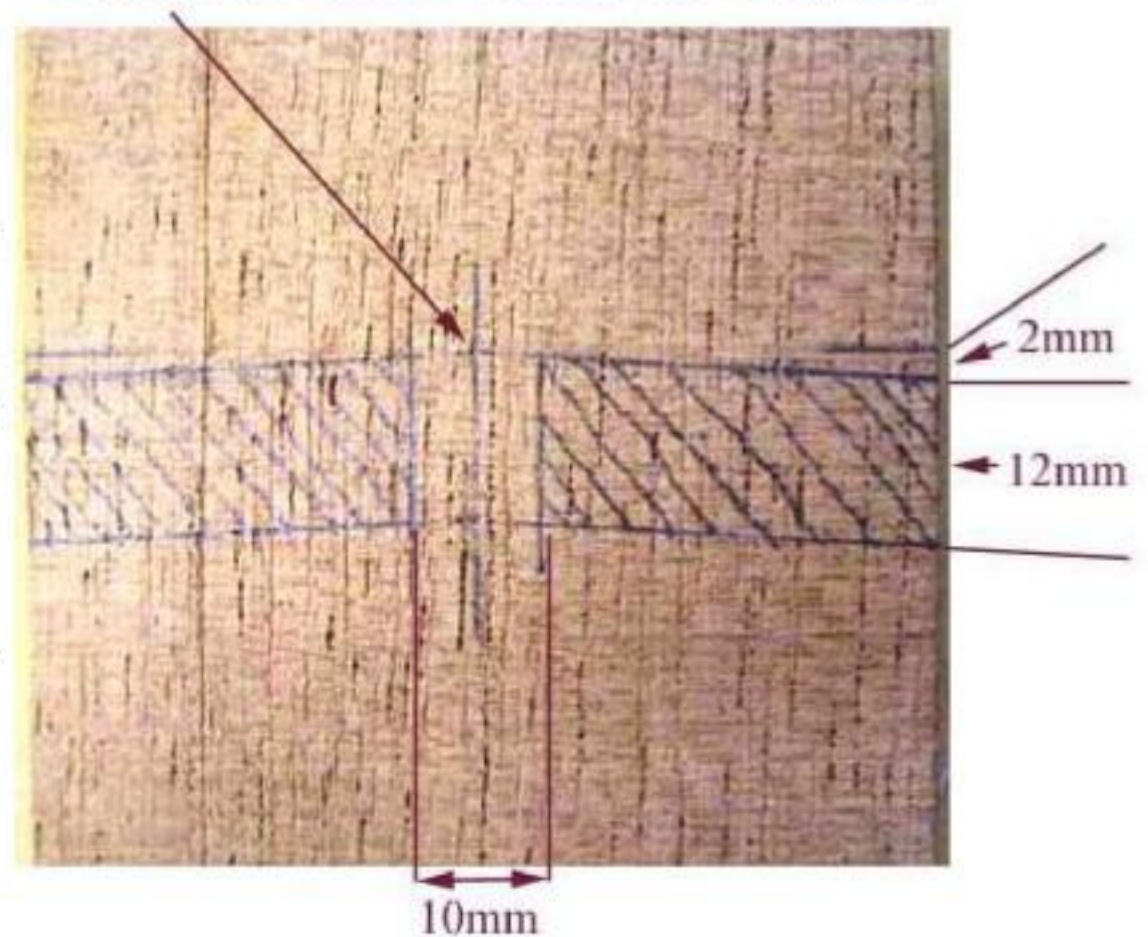

Bottom View of Neck at Heel

## Cutting the Heel Curves and the Rib Slots

At this point I decided to cut out the heel and inner block shape using the band saw initially to rough out the shape I had decided on. After this I used a quarter-inch chisel and a half-round file followed finally with some medium grade sandpaper over a jar to smooth off the saw marks from the cut out curve.

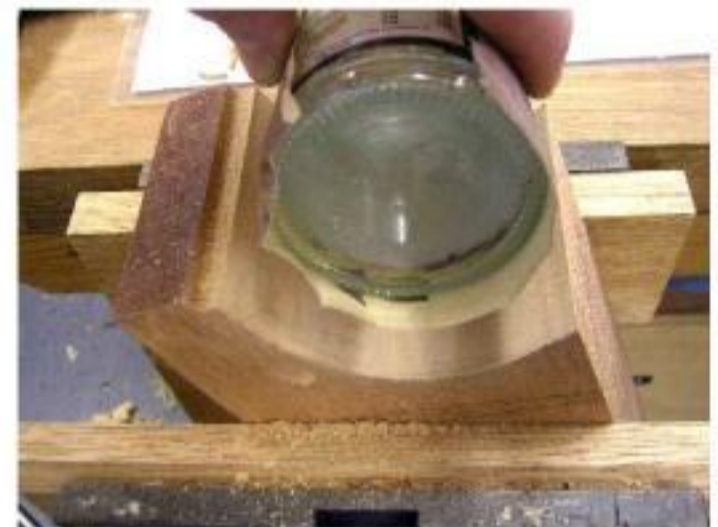
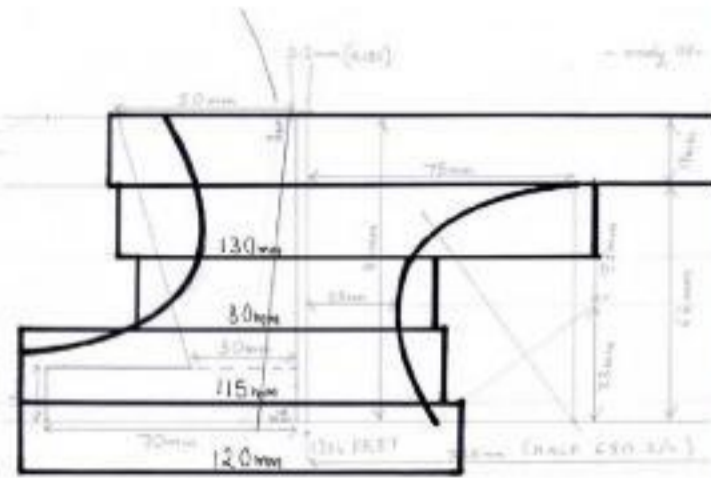

After smoothing off the curve I then began to cut out the Rib Slots making sure the markings for cutting were at a right angle to the Bench Vice to make it easier to concentrate on the other angles involved in cutting the slots.



While cutting with the Tenon Saw I had to remember to keep an eye on the top and bottom face to make sure I did not go outwith my guide lines and also I had to make sure I remembered that the whole cut tapered and so there was less deep a cut to make on the side at the the top half and more to cut down to on the side at the bottom face.



After all four cuts were made I used a quarter-inch chisel to carefully clean out the slots most of the way and then a fine 2mm chisel to clean them up fully.

## *Planing off excess wood on Heel and Tidying Rib Slots*



1: After cutting the rib slots, I thought it would be good to plane away the excess wood from the heel of the guitar to allow me better access to the slots for cleaning up.

2: I then planed the excess wood off actualk block using the 5 and a half plane initially then using the block plane again to tidy up finally. I also used a Wood Rasp to take some of the wood away at the neck to allow me to plane properly.

3: Heel with all excess wood planed off.



4: After cleaning this excess off, I was then able to tidy the slots a bit easier than before with the edge of a sharp chisel.

## Making Wedges to hold Ribs in position

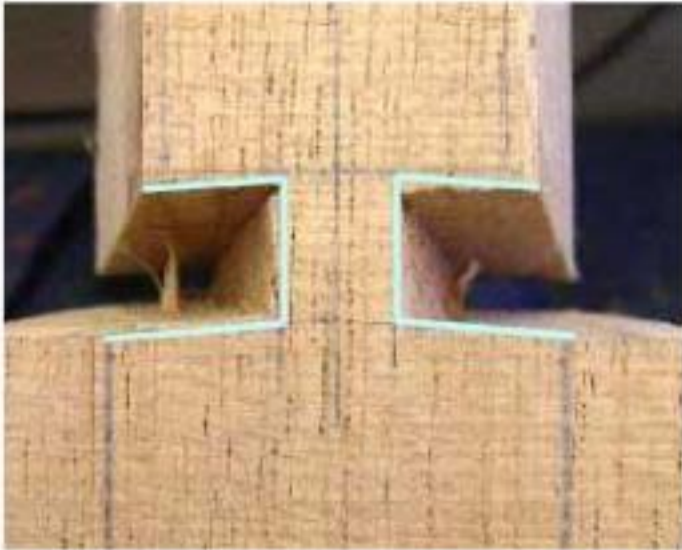

To make the wedges fit exactly, I had to take into account that the angles of the rib slots were not completely square as shown here on the left.

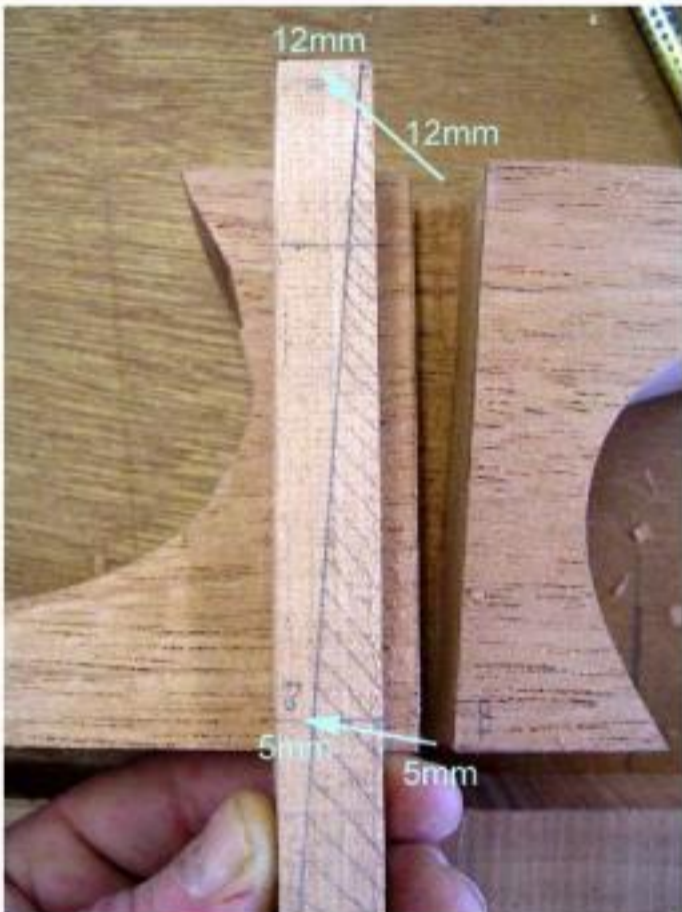

I then cut a small block of mahogany to a size a bit bigger than the wedge for the rib slot was to be. With the block held firmly in the vice, I used the block plane to chamfer off one full side but at a slight angle all the way along to try to match the same angle as the slots (see top picture again).

Once I had planed this angle I then marked up the wood

for the wedge by following the dimensions of the slot and drawing these on both sides, trying all the time to remember that the block when looked at from above would be beginning to take on the shape of a parallelogram.



Once I had drawn on the correct measurements, I was then able to plane down towards the line I had drawn all round the block as shown in the 2 photos on the right. At this stage I kept checking the wedge in the slot to check to see how close it was to fitting.

I then repeated the same process to make a second wedge for the opposite side which is the same except that it is a mirror image of the first.



## Making Sanding Wedges to clean up Rib Slots

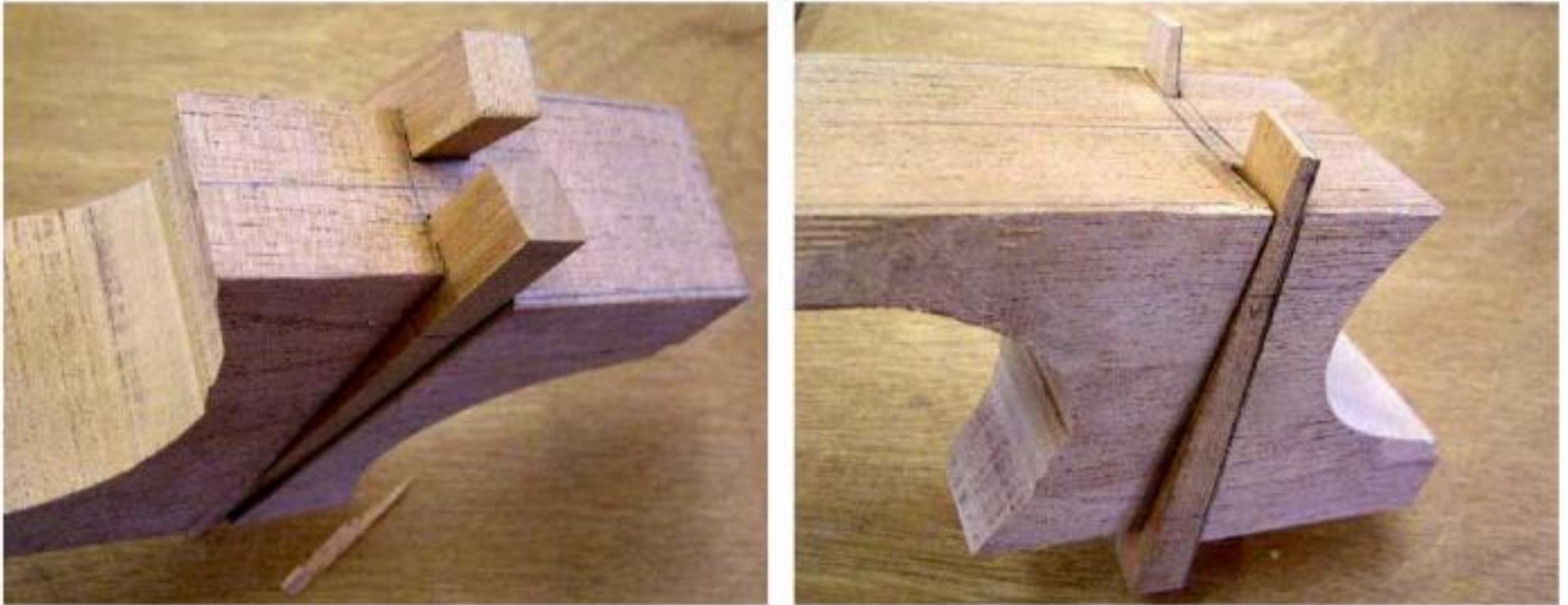

*I also tried to make sure that I remembered that the wedge is only to fill the gap that will be left after the 2.2mm thick rib has been put in place into the slot. Because of this, the wedge has to be made to extend a bit longer than the slot is at the moment, and this will allow the wedge to fully fill up the slot when eventually the rib is placed in position.*

*At this point I had the wedges fitting into the rib slots not too badly but after a bit of advice I made up some sanding sticks the shape of the slots by cutting out another set of 2 wedges.*

*The sanding sticks were made by using doublesided tape to fix sandpaper onto all sides of the wedges. These really helped clean the slots more finely than I was able to with the chisel and also I was able to get the wedges fitting much more tightly into the slots.*



## *Chiselling Heel Cap Shape*



## Carving Guitar Neck Heel Shape



*Initially I had to start carving away the side of the Heel and bring this face down to a slight curve as it moved down towards the tip. I used a small template here with a curve cut out of it and this was placed into the rib slot to keep a check on the curve and also to allow me to copy the same curve onto the opposite side. After getting this curve I then began to shape the heel using Gouge Chisels to curve my way around and gradually find the form.*



*After getting the shape of the heel roughly right I then began using the luthiers knives to refine the shape.*



## Refining Guitar Neck Heel Shape



*This is a selection of the tools I was using while shaping the heel. Files, Sanding Sticks, Gouge Chisels, Bevel Edge Chisels, Luthiers Knives, Scalpel, Cabinet Scraper.*



*With the shape roughly correct I decided that the downward curve towards the tip still seemed a bit chunky looking so I made the curve go in a bit more sharply to try to make the whole thing appear less clumsy.*



*Once the heel was nearly there I was then able to cut away the remaining edges of the neck inbetween the headstock and the heel using the coping saw.*



*I then planed this area smooth using the block plane to bring this area into line with the rest of the neck from the nut to the body join.*

## *Making a Straight Edge for Checking Flatness of Guitar Neck*



*Before going on to shape the back of the neck I had to first make a straight edge from a length of Beech wood for checking the area between the heel as it curves onto the back of the neck and the headstock. This is because a normal straight edge ruler won't fit in this area.*

*First I planed the whole piece of wood and made sure that it was square from the first face and then planed and squared the 2 sides. Finally I squared off the last face.*



*After this I drew on a diagonal on both ends to mark out where I would cut away a chamfer to give myself a straight edge like narrow strip which would be the edge I would use to check if the neck was running straight. Chamfering away this area took some time as it was awkward to fix the piece of wood down in such a way as to get the plane to shave at an angle.*

*Gradually I managed to get the chamfer down to the right depth and I was then able to finish the final edge off making sure it was as straight an edge as possible.*



*Checking the back of the neck with the newly made straight edge.*

## Finishing off Carving Neck

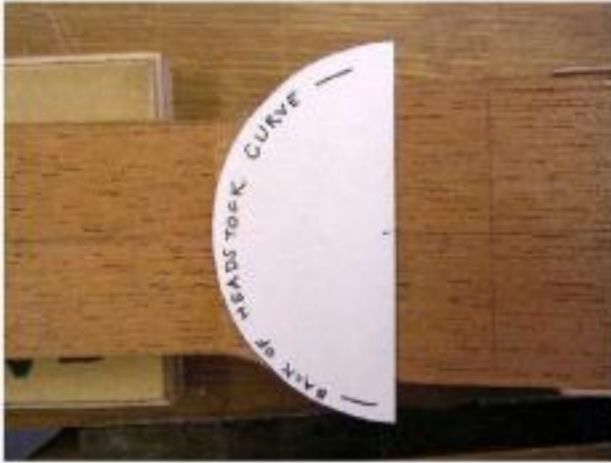

*At this point I drew out a half circle template to match the curve that was to be made at the back of the headstock where it blends into the neck itself. I drew this curve on with pencil and made sure I didn't carve into the headstock beyond this point.*

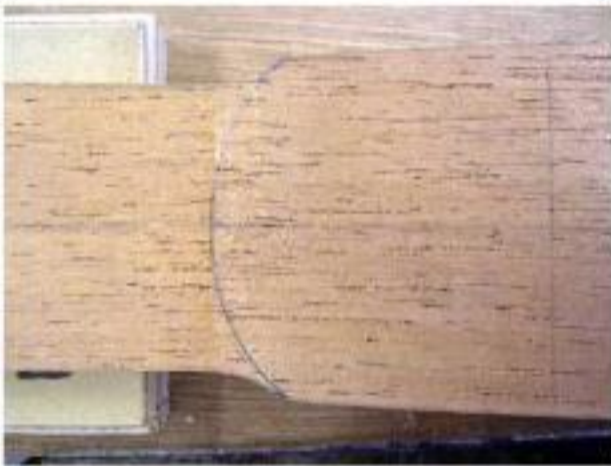

*Curved line drawn on headstock / neck.*



*Also I used the same circle template to draw on the side edge where the headstock top edge at the nut comes down towards meeting the curve drawn on the back of the headstock.*



*After this I was then able to start carving away this area trying to blend the headstock markings into the sideways 'D' shape curve of the neck.*

## Finishing off Carving Neck



At this stage the neck was clamped face down to the bench just at around where the heel and rib slots are. The rest of the neck was left free from the bench to allow me to get access with the spokeshave.



Once on to this area of the neck I had to try to reduce the thickness of this area just at the headstock end to just 16 mm thick. To do this I kept checking with the Vernier Caliper inbetween taking light shavings off with the bevel edge chisel.



Gradually I managed to thin this area to the 16 mm needed and was then able to continue with rounding the back of the neck from the heel end down to the headstock end.



Here I used the Spokeshave and tried both the wooden spokeshave and the metal one. I found the metal one was a bit more safe to use maybe due to the hardness of the body of it as well as the certaintiness that the blade wasn't going to alter depths while using. The wooden spokeshave seemed okay but it seemed that it might have cut more than wanted a couple of times so I just stayed using the metal spokeshave mostly.



All along while using the spoke shave I kept checking for straightness using the straight edge not only along the middle of the neck but also all over and right to the side edge of the D shape.

After working away at the neck I feel I have got it close to how it will be but I feel maybe the heel needs to be just slightly narrower more like a Torres Heel and also I need to make sure the neck itself has been equally shaped on both sides.



## Finishing off Heel and rest of Neck



I really felt as though I had not spent enough time getting the shape of the heel just right so I spent another day or two just trying to get it looking a bit more refined.

I used a nice sharp 5/8 inch shallow curve gouge to fine tune the shape and pull it in to a narrower overall shape much like some of the heels on guitars by Torres.



While carving I tried to check the shape from all angles to look for any bumpy areas. I also made a new template for putting into the rib slots for checking the way the heel curves down from the fingerboard.

On the second day of refining the shape I brought the area where the neck begins curving away and into the heel, a bit closer to the heel itself to make the curve when viewed from the side look a bit more natural.



The heel is now quite thin but I think it looks much better like this and is also less likely to get in the way of the players hand when playing at the 12th fret onwards.



On the 2nd day I also went back over the main part of the neck with the sanding block and tried to curve it more towards its finished state and also to make sure that it was straight from the heel end down to the thinner nut end.





## *Assembling Guitar Parts*

## Making the Heel Block



With the neck, soundboard, back and sides complete, I was now able to make the end block in preparation for gluing onto the soundboard along with the neck.

This process was much as before when planing a block of wood. I had to clean up one face with the block plane and get it completely flat. I then planed the sides flat in relation to the first face and in relation to each other.

Once this was complete I put the block onto the end of the soundboard and worked out how much material I had to plane off to shape it to the curve of the soundboard end.



I did this by very carefully planing the block in the vice on either side of the centre line I drew.

Once I had the curve matching I lightly sanded it to take away any flat angular areas.



Once I had done this I used the Try Square to make sure that it was completely at a right angle with the soundboard. I had to then adjust the face to be glued down by planing the block with a slight sloping of about 1mm to compensate for slight curving of the soundboard by the braces.

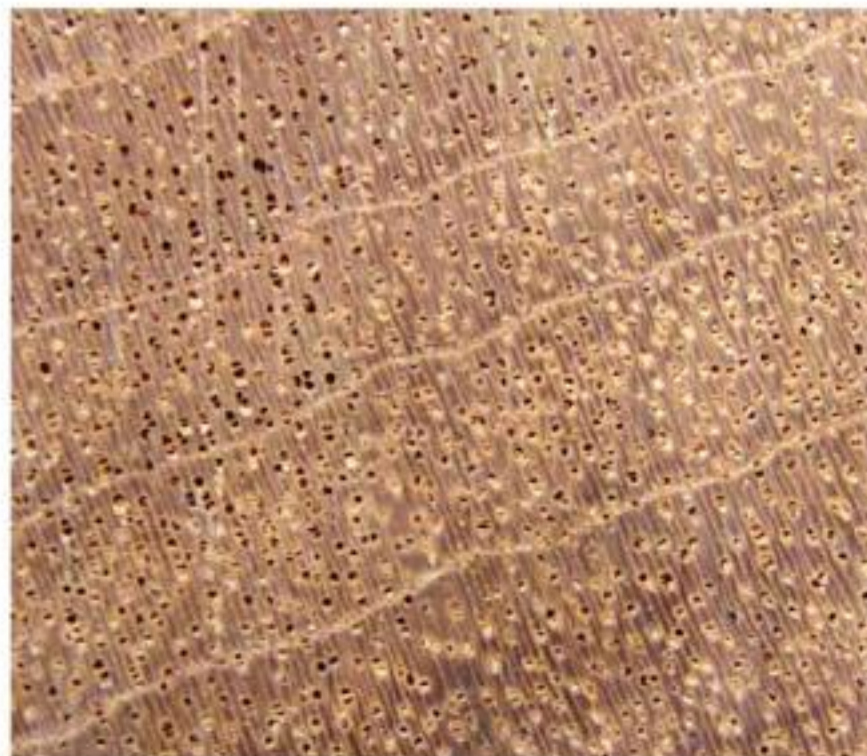

The sizes of the End Block is 95 x 70 x 15mm at the narrow end of the curved face.

This is a close up of the Grain of the End Block.

## Preparing Neck for Gluing to Soundboard



To prepare the neck for gluing to the sides, I had to chisel off some of the material that comes after the 325mm neck to body join length allowing the soundboard to sit flush on the top of the guitar heel block.



In doing this I had to make sure I had the guitar soundboard completely centre aligned on the solera workboard and also make sure that the neck itself was completely square in line with the soundboard.



Initially I measured the depth of the soundboard at the point of contact with the Vernier Caliper to see what depth of material I needed to remove. This was about 2.1mm. I removed the amount close to the neck / body join first and slowly worked the far edge down until it began to feel like the neck was beginning to sit flush with the both the soundboard and the especially angled neck extension of the solera.

Once at this stage I chalked the area of the soundboard and solera onto which the neck rests and checked to make sure that the two surfaces were completely meeting.

After this was complete I turned the soundboard over and propped it up and

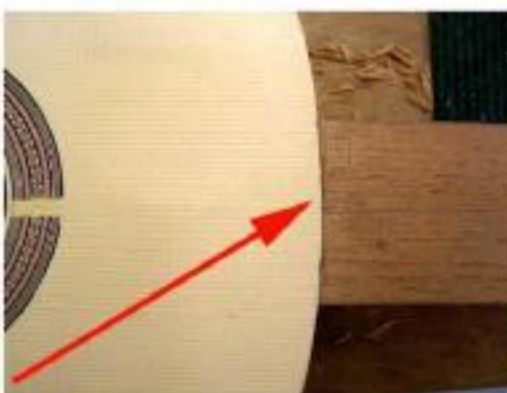
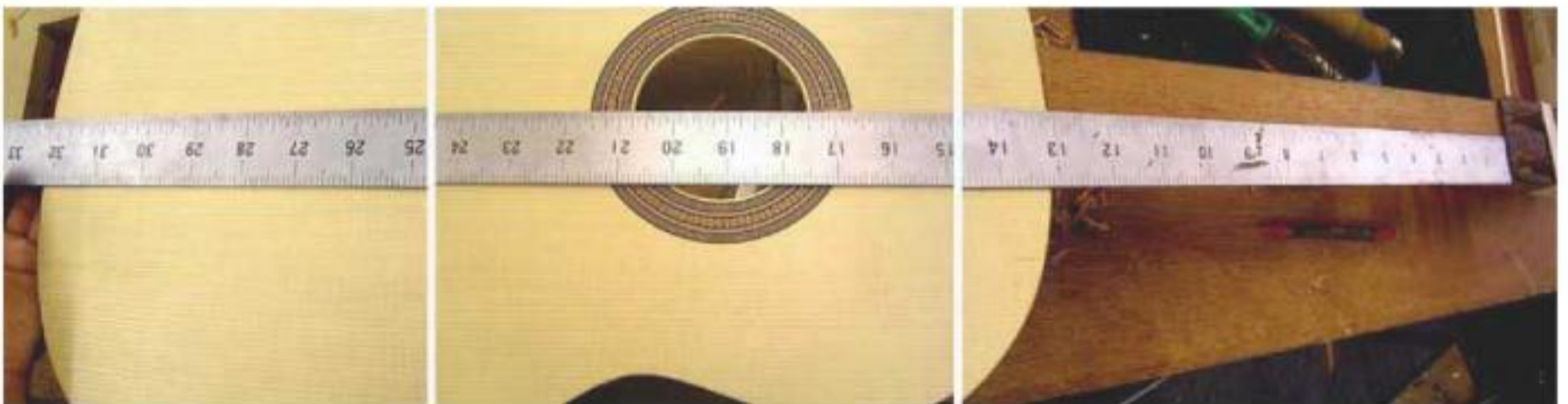

used a straight edge to check that the neck and soundboard were in total alignment. At this stage I had to correct the edge of the soundboard a little bit with a scalpel to make sure that the point where the neck and the soundboard meet was exact enough to not throw the neck out of alignment when gluing.

## Attaching End Block and Neck to Soundboard



To make sure the neck stayed in the centre on the extended area of the solera I drew a centre line down the entire solera and marked 2 lines leaving an equal amount on either side of the neck right at the end of the extended area.

I also marked the direct centre of the soundboard on with pencil and used these marks to line up the soundboard completely square with the centre line on the solera. I then used the soundboard clamp I made to hold the soundboard firmly in position. Next I marked in pencil the target area where the heel would be glued and made sure I had a centre marking on the end of the heel to keep everything in line.



At this stage I planed off some of the excess with the block plane from the bottom edge of the heel by clamping face down on the bench, leaving about 3-5mm extra for shaping when the back is eventually attached. With the heel and neck now ready to glue, I set the soundboard and solera in the Go Bar Press and tested everything out to make sure it would work and then went ahead and glued them both on. I also fixed the neck down with a cam clamp to the solera extended area to make sure it stayed in line with everything.



## Planing and Cutting the Guitar Kerfed Linings



The linings were made from either Willow or Lime.

Firstly I planed the 4 linings with the 5 1/2 plane on all sides just to clean them up.



After this I tried a couple of different ways to clamp each length of lining onto the edge of the bench in order to allow me to plane a curve all along the edge of each length.

After a couple of failed attempts someone told me I should use double sided tape and just stick them down to the edge of bench. This worked great and I managed no bother after this.



Next I had to cut the kerfs into the linings on the small bandsaw.

To do this I had to make a cut of about 20 mm into a block of mdf about 200 x 100mm. This was clamped onto the bandsaw table with the cut made in the mdf at the rear of the blade to act as a stop when pushing the linings in to be cut. After some adjustments I went on and made the cuts using a pencil line on the saw table as a guide for when to make the next cut.

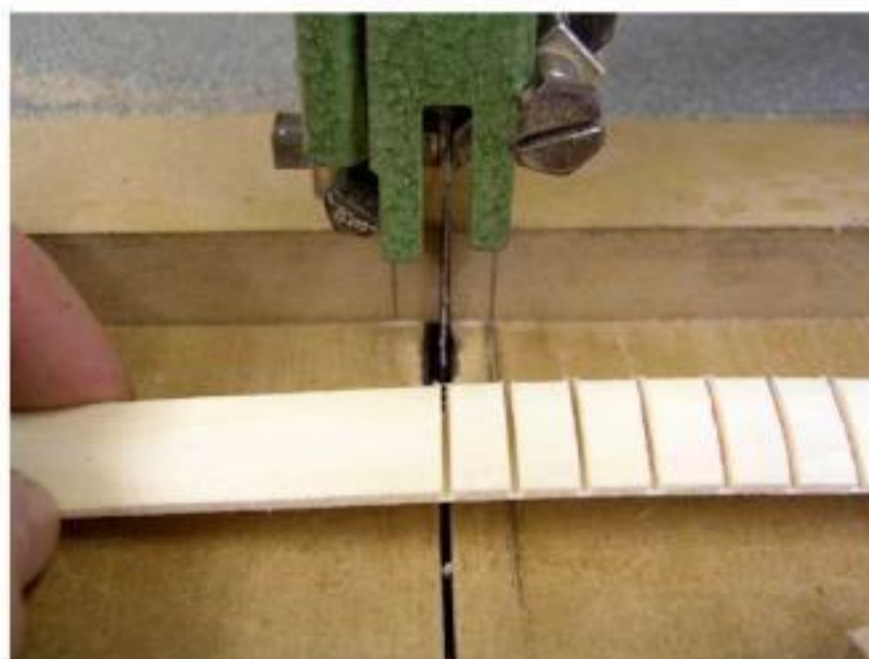

I did this with 2 of the linings then with the other 2 linings I made individual tantalous which I then cleaned up on a sheet of sandpaper.

## Preparing Ribs for attaching to Soundboard



With the neck and heel glued in place and the ribs now bent twice, I began to prepare for joining the ribs. Initially I had to mark on each rib the centre line at the heel and neck end according to the original soundboard tracing plan I used for bending the sides. Once marked on with the try square I cut off the excess material on the bandsaw and compared it with the actual soundboard.



With the centre line marked on the end block I was then able to align each rib with where it would fit into the slot at the heel and measure accordingly with the 6 inch rule from the centre of the heel to the edge of the rib. This gave me the marking for the edge closest to the fingerboard (around 16mm). For the edge closest the back of the guitar I only measured from the centre to the edge of the heel itself (about 6mm).



Once this was done I was able to mark the diagonal along the rib and cut away the excess material again on the band saw. I checked it for fit and using the block plane with the rib on the edge of the bench I carefully honed away a few times

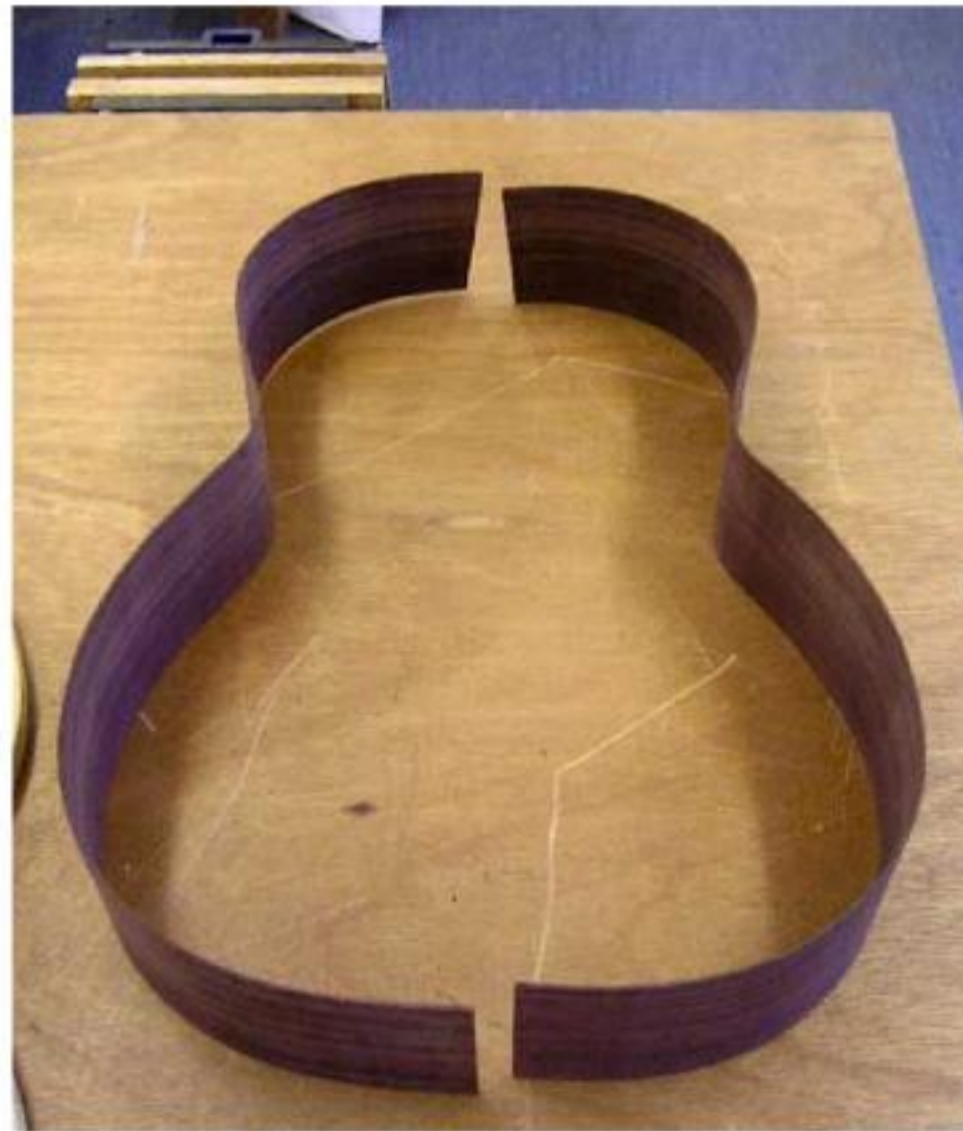

checking inbetween until the rib matched up as perfectly along the edge of the soundboard as possible. I also had to check that the rib wedges were fitting exactly and adjusted the extra length I had made them so that they fitted all the way down.

With the second rib I had some problem getting it to fit and

lost a bit of material at the end block end. This is ok though as I know I will be adding an inlay of rosewood later on. The main problem seemed to be that the waist curve was now a bit further towards the upper bout than needed so I had to shift that curve by bending the rib again. The 3rd time for this rib seemed more difficult but with a fair bit of help from Bill we managed to get it fitting quite well.

## Setting up Go Bar Press for Gluing Ribs

With the ribs now as close to the shape as possible, I set them up on the solera on the Go Bar Press with two pieces of pine stretched over the top and Go Barred down to try to keep the ribs completely vertical. I made sure the sides were square by using the try square all along the lengths of both ribs.

To clamp the endblock I had to use two clamping cauls a bit longer than the block itself (about an inch either end) so that I could put the clamps onto the area after the block to give more clamping pressure in bringing the ribs completely flush with the curved edge of the end block.

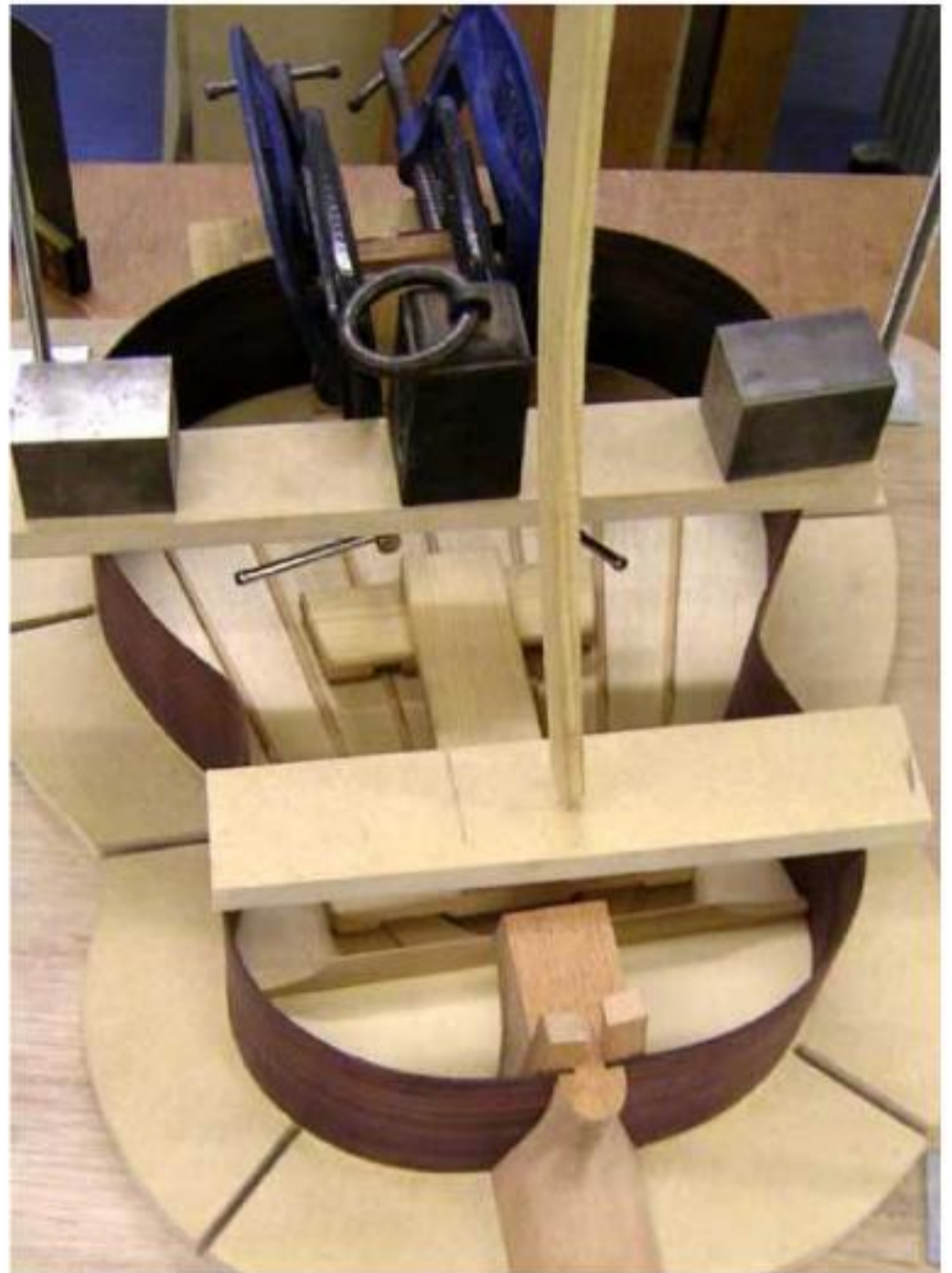

Also here I had to check that this clamping was not pulling the ribs out of alignment.

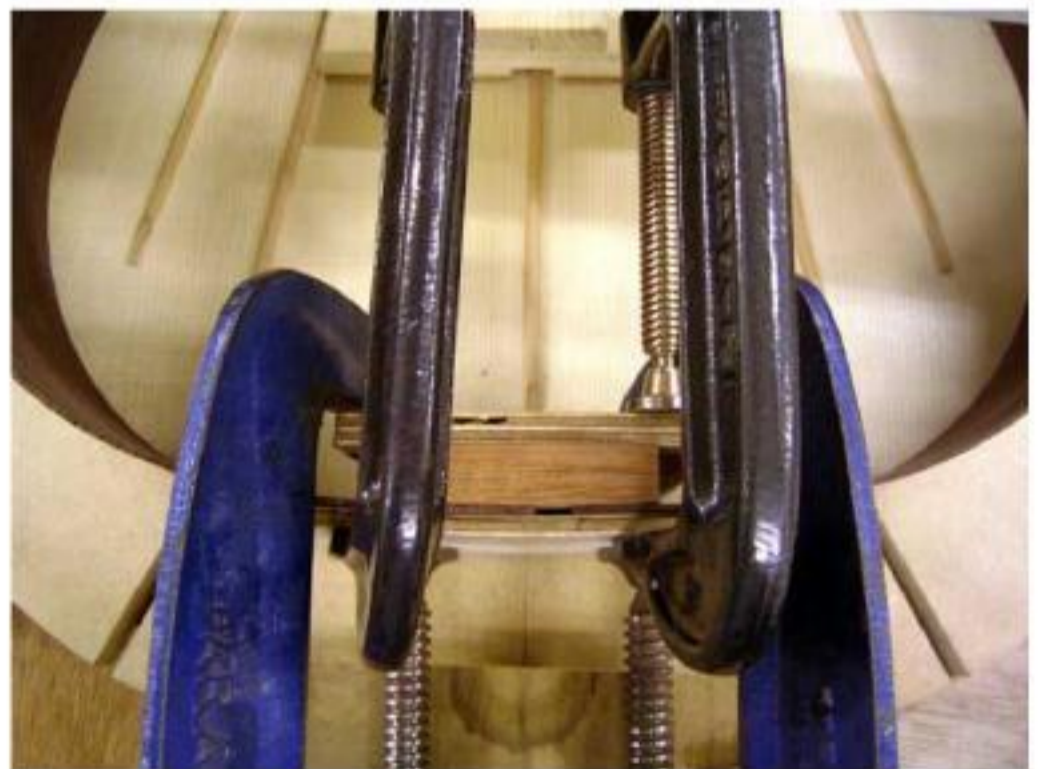

## Gluing Ribs at Heel and End Block



With everything prepared and checked I heated up the animal glue and prepared my rib wedges for gluing and had a cloth on hand for wiping away any spillages. I also covered up a lot of the area with masking tape too for this purpose.



The first rib I done not too badly though I was surprised at how quick the animal glue sets and unfortunately I glued this first one in place leaving a little gap along the edge coming from the heel of about 1 maybe 2mm between the soundboard and the rib. This I thought was bad but Paul said was fine as this area will be cut away for binding. The second rib went much better and I think the glue was hotter for attaching this rib as it didn't seem to grip as fast.

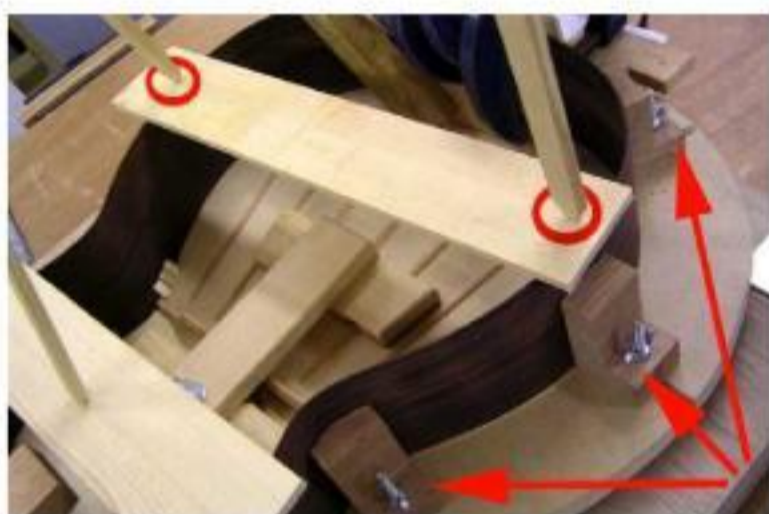

Before going on to glue the end block, I then finished off the solera L shape blocks for helping keeping the ribs vertical. I curved the blocks for the waist and placed all 8 onto the solera and this I felt really helped keep control of the ribs when clamping the end block.



For the end block I checked with a practice run again using all available clamps making sure all the L shaped blocks were tight against the soundboard. Also with the pieces of pine stretched across the top on the Go Bar Press I was able to manouver the ribs into place quite well. With a length of marine ply I applied the Titebond glue to the end block and pushed the ribs back in place and began clamping the whole area. I had also soaped the side of the clamping caul which goes against the ribs to make sure it doesn't stick to them due to the squeezing out of the glue.

After this I cleaned up the excess glue as best as possible.



## Gluing on Tantalons

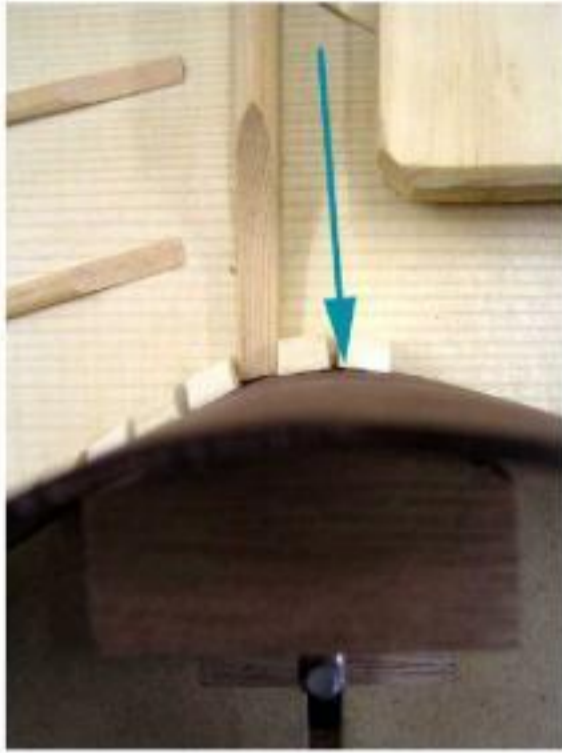

For Gluing on the tantalons again I had to use the hot animal glue. Using animal glue I think makes it easier in future if a guitar needs to be taken apart for repairs as the animal glue can be remelted using a heat gun.

Having already sanded all the tantalons square I began applying them with the animal glue which I kept on the boil close by to where I was working. After applying maybe 15 tantalons or so I discovered that I should have been shaping them individually according to where they were to be glued especially on the waist and the sharper curves along the upper and lower bout. After this I began to take more note of this and shaped them accordingly. Initially I glued the tantalons on the lower bout, making a larger tantalon from spare lining when I got along to either end of the end block.



When moving from the waist up toward the heel I did the same and made a larger tantalon at the upper harmonic bar and then a slightly sloping larger tantalon too when I reached the sloping heel end of the guitar.



I left a gap of about 1 and a half to 2 mm between each block. Not sure the



effect this will have but hopefully it will be strong enough to take the pressure of cutting out the purflings and linings when I get to that stage.

Finally I made 4 longer verical tantalons from douglas fir to sit on either end of the harmonic bars and support the ribs. With these I made a slight mistake in not making sure they were completely square on the rib. 3 out of 4 are ok but one I think is slightly off but not too badly. Next time I would mark on a vertical line square with the soundboard to make sure. Also next time I may make these extend the full length of the rib and make the back brace positions match the soundboard brace positions.



*Block Planing down Ribs for Back Fitting*



## Marking Ribs with chalk and Planing

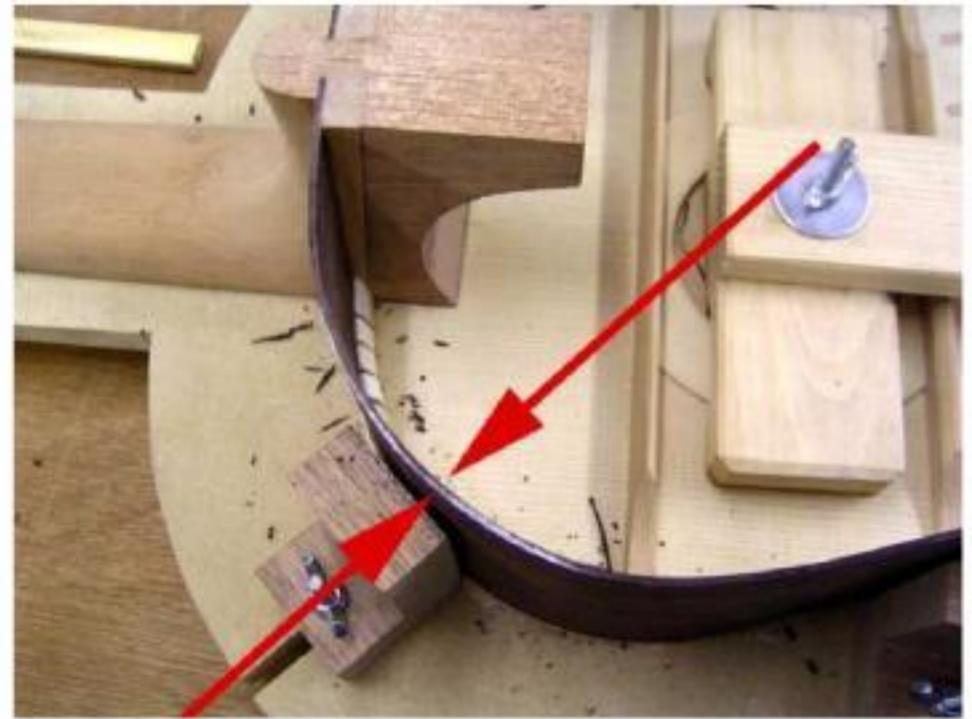

With the tantalous in place I began the job of fitting the guitar back to the ribs. This involved applying chalk to the Back Solera and positioning it on top of the ribs and rubbing very carefully around the area in order to apply chalk to the high surfaces.

When the Solera is taken off, the areas which need planed are highlighted and then planed off using the block plane trying to follow the direction of the curves of the rib. This process is repeated until gradually all areas become chalked showing that the shape of the solera is finally meeting the entire surface onto which the curved guitar back will be glued.

It is also very important to keep track using the Vernier Caliper that the height of both ribs are remaining the same as each other as it could be quite easy to end up with a slight sloping off on either side making one rib bigger than the other.

Also important is to be careful when planing the end block and especially the heel block with the end grain of the rib wedges. With this area I made the mistake of not planing into the centre of the heel and split a little of the edge of one of the wedges so after this I made sure to plane from the edge inwards to avoid this.

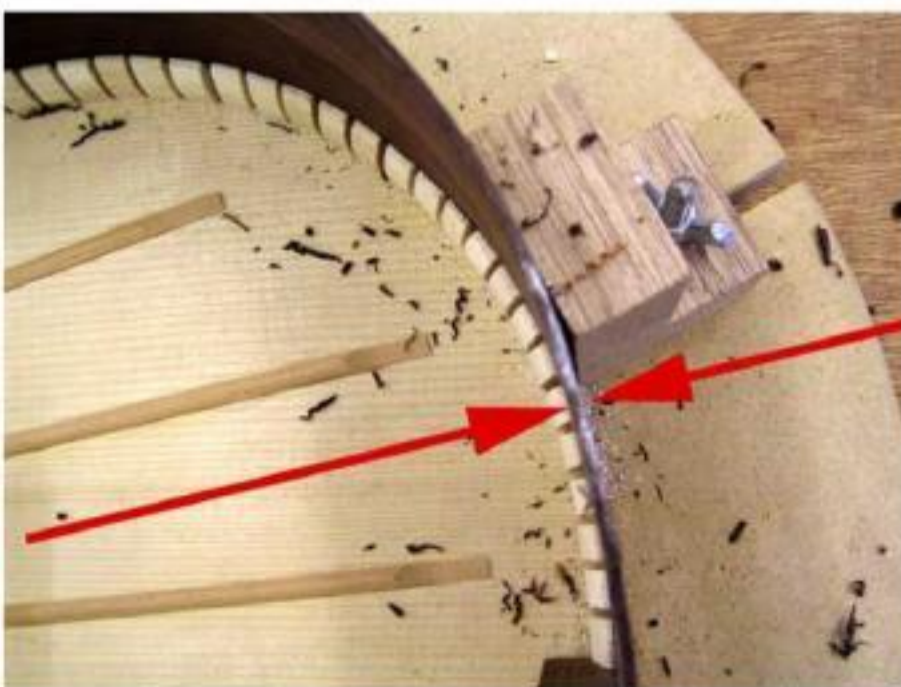

## Day Two of Planing Ribs to get Back Fitting

On the second day of planing the ribs I gradually got closer to getting all the areas showing up highlighted in chalk which suggested that the back would fit perfectly however by checking with the vernier calipers I discovered one rib was higher than the other on the lower bout end so I had to plane back that area to match up with the oppsite side.

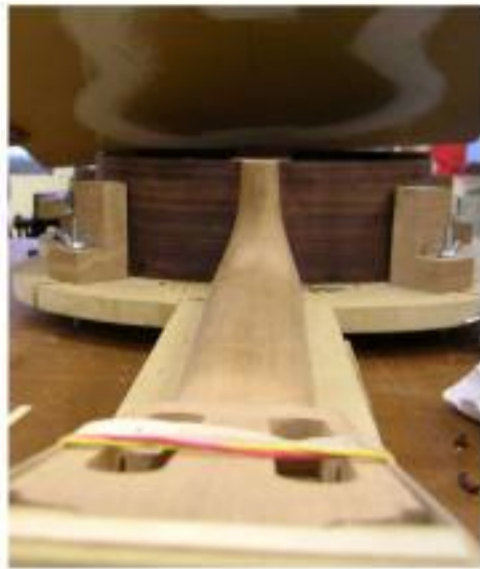

The planing of the heel block was quite difficult as mentioned on the previous page and although it was suggested I could add a piece of wood to bring the height up to the level needed to fit the back, I decided to just keep bringing down the heel itself as I had plenty extra left over.



The heel took at least half a day to get right but in the end I got there and was now ready for the next stage of preparing the back for joining.

I trimmed off the extra 2mm or so on the back braces (to account for the width of the ribs) using the veneer saw and then used the chisel to remove the brace ends. Once this was done I was able to test the back for fitting and after a few more attempts with both the back solera and the actual guitar back, I finally reached the stage where I could move onto attaching the kerfed linings which will hold the back in place.



A lesson I learned here was that it's important to keep track that the difference between the height of the ribs at the heel and the end block remains the same as the plan. I felt here I was gradually making the guitar all the same width from end to end. I think I fixed this though by noticing early enough.

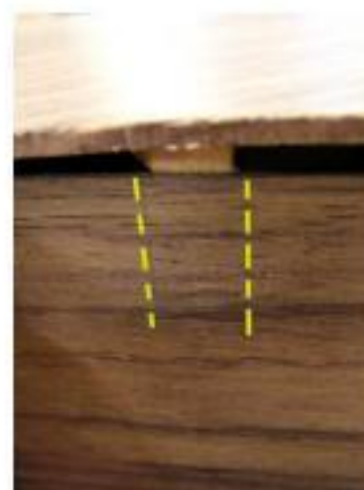

## Gluing on Linings for Attaching Guitar Back

With the guitar back fitting, I began to attach the kerfed linings which I cleaned up a little with a sanding stick.

Initially I done a test run to check fitting and also some of the kerfing split so I had to make sure it was going to stretch exactly from one end to the other. At the slipper heel block I had to angle the kerfing to



account for the sloping of this part. At the End Block end I had to add in a couple of pieces to span the final few inches so that it glued firmly onto the block itself.

Also important was to attach the kerfing about 1mm proud of the rib to allow later planing at a slant towards the shape of the curved guitar back.

Once I had tested both sides using the clothes pegs and the small steel clips I took off one side of Kerfing and laid it out in the order to go on



and had the small mirror nearby to make sure I checked for any gaps or glue squeeze out while gluing.

I put on an even layer of glue spreading it to the same level all along each length of kerfing and wiped the glue from the underneath edge using the mirror as mentioned to see under the pegs which obscured everything a bit. For a couple of sections I had to use a much bigger clip and a wedge of wood to force the kerfing firmly down where it was not naturally sitting in place. Thankfully I noticed these in time.

I left one side to glue then repeated for the other side at least an hour and a half later once the glue had dried completely.



## Planing Linings and Chiselling Brace Slots for fitting Back to Body



With the lining glued on both sides I then began to plane it down towards the rib height but trying to use the block plane at an angle to make sure I left enough material to take the curve of the guitar back.

After this I continued to use the chalked back solera to assess what areas of the kerfed linings need to be planed, trying to achieve again a fully chalked surface all round including the heel and end block.



Once I was near to getting the back solera matching, I applied the actual guitar back and marked on as exactly as I could the places which need to be chiseled out to allow the back braces to slot in place into the kerfed lining.



I went around carefully marking with pencil and then using a steel rule I drew on the markings directly across from one rib to the next to try to keep everything in line.

Using the Vernier Caliper to measure the height of each end of the back braces I then marked on the depth each individual slot had to be. After this I used a Razor Gent Saw to cut down into each slot according to my marking not going past the depth mark and not cutting into the actual rib.



With these saw cuts made I chiseled out each slot very carefully, trying not to unsettle too much of the wood around. Inevitably there was some break out where the saw cuts were too close to the original kerf cuts but in the end I made not too bad a job of it.



I tested the back onto the guitar and some of the brace slots were not quite deep enough so there was a bit of fine tuning here to get everything fitting flush.

After this I still had to do a bit more with the chalked back solera to try to get that fitting correct.

## Two Test Runs before Gluing



With the guitar as close as possible to fitting and after a couple more adjustments as regards brace heights where they fit into the linings, I went on to attach the back to the guitar using some spool clamps to test for any hollow sounding areas around the heel and end block area which would indicate that there was a gap somewhere. By tapping quite firmly around these areas the difference in sound between the block and the rest of the surrounding back area is quite obviously different. Also an important check here too was visually looking into the soundhole to try to assess whether the linings were sitting firmly onto the guitar back with no gaps. Thankfully it seemed to be fitting fine and I had no more need to plane the linings on the ribs.



Because the guitar back was slightly larger (allowing for mistakes) I now had to draw

around it while it was all clamped up using the rib edge as a stencil to mark the exact shape I needed to trim the guitar back to. Getting it exact would also help as the spool clamps need to be tight in close to the work to grip it firmly.

Once I had this line drawn on I clamped the back down to the bench with 2 clamps and used the block plane to hone the edges back to the line. For the waist areas I had to use a chisel as I couldn't get into these areas with the block plane. With this done I clamped the work up again using just a few spool clamps to test it once more for fit and also at this stage I checked the neck angle using the special neck angle stick which I had made (see below). The neck angle seemed to be close though was going to be needing to be pushed back about 1mm during the initial steps of the gluing process. At this stage I prepared for gluing up.

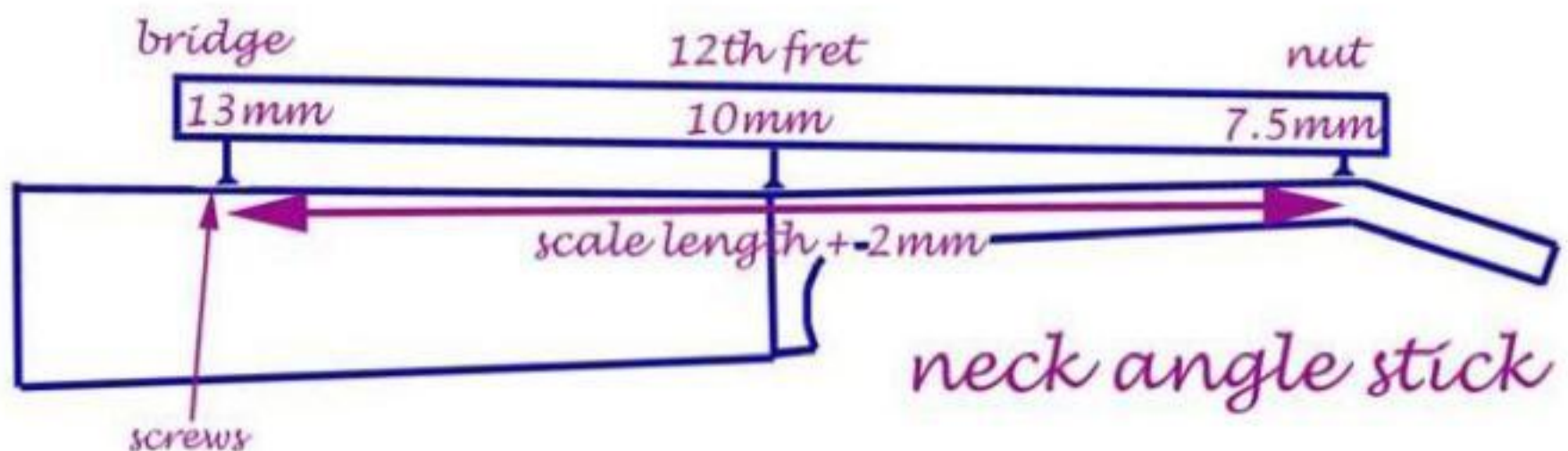

## Gluing the Guitar Back with the Spool Clamps



With all the spool clamps set up around the work and 4 G clamps ready for the end and heel blocks, I was now ready to glue the back in place. As I would now no longer be able to access the inside of the guitar, I cleaned up the soundboard and around the ribs and linings with some fine grade sandpaper. Also at this stage I signed the soundboard and dated it. After this I applied glue along the edge of the linings to be glued and also into the slots for the back braces as well as the heel and end blocks - this took maybe 5 minutes in itself making sure that it was evenly spread to minimise any possible squeeze out on the inside of the guitar. I also had 2 long sticks prepared for reaching inside in case of this situation.



With the glue applied I put the back in place and turned over back facing down onto a large block of wood which I had set up to hold the guitar higher above the desk while applying the spool clamps. With the first spool clamps in place lightly at the heel and end block end I checked the neck angle and it seemed to be sitting right so I then put on a few more spool clamps at sides to bring all the glued surfaces together quickly. I then put on the 4 G clamps,

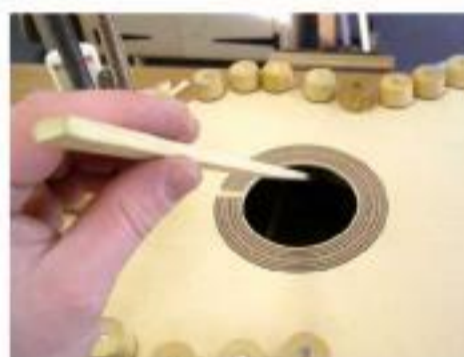

2 at either end on the blocks using pre-shaped clamping cauls to match the sizes of the blocks. Again I checked neck angle and it seemed to be still ok so after this I just filled up all sides with as many spool clamps as I could until I was happy all sides were clamped fully. After this I had to use the 2 sticks to clean up any squeeze out of glue and handy here was a small torch to see inside the guitar. Once content the inside was cleaned I then cleaned around the outside gluing edges while adding in more spool clamps to make sure the whole back was firmly in place. After this there was a little more glue squeeze out so did a bit more cleaning on the inside and then it was ready to be left to dry. I also was then able to get rid of the initial large block I propped the whole guitar up with as the guitar was now resting securely on the spool clamps.





## *Cleaning Up after Gluing*



*After letting the glue dry fully over a couple of days, I removed all the spool clamps and began to tidy up the soundboard and back edges which were still overlapping the ribs slightly.*

*Initially I had to remove most of the excess wood using a sharp chisel, and after this I was then able to tidy up the surfaces of the ribs using the cabinet scraper.*



*This helped remove any flat areas formed during the process of bending the ribs.*



*I also used the scraper on the back and the soundboard to clean off some of the marks left by the spool clamps.*

*One possibility missed at this stage would have been to completely finely scrape and sand down the soundboard and apply one even coat of french polish to prevent any further damage, especially when cutting and gluing the purflings / bindings etc. The next time I would do this as the soundboard is quite easily damaged.*

## *Chiselling Binding Channels*



## Inlaying End Block Detail

With the Guitar Body cleaned up it was now time to prepare for inlaying the patch of veneer on the end block of the guitar.

The patch on my guitar would be a bit wider than normal as I had made a mistake and cut off too much of one rib when attaching it to the heel.

First of all I found my centre line by cross referencing the centre joins on the soundboard and back and then using the sliding bevel to double check these measurements. Once marked on I worked out that the patch would have to be 32.5mm + wide so I used this as my size.

I began by scalpeling these 2 lines then began to chisel out the excess rosewood very carefully chiselling away from my body to avoid injuring myself.

With the guitar neck built onto the classical, it is quite awkward to work with. I made sure that I didn't chisel towards my fingers and also I didn't go over the edges of the soundboard or back to avoid splitting the wood.

Once most of the material was removed I used the violin knives to more carefully cut away nearer to the edges and then finally I trimmed the fragile edges with a scalpel.

A big mistake I made here was in cutting this area first as I should have made the patch up first and then cut the shape to match it.

With the area now cut I had to very exactly draw up a plan to work out how big the central piece of rosewood would be. I did this by measuring the sizes of the bindings and the 4 lines of purfling and calculated sizes from there. Once the patch was half way made I tested out the width of it by fitting it to the area. It was a good match and only slightly too wide at one end which I could easily fix by flat filing the end block area a little. I then finished off the top and bottom of the purfling on the patch.



## Gluing in End Block Detail and Tidying Up



When I went to try the patch on the guitar I then found out that I should have made the patch a little bit (2mm) longer because I needed to allow the binding to be glued on with about 1mm standing proud either end to allow for mistakes with Chiselling the binding ledge etc.

After a bit of help I was told if I trimmed off the binding edges off the patch and add new pieces which were just a bit longer then this would add just enough height to make the top and bottom bindings meet up with the patch. I cut then planed away the old binding edges from the patch then re-glued the new longer pieces in place.

The drawing on this page is the new version with adjusted sides. By following this advice I then filed back the rib edges on the end block area as mentioned earlier in order to fit the patch in place.

Once in place I used hot animal glue to glue in the patch and used string looped several times around the sides of the guitar with a block of pine on top of the patch. I then put a pencil in amongst the lengths of string and began twisting in order to tighten the block against the patch. I'm not sure I was quick enough here as I felt the patch didn't go in as well as I would have liked. I think the next time I would just press the patch in place with my hands to make sure it is fully flush with the ribs then tighten up the string and block once I know it is in place.

Once patch was dry I scraped and sanded till all inlays were completely flat.

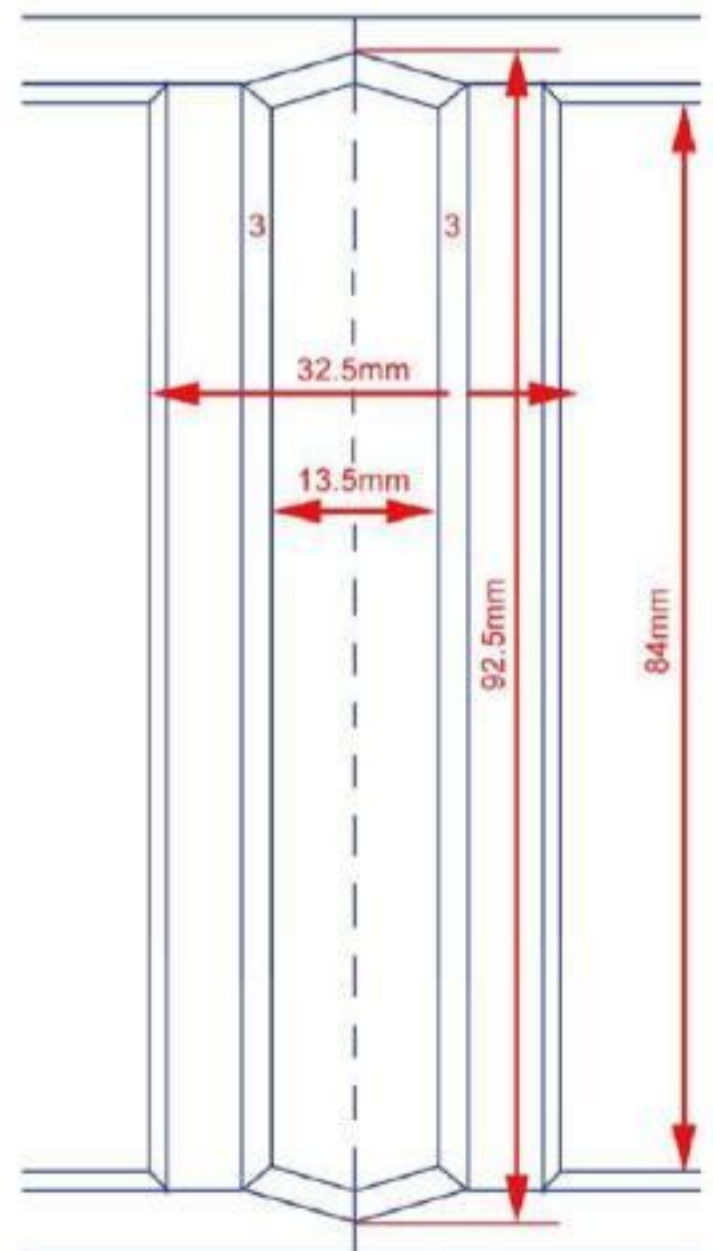

## Cutting Purfling Ledge



With the End Block Patch in place on the Ribs, I was now onto the purfling stage. To begin with I tested out some variations to see what would match the rest of the guitar and decided to use red, white, black, white, the same as the end block patch with the red next to the soundboard.



To begin I set the purfling cutter blade to just a bit less than the width of the combined 4 ply purfling and the rosewood binding. The reason it's a bit less is to try to make sure there is just a little extra left over of the binding in case again of over-Chiselling when cutting the ledge.



After this I began lightly scoring into the soundboard keeping the long brass edge of the cutter completely vertical and in line with the rib as much as possible. Also here I had to make sure I was cutting in the correct direction of the grain. Drawing on left shows start points as red dots for cutting and planing soundboard / back.

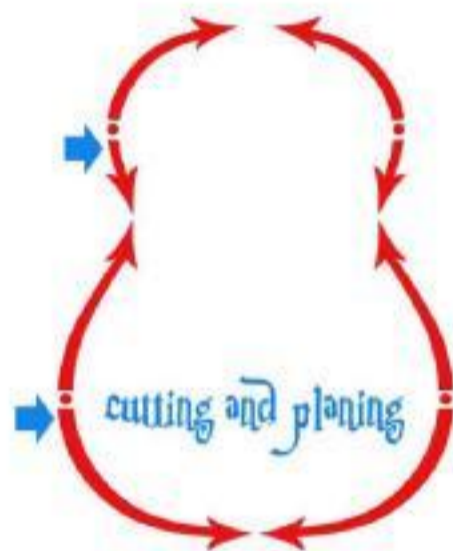

A mistake I think I made here was not to coat the edges in some animal glue before starting to cut into the soundboard. This would have helped stop any tearing out of the wood which did happen even although I was very careful throughout.



After a light scoring, I then went over each line a bit more with the cutter until I had cut to no more than 2 1/2mm. After this I used the chisel to gently cut down the level of the soundboard on this edge leaving about 1mm left all round. There was some areas in the upper bout where the ledge broke out completely but this should be covered



by binding eventually. In between using the chisel I also had to scalpel away a little where the wood grain was quite hard especially at the cross grain areas. A sharp scalpel blade was important here. With the areas where the grain broke a bit I put on some animal glue to hopefully repair any damage.

## Gluing Purfling Strips to the Guitar



With the ledge now cut into the soundboard I was able to begin the job of gluing in the four purfling strips of white, black, white and red beginning at the end block end. I glued it using the hot animal glue beginning by trimming the purfling at the centre join area of the end block with a chisel to neaten the ends.

After this it was a case of applying glue with the brush making sure to coat the ledge itself and then the sides of the veneer strips and pushing them into place and pinning using the map pins. After a while I realised it was good to use a damp cloth after applying the glue to take away the excess before pinning in place.



Sometimes the pins were hard to put in place but gradually it worked. It was a bit messy but the animal glue should clean off later.



Once the glue was dry I then took off all the pins and began to chisel away the purfling back down to the layer of the soundboard. I followed this with the cabinet scraper to get everything level which would be important for the next stage of cutting the side binding channel where the cutter would rest on the soundboard surface.



By beginning at the end block end it meant that a neater job was made as once the purfling reached the neck it wasn't as important to make a neat cut as this will be hidden by the fretboard eventually (photo on left).

## Cutting Ledge for Binding Strip



With the purfling trimmed back I then went on to use the cutter with the flat side facing the soundboard and the cutter cutting on the rib edge. To begin with I set the cutter to just slightly less than the width of the binding to allow the binding to be slightly higher than the edge to allow for any mistakes while cutting.

I cut along the rib at the set depth all the way around making sure to score lightly at first and then gradually go deeper. Once I done this I also decided to score the line for the back binding so that I will set it to the same depth when cutting that also.

Once all edges were scored I began to chisel away the soundboard binding channel. This

was quite difficult but I found that laying the guitar on the edge of the bench and working directly over it made the job a bit more consistent. For the curves back in towards the neck and end block, I leaned the guitar against a piece of carpet on the bench while seated. It went quite well though I did chip the edges about 3 or 4 times but hopefully this will not show once the bindings are glued and everything is scraped back.

At the end block inlay end I was very careful not to score too far along as this will be the area that needs most attentions as regards joining the bindings to meet with the inlay.

After the initial Chiselling down towards the edges of the purfling, I then scored a second deeper cut into the ribs to bring the chiselling a bit closer to the purfling edge. This went

well enough though at one of the waist points the purfling seems to have a deeper curve than the actual rib itself so hoping that the binding will fill this area without it going into the body past the rib edge otherwise I might have to thin the rib a bit more to make the two surfaces meet up.



## Cleaning and Squaring Up Binding Ledge



Once I had chiseled out most of the ledge for the binding I then went over it all very carefully using a flat file to try to make sure that the ledge was completely square with the rib. The rosewood binding is very tough material and any bumps would not be covered up even by forcing the binding onto the ledge.

I went along the whole ledge on both sides trying to make sure that the file was flattening right up to the very edge of the purfling which is the edge the binding will sit flush against.

Also here I had to chisel out the area where the binding meets the neck body join. At this point the binding has to actually be inserted in a bit further than the edge to allow for any possible changing of the shape of the heel curves once all the binding is glued on.



I took the binding in about 5mm although I perhaps should have taken it in by a bit more to about 15 to 20mm but hopefully this will be enough as I am pretty sure the heel curves are very close and should not need any more carving.

After this I went along the full length of the ledge with an offcut of binding to make sure that the binding was going to fit and continued to file any areas that seemed to be bumpy.

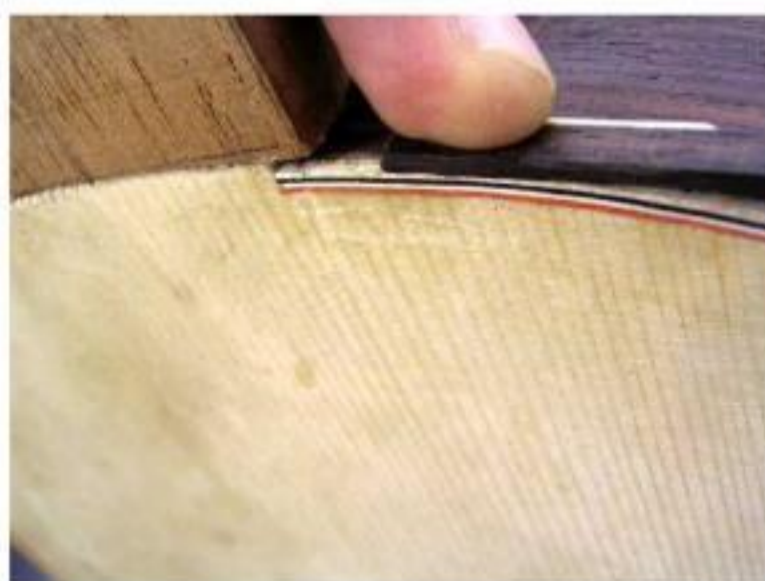



## Bending Rosewood Binding Strips

Once happy with the ledge for the binding I was then able to move on and begin bending the binding with the bending iron. This was more difficult than I thought and in the end I wasted 3 bindings.



This was mainly due I think to not having wet or steamed the wood. They bent quite fine apart from the sharp waist curve which was where I made the break each time.

To get the waist curve mid-point I measured along with a piece of paper. The waist was 255mm from the neck body join end. With using the cloth to wet the wood a little before bending I managed to get the waist curve a bit easier. Once the waist curve was done the rest was a bit easier as the curves were more subtle. Basically I kept comparing it to the ledge on the guitar and marking along the edge with a pencil where I thought the next bend should be and gradually managed to get the piece following the same curve as the guitar body.

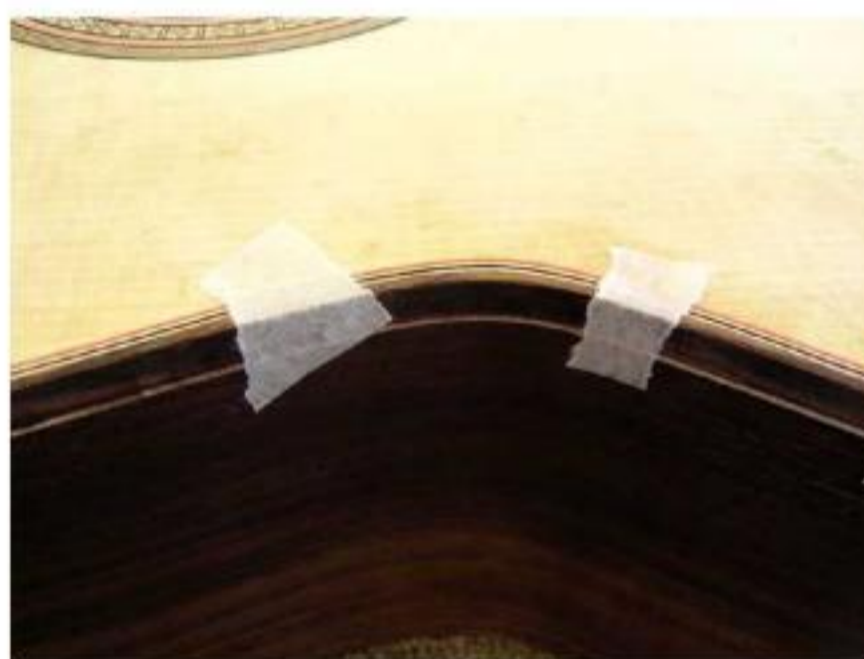

I then repeated this for the other edge of the soundboard.

Once both were bent I taped them onto the guitar with masking tape and then very carefully marked on where the two bindings would meet at the end block and cut them using a small saw initially. I left a little bit extra (1mm) just to make sure I'd have enough. To get the angle I held the bindings on and using a small ruler tried to draw the angle on in thin pencil and then chiseled this edge away.



At this point I then cut the 45° mitre cuts on the thin white section using a chisel and again fine tuned it all a little until all areas seemed to be fitting together. At the other end where the binding fits in at the neck body join, I had to slightly thin the binding to allow it to go into the body as I couldn't thin the heel or dig into the purfling.

## *Test Run, Scraping Ledge, Gluing Binding then Tying*



With the binding now cut to exact size and ready to fit I done a test run without glue using the string to fully bind the binding onto the guitar.

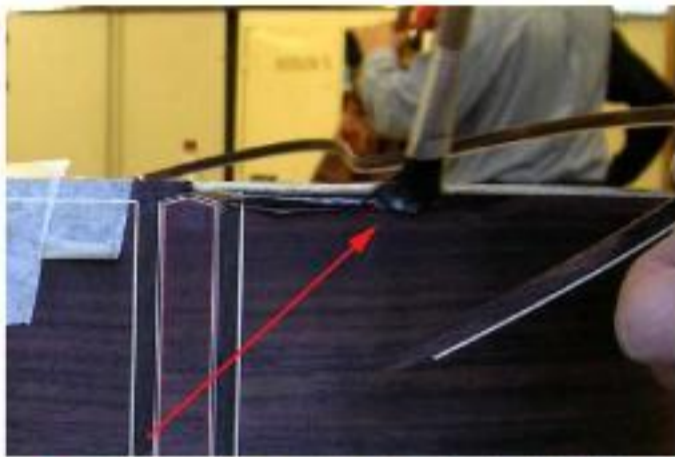

Binding was to start by going around the waist several times then moving from the waist towards the lower bout and continuing back and forth always trying to cross in the middle. The main aim is to have the guitar bound by the string at roughly 10mm intervals along the whole edge to evenly spread the force while the glue is drying. Aso by finding a pattern to placing the string it also saves on wasting string length with random tying.



With the test tun I discovered more bumps so I went along the whole ledge again by eye and tried to take out all lumps by running the sharp edge of the cabinet scraper along it. After this another test run and this time it looked good to glue.



With some new hot animal glue heated for about 20 mins in a pot of boiling water, lots of lengths of masking tape on edge of bench and with the heat gun close by I was ready to start. I applied the glue starting from the end block binding join and made sure not to glue in the opposite binding with too much glue here (this binding was left taped in place as it needs to be on the body to stop the string from damaging the purfling edge). After this I applied glue every 4 inches, pushed binding in place and masking taped over join, and repeated this all the way to the end. After this I then applied the string from the waist all round and gradually tried to cover the full length of the binding and exert plenty pressure on the glue join. Once bound up, I

then went back along the edge with the heat gun and applied heat to the animal glue join to re-melt some areas that were not good joins. Once heated, I then bound some more string specifically over those areas and then finally left this to dry overnight. Next day I repeated the whole process for the opposite binding. About 75 - 80 metres is a good length of string for using to hold the guitar bindings on and cotton material is needed to allow for applying heat with the heat gun as nylon breaks with too much heat applied as I found out while doing this job.

## *Cleaning Off Animal Glue with Hot Water*



*With the top purflings and bindings now glued on, the guitar was looking a bit worse for wear and so I now had to clean it up a little bit and was advised that instead of scraping away the glue it is safer to clean up the guitar using some boiling water on a*

*clean white rag so I set up a pot beside where I was working and once boiled I gradually cleaned away the glue.*



*This was quite easy in the end up and got the guitar looking really nice again without needing to take any material off by scraping or sanding.*

*Important was not to soak the guitar too much so I figured ringing the cloth out a bit every time before re applying meant I wasn't saturating it.*



*Next would be to repeat the entire process on the rosewood back.*

## Cutting Back Purfling Ledge



Again using the Purfling Cutter with the curved edge against the ribs, I lightly



cut into the guitar back just about half a mm less than the combined width of the binding strip plus the four veneers that will be the purfling. Once scored fully along both edges I then chiseled away leaving one third of the back thickness as a ledge onto which I will glue the purfling. I had to turn the chisel side-on at times to break away the wood a little. Also used the scalpel to take the line I made with the purfling cutter a bit deeper.



When I reached the heel cap area I already had decided that the purfling would stop just short and move onto the heel cap to make some feature of the whole thing. Once I had scalpeled this area the way I wanted at this stage, I flat-filed all along both edges trying to keep a visual check that the depths all along were deep enough to take the purfling. The flat filing was done with the blind edge facing into the middle so that no material was being filed off the curves cut with the purfling cutter. Occasionally I would use the other edge to take out an angle on a curve but very lightly.

Once this was done it was onto the actual gluing on of the purfling. At this stage I realised I had taken too much off the edges and to compensate for this I had to add one more veneer of purfling making it 5 lines consisting of red, white, black, white, red. This followed the pattern of the front with just one red added on the outside edge.



## Gluing Back Purfling and Cleaning Up



With some new animal glue on the boil and all the pins nearby (on top of the guitar), I first chiseled a clean edge on all five veneers ready to glue at the end block end of the guitar.

The first part was a bit tricky due to the end block having no edge to pin into so I had to carefully put a pin into the top of the end block inlay and then also masking

tape the purfling down and quickly get some more pins along the purfling to get the ball rolling and get this initial part secure enough to continue on. Once I was happy it was glued secure it was just a matter of gluing up about every 4 inches along making sure to brush glue thoroughly between all veneers and on the ledge, then hammer a map pin in every 1 cm or as close to each other as possible. This was because the rosewood was a bit too hard to press the pin in unlike the spruce top.

Once I reached the heel cap area I had to very carefully score down with the scalpel and break away each individual veneer to get it fitting to the design I had decided. After this it was neatly glued in place. I then did the same for the other half of the guitar back.



The next day when it was all dry, I carefully took out all the pins and gradually chiseled away with a newly sharpened chisel most of the excess height of the purflings. I went slowly to make sure I didn't damage the red veneer at the edge as this is very easily broken. Once taken down close with the chisel, I then used a newly burnished scraper to bring the purfling flush with the back.



Thankfully in the end all the purflings stayed together and there were no gaps which I thought it looked like there was going to be after taking the pins off.

## Chiselling Back Binding Ledge



I had already marked out the initial cut for the back binding earlier but decided to just go back over it as there was some animal glue in the cuts I had made so I used the purfling /

binding cutter to go along all the edges. I then began Chiselling along these areas making the ledge to take the binding. I noticed the wood of the ribs was breaking a bit in some of the areas where the animal glue had been a bit heavy. Paul mentioned this and said I should have cleaned off the animal glue with hot water to make sure this doesn't happen and also to keep the cutter blade sharp. Once I cleaned off the animal glue with the hot water things went a lot better.



I carefully chiseled away the rosewood at the edge trying to make sure I didn't gouge into the red line of purfling. The purfling is a guide as to the depth the rest of the wood has to exactly come down to. After this I then went along the whole length with the flat file (blind edge in) while testing the fitting of the binding onto the ledge.



With the ledge not too bad I then had to deal with the heel cap area and at this point i decided to patch up a piece which was looking a bit fragile. This was a bit tricky involving the tiniest of fragments of red veneer cut and glued in with titebond, but I managed not too bad having dropped the piece onto the floor about 10 times! The white arrow shows the first red veneer repair.



Next I had to chisel in a slot for the binding to partially go into at the heel. I used the 2mm chisel for this job. While doing this I leaned too hard on a scalpel blade and it broke and I cracked another piece of the red veneer so had to patch another even smaller piece in place with titebond.

## Bending and Trimming Back Bindings



With the ledge close to ready, I then set up a bending iron and left it at high for 20 mins and began the process of bending the bindings. I measured the position of the waist using a piece of string and then transferred it to the binding.

Here I made a really silly mistake by breaking another 2 bindings at the waist because I didn't wet the wood beforehand. This brings the total to 4 now so Paul helped me bend the waist curve which is the most difficult and after this the lesser curves I was able to do



without any more bother.

The red picture above is

a photo I took from inside the guitar showing the light coming through the thin spruce soundboard.



After breaking the 2 bindings I made sure to give the bindings a good soak with a wet cloth before trying to bend them and also I made sure to move the bindings around a lot on the surface of the iron to get the wood evenly heated rather than just at one point. The flat side of the iron is good for getting a lot of heat into a wider area.

When I reached the heel end of the guitar at the neck body join, I taped each binding in place and measured very carefully then trimmed the binding using the scalpel and chisel so that it would slot into the edge of the heel cap area as shown in the diagram on the left which I cut at a diagonal.

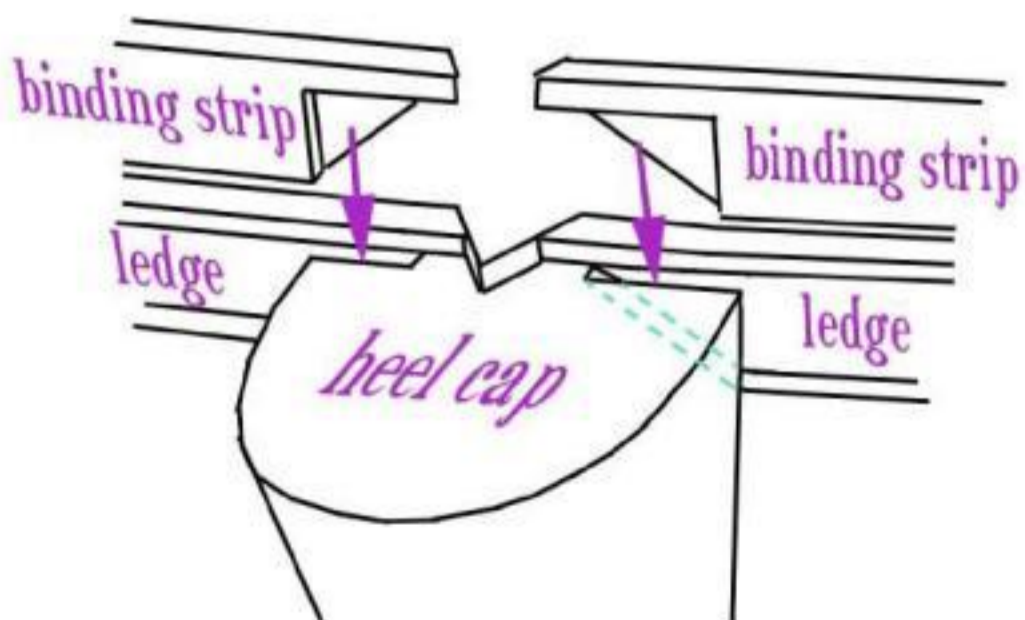

## Gluing Back Bindings and Cleaning Up



Before gluing I went round with the cabinet scraper edge to square off the ledge. When cutting the binding ends for fitting flush with the end block patch (left) I made a mistake once more on yet another binding and cut it about 3mm short of fitting and because the binding was cut at a diagonal at the heel end to fit the slot, there was no extra wood to fill the space. Lesson learned here would be to make sure that the binding goes into the heel a good bit as an escape route for any problems here.



I then had to bend another (5th binding). This was not as good a match to the others but close enough. Once bent this time I made the slot at the heel a little deeper to get more of the binding in place.



I then animal glued the rib in place as before, maybe a little bit in a hurry this time as I had started the job late in the day which maybe I shouldn't have done. I glued on both back bindings at once which was fine but it then meant that I had the full edge to worry about when tying the guitar up and also because of both ribs being forced against the guitar with the string, there was a certain amount of gaps appearing due to this. In the end after a lot of sweating to get the string covering every area of the binding that was being glued, it looked not bad. I used the heat gun on it a little bit but left it for the night. The next day I cleaned off the excess glue again with hot water and lightly scraped around the top of the bindings. Bill helped me to spot bits of the lining that could do with a bit more gluing and tying. There were only two of these we thought were really needing fixed so I brushed on some hot animal glue and rubbed it into the gaps then wiped clean and tied up the affected areas. I then applied more of the heat gun and left to dry for the rest of the day.



Next Day I sharpened the scraper and then scraped down all the binding edges trying to make sure not to thin them too much on the outward showing edges but trying to bring them back down to being flush with the ribs. This went quite well and it was quite nice to see the guitar cleaned up a little bit as it is starting

to get a bit grimy especially the soundboard. I then gave it a light sanding as well.



# Heel Cap Maybes 1

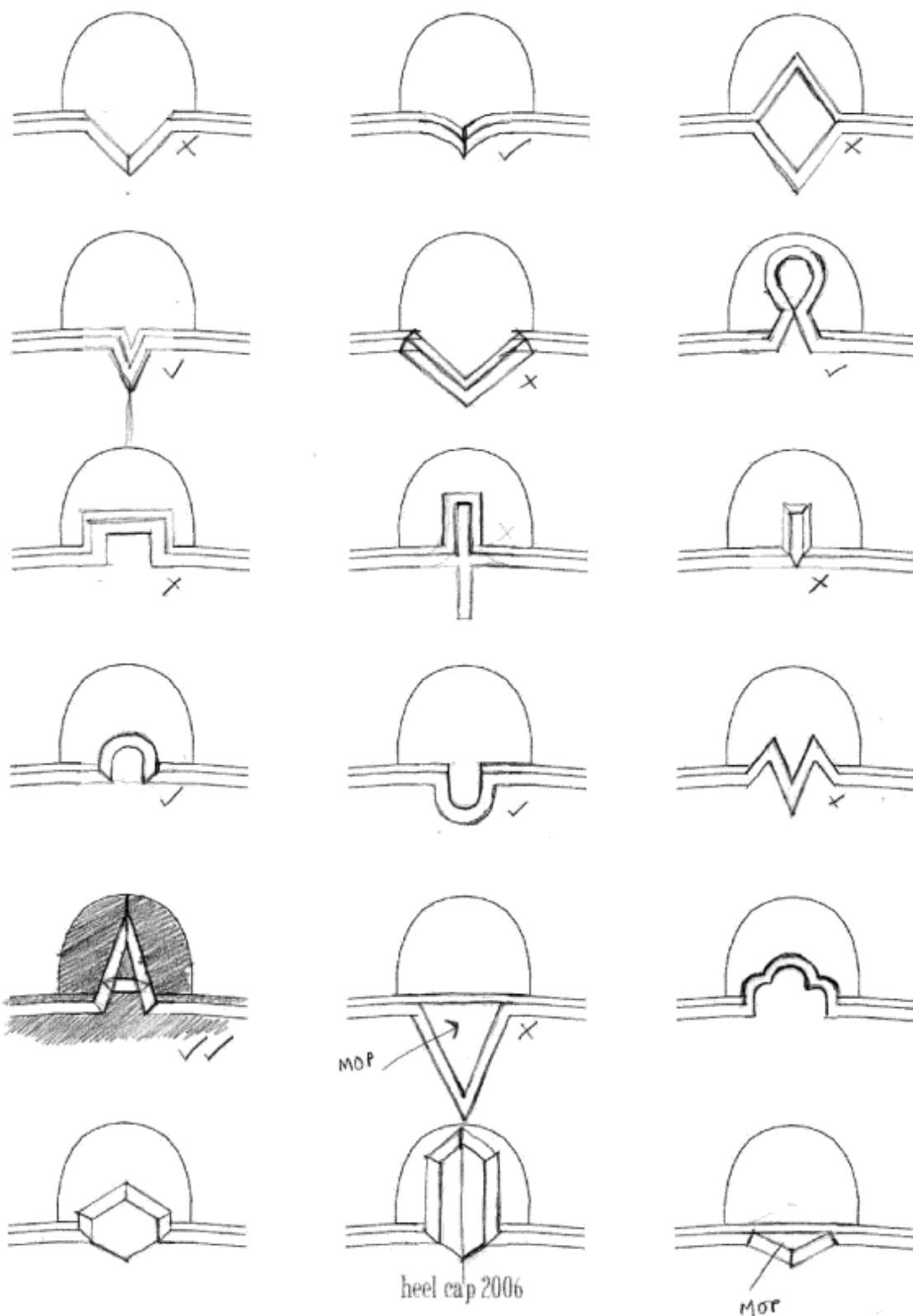

# Heel Cap Maybes 2

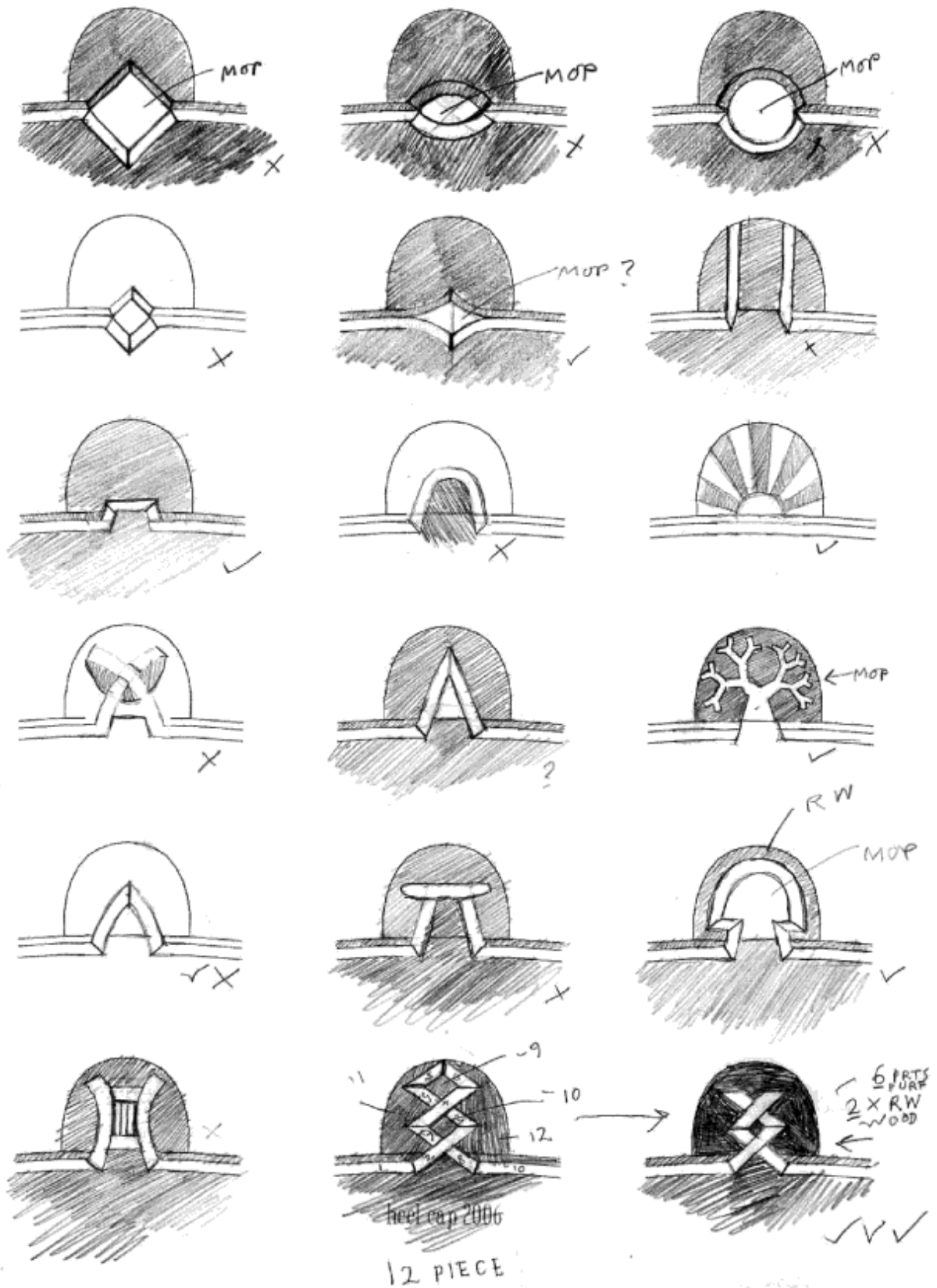

## *First Loop Heel Cap*



## First Heel Cap Design

For the heel cap I decided on this loop idea where the purfling does a loop onto the cap and continues back down the other side. To do this I had to make a drawing (top left). Bill suggested wrapping the purfling veneers one at a time around something like a drill. The dimensions needed from looking at the drawing suggested a 6mm drill would be good and so I drilled it into a scrap of pine and left it in the wood for bending the veneers around. I

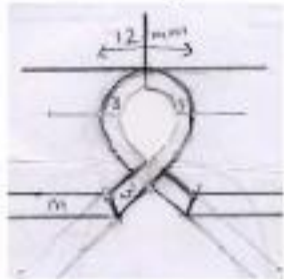

used the original drawing for exactness to mark the pin holes for gripping the veneers in place. I then soaked the veneers in some water for about half an hour to soften them for bending. Once soaked I gradually forced all five layers together around the 6mm drill, pinning in place every now and then, until I managed to overlap them. I left them for a further half an hour



to allow the wood to settle into shape. After this I took out the pins and carefully glued all the layers together with titebond quickly and pinned it all back in place. I left it to dry overnight then made a half lap joint on both overlapping edges using a scalpel. I then glued this joint with titebond.



After this I sanded both faces of the loop to even up all the veneers. Next I traced the loop onto both the guitar and the rosewood for the cap using a fine pencil. On the piece for the cap, I drilled out the area to be waste wood using a



very small drill bit and cut the 2 pieces apart with a scalpel. I cleaned up the teardrop shape piece for the centre of the loop using a flat file gradually trying to fit it in place. For the piece of the cap around the loop I used a



round file to shape back to the pencil lines until I had the loop fitting in place. Once both were fitting flush with the loop, I carefully drew on and chiseled and scalpeled down the area where the ends of the loop fit to the guitar purfling. Once the cap was fitting I glued it onto the guitar heel with



animal glue and clamped it with a G clamp and two cauls. There were a couple of gaps which I filled up with rosewood dust rubbed in with titebond. An hour later, I sanded this back and it looked fine. I then went on to blend the cap edges into the rest of the heel using the chisel and file. I also had to sand the heel a little bit at this point and this made me see I had made a few mistakes such as not checking the flatness of the heel before gluing the cap and also some of the binding where it meets the heel was uneven due to the chamfering I done to get it fitting. Because of these mistakes i decided to remove the cap and start again!

## New Heel Cap

For the new heel cap I did some more designs and came up with this design on the right. I cut the old heel cap off down to near the level of the binding as I planned to make a thick heel cap with a white line to match the binding. Once cut off I filed and sanded the level down to where the white line veneers would be fixed to match the binding. With this done I drew on where the new cap would fit into the guitar back and scapelled this edge and chiseled it down to the same level as the rest.



I then marked out the sizes on the rosewood cap and gradually fitted it

using the flat file to hone the rounded side to just about 3 or 4mm too big. I then glued on the 2 ply white veneers with titebond to give the effect of the continuing white line of the binding. Once dry I trimmed away the excess

white veneer and glued firmly to heel with a G clamp and 2 cauls.

After this I filed the cap flush with heel then marked centre line along guitar back. I then drew out dimensions of pearl inlay and tested and finally drew on the piece of pearl. I cut out shapes using a piercing saw making sure to wear my mask throughout and had a damp cloth to deaden the dust from rising. Once both pieces were cut I traced them in pencil onto the cap and then scalpeled within the lines checking to make sure of fit before going too deep. I then chiseled with a 2 mm chisel to nearly the depth of the inlay and gradually fitted them.

To glue in place I used 2 part epoxy araldite glue followed by some of the same mixed with dark rosewood for gaps and then clamped in place with a G-clamp and 2 cauls.

Next day I scraped and sanded till all epoxy glue was gone. The result was quite nice overall and neater than first cap.



*Idea for heel cap through to real heel cap*

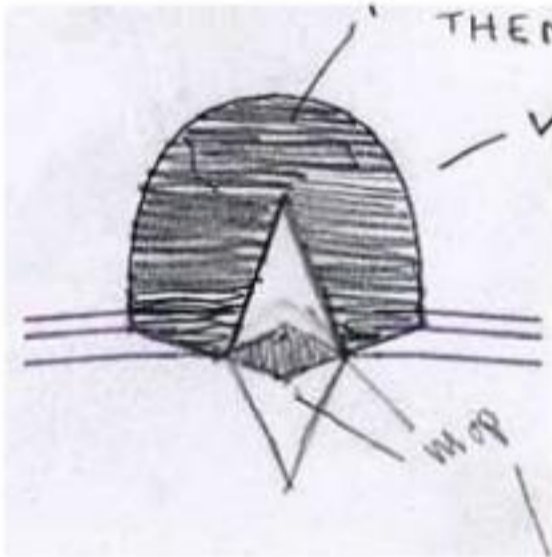

## Fingerboard



flat along the length was not as important as getting it flat along the width. This is because there would be a further feathering of the side to be glued down to account for the neck angle.

At one point it was slightly high in the middle so I used a piece of folded paper

underneath to try to level off the middle with the plane. This worked really well though a lot of checking inbetween was needed. It was important here to have the plane set to take only a very fine shaving almost a scraping. Again at one point it seemed the wood was now rocking on the flat surface as though skewed so I put paper under the corners to try to trim / level them down with the plane. Inevitably it seemed the side I had given the least attention to turned out to be the flattest! After this I had to shoot one edge of the fingerboard completely flat and this was checked using the straight edge and again light scrapings with the plane proved the best. Once this was flat, I then marked on the centre line measured from the squared edge to the centre and also compared this to the guitar as my fingerboard seemed very close to the size it would be. I worked out that 52mm at the nut end and 62mm at the 12th fret would leave me just enough width at the soundhole end and no more. I then had to completely square up the nut end to correspond with both previously squared and flattened surfaces.

With the heel cap now finally done and in place I was able to start getting the Ebony fingerboard ready.

Initially I started planing it on the bench but worked out the bench was not flat so got a big flat block of wood to plane on top of and screwed in 2 end stops like in the Roy Courtnall book to hold it while planing. I also cut off the excess length of the fingerboard leaving maybe 15mm more than needed to make planing as easy as possible. Getting the two faces square was not as easy as I thought even with a freshly sharpened number 7 plane. Getting the wood



## Marking out Fret Slots and Cutting



With the Fingerboard gluing down surface as close to flat as possible I marked on a centre line along the entire length with pencil initially making sure that the centre corresponded most importantly to the edge I had just

planed flat. The try square will be placed along the flat edge of the fingerboard so the slots can be cut at exactly a right angle to the flat edge. Once this centre line was marked on I scalpelled along it lightly so as not to

lose the line if the pencil is rubbed off. After this I took my fretscale measurements as calculated on the computer and began marking them on in pencil along the centre line, starting at the Nut end. Once all were marked on, I then went back and re-checked and then re-checked again to make sure that each fret mark was exactly in the right place according to the calculations provided. Once happy that these were exact, I then very

carefully used the try square, along the squared edge and remarked each fret position using the scalpel, again to ensure no errors happen due to loss of pencil marks. At this point I had to take my new dovetail saw and reset the teeth to make a narrower sawcut (kerf) when cutting the fret slots. This was done by hammering the teeth flat on the solid metal surface of the pillar drill table. After this I checked the saw cut by sawing into a scrap of ebony and hammering a piece of fret wire in place. The fret slots were to be cut 2 to

3mm deep and so I then made a stop for the saw so that it would cut no deeper than 3mm. This I made from a scrap of plywood, double sided onto the blade right up to the spine. A piece of Beech might make a more permanent and solid solution for this. With the fingerboard clamped in place on the bench with 2 clamps I then also clamped in place the try square just in the centre of where the saw

mark would be going. It was important to make sure that the saw blade was hitting the scalpelled fret mark centrally and not over on any one side. Having the try square clamped down really helped keep the whole set up more secure as the narrowed kerf of the saw made it a little bit sticky while sawing. With each fret slot I done a visual check to see I had went down both sides equally to 3mm. Also a mistake I made here was in not protecting the bench underneath where I was working and so the bench got a good 10 slots worth scratched into it with the saw edge before I noticed and placed a scrap of board underneath.



## Trimming Fingerboard and Aligning for Gluing To Guitar



With all the slots sawn into the fingerboard, I was then able to double check the taper from nut to soundhole and then scalpel this marking in place and then take off the excess wood using the band saw leaving a good 3 to 4mm to plane off using the shooting board to ensure a nice flat edge.



Once the fingerboard taper was complete, I then went onto scraping down the area on the guitar neck and body onto which the fingerboard would be glued. While doing this I must have went a bit too far in my effort to scrape off the glue from the soundboard and when I checked again with the fingerboard I had made a bit of a dip on one side under where the fingerboard sits over the neck body join. This was on the opposite side to the scooped area I made much earlier on (page 26). I tried to remedy this by taking a shaving from a scrap of the same cedar and gluing it in this dipped area to try to fill the gap a little.

With this repair done and planed carefully back as best as I could manage, I then went onto re-mark the centre line on the guitar from the nut end to end block end to make

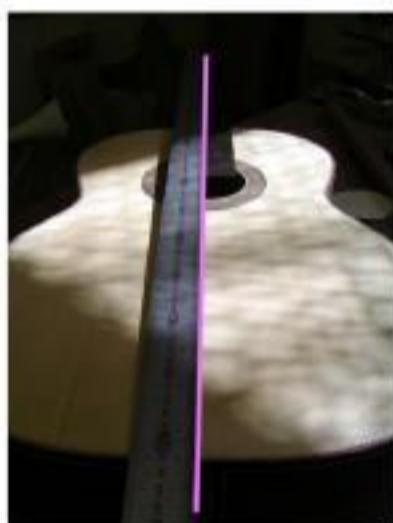

sure that I would be gluing the fingerboard in place properly. With the centre lines re established on the guitar I then had to align the fingerboard to match up making sure also that it was sitting evenly over the soundhole and not veering either way to the left or the right. With the

fingerboard on the guitar, I also used the straight edge to align it and once totally sure I had it in the right place, I used a cam clamp to secure it temporarily while I drilled in two small 2mm drill bits into 2 fret slots at the 2nd and 11th frets to act as gluing guides to make sure the fingerboard wouldn't slide out of position while gluing. Once the two drill guides were in place I then marked out the near semi-circular line for cutting out the end of the fingerboard by aligning the 84mm diameter circle template over the fingerboard end and traced it on with a white pencil. I bandsawed the excess away and tidied it a little using some sandpaper doublesided around an empty aerosol can. The aim now was to take a short pencil and from inside the guitar trace the actual soundhole edge onto the fingerboard edge and this should give close to the exact line to sand back to. Hopefully this would take care of it before gluing and would leave minimal sanding to be done after it is glued in place.

## Mistake with Neck Angle and Gluing on Fingerboard



During the process of aligning the neck in preparation for gluing, I re-checked the neck angle which I had previously established with the neck angle stick while gluing the guitar back on. The neck angle now seems to have changed either due to the changes in humidity in the workshop or possibly even that the neck angle stick was not made exactly as it should have been in the first place.

Hopefully though this error should be able to be remedied by planing a slight downward angle on the fingerboard from the Nut getting thinner towards the Soundhole and this angle will give the same desired effect allowing the strings plenty of space to vibrate. I made the following full size drawing to help me understand how this was going to work using all the exact measurements.

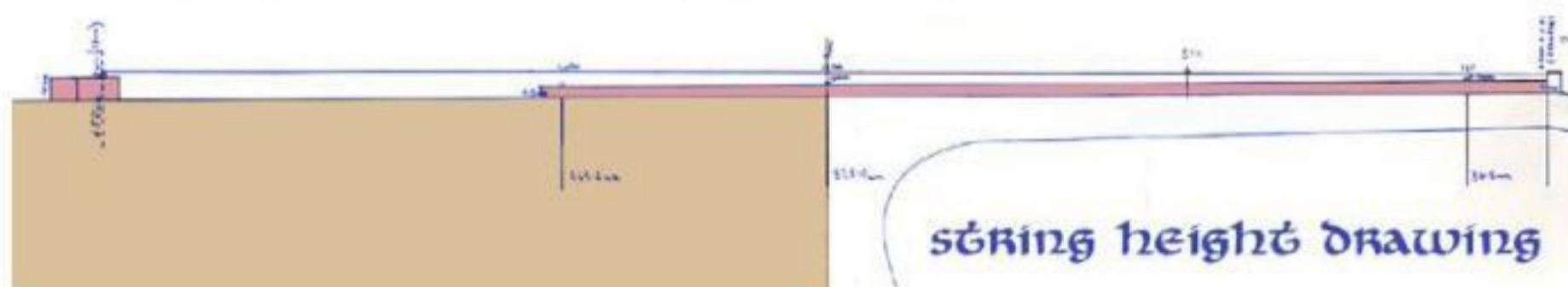

With the end of the fingerboard now matching the soundhole as best as possible it was time to get it glued onto the neck and guitar. For this I cut a clamping caul from mdf the same size as the fingerboard with 2 larger holes to fit loosely over the two drills placed in the fingerboard for holding its position while gluing. Underneath as a caul I used the spine of a telephone directory which was perfect for taking the shape of the neck. At the heel I had another caul of mdf and in the soundhole itself I placed 2 Cam Clamps clamping onto another piece of phone directory on the inside of the guitar. All along the neck I placed 4 or so G clamps to make sure the force was being evenly spread. I left overnight to dry and when I checked the next day I noticed just a small area of the fingerboard was not completely fixed down around the neck body join area so I had to push some titebond in with my fingers and then reclamp the area. This seemed to correct the mistake fine.



## Planing Fingerboard, Re-cutting Fret Slots

With the guitar neck fully glued in place I then spent a few hours roughly tidying up the neck with a sharpened cabinet scraper bringing it in close to the fingerboard edge. The neck was made a little wider than the eventual fingerboard size to allow



for this. At this point I filled in a gap on one side of the guitar heel where it meets with the rosewood rib. I filled it with some titebond glue and then forced mahogany dust from the scrapings into the gap. I left it to dry for a few days and it seems to have worked well.



Next stage was planing the neck angle for which I prepared a number 5 1/2 plane with a sharpened blade. In the end I had to sharpen the blade 3 times during levelling to stop tearing the grain of the ebony. It was worthwhile to make the effort to sharpen as apart from it improving the accuracy of the

planing, it also showed that the ebony has a really nice slightly twisty grain pattern. I had to plane from the soundhole towards the nut end due to the grain direction the way I had orientated the neck on the body. This was fine and I supported the guitar with 2 blocks on the shoulders either side of the neck and used a strip of carpet along the blocks to further protect the ribs. I made sure to protect the guitar soundhole and body from the plane by covering it with a template made from thin ply and a doubled sheet of paper. I drew on with pencil the planned taper from nut to end of fingerboard which I had worked out in my full size drawing. 6mm high at nut down to 4.5mm at soundhole end.

It took some time to get the surface planed down but eventually I got there in the end after a good few checks to see what the string height was looking like using the long straight edge. In the process too I also managed to plane out the 20th fret slot that

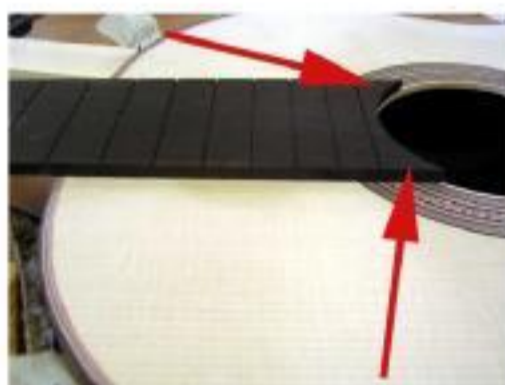

I had earlier cut in error. After this I smoothed it flat using a long sanding block again checking for flatness with a straight edge. Finally I had to then re-cut all slots on the fingerboard checking with each that I was taking them down to at least beyond 2mm and 2.5mm to be sure.

## String Relief

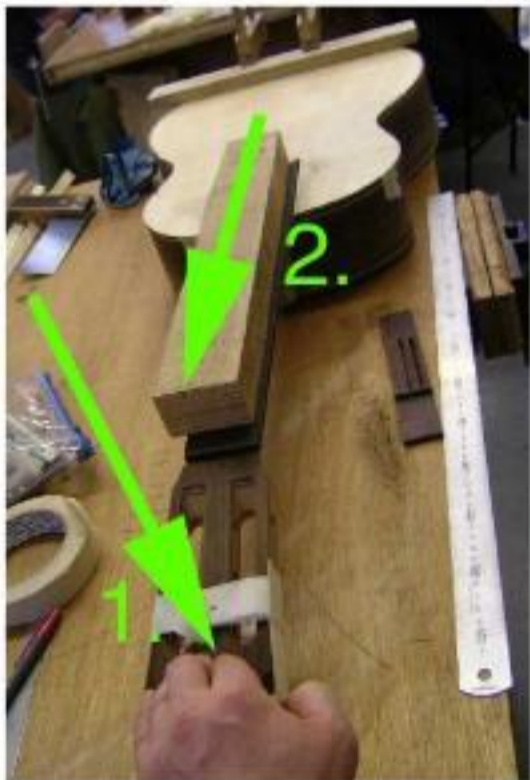

The last thing I had to do before fretting the guitar was to now make a slight dip in the fingerboard centred around the 5th fret. This is to allow the strings a little bit extra room to vibrate on the nut side of the neck where there is less room due to the closeness of the frets to the strings. The amount to be taken off though is slight perhaps the thickness of 1 sheet of zerox paper paper on the bass side of the fingerboard and a half as thin sheet on the treble side. This in combination with the string tension should leave enough free space to allow the strings enough room to vibrate without buzzing against the frets. To do this I had to clamp down the end block end to the bench using two cam clamps. I then had to push the headstock down with one hand whilst simultaneously sanding the fingerboard with the 5th fret as a central point of focus, with a bit more emphasis being placed on the bass side when sanding. I did this a few times until I felt I was seeing some kind of result when checking with the straight edge. A good thing might also be to consider some way of gently clamping the headstock down to keep it in position while sanding away the string relief.

## Hammering in Frets and Filing Ends



After this I was able to begin fretting the fingerboard. Frets one to ten were done with the neck support block directly underneath each fret to be hammered in place with the neck support itself centred on the leg of the bench to direct the force of the hammer blows down and away from the rest of the guitar. For each fret I had to make sure my saw cut was down to at least 2mm as the fret tang itself seemed to be about 1.5mm.



I cut each fret with the fretwire cutters about 2mm longer either side than needed. Longer than 2mm meant that the fret may not get hammered in place completely flat as the hammer might bend it over the edge a little bit. Initially the fret was tapped in place at the edges then along the centre to position it in place.



After this it was hammered fairly firmly using dead-blows to keep each hammer strike under some amount of control. Once in place I then used the fretwire cutters to crop the wire up to the fingerboard edge. Frets 11 to 14 were done with the guitar on the rug holding down the heel and centering again over and onto the bench leg.



After fret 14 there is no support under the fingerboard and so for frets 15 to 19 I had to hold a heavy steel block wrapped in masking tape inside and underneath the fingerboard while also holding the guitar this time on my lap. These frets were then hammered in place in this position as shown in the photograph.



Once all the frets were in place I used a file inserted into a block at an angle as shown to file down the roughly cut fret edges to a nicer smooth edge. Important here was to keep an eye on the progress and to make sure not to file away the edge of the fingerboard. I also then flat filed the tangs on the fingerboard sides making sure not to file into the ebony itself.



## Cleaning Up Before Polishing

Next was to clean up the neck shape using the scraper initially to slim down the neck which was not quite thin enough to be comfortable for playing. I thinned the heel area firstly with the scraper as I had previously filled a slight gap between the heel and the body on one side with the same wood from the neck which I had titebonded in place. This cleaned up very well and after this I finely sanded the same area to neaten it up.

Going on from here I then began to work along the neck towards the head trying to refine the

curve which moves into the fingerboard edge and trying to round it towards the neck centre line. At the volute area of the headstock I used a rough rasp to try to take off more material as it seemed to be looking a bit square. Sandpaper was also useful here for rounding the profile of the neck as shown. I also tried to feel with my fingers for any high areas or to feel whether I was working symmetrically.

At the volute area I worked the shape more finely with a round needle file quite a bit. At this stage I made a change of plan with the headstock shape as I didn't like the way the back curve of the headstock was visible when the guitar was viewed from the front so I redrew the volute shape to be a full semi-circle joining on to the back of the headstock. This looks quite nice in itself and it has corrected what I didn't like about the headstock front view. Initially I drew it on with pencil and then I used a very sharp 5/8 firmer chisel to cut away the excess material. This worked really well and after this I used some medium grade sandpaper to fine tune this area.

After this there was a good bit of trying to blend the heel and volute into the run of the neck and also keep it symmetrical. The next day I could see the heel was slightly off to one side - I took a photo of it straight on and mirrored the side that was thinnest and pasted the outline over it to give me a guideline as to how much material need to be shaved off. After this I sanded down the guitar soundboard getting ready for polishing.



## More Cleaning Up Before Polishing



While cutting the slots for the headstock I chipped the rosewood edges and dug in a little to the sandwiched veneers so following Bill's advice I filled the gaps with rosewood dust and dropped in superglue having taped off the area with masking tape and using a 6 inch rule to dam up the area while the glue was setting. Once it was dry I very carefully began filing with a needle file making good use of the blind edge to avoid cutting into any more of the



headstock. I also re-used my sanding wedges to try to clean up the area to a bit of a finer finish.



cut back with the scraper to try to make it more alike on both sides. The heel cap seemed to be slightly bigger on the side to be cut away so this gave me just



enough extra to make it look halfway decent without ruining the heel cap shape.



Next I steamed out some really rough grit marks on the soundboard using the soldering iron and a small damp cloth. This worked reasonably well but there were some marks I couldn't get out

After this a final sanding down using a rubber sanding block and fine 240 sandpaper.

## *Filling up gaps under frets with veneer*

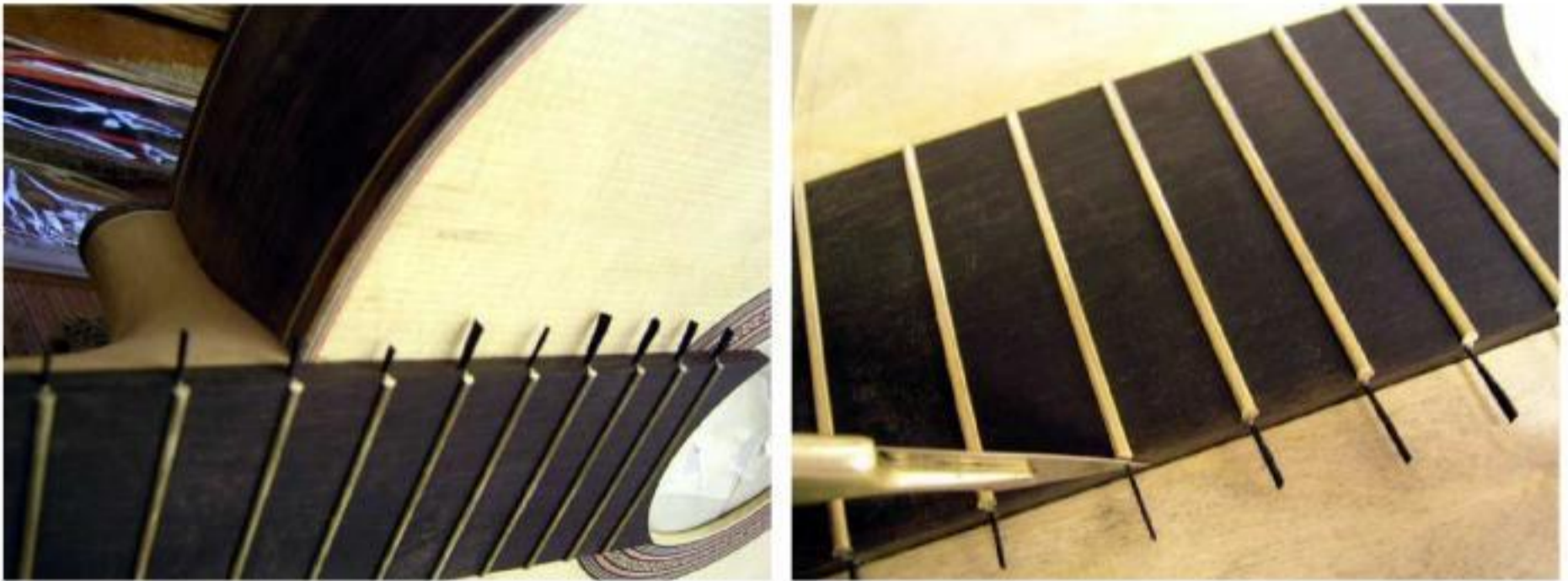

*After cleaning up the fret edges I then had to fill the gap of about 1mm below each fret on both sides of the fingerboard. I decided to choose gluing in small pieces of black veneer cut into a slight wedge shape using titebond glue and then wedging them in place, being careful not to dislodge the fret. Afterwards I felt maybe I should have used superglue as there were still slight white marks where the titebond has set.*

*After gluing in place I began to trim them back with a scalpel making sure the soundboard protector was in place. I cut each piece of veneer filler one by one and afterwards lightly sanded along to clean up the rough edges.*



## First Brush Coat of Polish before Grain Filling



Next I brushed on a coat of polish to the top of the guitar and to the neck and headstock to seal them before attempting the final sanding of the rosewood back and sides. With these areas protected I went on to use the rubber sanding block with 240 grit paper to clean up the back. The back had a fair few dents

and scratches so I had to revert to the rougher 100 grit paper for a bit and then also used a scraper to further smooth the back.

Once happy with it I moved onto the ribs which seemed ok but which I later on discovered needed more serious sanding (next page). After sanding I cleaned up the guitar with a tack-rag to remove all the dust. I then went around all the purflings with the scraper edge to clean them up again as they were a bit clogged with the rosewood dust. At this point too I noticed that the soundboard was looking a bit stained with rosewood. Later on I found out that



the polish I used here was maybe a bit too thin (should have been 20% meths) and this is probably why this happened.



Once all this was done I further went round all the purflings and bindings with a thin line of polish to protect them before applying polish to the back and ribs. This was again to stop the rosewood bleeding into them any further. Once this was dry I then applied a coat of polish to the ribs and back area.

After the first coat of polish I decided to use some acrylic paint to disguise the mistake on the headstock which will be seen on the players side. Even though there is 3 veneers plus the rosewood I figured that the main thing would be to draw in a line matching the lightest white veneer as the rest of the veneers being dark were not so noticeable. I



very carefully mixed up a creamy colour to match up with the colour of the lightest veneer now that it was slightly yellower due to the layer of polish. Using a very fine brush I painted on a small line on the same spot on both slots and cleaned back the

paint using a scalpel to thin the line a bit. Once I was happy with it I brushed over some polish again on these areas to seal in the acrylic. Worked quite well.

## Grain Filling



With the whole guitar sealed with a coat of polish I was now able to apply the thixotropic grain filler mixed with carbon black (soot) to the back and ribs. Firstly I mixed in the carbon black to a quantity of the filler and had at hand a rag to apply it and about 10 squares of rough canvas sack cloth for rubbing the filler off the guitar after applying it. With gloves on, I rubbed in a quantity of the filler to about a quarter of the back, trying to work it into the grain until I had spread it evenly. Waiting for about a minute until it started to look matt, I then used a piece of sack cloth, working vigorously to remove most of the excess, this time going across the grain to make sure I didn't lift out the filler that was in the grain. I repeated this process across the whole back. The ribs were much the same except

I had to do it in about 6 stages to cover all the curves and end block end. Following this I used a little natural turpentine to clean off the filler which had gotten onto the top while doing the ribs. This cleaned off ok. I also used some turps on a rag to run over the ribs and back to take off a bit more of the filler than I had been able to get off with the sack cloth. It was at this point that I noticed various scratches (see above top right) on the ribs which the filler had highlighted. Paul noticed that the bindings were not flush with the ribs so that when I sanded them the block would not have been affecting certain areas and so that was why I had all these scratched areas. This mistake meant the next day I had to scrape down the bindings flush to the ribs, fully scraping off all of the polish layer back to afresh. Most of the grain remained filled though so I will see if I have to re-grain fill;

probably more than likely. With the ribs now looking really nice and flush with the bindings I then put on one coat of polish to the ribs (newly mixed with 20% meths this time). Inevitably I noticed the soundboard had a few rosewood stains in it from scraping away at the ribs and they didn't seem to want to come out, either with the tack-rag or with a little turps so next day I had to set out to lightly sand away these stained areas until I had gotten it clean again with a cork / mdf block. Also there were a few bits of grit wedged in the wood so I had to do more steaming with the soldering iron to get it looking good again. Lot of work but definitely worth it. After this I applied two coats of polish over the space of the day and will do a third to try to make sure I don't do any further damage to the soundboard.



## Re-grain filling ribs & Superglue Filling



I lightly sanded the back of the guitar with 240 grit paper to de-nib it and take away some of the small scratches that had appeared from the first grain filling. I also de-nibbed the ribs and then went on to the grain filling stage again and followed the same process as before, covering both the ribs and the back. When this was done I cleaned up the top using some turpentine on a clean rag. I also then applied a third brush coat to the top to keep it protected.



The next day I sanded the grain filled back and ribs back down to the rosewood level to reveal the filled grain and while doing this took out some more scratches revealed by the filler. This was followed by a full brush coat of polish on the back and ribs.



Next day the dried polish revealed a few final dents which needed to be superglue filled. (see below left). The glue was drop-filled into the dents, left to harden, trimmed off with a sharp chisel and then scraped back flush with a stanley blade (scraping in from all directions). I also went around the bindings with the superglue too as there was still a good few dents around there from when I had cut the binding channels earlier. To finish up I also had a good look around the back and ribs closely inspecting for any more scratches and tried to sand these out carefully without removing any of the grain filler.



Next Bill suggested I use the rubber to start applying coats of polish, so I had to lightly sand down the soundboard and take away any ridges made from the brushing on process. After this was complete, I then began applying polish with the rubber (still 80% polish 20% meths. This first coat was pretty bad as I still wasn't sure of the method so the rubber was sticking everywhere, especially on one of the ribs at waist area (think I



had gotten small hairs on it and continued on applying polish instead of leaving the area alone) and I also managed to drip the polish a couple of times without noticing till too late. I fully coated it and then gave up for the day.



## Second day of Polishing with Rubber

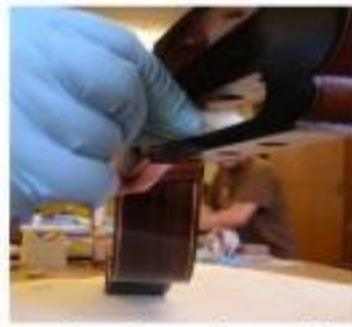
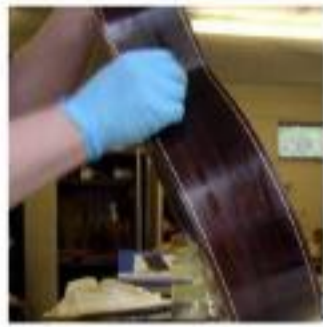

The next day I sanded the guitar back initially again to denib from the previous days dodgy polishing

job where the rubber had been sticking quite a bit. Then, still with 80% polish and 20% meths I began again to rub on polish with the rubber. This time Paul explained the process a bit more and suggested doing each area in order: {top, ribs, back, heel and some neck,

headstock, back of headstock, slots}. This way when I had gotten to the end of the process, I could then begin again at the start as the first area would have dried off enough to start re-applying. I followed this process through and it worked great and I felt I was beginning to get somewhere with it and the gloss was really beginning to look really impressive. One area

which seemed to be sticking again was one of the ribs at the waist and it looked really dark too (as though maybe I had not gotten rid of all the excess grain filler?). I thought I had sanded off this area well enough at the start of this day but it just seemed to be the same as before. A mistake I made here probably again due mostly to the sticking area on the rib was to apply too much of the white oil, which helps the rubber glide a bit more freely once the polish gets too sticky. Putting too much oil softens the eventual hardness of the polished surface and also lengthens the time it will take to dry. To fix this mistake, Paul suggested blotting the rubber on the paper as much as possible to get rid of all the polish and oil, then putting on just a small spot of meths and rubbing the guitar with this, I guess in order to

maybe help thin and evaporate some of the excess white oil I had applied. This did help a good bit and after say perhaps five to six times round the guitar in a day, I finished up the process by applying polish to the hand hold area of the neck which I had kept polish free, while keeping a grip of the guitar through the soundhole and finally I hung it up to dry. Next day I will try to sort out the area of the rib that was causing problems. One problem which I sort of half sorted was accessing the headstock slots and corners of the fingerboard / heel with the initial large rubber I had made. To solve this I just made a another smaller rubber. One thing I also thought would be handy here is a short but wide jar for the polish. 2 jars even better as could keep rubbers in empty jar when not in use saving them soaking up and wasting all the polish!

## *Guitars in Workshop Hanging up to Dry*



## Third day of Polishing



De-nibbed (lightly sanded) the whole guitar including neck, though sanded through to rosewood on bit of rib waist that was sticking with the hairs. Did this to get rid of any hairs but also as I suspected that there was still a bit of excess grain filler on the surface and that might have been what

was making it stick. When beginning to polish I coated this little area separately at first to rebuild a layer before going all round the guitar again.

Learned today from Paul, I was only to move the rubber slowly at this stage to gradually build up a good layer of polish. I was a bit mixed up with this previously and this may have been the reason the rubber was sticking the day before. I had been moving the rubber very fast with fairly thick 80% polish as though I was at much later 'spiriting off' stage where the polish will be much much thinner. I maybe made this mistake due to misinterpreting the polishing demonstrations which were taking us through the whole process in a short space of time just to show us all the various stages of attaining the high gloss finish.

After being told this, I really noticed a difference in applying the polish, It was sticking less and there were less runs as it seemed the slow movement was not forcing tons of polish out the rubber, rather it was slowly being applied to the surface with even pressure.

This process was repeated about 5 times all over the guitar today until it seemed the rubber was beginning to stick a bit suggesting that it now needed time to dry (gloss finish was beginning to get a bit matted) and so again I ended by filling in the area of the neck where I had been holding the guitar while working, and then hung up to dry once more. This day due to the slow movement while applying polish, I didn't have to use too much oil either which was good. Only used a little of it nearer the end of the process. Also the rib area where the rubber had been sticking now seems to be fine again.

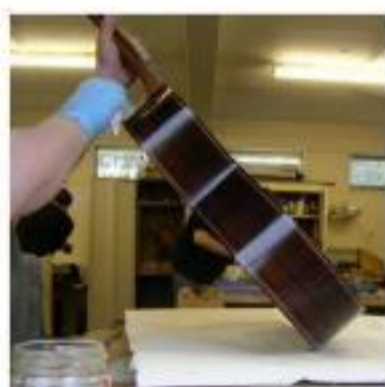

## Polishing Diary



*Monday May 22nd: Sanded back full guitar very lightly with water and 1200 wet and dry. Polished again with 80% polish but didn't add oil so it got a bit sticky straight away and so a bit of a mess. Went around guitar 3 times and then left to dry. After an hour went through exactly the same process. Left to dry for an hour again and then sanded down again very carefully to denib and smooth. Paid a lot of attention to sanding back the headstock slots as they were a bit thick with polish. Next was to go onto 60% polish and this seemed a bit easier to apply. Followed same process of 3 to 4 times over whole guitar concentrating on top to finish this time. Used a small brush for headstock slots to make a tidier job.*

*Tuesday May 23rd: Very lightly denibbed guitar again with 1200 wet and dry on a cork block. Cleaned polish out of roller holes for machine heads using the dowel with the slot in the top and some medium grade sandpaper. Thinned polish to 50/50 and applied with the rubber and went round guitar this one session today about 3 times each surface then stopped for day.*



*Wednesday May 24th: Today polished once around with 40% polish. Bill then got me to clean rubber with meths, blot out till near dry, then add some oil then before polishing surface using a faster motion to try to smooth some of the bumpy areas (called 'Spiriting Off'). Good shine except one area loaded with hairs. After this 1200 grit wet and dry sandpapered whole guitar to smooth surfaces. Was trying to sand back with the the wet and dry till reflection was looking less distorted. Next was 40% polish again with rubber then dipped in meths and blotted near dry. Only managed to*

*give guitar top a once over. Guitar top lot smoother.*

*Thursday May 25th: Today sanded back lightly with wet and dry then done one coat once over with 40% polish on rubber thinned again with some meths and blotted near dry. After this sanded very thoroughly with 1200 and this time I aimed to flatten the polished surface as much as I could so that the guitar would start to look more reflective. After this I went round the whole guitar with the rubber maybe 4 times (again mostly meths and blotted near dry). I repeated this process of sanding and spiriting off twice more, both these times concentrating more on the soundboard trying to flatten the surface with the wet and dry dipped in soapy water. Felt it was good to continue on sanding with the 1200 for a bit longer after the water had dried off as it seemed to work as a burnisher bringing the surface of the guitar up to a high gloss rather than scratching it as I first had thought.*



*Close up of Medullary Ray Lines*

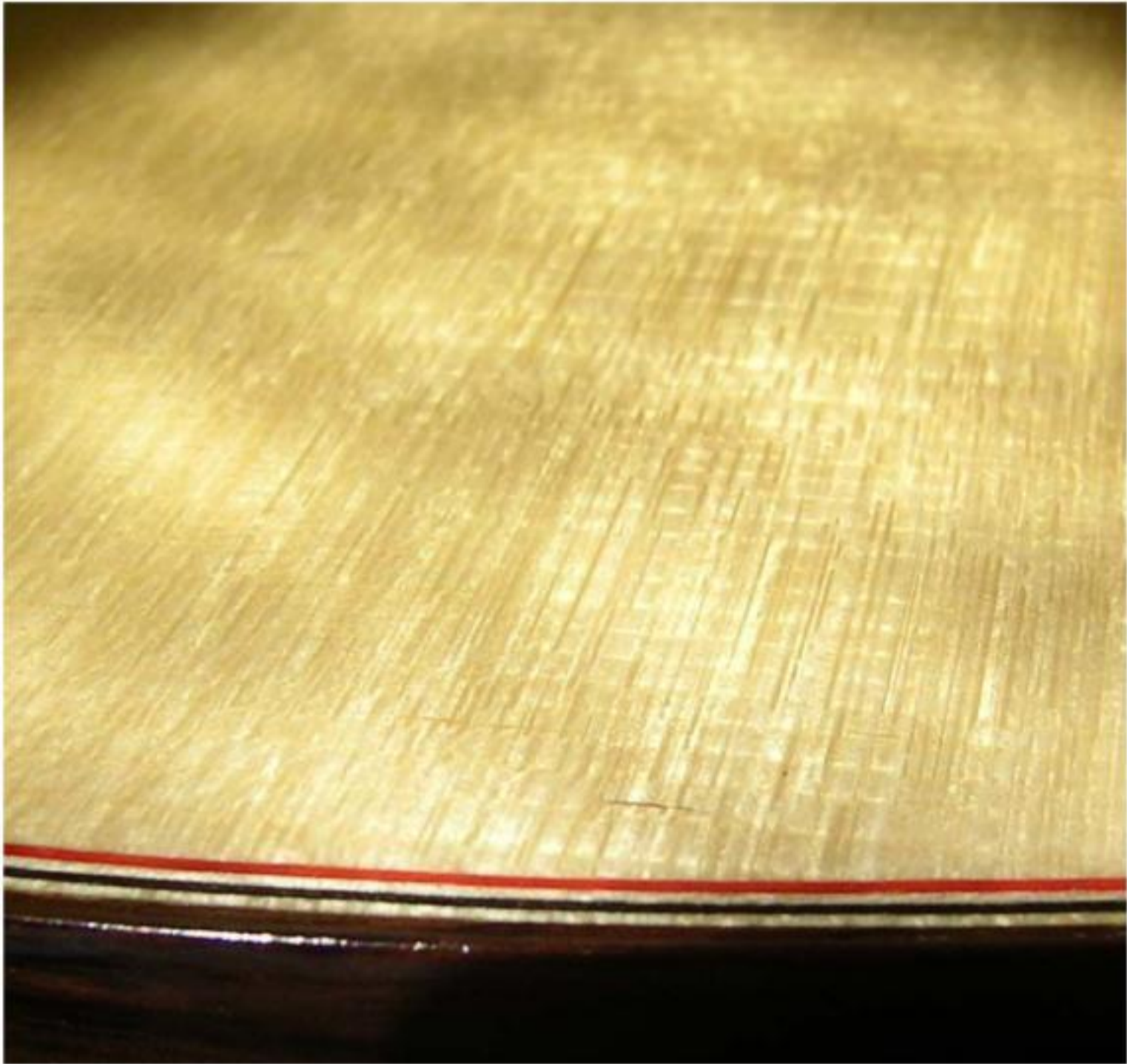



## Plan for Making Bridge

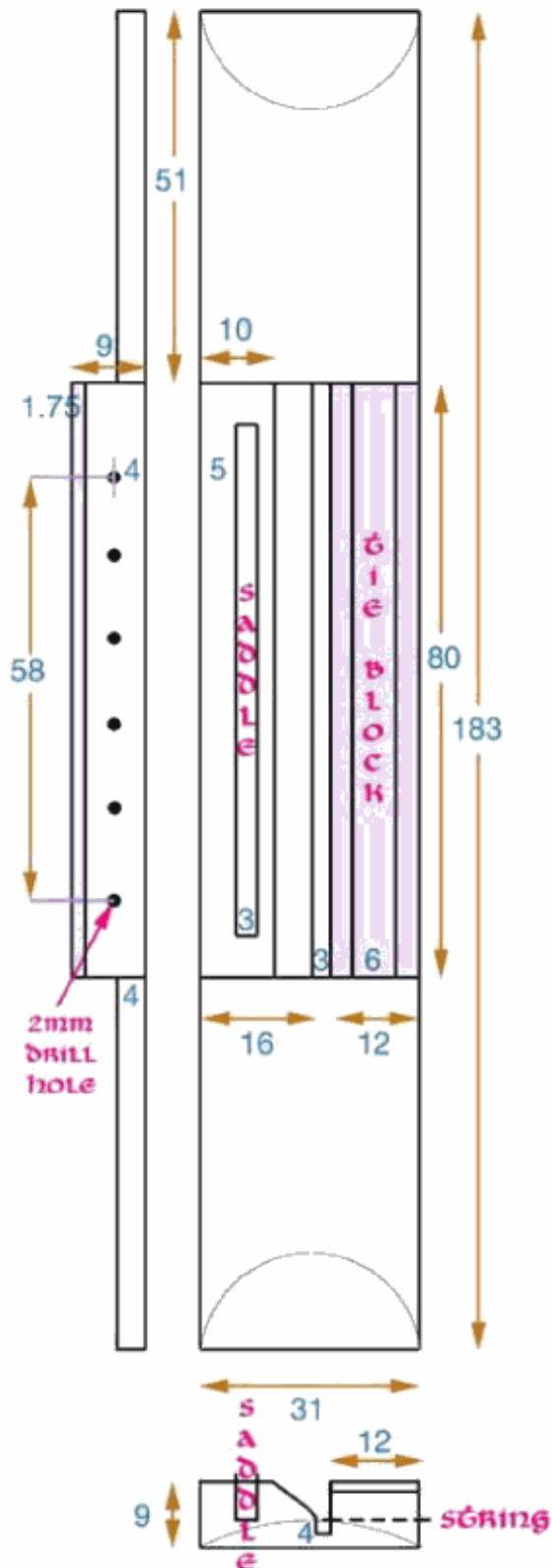

Unsure of final saddle heights until the bridge is fitted to the guitar. Should be maybe 13mm high from the soundboard in the saddle centre (see page 161).

## Making Bridge 1



To begin with I squared off the top, bottom and the two sides of the piece of rosewood for the bridge using the block plane. After this I had to fit the bridge block to the guitar soundboard curve so initially I measured down the neck the 625mm from nut to saddle position and lightly pencilled on where the bridge would roughly be positioned. I then used the cabinet scraper to create a slight hollow lengthways forming it into a matching curve to that of the soundboard. Likewise I had to make a slight scooping out with the scraper along the width as it is better to have a hollow when gluing.

A good way to test that it is fitting well is to tap on it all over to check that the vibration from tapping is transferring through to the soundboard and being amplified a bit. I then block planed the bridge down to 9 to 10mm thick.



## Making Bridge 2

To get the exact position of the bridge I had to place the bridge at the exact 652mm spot, remembering that this 652mm which is where the saddle centre will be is around 7mm in from the edge of the bridge. (later found out the 652mm mark on the saddle is at the first third mark closest to the soundhole). To do this I marked a light pencil mark of 652mm and then took 7mm back in order to give me a mark onto which to lay the bridge edge. To 'Triangulate' the position I had to



measure from the nut corner down to the corner of the centred bridge and match this same measurement exactly on the other side.

The next stage was to determine the string positions on the bridge tie block where I would have to drill six holes. To do this I had to mark onto the guitar the measurements of the outside strings from the edge of the fingerboard as shown here on the right. These measurements were marked on the guitar and extended down with a long straight edge onto the correctly positioned bridge showing the location for these two outside strings. This measurement of 58mm was then divided by 5 to give the location of the six holes.

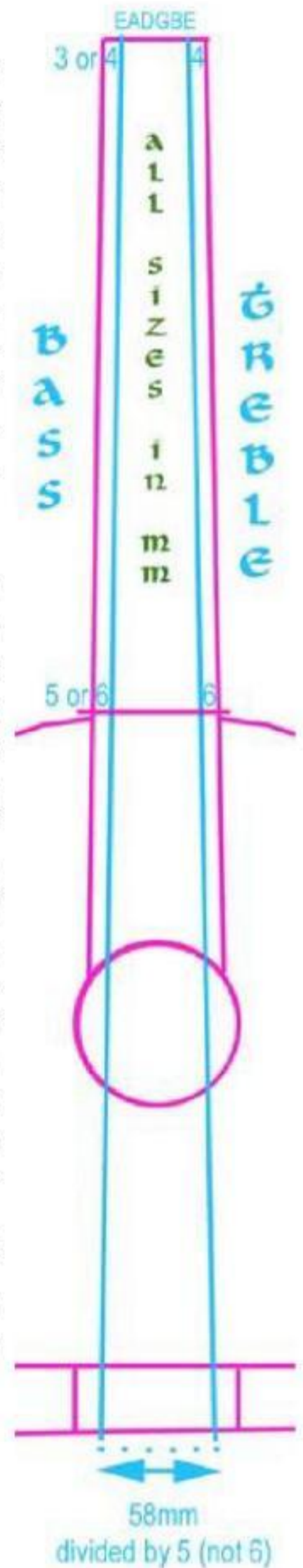

## Making Bridge 3



With the six string holes marked onto the bridge I then set up the pillar drill with a 2mm drill. With the bridge block protected by 2 cauls and clamped in the Nippy Vice and also with the bridge firmly seated down in the vice, I then marked on each hole to be drilled firstly with the bradawl. I set the small drill up in the chuck in such a way that the depth left showing was as far as it needed go into the wood. The depth to drill was as far as the central 'valley' part of the bridge where the strings come out and go up to the saddle. With this set up and with a long block of wood clamped on the pillar drill table I was then set to drill the six holes shifting the Nippy Vice along the long block for each hole to try to keep them all in alignment.



Here I made a mistake in cutting off the excess at the 'wings' of the bridge before routing the saddle and central valley slots. I cut the wood at the wings away with the razor gent saw followed by the band saw. I then filed the wings flat with a large flat file to get the height consistently 4mm high. Next I set up a 2.5 to 3mm router bit in the pillar drill and made a jig up that would allow me to run the bridge from one stop to the next to give me an exactly routed saddle slot. Usually on a classical guitar the saddle runs straight through the central raised area from end to end but Bill and Michael were saying they feel this weakens the bridge so it's better to contain the saddle more in the style of a steel string.



I set the pillar drill to rout into a depth that would leave 4mm of bridge underneath the saddle. I made sure that I was pushing the bridge in the direction of the cutting edge and after running it through I ran it back the way to take away any rough edges. This worked fine and so then I went on to rout the central channel for accessing the six string holes. This was needing to be routed down below the depth of the string holes which were at 4mm so it was thought that the central channel should go down to leave about 2 to 3mm. I did this fine. It took a good few runs routing just a few mm at a time gradually going down to the final depth.



When checked it seemed the saddle slot was maybe not deep enough so I set up again for the saddle slot putting the stops in place etc but I forgot to raise the depth of the router bit just a little so I took the saddle slot down to 2mm as well instead of 4mm so I may now need to glue a little strip of rosewood onto the

bottom of the saddle and shape it before fitting it into the slot. This is a possible solution anyway though I could also maybe just buy a bigger saddle.

## Making Bridge 4



With both slots routed I then began chiselling away the string channel in the centre using a long  $5/8$  paring chisel to round off the side going towards the saddle slot and squaring off the opposite side for the the string tie block. Useful here was a small needle file and some sandpaper wrapped around the small 6" rule. Every now and then I put a guitar string through the hole to see how the string might angle up towards the saddle. After getting to this stage I realised I will have to get the saddle onto the bridge next to better assess the angle the string takes in relation to the saddle edge. At the stage this area of the bridge is at just now it could always be altered on the guitar itself either when positioning the bridge or even possibly when the bridge has been glued on. Next I squared off the ends of the bridge wings using a flat file. After this I marked on the height of the four edges of the bridge wings where they meet the soundboard at the base of the curve. I used the marking gauge to mark on a height of 1mm to keep me right when filing the curve of the wings. On the newly flattened ends I drew in a curve in pencil again as a guide to keep me right while filing. I also drew a centre line down each wing to keep both sides consistent. I then filed away with the flat file gradually rounding down to the 1mm mark at the edges and trying to keep the centre lines intact so that I was not altering the height. Once I had it nearly there on both sides I had to also use some needle files and sanding sticks to very carefully work into corners around the central area to keep everything tidy. In the end I think it is still a little heavy so will need to thin the wings some more.

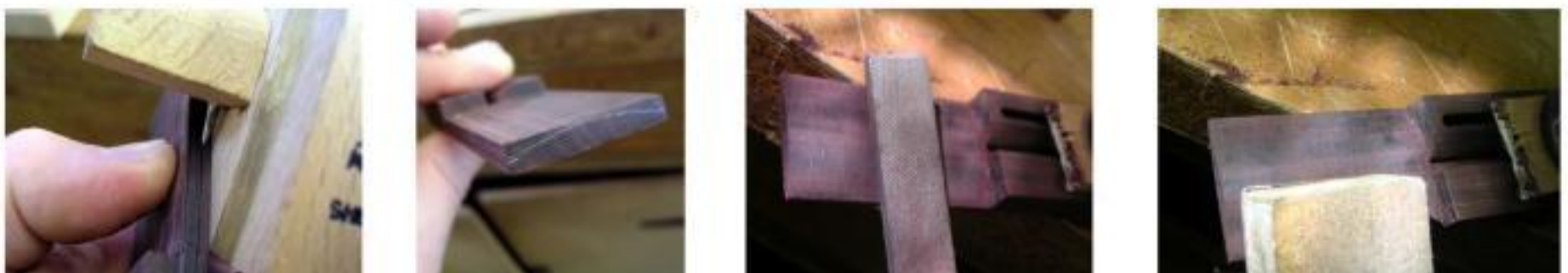

## *First attempt at String Tie-Block*



*Next I began making the string tie-block using veneers of red, white, black, white, a rosewood centre strip and then the same veneers the other way round on the other side. For the tie-block edges I used a corian (hard plastic) saddle cut into strips on the band saw. I titebonded the wood layers and superglued the plastic to the edges and after many attempts to find a solution made a small jig up (above & below) for sanding the tie-block to thickness. In the end I felt I had rushed the tie-block so decided to do another!*



## New inlay for Bridge Tie-Block

I had a think about the tie-block and thought I'd attempt to make one which matched the rosette flower motif. Having read a bit about making rosettes I had a rough idea of how to make mosaic tiles so went ahead and cut some veneers into strips about 1mm wide. These veneers were about 0.7mm thick so I estimated that this matched up (approximately) with the ratio of the individual pieces of the rosette (2 by 3). With enough strips cut, I then worked out the sequence according to the rosette and began gluing up 5 veneers at a time using titebond. When all 5 bunches of 5 were individually glued, I sanded both sides of each to remove any excess glue before going on to glue these bunches into the log from which the tiles will be cut. Once this was dry, I gave the whole thing another sand on each side again to get rid of any glue. I then worked out using the vernier caliper that I needed to cut 13 tiles to fit along the tie block, and this would allow for one flower on each string position and one inbetween and



one extra on either side of the outside strings. I pencilled in and marked the log to be divided into 14 and began cutting using the jewellers saw. The jewellers saw unfortunately gave a big slant on the cuts which I had to live with and hoped I could fix by sanding later. I tried a junior hacksaw but the cut was too rough and wide. Once all the

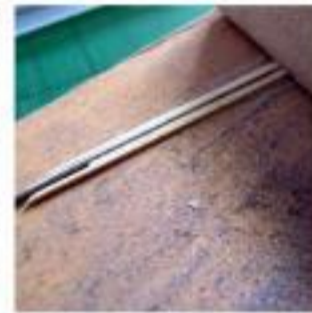

tiles were cut I positioned them on the bridge and then began to square one face of each on a sanding block. When positioning them I noticed that it looked quite good to turn every other block the other way showing the side pattern. So this meant



that there would be 7 flower designs inbetween the strings with a stripe under the string. Liked this and decided to glue them onto a piece of black veneer as a way of forming the inlay. I glued all the pieces with the squared face up the way trying to keep them all at the same level. When I got to the end I then had to use a flat file to square up the



opposite sides of the blocks I had turned to bring them all into alignment before gluing in the other black veneer to seal the tiles in place. With this done I then sanded the inlay flat on both sides with a sanding block with the piece held on a bigger sanding block which helped keep it flat and secure. I filled in both ends with 2 white and 2 black pieces of veneer to complete the design and then surrounded the whole inlay with 2 white along the length and 3 on the ends. This brings the tie block inlay end to end with the entire mid section of the bridge. Next stage will be gluing on the 2 pieces of plastic to strengthen the edges that the strings will wrap around.



## Finishing Second Tie-Block



At this stage I thinned down the area of the bridge where the tie-block would be glued with the block plane. After a few attempts I made a jig from a piece of ply that I clamped to the bench to enclose all sides and act as a stop for holding the bridge while planing. Took it down to a height that would mean when the tie-block was glued on it would bring the area back level with the saddle slot area. I also kept a check with a straight edge that I was keeping this area level. After planing I sanded it a little to tidy it up.



Next I glued on the corian sides to the inlay with superglue then sanded the whole piece flush using the same jig as



used for the first tie-block. Once ready I double checked the fit and then superglued the whole tie block onto the bridge and clamped together. Next I sanded the top a little more and then rounded the edges where the strings



will wrap over to prevent the edges cutting into the strings. To finish off I applied a thin coat of polish to the inlay.



In the end I felt that when I held the bridge up to the guitar the large amount of white from both the corian edging and the white of the inlay, maybe was making it stand out too much above all else on the guitar so after much thought and consideration, I just decided to start again.!





### *Third and final Tie-Block!*



*Decided it was the corian I didn't like so much so trimmed some of the leftover ebony from the fingerboard and made two edges. The nice inlay I made on previous page got a little damaged when pulling it off the bridge again so I decided to make another which is always good practice and it didn't seem to take as long last time around. Also because this time the tie-block edges were to be made from wood I was able to use solely Titebond to attach all pieces together and whole tie-block to bridge. After gluing the tie-block in place, I tested to see if the strings would sit correctly over the design using some ordinary string (below right).*



## Preparing to Glue Bridge

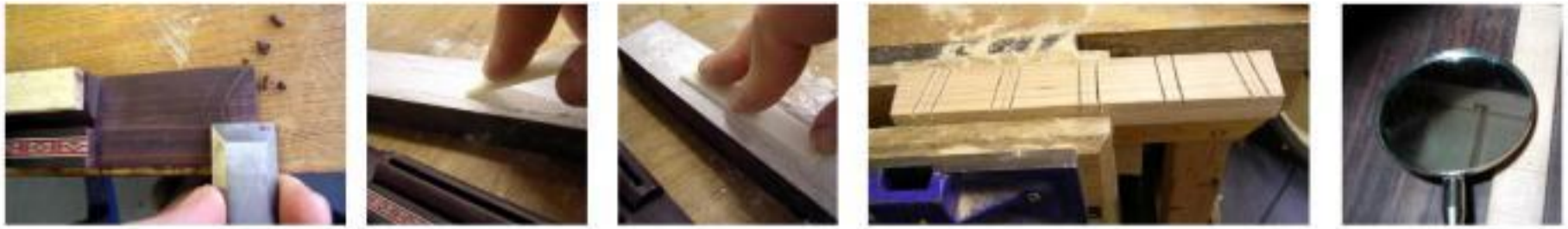

Next stage was to chamfer the 2 ends of the bridge and I did this as shown in the photo on the left using a 5/8 inch chisel. From above, the distance I chiseled in was about approx 12mm. I made sure to leave about 1mm at the base of the chamfer to match with the other edges of the bridge. I also prepared the corian saddle blank by thinning it to 3mm on a sanding block until fitting the slot and then taking the edges off on the bandsaw and finally rounding the edges over on the sanding block to fit the slot snugly. In preparation for gluing the bridge I made a clamping caul from a piece of beech to protect the fan braces on the inside of the guitar. I used the guitar body template to show me where the braces are positioned underneath where the bridge was to be glued (see 2 images above right). After this I rounded off the front edge of the bridge where the saddle will sit in place but made sure not to round up and over the saddle slot to make sure that it remained completely level where the saddle is to be held. Once this was done I sanded the whole bridge very lightly with 1200 grit paper. One mistake I had to correct here was that the bridge had a different length up one side from the outside string hole than the other so I had to trim some off one side to make sure the bridge was symmetrical which will be important when fitting. Once I had done this I had a bit of correcting to do on the chamfered ends once more. I wasn't too happy with the effect of the 1200 paper on the chamfers as it seemed to have rounded the sharpness of the angle so I re-done these using a harder grade sandpaper and it seemed to sharpen them again. With the bridge almost complete I then gave it about 3 very light coats of jaxa spray varnish over the space of a few hours to build up a nice matt coat. After this I gave certain rough areas some more attention with the 1200 grit paper and then just one final light coat of the jaxa spray. Next I drew on a centre line at several points on the fingerboard and also on the bridge at the saddle slot so that I could line the bridge up using the metre ruler. I set the bridge so that the 652mm scale length mark was just after the first third of the 3mm slot. Once I had the bridge positioned for scale



length, I then checked by measuring from the edges of the fingerboard at the nut to each of the corners of the bridge on both sides. After a good few checks I managed to get the two sides matching and I then re-checked the scale length again and also that the centre line was still running up the fingerboard from the mark at the saddle position.

## Gluing on Bridge

Once this was checked over I was then given the go-ahead to drill in the two 1.5mm drill bits at either end of the saddle slot which will keep the bridge in position while gluing in place (positioning pins). Some guitar makers use small dowels instead of drill bits for this job. Once done I then re-checked just to make sure it was sitting in the correct position to be glued and it seemed to be fine.



Next was to scrape away the polished area of the soundboard where the bridge was to be glued so I began by scalpelling the position of the bridge onto the soundboard by tracing around it very carefully. I made sure only to scalpel along the edges and stopped just short of the corners while also making sure to cut with the point going slightly in and under the

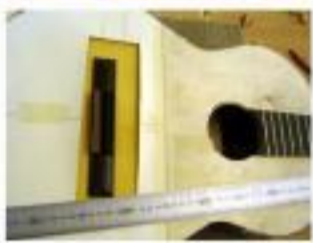

bridge to avoid any gaps in the polish around the bridge once it has been glued. A mistake I think I made here was to dig a bit too deep with the scalpel. Realised this when cutting with the grain at the ends, where the cut seemed way deeper than the polish. Will have to see what happens when the strings go on. I then carefully scalpelled into the corners of the panel to be scraped away using a steel rule as a guide instead of the actual bridge.



After this I put a burr on the 5/8 inch chisel and used it as a scraper to scrape away the polish contained within the bridge area. Initially I thought I had enough polish scraped off but was told it had to be scraped back completely to the wood and after a while I realised



this as the white of the spruce was gradually revealed again. After a couple of times of putting a burr on the chisel, I eventually managed to scrape the area back fully enough to move onto the gluing stage.

With the clamping caul doublesided in place underneath I set about re-positioning the bridge pin drill bits and set up the 3 clamps ready to go. I

applied some titebond to the bottom of the bridge and spread it evenly around and then slipped the whole bridge over the drill bits and down onto the scraped away area of the soundboard. I put the 2 curved cauls I made for the bridge wings on and then put the first long cam clamp in position on one wing and tightened it up. Next I did the opposite wing with another caul and finally the middle to hold down the actual saddle and tie block area. I cleaned up the glue squeeze out using a bit of thin ply and also a stiff brush and some water.

## Fret Stoning & Profiling Process

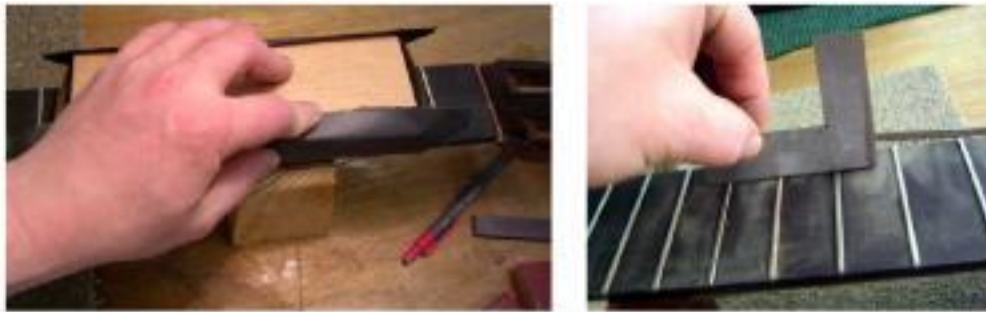

To begin with I wrapped a piece of 400 grit wet/dry sandpaper around the beech fret stoning block I had made. I sanded along the frets from one end of the fingerboard to the other several times and every so often checked the levelness of the frets using the small engineers square.

Because there is a slight curve lengthways in the fingerboard from nut to soundhole all the frets will never be fully level from one end to the other anyway. Instead it is important that the levelness from one fret to the next is continuous from one fret to the next all along the length of the fingerboard curve and this is why the small engineers square is

used rather than a long straight edge. Here it was important to check all along width ways on each fret to make

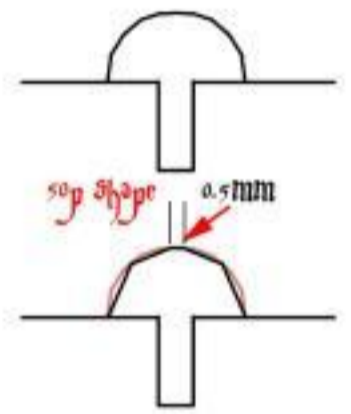

sure that all areas of each fret are level with the ones on either side. Checked all along fingerboard while also sanding back inbetween from time to time to correct frets not yet level.

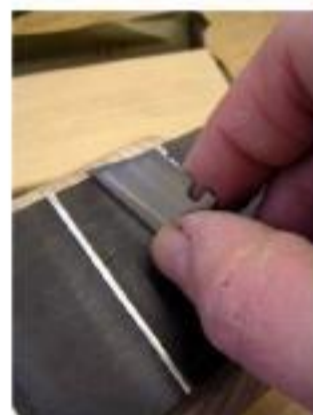

Once all the frets were levelled with sandpaper, I drew a red line on top of each with a permanent marker to make the next job of filing (profiling) the frets a bit more easy to follow. With the tops all marked in red, I then had to take the triangular file with blind edges and file both sides of each fret as shown in the diagram to

make it look almost like a fifty pence piece but with a flat of 0.5mm on top (fret crown) when viewed from the side. With the red pen it was easier to see when I had reached the 0.5mm flat area on the top. Once I had done this to all 19 frets, It was now time to round off the fifty pence shaped rough edges using the beech fret burnisher made earlier. With a piece of 400 grit I sanded back and forth on each fret to soften the profile of each fret. This was followed by some steel wool to bring the frets back to a fine shine. Once this was done I then had to use a fresh stanley blade (had to use about 5) as a scraper to scrape away any marks on the fingerboard and also to freshen up its appearance a bit more. The dust created from scraping also filled up any gaps left underneath frets.



## Widening Holes for Rollers and fitting Machine Heads.



*Found out when fitting the machine heads that should have initially made a 10.5mm roller hole as they need a little room to move. Next time.*

*Tried a drill with sandpaper double sided to it, to widen the holes but it was too sore on hands. I also tried a rolled up piece of sandpaper but this was also bit painful to turn. Thought up a dowel with a notch sawed into top*

*with a long thin piece of sandpaper rolled round top to sand hole and was able to then gradually lengthen piece of sandpaper to make hole eventually wider.*

*This worked very well though it was a slow slow process and it still was a bit sore on the fingers though not as bad as the other 2 methods. Gradually I got the machine heads to fit quite well that they were not sticking. A great suggestion by Rab was to put dry soap on the rollers to make them turn easier when tuning.*

*With the machine heads fitting quite good now I then took a bradawl and carefully marked on where each of the 8 screws would go. Once I marked them, I then used a very fine 1mm drill bit to drill in a pilot hole for each screw. I used some masking tape around the drill bit to stop myself drilling too deep.*

*Once I had done this I then simply screwed in the screws tight but not overly tight as brass screws can come apart sometimes in wood if tightened too much.*



*2 views of Ribs while fitting machine heads*



## Making Nut

To begin with I sanded the Corian Nut on a sanding block, checking all the time until I had managed to get it to the right thickness for fitting the 6mm nut slot. Important here were the vernier calipers to keep track of thickness all along the length.



Once I had it fitting I chiseled out the nut slot on the guitar very very lightly to scrape away any glue or dust that might stop the nut from being seated properly. I also did the same thing using a flat file with the blind edge down.

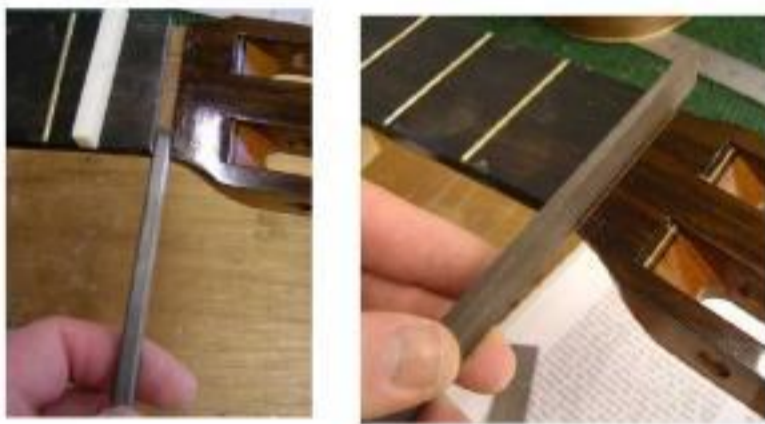

Next I sanded the bottom of the nut on the sanding block and used the engineers square to make sure it was completely square all the way along the bottom and square with the first side that touches the fingerboard.

itself.

With a pencil cut in half lengthways and sitting on the first few frets I marked a pencil line onto the nut which was just slightly higher than the first fret. Another method was to put in something the same height as a fret such as a needle file and then trace a line from this onto the nut with a sharp pencil. Either method works fine. This pencil line is to mark where the bottom of each string slot will be on the nut (just slightly higher than the 1st fret).



With the line drawn on I then set about rounding off the opposite edge where the strings will angle down over the nut down towards the rollers. The mistake I made here was to sand the nut back too close to the pencil line so in the end I didn't have as much material left for cutting the slots into.

# Nut and Saddle Measurements Together

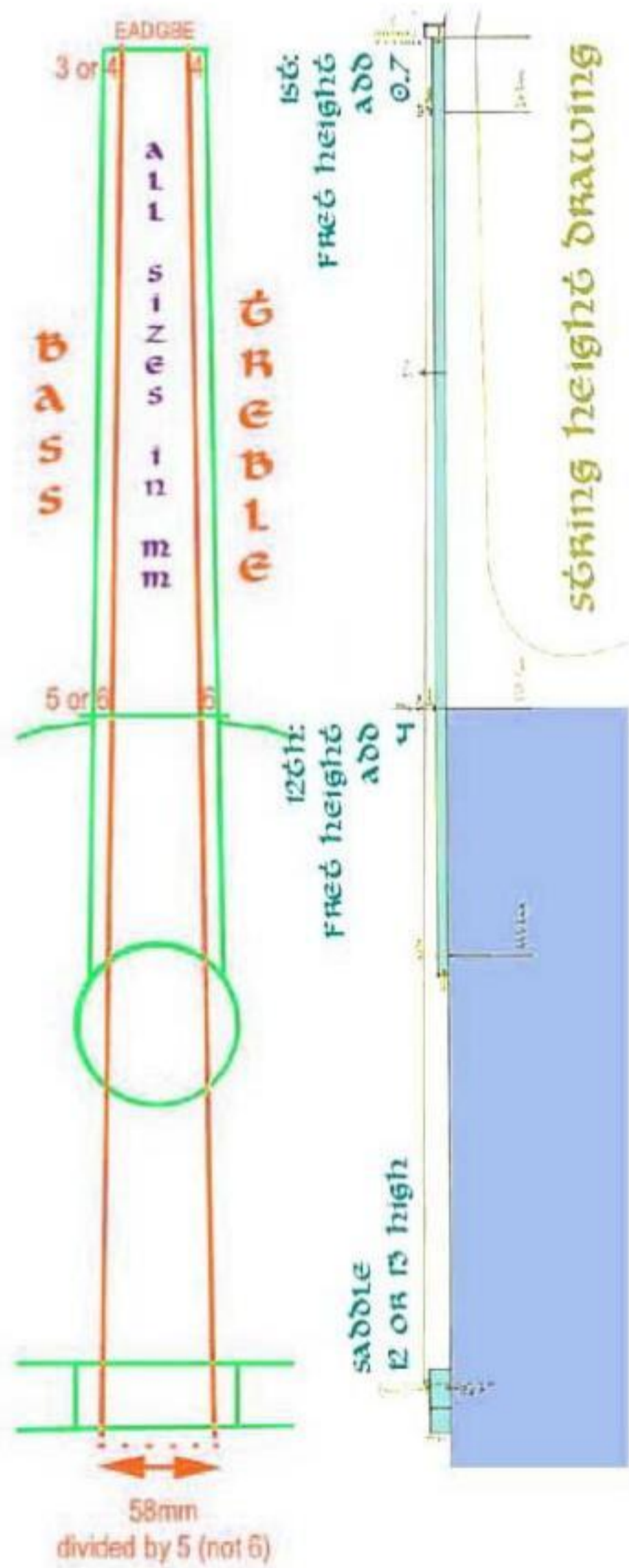



## Setting up Nut

With the saddle in place sitting at its unchanged height of about 14mm, and with the unslotted nut in place, I firstly began by putting the high and low E strings onto the guitar and tightening



them up though not fully. With the strings resting on the top of the nut I was then able to see how far from the edge of the fingerboard each string was sitting. On the classical the guitarist expects a bit more than on a steel string so I decided to go for about 4.5mm on either side at the nut end. I marked on in pencil then used the needle file to make a preliminary notch to locate the two E strings.

The next stage was to divide the distance between the 2 outer strings by five { $43.5\text{mm} \div 5 = 8.7\text{mm}$ }. Once this was done I marked the measurements onto the nut, measuring and marking each 8.7mm with a small ruler. Bill said an easier method is to make a piece of card that's 8.7mm and then draw the marks on using that instead. Either way is fine. Once the nut was divided and marked in pencil I then used the needle file again to make initial notches to locate all the strings.

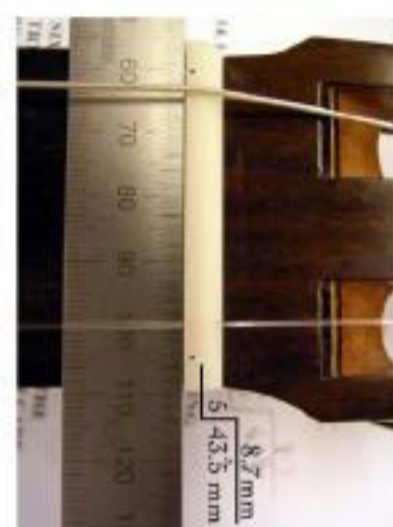

With all the strings now partially in place on the nut I was able to tighten the strings more fully without them slipping out of position. With the strings tightened I then had to take each string out of its notch one by one and deepen each groove until it met up with the pencil line drawn onto the nut. To double check the 'Action' at the



nut I held down each string tight to the 2nd fret and looked to make sure that there was still a little tiny gap inbetween the string and the 1st fret. Also important to take note of here is that each string has a slightly different diameter and each one needs to rest into a slot half of that diameter. If the slot is too big then the string may be loose and not resonate from the exact edge of the nut, which will put the string out of tune (intonation). With all strings sitting in place at the right height I had to then make the string notches angle more gently down through the nut towards the string rollers in such a way as not to damage the integrity of the edge of the nut where the strings rest.



## *Last Few days of Polishing*



*Tuesday June 6th: Lightly sanded guitar back the previous day with 400 grade to de-nib. Today was the last day of polishing the guitar before the concert as it needs a full day inbetween to dry - Applied one or two coats around whole guitar with a 30% polish / 70% meths mix. Mostly the aim of today was to fill in the neck with a bit more polish as it was still feeling a bit rough for playing.*



*A problem I had here was that the bridge was now glued on and so it was difficult to use the rubber to move around the bridge. I had covered the bridge in masking tape to protect it but the polish going on around this area ended up looking a bit rough.*

*Again a very light 1200 grit sanding back with water to de-nib again.*

*Having already applied a few coats focused on the neck area before I sanded, I then moved onto spiriting off with the rubber blotted almost dry of polish, then soaked in meths and blotted almost dry again. This method now seemed to be bringing the rough areas back to a gloss finish so I tried to go around the whole guitar a few times this way until I felt that the back and sides were looking good enough. The top I did another twice maybe just to try to smooth out some of the smear marks that were there.*

*Finally I focused on the neck area and tried to work with the spirit rubber to smooth it and get it a bit glossier, working right the way along the ebony fingerboard edges.*

*The polishing stage could probably do with going on for another couple of weeks but think it is good enough considering the limited time and it should do ok for the concert. Tomorrow will go on hopefully to do a bit of burnishing of the polished surface and also oiling the bridge and fingerboard.*

## Burnishing & Finishing

With the guitar now looking quite polished I used some 1200 grit wet and dry with some soapy water and very very lightly de-nibbed the whole surface. Once this was done I gave the guitar a clean up with the tack rag and then applied some burnishing cream to a half a yellow duster and began rubbing into the polished surface of the guitar. With the other half of the duster I cleaned off and buffed up the surface to a fine gloss finish. I did this a good few times over the whole guitar.

A mistake I made here was that on the back I managed to rub off all the polish on the heel cap so it ended up matt. At first I didn't realise this and was trying in vain to get it back to being glossy. In the end I had to paint on some neat polish that had been left to evaporate a bit. This filled in the area a bit - not great but good enough for the concert next day.



The day or two after the concert I done a bit more work with a meths soaked and blotted almost dry rubber trying to finalise the finish for the show at the Trades Hall. This day the polished surface of the guitar really started to look a lot better and the heel cap mistake finally was sorted out again good as new.



The following day I did no more work with the rubber and just did a bit more burnishing and one final tip from Bill before presenting the instrument was to paint a tiny bit of White Oil with a fine brush along the edge of the bridge / body join to disguise any marks made by joining or burnishing. Also any other areas such as along the side of fingerboard on body. This was now the guitar completely finished and ready for the Trades Hall.



## *Oiling Bridge and Fingerboard / Fine Tuning String Height*



*The bridge was oiled with Tru Oil once it had been attached to the fully polished surface of the guitar soundboard. This was repeated about three times or so. When burnishing the top with the burnishing cream and duster I tried to burnish the bridge too, as it seemed to take away some of the marks which I had not noticed, which may have just been from gluing.*

*Just before the guitar was strung up properly I oiled the fingerboard with Tru Oil. This seemed to darken down the fingerboard nicely and also seal it a little bit too.*

*I also made a second Nut and Saddle set from Buffalo Bone as I thought the first corian nut slots were a bit rough. Followed same process but left nut height a bit higher so that strings would sit into a deeper groove rather than strings being left to almost float above nut.*

*Height at Saddle must allow string clearance from top of fret at 12th to be:*

*4mm at 6th string (Bass E string)  
3mm at 1st (Treble E string)*

*This was achieved by making the saddle slope down (see above photo) from bass to treble to give 1st string a 1mm lower action. Saddle honed down along the block plane which was clamped upside down in the vice - continually checked saddle with a straight edge.*

*ALL strings at nut ~ 0.7mm from top edge of 2nd fret to underside of string.*

*The strings at the nut sit into a groove, the very bottom most edge of which is just a fraction of a millimetre higher than the height of the first fret.*

*The eventual Saddle Height for this guitar was 12mm on the bass side and 11mm on the treble.*

*Two Labels*



## *Finished Guitar Details*



*Playing Finished Guitar!*















## *Steel String Design*

## *Initial design ideas*

## *Design brief / customer requirements*

*The requirements are for a large body steel string concert guitar, similar to a Martin OM model but with a slightly higher waist with a more rounded overall appearance. The guitar will be used mostly for fingerstyle but should also allow for the use of barre chords. I have chosen a body shape similar to a guitar by the luthier Andy Manson as feel this is close to an OM guitar but is about one inch longer at the end block which gives the appearance of a slightly higher waist, and brings the soundhole closer to the centre of the guitarist's body while playing.*

*The headstock is to be slotted but in a classical style with a classical style top of headstock motif rather than the traditional flat ended steel string headstock.*

*The binding and purfling is to incorporate some kind of rope / herringbone design with a natural look with maybe only a hint of colour. A back centre strip using matching herringbone is required by the customer, either a single middle piece or a double if making a 3 piece back.*

*For the rosette a central herringbone with a couple of veneer lines either side keeping the guitar soundhole looking fairly traditional for a steel string.*

*The fingerboard width at the nut is to be somewhere inbetween a typical steel string and a typical classical at around 47 to 48mm. There should be a slight camber to the fingerboard to ease playing styles using barre chords.*

*The guitar would preferably have a durable enough finish to be used for transporting around venues for live work yet also have a clear enough tone that it could be used for recording work.*

*The soundboard and back bracing is to be as an OM.*

*Overall as regards appearance, the guitar should be a blend of elements of Spanish, North African and Indian design to hint at some of the origins of the guitar, yet also have some design features which are traditionally scottish to reflect the culture in which it is being made.*

*Finally, most importantly the guitar should have a warm rich sound with good clear bass , mid-range and treble tones which are also equally loud up and down the fingerboard.*

*Final body shape*

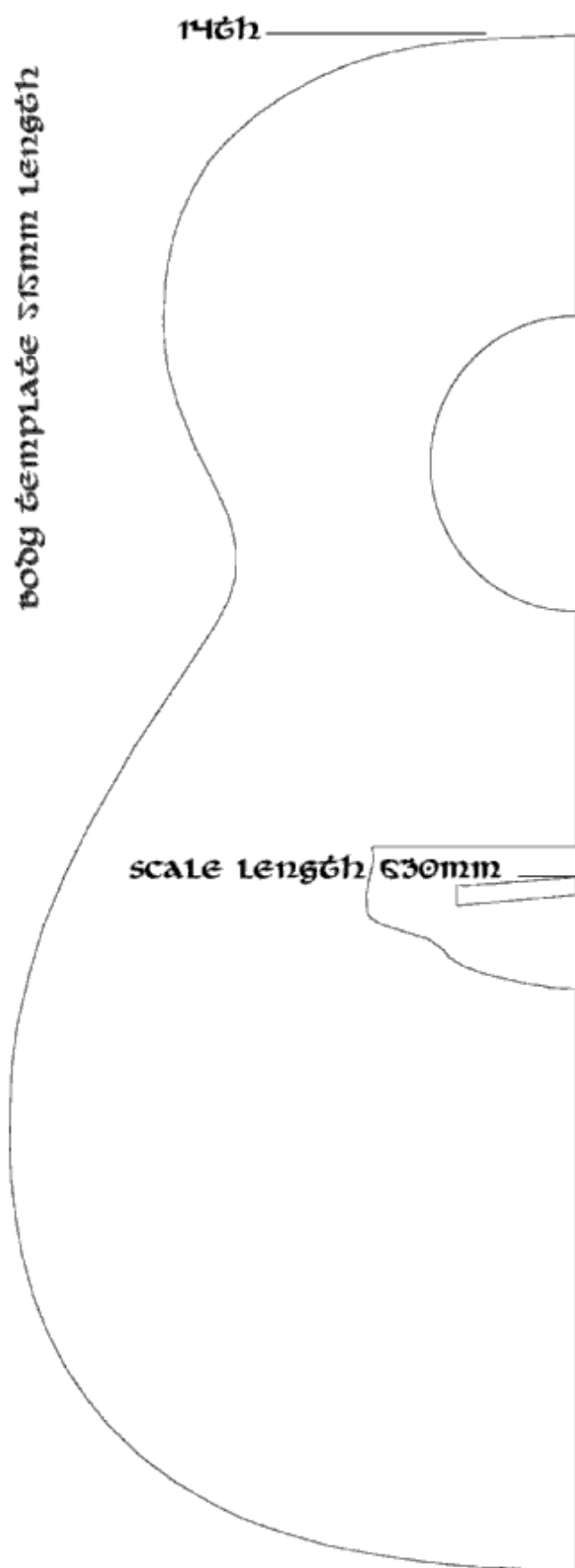

Some line drawings from Islamic exhibition in Edinburgh

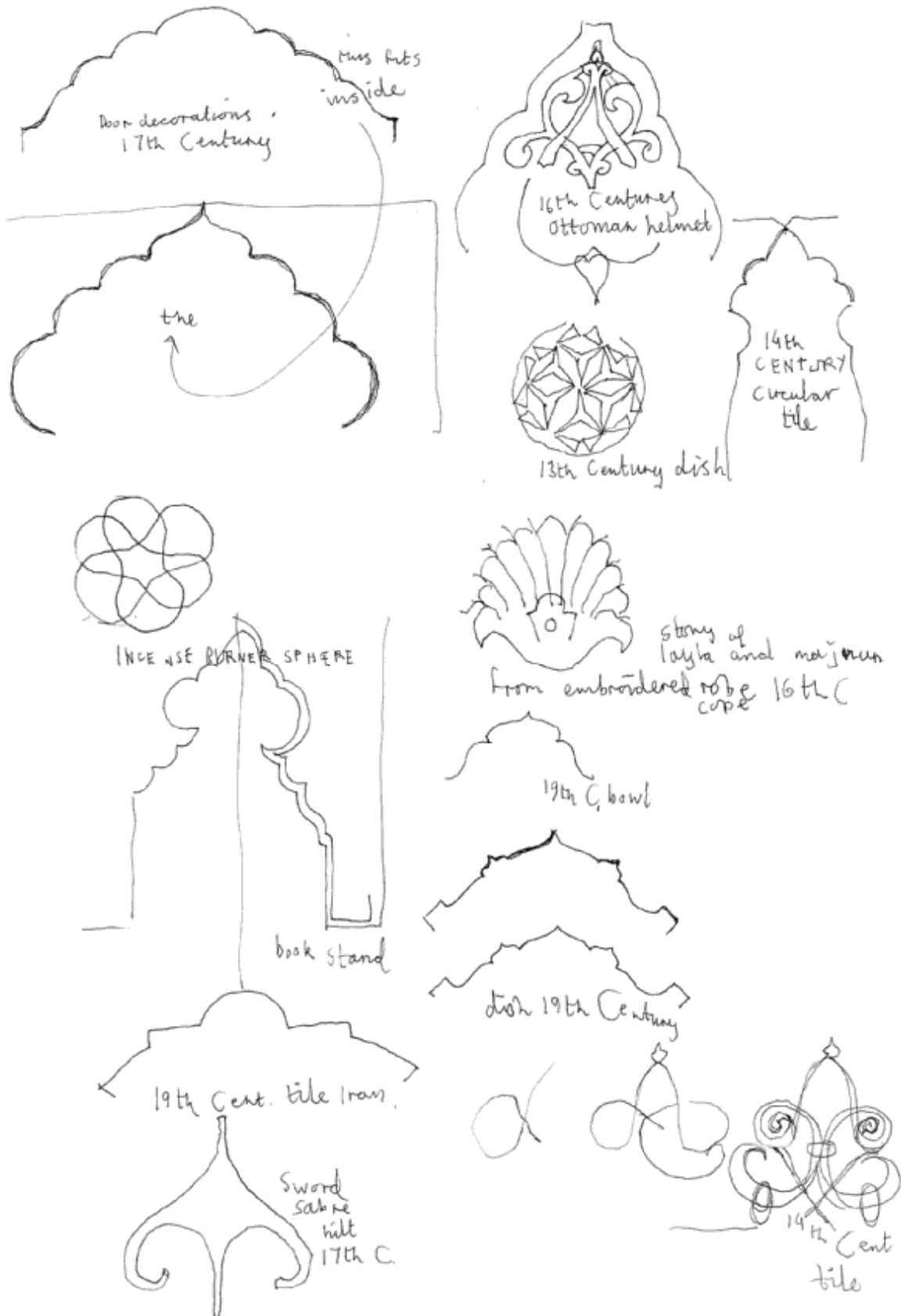



# Headstock sketches

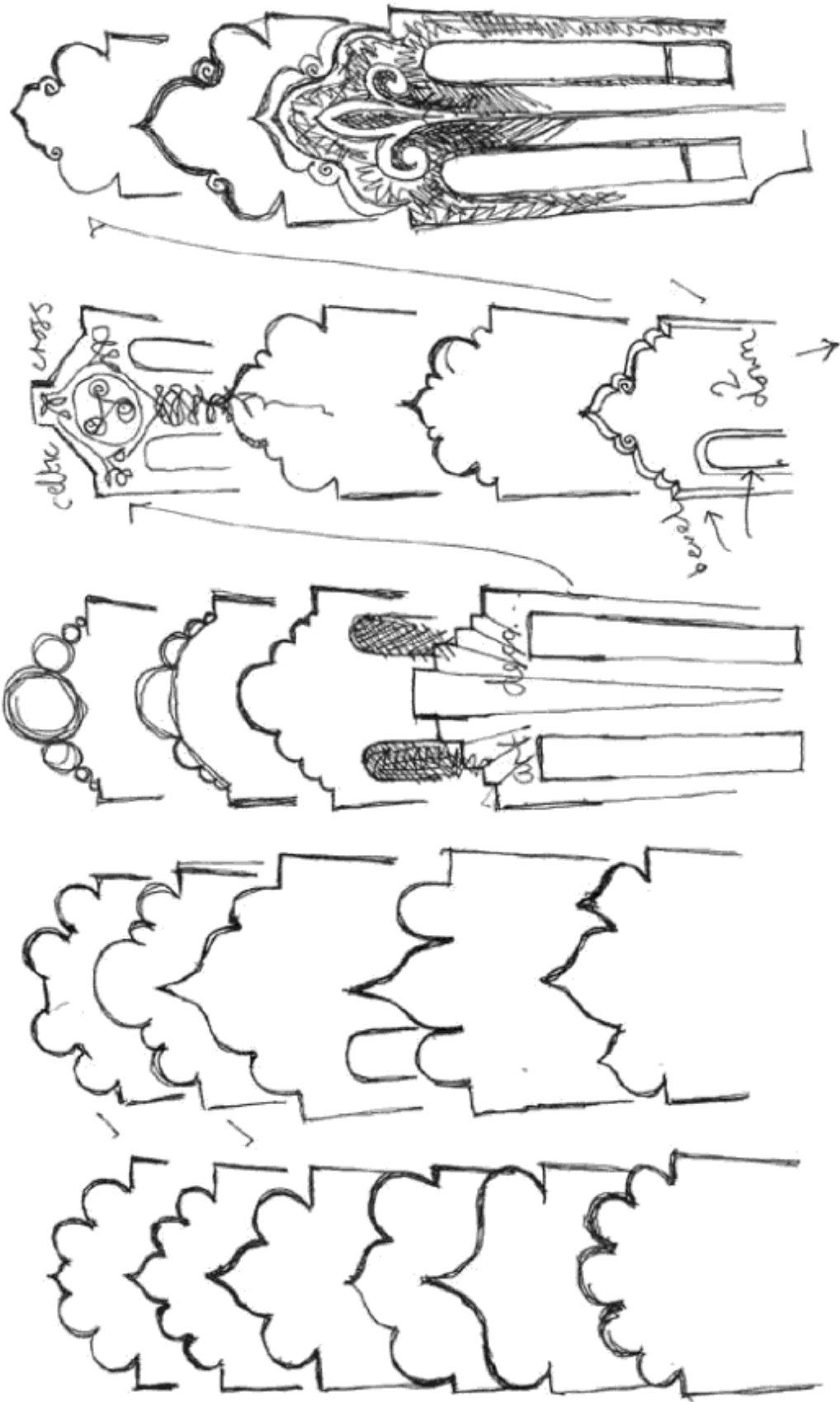

# Purfling ideas

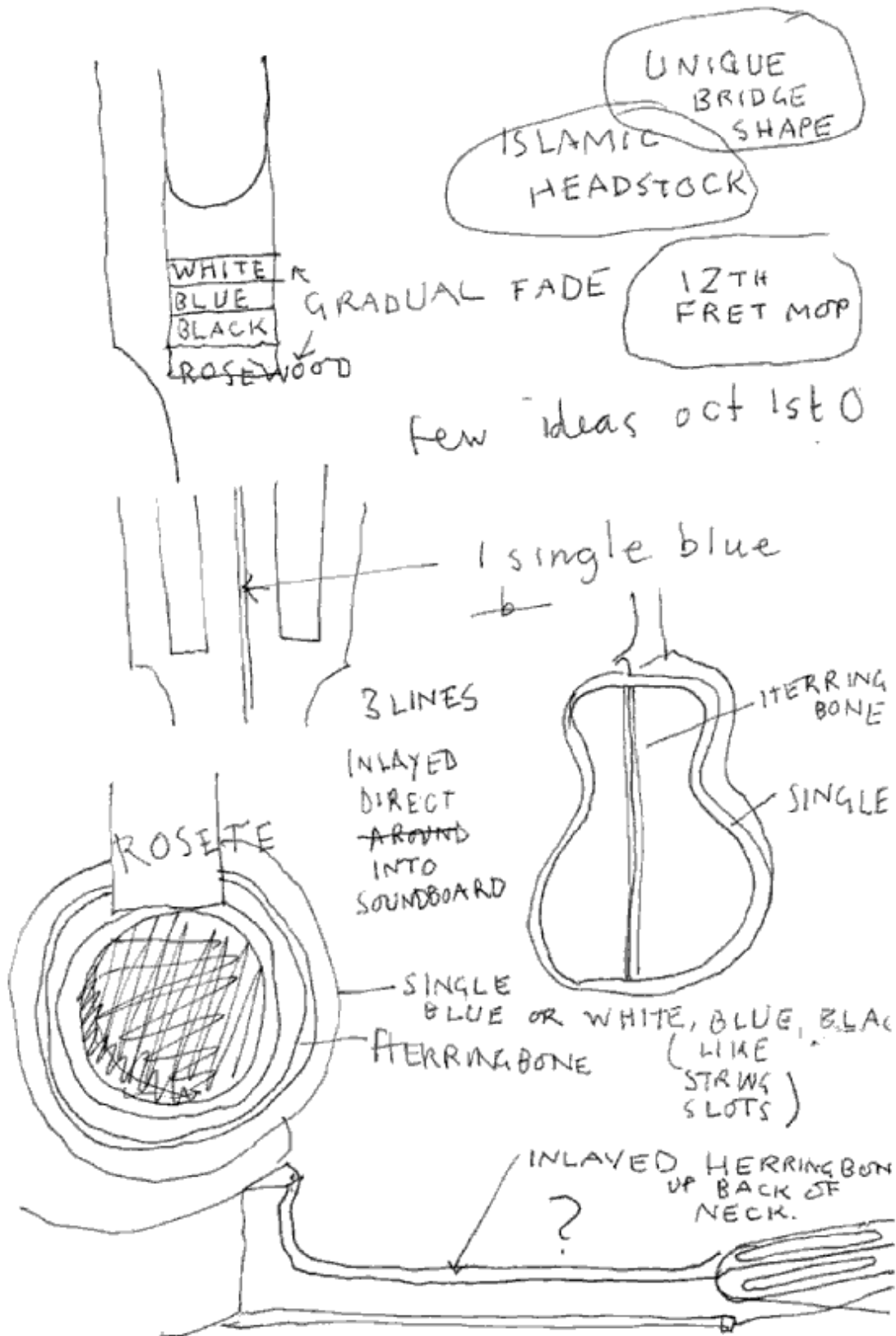

Near final ideas for bridge and headstock

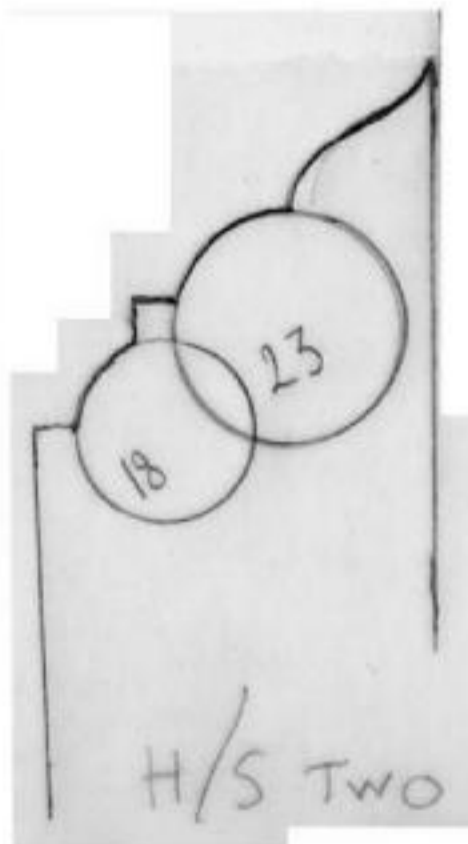
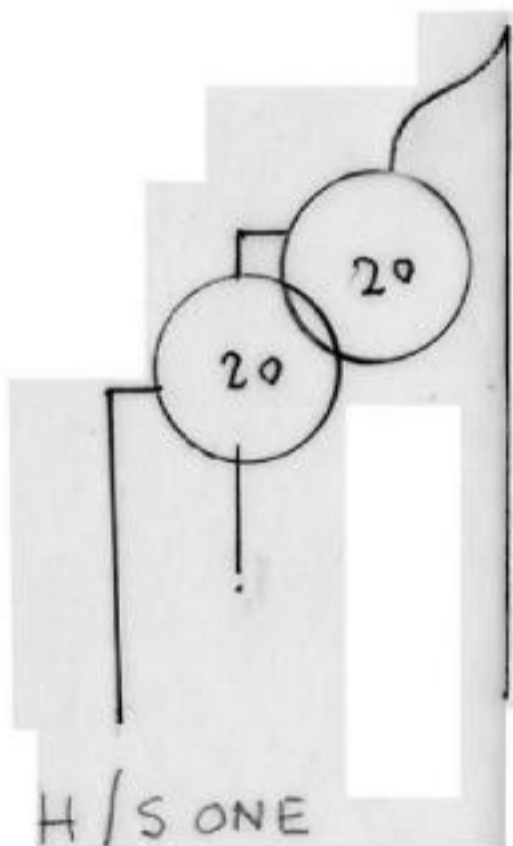
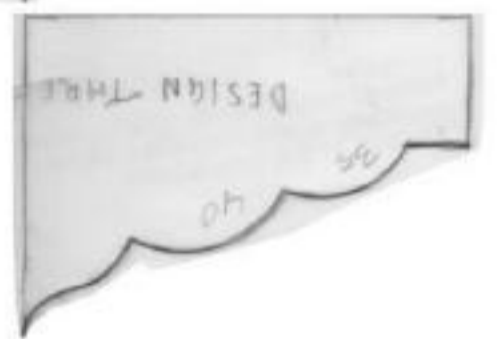
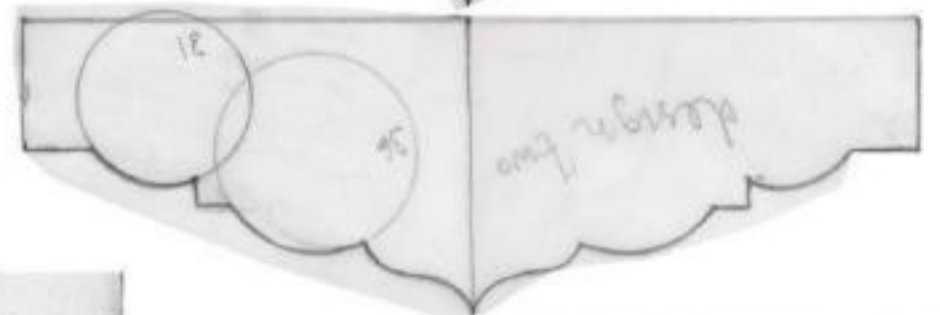
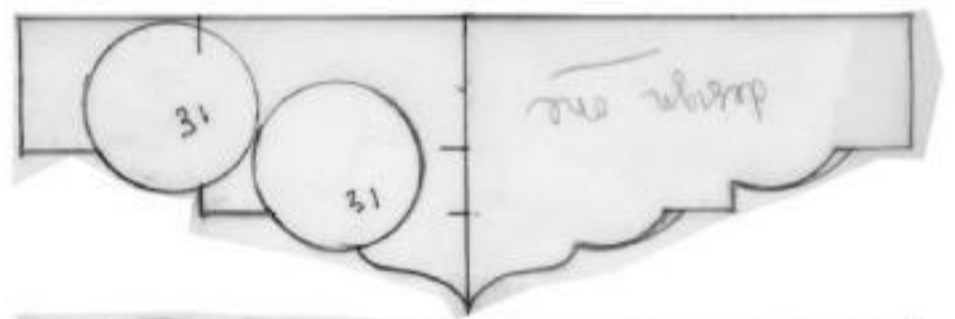
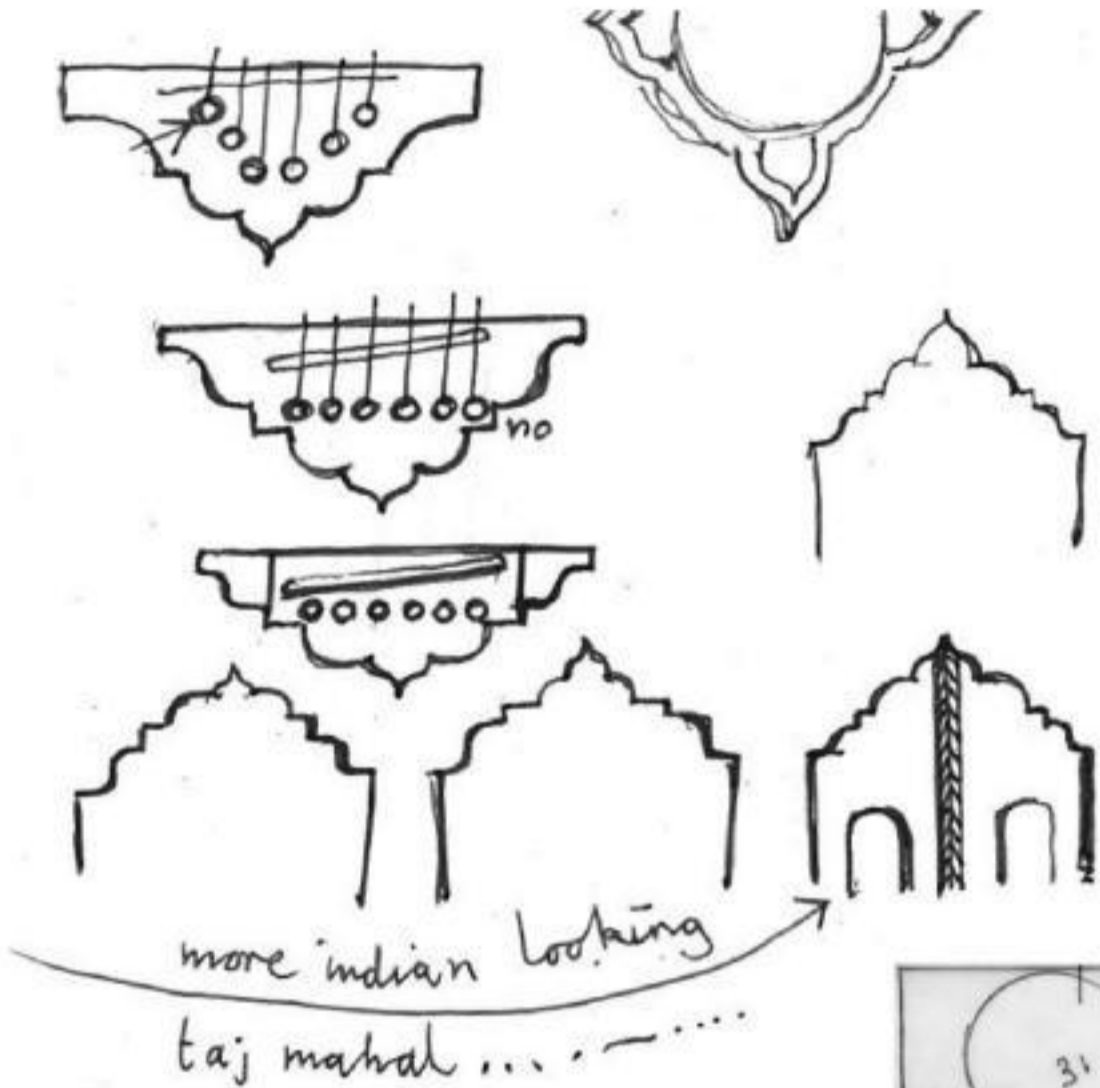

*Herringbone and ladder ideas*

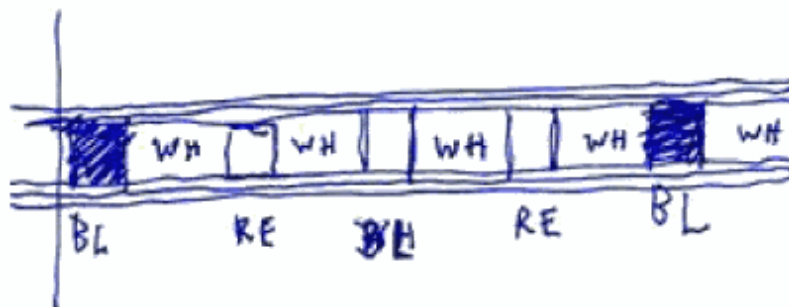
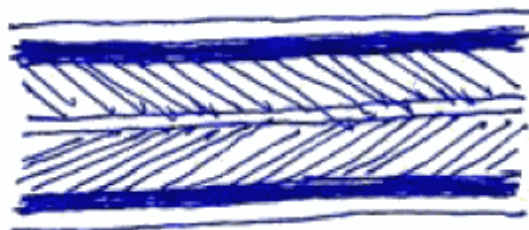
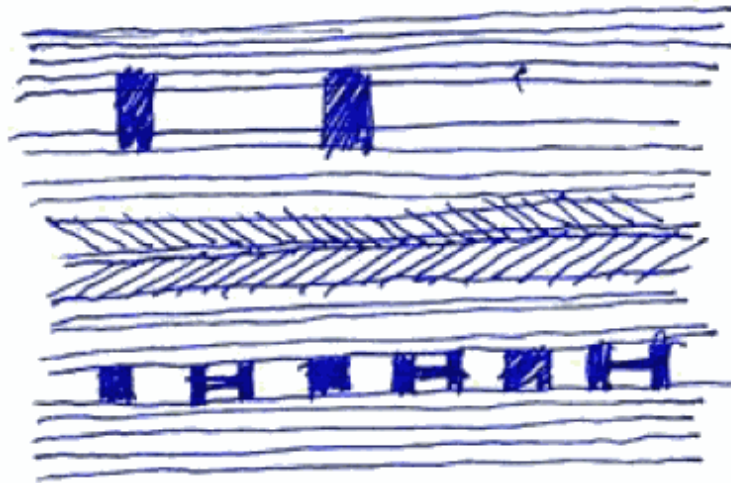

*Rough sketches for end graft*

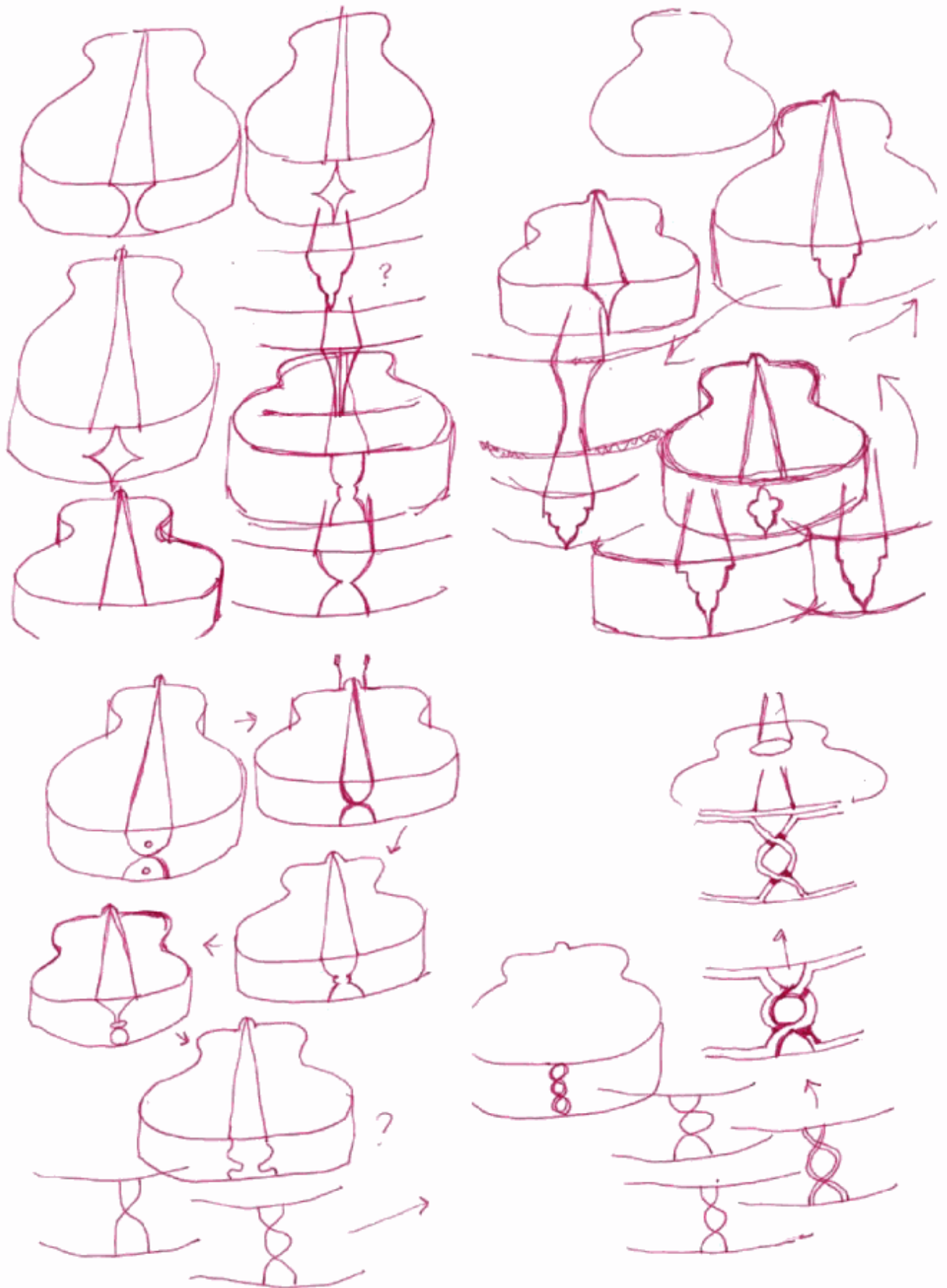

## *Expected instrument specifications before starting plan*

### Neck and Headstock:

Scale Length	630mm
Number of frets clear of the body	14 frets
Number frets in total	20
Width of neck at nut	48mm for fingerstyle
Width of neck at 12th fret	58mm
Thickness of neck at heel	24mm
Thickness of neck at heel without fretboard	19mm
Thickness of neck at nut	22mm
Thickness of neck at nut without fretboard	17mm as truss rod is at 13mm
Length of headstock	185mm
Machinehead spacings	slotted so 35mm apart

### Body:

Length of body	515mm
Depth of body at	
top	91mm
Bottom	105mm
Waist	97mm
Width of body	
Upper bout	280mm
Lower bout	380mm
Waist	230mm
Soundhole diameter	98mm
String height at bridge	13mm

Detail from first draft plan

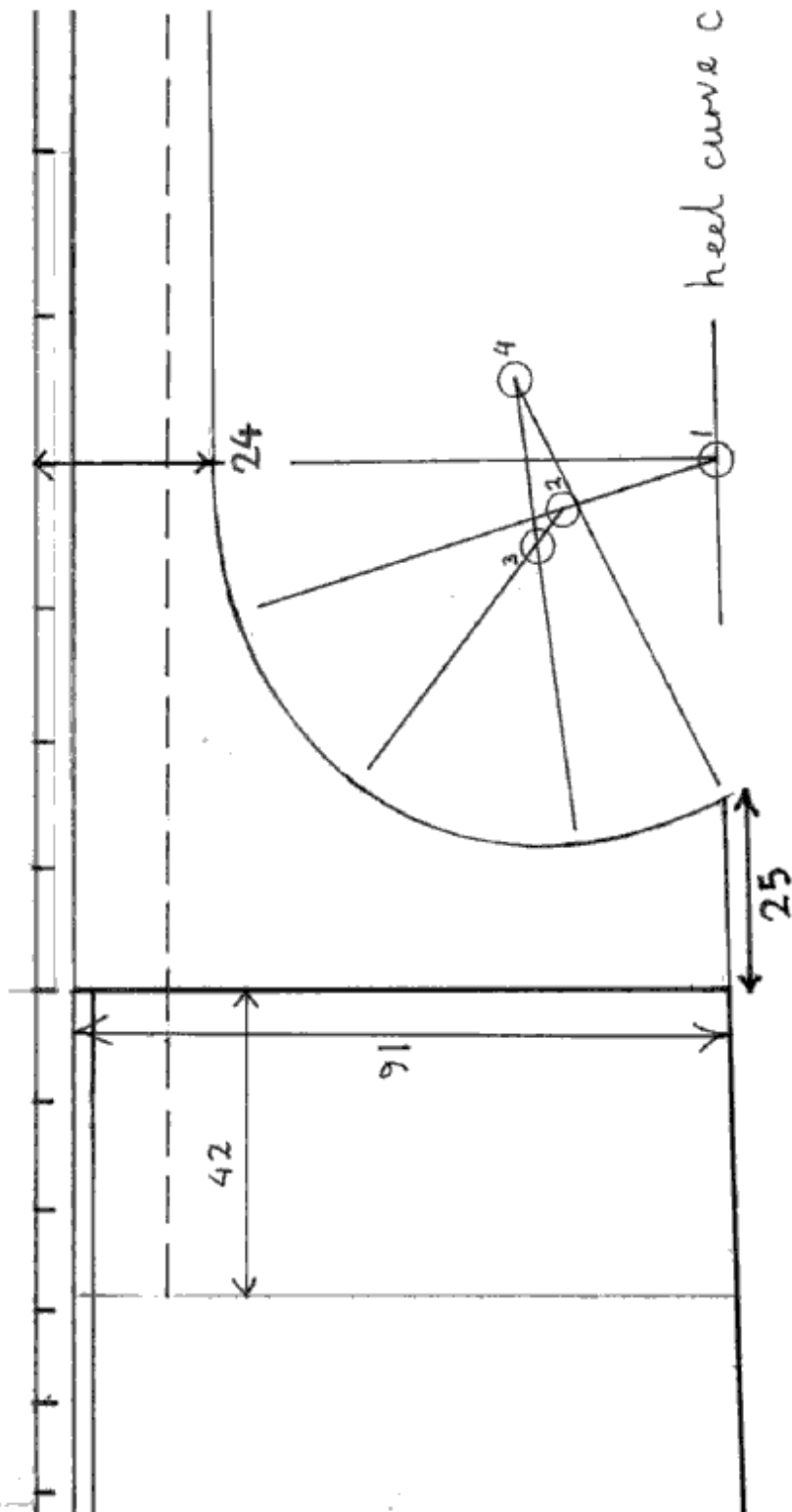

*This was a nice detail from the first plan I drew up. This first plan had a lot of mistakes but was a good exercise in terms of working out the layout.*

# Complete plan 1

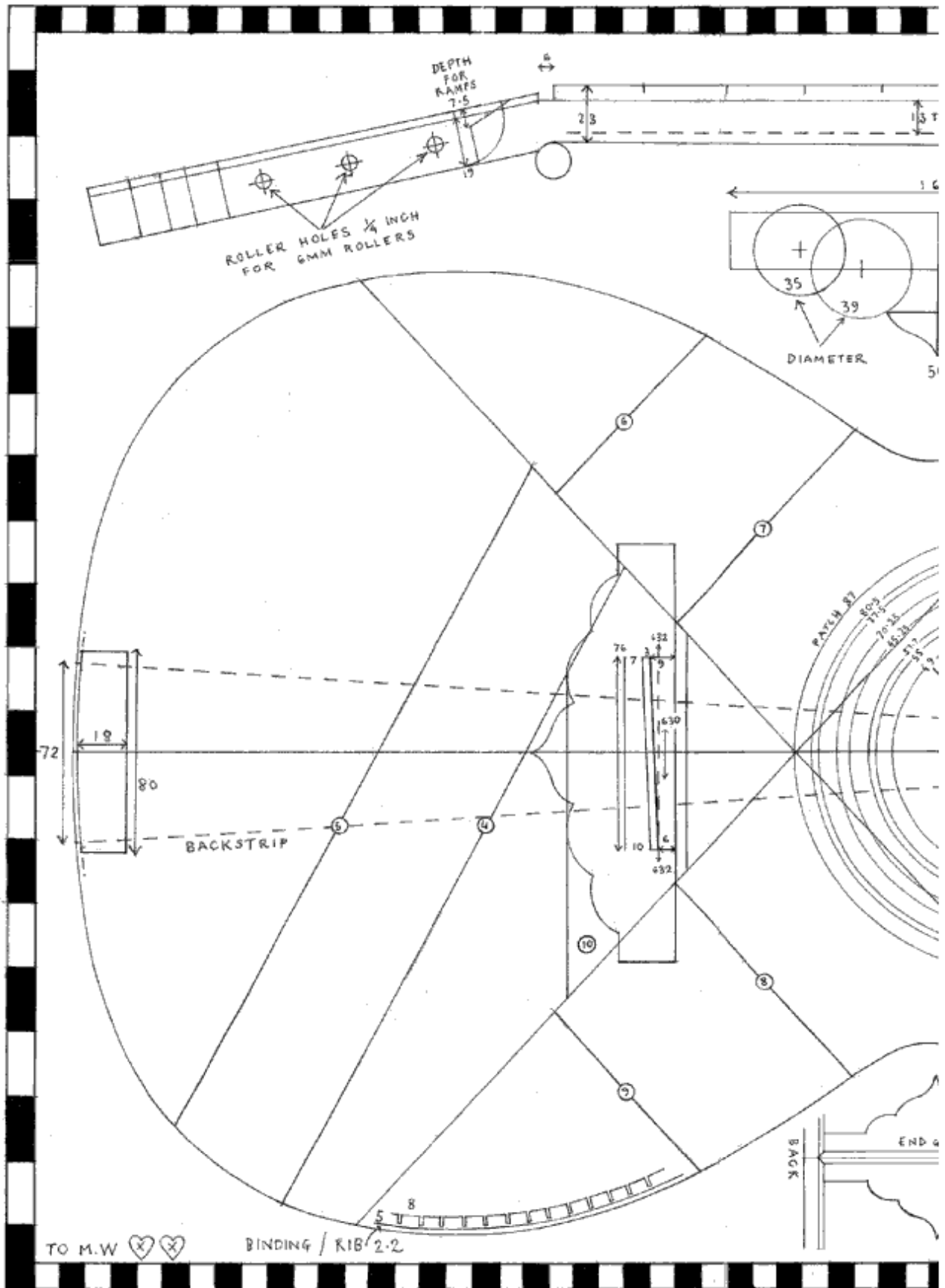



# Complete plan 2

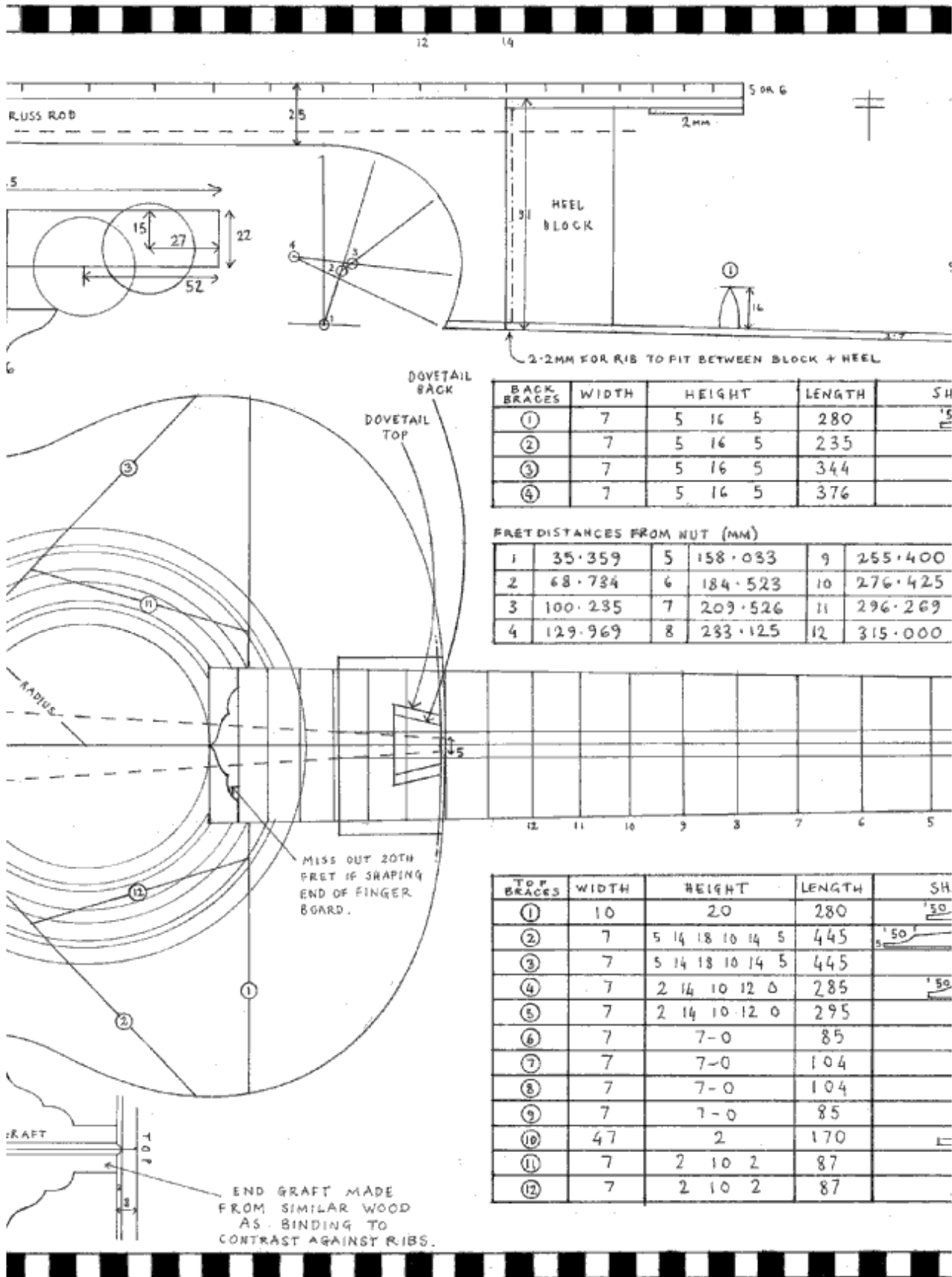

# Complete plan 3

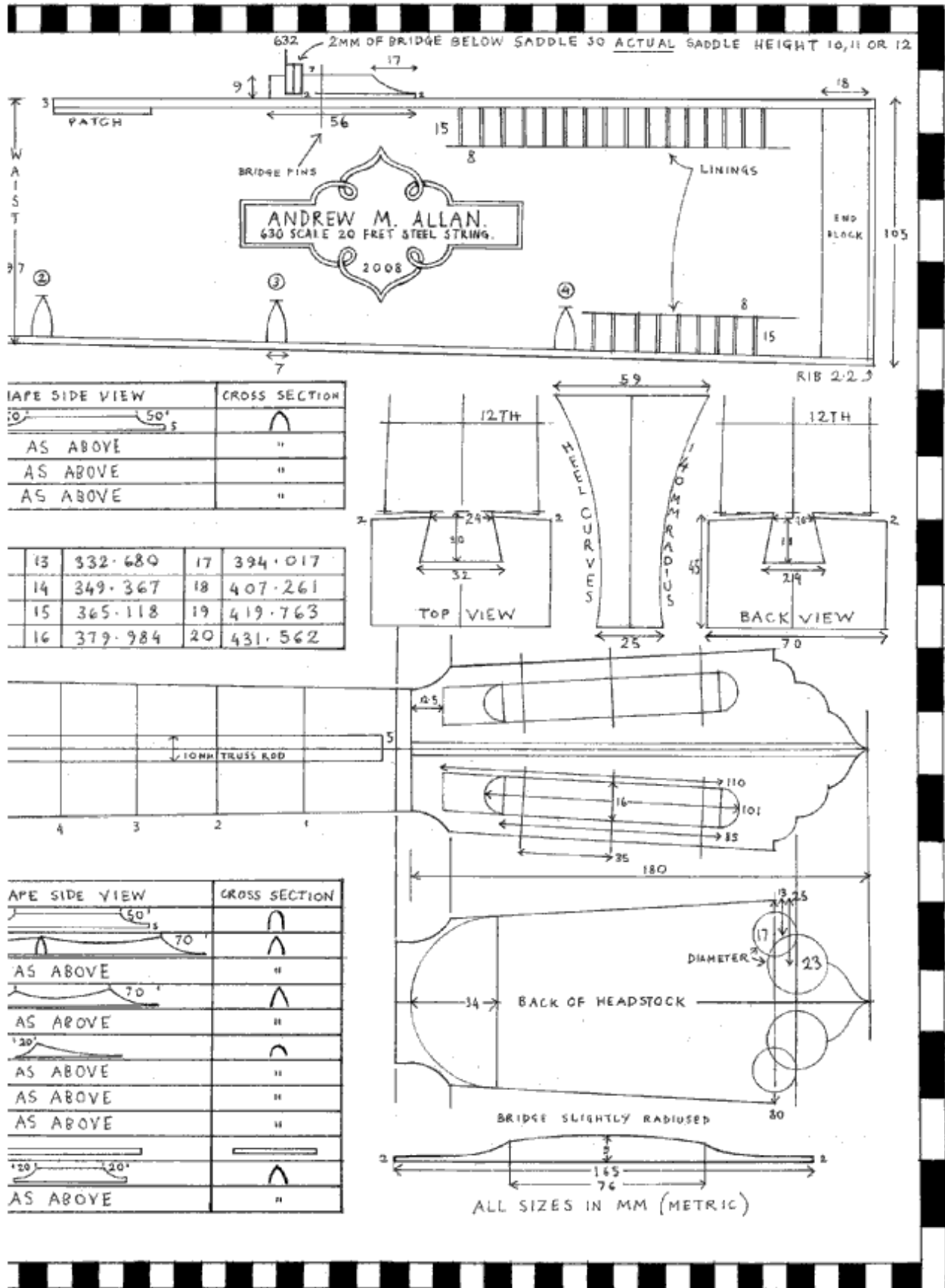

A copy of this full size plan is available to buy separately - email me at [zavijah123@hotmail.com](mailto:zavijah123@hotmail.com) for further info

## Costs of Building Materials & Disposables

GENERAL WOODWORKING					
item	supplier	price	item	supplier	price
80 grit sandpaper X 10 sheets	Axminster Unit 10 Weycroft Avenue Axminster Devon EX13 5PH	£5.10	double sided tape X 3 rolls	Local hardware shop	£3.00
100 grit sandpaper X 10 sheets	Axminster	£4.60	titebond 16 fl oz.	Axminster	£5.19
240 grit lubrasil X 10 sheets	Axminster	£4.60	1kg liberon pearl animal glue	Axminster	£9.31
400 wet and dry X 10 sheets	Axminster	£5.80	57ml zap ca superglue	Axminster	£8.21
1200 wet and dry X 10 sheets	Axminster	£5.80	standard 24 hr epoxy araldite	Axminster	£4.34
Stanley blades X 100	Axminster	£10.22	spray mount 200ml	eBay	£5.59
Scalpel 10A blades X 100	Axminster	£13.56	0000 25g fine steel wool	Axminster	£3.74
junior hacksaw blades X 10	Axminster	£2.16	ice bear sharpening stone kit	Axminster	£33.25
copying saw blades X10	Axminster	£4.80	latex gloves X 100	Axminster	£6.99
piercing saw blades X12	Axminster	£2.46	riggers glove X 2	Axminster	£1.70
band saw blades X 5	Axminster	£31.44	intego respirator & 1 extra filter	Axminster	£15.22
masking tape X 5 rolls	Local hardware shop	£3.00	pens / pencils / erasers	Staples, Glasgow	£10.00
parcel tape X 5 roll	Local hardware shop	£3.00	A1 cartridge paper X 10	Artstore, Glasgow	£7.20
Sub total =					£208.28

POLISHING DISPOSABLES					
item	supplier	price	item	supplier	price
carbon black powder pigment 500g	Smith & Rodger Ltd 34 Elliot Street Glasgow G3 8EA	£4.20 before VAT	cotton wadding 45 inch X 60 inch	www.cottonpatch.co.uk/	£4.95
thixotropic neutral wood grain filler 1 litre	Smith & Rodger Ltd	£15.15 before VAT	cotton flannelette sheet for rubbers & rags	Any Charity Shop	£3.00
Hessian for rags £2.90 for 36 inches X 1m	www.cottonpatch.co.uk/ 1283-1285 Stratford Road Hall Green Birmingham B28 9AJ	£2.90	elastic bands X 200	Staples, Glasgow	£2.50
vitapol	Smith & Rodger Ltd	£13.15 before VAT	burnishing cream 200ml	David J Dyke	£3.90
meths 1 litre	Smith & Rodger Ltd	£4.25 before VAT	Large yellow dusters X 5	Local hardware shop	£5.00
turps (not turps substitute) 1 litre	Smith & Rodger Ltd	£5.20 before VAT	lemon oil	Smith & Rodger Ltd	£7.95 before VAT
white oil	Smith & Rodger Ltd	£6.15 before VAT	tru oil 200ml	David J Dyke	£6.60
Sub total =					£84.90

## Costs of Building Materials & Disposables

FOR JIGS					
item	supplier	price	item	supplier	price
mdf sheet 1220 X 607 X 18mm	B&Q Paisley Abbotsinch Retail Park 1 Washington Road off Renfrew Road Paisley PA3 4EP www.diy.com	£7.58	hardboard sheet 610 X 122 X 3mm	B&Q Paisley	97p
exterior ply board sheet 1220 X 660 X 18mm	B&Q Paisley	£9.77	pine 4 pack 2100 X 34 X 34mm	B&Q Paisley	£5.51
1mm marine ply sheet (for templates)	Paisley Model Centre 80-82 Arkleston Road Paisley PA1 3TS	£7.50	750 piece turbo gold selection pack	www.screwfix.com	£9.25
Sub total =					£40.58

BUILDING MATERIALS FOR GUITAR					
item	supplier	price	item	supplier	price
brace wood for steel string (set)	David J Dyke The Hall Horebeech Lane Horam East Sussex TN21 0HR	£6.00	indian rosewood bridge blank		£2.70
brazil mahogany neck blank for slipper heel	Touchstone Tonewoods 44 Albert Road North Reigate Surrey RH2 9EZ	£18.37	bone saddle		£2.10
western red cedar top (grade AA)	David J Dyke	£30.00	bone nut		£2.30
indian rosewood back and ribs (grade AA)	David J Dyke	£55.00	rubner machine heads		£50.00
mahogany top block & bottom block (£1.50 each)	David J Dyke	£3.00	abalone dots X 10 + 40mm x 20mm abalone inlay piece		£10.00
ebony fingerboard (grade AA)		£14.00	ebony end pin (mop eye)		£1.90
mahogany linings (unkerfed) X 4		£3.40	ebony bridge pins (mop eye & groove) 90p each X 6		£5.40
Veneers 2 X red 2 X sycamore 2 X black 2 X mahogany		£30.00 including postage	2.4 x 1.2 medium gauge fretwire X 2 metres (£1.80 per metre)		£3.60
Bindings Rosewood + white X 4 (£1.50 each)		£6.00	threaded adjustable truss rod		£6.60
Sub total =					£250.37

TOTAL COST OF MATERIALS & DISPOSABLES FOR ONE GUITAR = £584.13

## Sequence of construction

### FIRST TERM

WEEK	Week beginning	PLAN OF WORK
1	09/10/06	Write Design Brief & Thickness Soundboard to 3.5mm
2	23/10/06	Finalise Rosette Design & Thickness Back to 2.7mm
3	30/10/06	Make Herringbone Block from Veneers
4	06/11/06	Fit Rosette and Final Thickness of Soundboard to 3mm
5	13/11/06	Cut out Dovetail Tenon on Neck & Make Dovetail Mortice on Block
6	20/11/06	Drill out Headstock Slots & carve/shape Neck/Heel
7	27/11/06	Thickness set of Ribs and Cut to size
8	04/12/06	Make End Block & Prepare Braces for Soundboard and Back
9	11/12/06	Thickness second set of Ribs and Cut to size & Make Kerfed Linings

### SECOND TERM

WEEK	Week beginning	PLAN OF WORK
10	08/01/07	Bend Ribs & Glue on Blocks
11	15/01/07	Make Steel String Solera & Glue on Soundboard Braces
12	22/01/07	Shape Soundboard Braces, Glue on Back Braces & Shape
13	29/01/07	Shape and Fit Ribs to Soundboard, Glue on Linings & Glue up
14	05/02/07	Shape and Fit Ribs to Back, Glue on Linings & Glue up
15	12/02/07	Week to catch up
16	19/02/07	Soundboard Purfling and Binding
17	26/02/07	Back Purfling and Binding & Cleaning up
18	05/03/07	Fitting Neck Dovetail and Checking Neck Angle Before Gluing up
19	12/03/07	Slotting Fingerboard and gluing on & Cleaning up Neck Profile
20	19/03/07	Inlay work / Dots
21	26/03/07	Fretting and Cleaning up Fret Edges

### THIRD TERM

WEEK	Week beginning	PLAN OF WORK
22	16/04/07	Week to catch up
23	23/04/07	Cleaning up guitar to prepare for finishing
24	30/04/07	Finishing & Making Bridge
25	07/05/07	Finishing & Making Bridge
26	14/05/07	Finishing & Making Bridge
27	21/05/07	Stoning and Profiling of Frets & Fitting Machine heads
28	28/05/07	Locating and Gluing on Bridge & Making Nut and Saddle
29	04/06/07	Intonation & Final Burnishing
30	11/06/07	Guitar Should be Complete

## Record of Timber Names, Densities, Frequencies & Weights

GUITAR CONSTRUCTION MATERIAL NAMES AND DENSITIES			
Woods:	Part of Guitar:	Botanical Name:	Density:
Canadian Western Red Cedar	Soundboard	<i>Thuja plicata</i>	233 kg/m <sup>3</sup>
South American (Brazilian) Mahogany	Neck, Linings, Back braces	<i>swietenia krukovii</i>	533 kg/m <sup>3</sup>
Indian Rosewood	Back, Bridge, Ribs	<i>dalbergia latifolia</i>	702 kg/m <sup>3</sup>
Ceylon Ebony	Fingerboard	<i>diospyros ebenum</i>	1111 kg/m <sup>3</sup>
Syacamore	Back centre piece, End graft	<i>acer pseudo platanus</i>	526 kg/m <sup>3</sup>
Douglas Fir	Soundboard braces		

RECORD OF FREQUENCIES & WEIGHTS MEASURED DURING CONSTRUCTION		
Part:	Tap Tones / Resonant Frequencies:	Weight:
Ribs (first set) thickened and cut to size	Not Taken	143 g & 148 g
Ribs (second set) thickened and cut to size	Not Taken	Not Taken
Back before bracing	65 - 69 Hz 2nd Octave C <sub>2</sub> or C <sub>#2</sub>	315 g
Back after bracing	Not Taken	Not Taken
Soundboard with soundhole (s/h) patch before cutting s/h	Not Taken	168 g
Soundboard with s/h patch after cutting soundhole	87 - 92 Hz 2nd Octave F <sub>2</sub> or F <sub>#2</sub>	153 g
Soundboard with s/h patch and bridge patch	Not Taken	Not Taken
Soundboard with both patches and fully braced	185 Hz 3rd Octave F <sub>3</sub> or F <sub>#3</sub>	253 g
Body Complete	Not Taken	Not Taken
Body Complete with Purflings & Bindings	98 Hz 2nd Octave F <sub>#</sub> or G <sub>2</sub> F <sub>#</sub> or G after bass E String on guitar	1164 g
Body with Neck glued on	Not Taken	Not Taken
Near Completed Guitar with fingerboard glued on	Not Taken	Not Taken
Completed Guitar with Bridge glued on	Not Taken	Not Taken
Completed Guitar with Strings Tensioned to Pitch	Seems to resonate between F and F <sub>#</sub> after the bass E and also F and F <sub>#</sub> in the next octave up though not the treble octave. Perhaps this explains why there is less sustain in the treble strings.	Not Taken

*Steel string cork solera*

## *Solera using cork*



*This solera for holding the steel string guitar body together during construction differs from the classical solera (see pages 17, 18 & 19) with the use of a surround of pieces of cork to make up for the lack of a scooped out area on the solera into which the guitars curved soundboard surface can be supported safely during the gluing on of the guitar end blocks and ribs (sides).*



## *Rope design for purfling*

## Initial attempt to make herringbone purfling

wheat pattern 06

Although I am going to make a steel string guitar, I quite like the idea of making a mosaic style rosette in the style of the Spanish makers.

I particularly like those with a rope or herringbone motif as part of the design so decided to go for this to begin with.

I had bought a mixed pack of veneers which was comprised of about 40 all different burr and straight grain veneers around 210 x 300mm in size.

Unfortunately I think there was a bit too much of a selection of colours and grains in this packs for what I was intending to use it for but since I had already bought it I decided to make use of it.

Initially I made up the plan to the left (inspired by the article by Gregory Byers in *American Lutherie*) and from that decided to cut up the veneers into as many 150 x 30mm strips as I could manage. After I had cut all the veneer I had into strips I then began to

separate the veneers into piles of light, medium and dark and from there made an interpretation of the design. I then sorted

them into sequence and began to glue them in piles of 6 or 7 with titebond. Once glued in piles I took a cross section photograph to check progress (below).

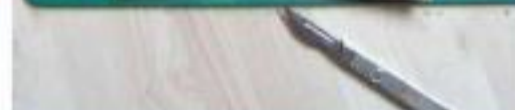

## Cutting into strips for possible rosette or purfling design



I decided to draw the offset angle for gluing the veneer piles across the edge and then use this as a guide for gluing up the piles one by one using the mini G clamps. I used small pieces of thin ply to protect the veneers from the pressure of the G clamps.



Once the angled pile was glued up I then planed all the surfaces to check how accurately the veneers glued together. I then planed what would be the bottom face totally square then planed an edge square with the bottom face. Squaring these edges helps to ensure that when it



comes to slicing up the block on the band saw, each slice taken will be the same thickness etc. After this I cut a 2 to 3mm slice from the

block, then planed the cut surface of the block flat once again. I repeated this 7 times until I had 7 strips that had one good and one rough face.

One strip I cut up and used for the first rosette idea (next page) and the other six I set up on a board as shown in the photographs above, ready to be glued to a backing veneer which will help to keep the rope pattern pieces together whilst bending. I set out 2 long strips of double sided tape on the board leaving the shiny glue resistant backing paper on to prevent the two lengths of backing veneer from sticking when gluing up. The two veneers were approximately 750 x 30mm. I made 6 individual mdf clamping cauls to clamp each individual piece of rope down onto the 2 backing veneers. I left a gap at the area inbetween each section in order to make sure each diagonal joint was joining exactly. Once I was sure of this I was able to clamp just over the top with the next clamping caul. I also had to make sure that the both edges of the sections of rope were staying true with the both edges of the backing veneers. With these glued up I should get maybe five strips from each of the two, so potentially 10 strips which should give me plenty as regards rope for purfling and herringbone for the rosette.

## Planing glued strips to an even thickness and cutting into strips

When all the clamps and blocks were removed the two 750 x 30mm strips were fine. The next job was to plane them down to about 2.6mm including the backing veneer. Firstly I double sided one strip fully to the bench then attempted to thin it using the 5 1/2 plane, checking with the end of the vernier caliper that it was going down to the 2.6mm but Robert suggested that there was no way of being sure that it was even all the way from one end to the other so following his advice I double sided two runners of layered veneers on the plane either side of the

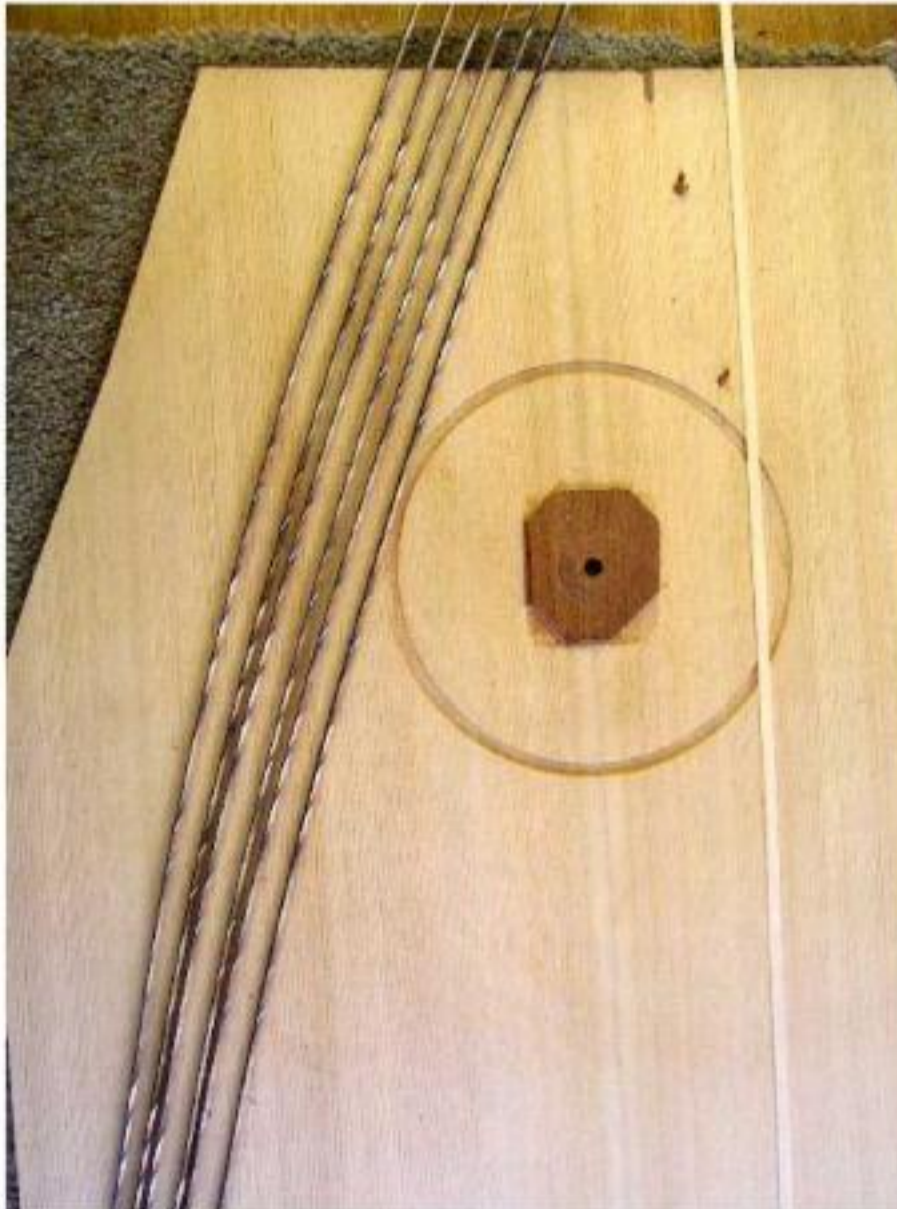

blade. This method worked really well and made the whole process a lot quicker - just a matter of keeping going until it will cut no more. Obviously here a fine plane setting is needed to ensure the blade is not cutting too much beyond the thickness of the runners. I thinned the strips to about 2mm in the end but it looked fine and perhaps the thinner each strip is the more subtle it will look on the overall design.

Once the two 750 x 30mm strips were planed down to 2mm or so, I then had to cut them into individual strips. Out of the first of them I managed to get five strips each about 5mm wide. I wasted one for the first rosette idea. I used the next two for the 3 piece back join (from which I also had enough leftover for the headstock veneer centre strip). The last two from this strip I used for the first attempt at a glued up herringbone, which in the end didn't work. Because I only had one of my two initial glued up strips left, I made a special effort to try to bandsaw six out of the

one. I clamped a guide up for the small bandsaw and tried to do a couple of test cuts to make sure I was taking into account the width of the sawcut and how much I was losing due to this. Thankfully I managed this and now had 2 purfling strips for a herringbone and 4 for back and front purfling. Hopefully no mistakes though as now have no margin for error.

## *Soundboard rosette & bracing*

## First try at making a rosette



In order to make a veneer rosette I first made a jig from 2 layers of mdf with a further 2 layers of 1mm marine-ply screwed on top of the mdf. I then set up the pillar drill with the circle cutter bit and set my rosette sizes and then cut into the marine ply just deep enough to cut through both layers



but not into the mdf. I cut out 2 rosette sizes - one larger but a narrower band for the steel string and also a smaller wider banded one for a classical for later use. I took the seventh piece of rope that I had cut into strips and made up a herringbone as a tester for a rosette design. I glued a black veneer in the centre of the two and allowed to dry. I made up 2 of these then thinned using the block plane to about 4mm wide.



In the absence of a hot bending iron at home I soaked each herringbone in hot water for 10 mins and they seemed to bend at least a little. Was worried they would break up because of this but they seemed to stay strong. Perhaps 30 mins next time to see if this makes them bend easier. I had to make use of map pins as



the strips took a bit of forcing into place with the end of the steel scalpel handle (with the blade removed). Once one herringbone was pinned and glued to the 2 inside white veneers, I then added in a covering white to the herringbone and pinned this in place to dry for an hour or so. After this I



repeated the process around the outside edge of the rosette using the remaining herringbone. It became apparent here that the herringbones were not long enough for this rosette to be of any use on the actual guitar, but I continued anyway just to get an idea of what it might look like.

I filled the space in the middle with 2 mahogany, 1 white, 2 blue, 1 white and 2 mahogany. This filled the space quite well and when I glued all these in place and planed it back with the block plane I was quite impressed initially. Think though was not happy with way the wheat pattern only appears once in the full 360 degrees as it makes the rosette seem a bit unbalanced. One way round this would be to only have ONE herringbone in the centre and to make the wheat motif appear underneath where the fretboard will be. Around the central wheat on either side could maybe be plainer contrasting colored chain or ladder, with also a few lines too.



## Seeing how this new rosette idea might work

I cut two pieces of she oak on the band saw about 140 x 70 x 4mm and glued them together at the edge. I did not bookmatch them but instead turned one top to bottom to make the grain seem as though it was one piece of wood. I then glued that piece to a piece of thin plywood and screwed this very securely to an mdf base. I then clamped the block of mdf to the drill table and drilled a 1/4 inch hole through the centre of the joined she oak. Next was



to set up the circle cutter bit on the pillar drill and transfer the measurements that I had planned to be the size of the rosette onto the wood itself making sure to check the diameter of the circle to be cut. I did this by aligning the cutter tip up with my pencil marking and then spun the cutter tip around making sure it was following the drawn line exactly. The cut was a little bit shaky but worked out ok.

After cutting the ring out I then realised I should have first made two cuts half way through in the centre part of the rosette as the channel into which the herringbone would sit. After this I would have inlayed the herringbone and only then went back and cut out the full rosette ring. Once I had cut the rosette I noticed there were 2 bad grain cracks in the ring which I bonded together with animal glue. The pulling together action of the



animal glue is I think what has caused the ring to pull out of shape a bit and as it is hardwood it seems pretty rigid. Had another look at the original purfling I made and decided maybe it wasn't so bad so have left the ideas on this page to the side for the moment.



*Re-thinking original rope idea*

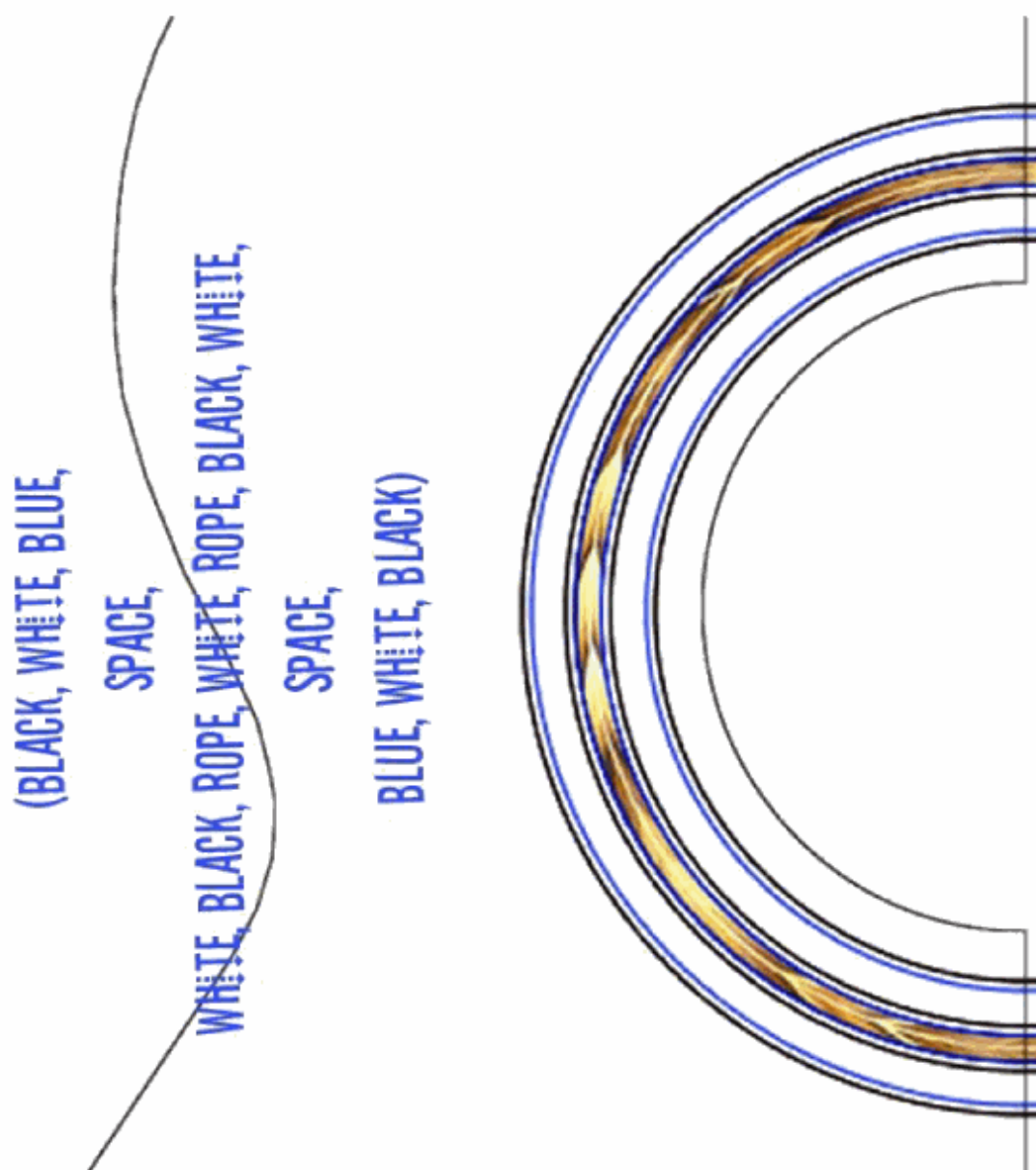

## *First and second attempt at new herringbone idea*



*Paul suggested gluing the 2 pieces of rope together before bending so I did this. The first attempt at animal gluing the ropes together failed halfway in a sticky mess, at which point I thought maybe the titebond would be better and give me more time to get them firmly joined. Once glued I measured how thick the herringbone band would be with the vernier caliper and this let me get on and cut out the channel on the soundboard using the*



*circle cutter on the pillar drill. Once I had made the 2 cuts in the soundboard for the herringbone channel I then began bending the now dry herringbone on the bending iron. The herringbone had 3 veneers holding it together; one either side and one in the centre. It did bend but it also started to warp quite a lot and this was mostly due to the inside and outside veneers (inside one being compacted while outside one being stretched). What I should have done here was plane off the outside and inside veneers before bending and then I think it would have worked a treat.*

*I tried to remove the inside veneer later and to help it bend a bit more I thought I'd soak it in some warm water. This didn't work and it fell apart a bit. I then realised I'd need to do a new one and figured I'd just try to join the herringbone IN the channel instead of doing it beforehand. The only disadvantage being that the difference in size between the inside and the outside circles means that it is impossible to get the pattern to match up as it will always go a little out of step. I routed out the channel with the mini grannys tooth to about 2mm deep. Bending the ropes individually was a lot easier and once this was done I experimented with the best way to lay out the pattern. I decided to inlay it asymmetrically which was the way it was supposed to be and this worked out good too as the pattern matched up better this way than if I had put it in fully mirrored. Happy with this I animal glued the herringbone in place in the rosette channel on the soundboard.*

## Mistake with cutting channel on either side of the herringbone

I animal glued it in place a bit liberally and had a lot of glue to clean off. Paul suggested hot water again on a cloth but wrung out fully so as not to wet the soundboard too much. Did this until I had most of it cleaned and then sanded and scraped the whole thing down a bit too. Next followed the same process of cutting to cut out the 2 channels for the inner and outer rings which were to be 5 ply veneer per ring. Went very carefully, measuring all the way but when I had finished and unclamped the soundboard, turned it over to find I had went all the way through almost on the 3rd cut! Paul said I should not have cut 2mm deep as 1.5mm at most would have

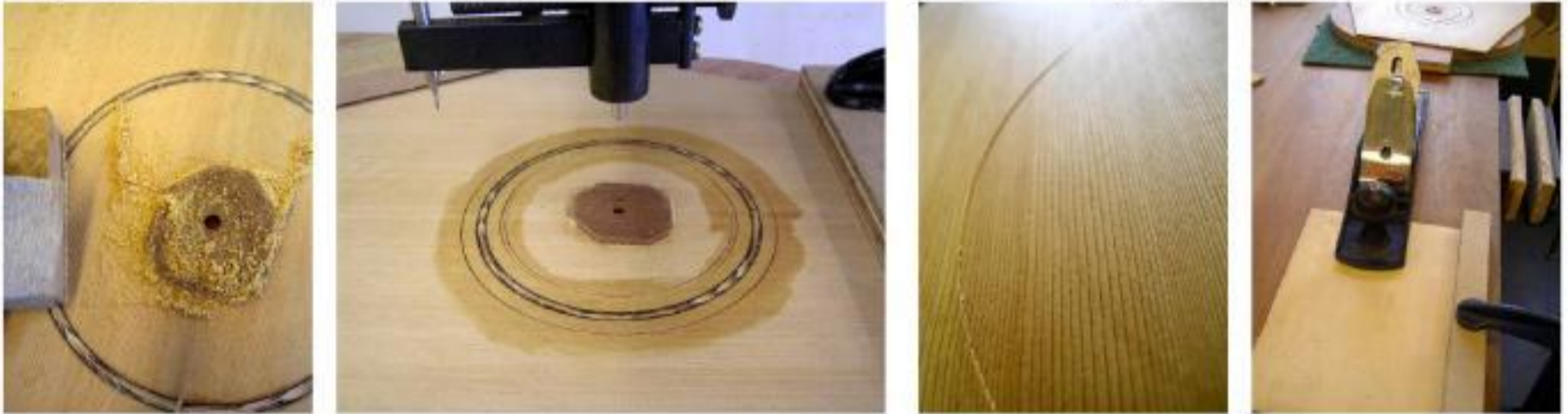

been enough. I went to 2mm as the herringbone slot had been 2mm when checking with the vernier but think I had only went 1 and 3/4 with the cuts for that. Due to this mistake I had to then add the patch to the back immediately and had to opt for a round patch instead to secure the circular cut around the soundhole. I did this as shown in the following photos with the grain of the patch running the same direction as the soundboard as normally it would have been. I could have put the patch the opposite way which would have strengthened the area I cut into more but in the end I guess it is important to think of the great tension the strings will have on the soundboard and to strengthen it in relation to them. A thought I had later was to have made the central pentagonal patch as normal and used pieces of rosewood to fill up the pentagon shape into a circle. The rosewood pieces would definitely have strengthened the cut area, especially when the patch has to be cut when the X braces go on.

Because I now had a patch I had to think off a way to support the area around the patch while inlaying the next parts of the rosette on the other side. I used a thin piece of mdf / hardboard which seemed to be perfect in terms of thickness.

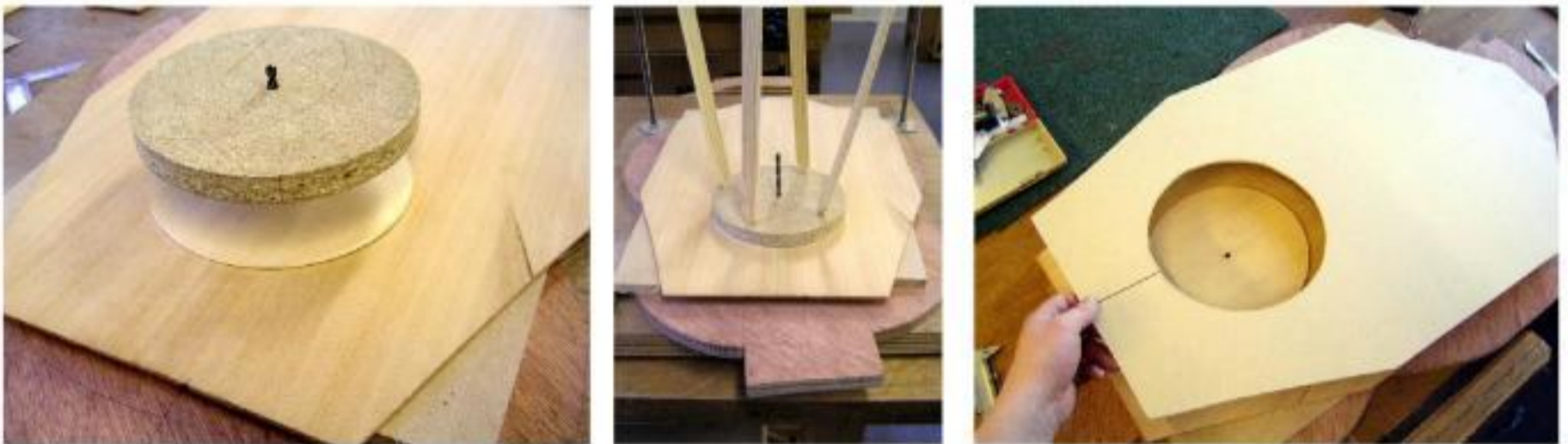

## *Inlaying two lines around herringbone before thickening*

*With the board underneath supporting the soundboard I then used the 2mm granny's tooth router to rout out both channels down to about 1.75mm deep. I decided to use mahogany, black, white, black, mahogany for both lines as the reddish color next to the cedar made it almost invisible and made the black, white, black look a bit finer and thinner. While routing I realised that some of the titebond used for the patch had seeped back through*

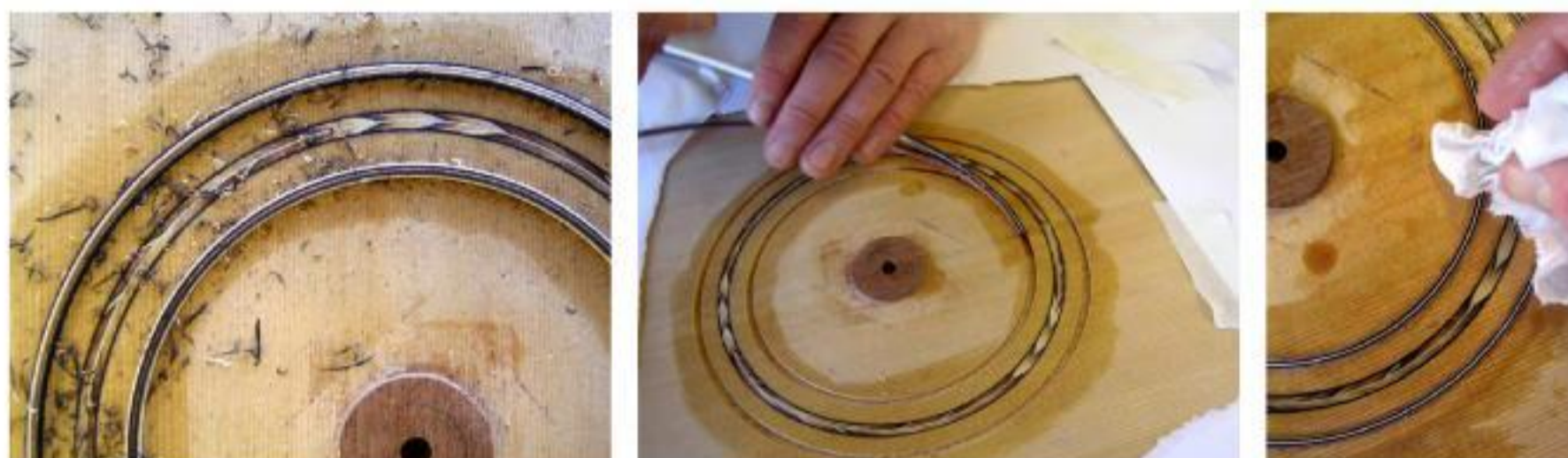

*the cut into the channel and had blocked it up a little so I had to then redo the cut on the pillar drill again. Re-centering it was not easy and took a lot of manouvering about of the soundboard on the drill table, then checking where the cutter was sitting in relation to the cut already made. I took my time with this and finally got it in the right place. The first cut though was too little so I had to readjust and cut a tiny bit more off to break away the titebond. Because of this the cut was about 3mm wide instead of the 2.6mm it should have been. I tried putting another veneer in thinking I should even out the two channels but decided it was fine as the gap was less than a veneer thickness at 0.4mm. I then inlayed them and measured out the correct length to fit it in fully to the end underneath where the fingerboard will be. Once in place without being glued I planed them down a little to make sure they were near even so they will be all the same height for when pushing in place when gluing and weighting down at the end. Next I used the hot animal glue and glued them in place. This was quite messy AGAIN, probably just because it's a race against time before the glue cools down. One veneer broke and luckily I had an extra close by which I fixed up as quick as I could. After glued I put on a heavy disc of steel and a couple of weights and left overnight.*

*Next day I had to then clean up all the heavy gluing I had done with hot water and a cloth. This time it cleaned up a bit easier. Did notice though that on the outer ring which was ever so slightly larger than the inside that there was a tendency to end up pushing dirt into the slight gap so guess it's important to get the veneers just fitting and no more. After cleaning the rosette area I left it to dry over the weekend. I then just cleaned it up using a light scraper and some fine grade sandpaper.*

## Thickening soundboard



## Repairing and studding a major crack in soundboard

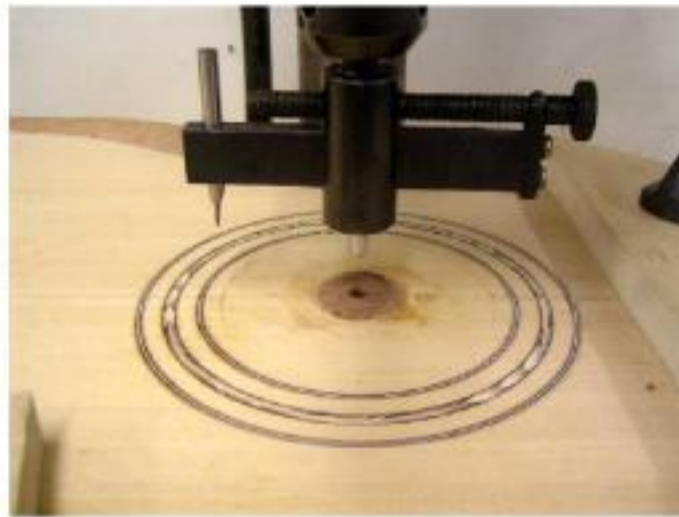

I got the soundboard thickened to about 2.9mm or thereabouts and cut out my shape using the template. I then used some rough sandpaper around a jar to refine the shape. Unfortunately having just got the shape correct, I lifted the soundboard at the edge of the lower bout and it cracked. Quite a long crack from the end nearly to the waist! What I had to do next was hot animal glue the crack and hold together the two sides for five minutes then finally weight down the whole soundboard overnight.

Next day I cut out the soundhole to 98mm and after this I cleaned off the excess animal glue on the crack with some hot water making sure not to go too close to the crack line itself. Paul suggested studding the area in the same way as from the repairs logbook, to strengthen the join but without affecting the flexibility of the soundboard. I made up some studs from a piece of douglas fir, about 15mm long and about 7 or 8mm wide. Height-wise each stud was about 1.5mm. I marked out all my brace positions on the soundboard and worked out from this where to stud the crack. The studs were approximately 300mm apart and I placed them so as to avoid the brace positions.

Here I placed a piece of masking tape as a guide line to keep them all in alignment and

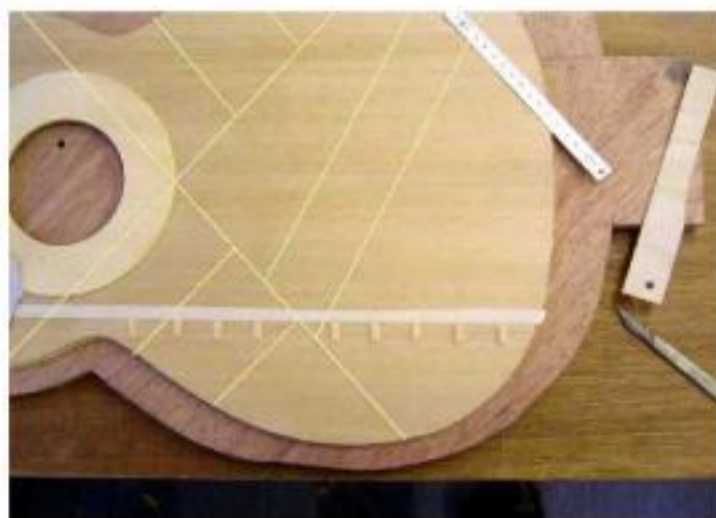

also I decided to pencil in the position of each stud on the masking tape to keep the studs the exact same spacing apart. With this done I

then hot animal glued the studs on and cleaned around each after gluing with a slightly damp brush.

## Shaping soundboard X brace then gluing bridge patch



Jan 12th: At this stage I was ready to glue on the rosewood under-bridge patch which had to be 5mm wider than the bridge on either side (in front and at back of the bridge). I realised at this point when I will be fitting the braces it would be good to mark the brace positions onto the soundboard in pencil showing the full widths of all the braces. This is to help position the braces more accurately when gluing them in place. Next I had to chisel then rout out (with grannies tooth) three channels in soundhole patch to allow the x brace to fit flush with the soundboard.

I realised a paring chisel would have been handy here for the added reach. For the top harmonic bar channel I found the grannies tooth was much more effective and safer too. I next took the two bars of douglas fir for the x (I had planed them to size earlier) and curved them to the solera shape in the same way as last year. Once the two parts of the x were ready I placed them on the guitar top to work out where to make the half-lap joint that strengthens the whole x brace.

I marked the half-lap bottom part at 9mm and the top half was more as both braces were still about 20 - 21mm high (eventual height at crossing of the x will be 18mm).

Once the half lap was done I then marked up a piece of spare rosewood from a rib and cut it roughly on the band saw leaving it at 3mm thick as can thin it to 2mm once glued to the soundboard. I cleaned it up the edges of the patch using the 5 1/2 plane on the shooting board. Once done I then was able to move the solera into the go bar press and go bar the x in place as a guide for positioning and gluing on the bridge patch (with titebond). The patch was glued with a caul just slightly smaller than the actual bridge patch itself. Normally here the soundhole patch would also be being glued on but as I had already done this, I placed a round caul on top of the soundhole and go barred it in place just to make sure that the soundboard was being forced down onto the solera as fully as possible while the glue is drying. Next day (15th) I masked around patch and block planed until 2mm thick.

Once the half lap was done I then marked up a

piece of spare rosewood from a rib and cut it roughly on the band saw leaving it at 3mm thick as can thin it to 2mm once glued to the soundboard. I cleaned it up the edges of the patch using the 5 1/2 plane on the shooting board. Once done I then was able to move the solera into the go bar press and go bar the x in place as a guide for positioning and gluing on the bridge patch (with titebond). The patch was glued with a caul just slightly smaller than the actual bridge patch itself. Normally here the soundhole patch would also be being glued on but as I had already done this, I placed a round caul on top of the soundhole and go barred it in place just to make sure that the soundboard was being forced down onto the solera as fully as possible while the glue is drying. Next day (15th) I masked around patch and block planed until 2mm thick.

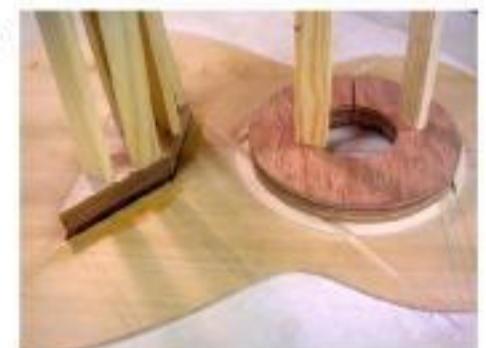

## Gluing down braces and shaping



At this point I also prepared the top tranverse brace which needed a very slight curve in it due to it being braced on top of a fully circular solera.

These then were glued on again overnight and next morning (17th) I was then able to plane down all the braces to height with the block plane and then using a  $\frac{5}{8}$  chisel carve to curve the shape of each. The two harmonic bars then needed to be carved into a pointed shape using the chisel too - I tried using the small palm plane I bought but being aluminium it started marking the wood a little for the harmonics even although on the top tranverse it seemed to work fine without marking the wood. After this I scalloped the ends of these braces and then rounded a little using sandpaper. I then tried the X brace on and it was fitting close but not quite. Left to next day to tackle.

Jan 15th: Having already prepared all the braces to 7mm wide (except the top tranverse bar) and having cut them roughly to length, I now was ready to begin gluing them to the soundboard starting with the shortest braces nicknamed "finger-braces". I placed these on the soundboard onto the pencilled on guide lines which I made 7mm wide in order to ensure the braces will not go askew while gluing. Once in place I measured out from the edge of the soundboard an amount of 2mm for ribs and 5mm for the linings - and marked each finger brace according to this. The finger braces and the 2 harmonic bars at the lower bout do not get recessed into the linings unlike the tranverse and the X. Am assuming this is to allow the area to be strengthened without constricting it's ability to vibrate freely. Having cut them to length I then glued them in place. Height wise the finger braces would be 7mm at the peak so left them at 10mm high to allow for the dents that would be made in each brace from the pressure of the go bars.

Next day (16th) shaped these to almost finished requirements and then preceded to make the slight curve in the lower bout harmonic bars using the shooting board and 2 clamps. Once I had achieved the correct curve I then went on to position these ready for gluing, again cutting them back to 7 or 8mm away from the outside edge of the soundboard and at the other end leaving them 1mm back from where they both meet the X. Here I made a mistake and cut off an extra inch on one of the two braces due to too many pencil lines and had to make another





## Final fitting and gluing of X brace



Jan 18th: Today tried to solve problem of X brace not sitting quite flush with solera. To do this first of all cut length of each part of the X to it's finished length of 2mm away from edge of soundboard. The X will be recessed into the linings to give the guitar top maximum strength. After this was done the X was still not fitting exact. It seemed to be rising up at all ends so it seemed that the center cross was perhaps needing flattened slightly. I started doing this with a sanding stick but soon realised I was perhaps making



the surface to be glued a bit uneven because when I placed the parts of the X on individually they now seemed to be rocking slightly left and right along the length! Here I decided I better get the shooting board out again and do it this way to make sure each edge was consistently flat. Here I made a mistake as I tried to bend one of the braces as before using the 2 G clamps but when I went to pull back the brace I heard a slight cracking so when I undid the clamp I could see a slight crack where the half lap was cut out. I decided here that I would continue on and not make another brace but instead just clamp the braces flat withouth bending them as I was only attempting to take a little bit off the centre bump where they cross. Did this little by little realising the patience needed to get this job done and realise this is how I should have approached it in the first place before cutting the half lap. Gradually I got both parts of the X fitting quite well singularly, however when I joined them together again and tested them there was now a slight half a mm gap under the cross of the X. To see if this was caused by the channels in the soundhole patch I made a couple of sanding sticks to try to take away any excess lumps and bumps which may have been causing it to not sit flush to the soundboard. I also ran a spare piece of brace wood along the two channels to try to square off each edge to allow the braces to sit firmly in place. This helped a bit more but did not resolve it fully. I thought about how to fix the problem for about 10 minutes maybe and then came up with idea of putting a small circle 30mm in diameter of 0.6mm sycamore veneer under the soundboard at the point the x rests to lift up the soundboard just enough to correct this error in the X shaping.

Finally got humidity down to about 42% and glued up with titebond using go bars about 1 inch apart to ensure maximum spread of force on the X.

## Shaping X brace



Jan 19th: The X brace now glued on, it was time to start shaping the braces according to the plan. To begin I first of all marked the heights onto the X

brace at the appropriate points and then block planed it all down to the correct heights. I then initially chamfered the brace edges away with the small palm plane but then moved onto the 5/8 chisel as I felt it was a bit more accurate for shaping.



I concentrated on shaping the X brace into an arched shape point at the top edge avoiding about an inch of a crossover at the center of the X which is where a hardwood 'cap' will be glued on to strengthen the half-lap joint.



Jan 24th: I then began to mark on the lower points on the lower bout section of the X where the brace reduces down into a valley as low as 10mm then curves back up

again to about 14mm before the end 70mm of scallop. To get all the scallops and these curved dips as accurate as possible I made up some curve templates from thin plywood (a french curve would have been handy here) and drew onto the side of each brace in pencil what I was aiming to chisel away. After the hollowed out areas were chiseled I then did the same with all 4 scallops. Next I made a little V shape sanding block to use to help shape the pointed edge of the braces. This worked a little but I improved it later by sawing a further notch into the V so that the sandpaper could be wedged in further (a bit like the fret burnisher we made last year). After this I also rounded the valley areas of the lower bout braces using some 100 grit sandpaper and tried to also clean the corners on the soundboard where the braces had been glued on. Finally I tried to clean off the scallops a bit more but was using a round dowel sanding block which Bill pointed out would just make the scallops more uneven. He suggested just a small folded up piece of 100 grit and the pad of my finger to smooth these areas.



## Finishing X braced soundboard



Jan 25th: With the braces close to finished dimensions I was then able to move onto capping the central crossover area of the half lap joint. Initially before gluing the cap in place I made sure the area was perfectly flat by further sanding over it lightly with a flat sanding block. I then glued (titebond) and clamped the cap in place on the go bar press using two go bars pressed onto a small caul also made of sycamore to keep the cap free from indentations. I then went on to shape this cap and the surrounding area of the X which I had left untouched until then. I pencilled in a rough shape of an oval and gradually and very carefully carved away until I felt I had blended the cap into the brace to make it almost invisible. Finally I went all around the cap and surrounding brace using a small sanding stick and also some folded paper to try to blend in the whole thing a bit better paying attention to how the cap was gradually blending into the X brace arch shape.

Jan 26th: Having not already rounded off the inside of the soundhole I thought it would be best to do this before going any further. The first picture here indicates the chiselling directions to go as regards grain. Going the opposite way from these directions usually ends up in the wood tearing. Here I had to take some time out and re-



sharpen and grind all my chisels which were just not sharp enough. Also noticed here my chisel angles were too low - less than 30 degrees so think that's maybe why



they were blunting so fast - having re-ground 2 of them I feel maybe this will improve the length of time they will cut well for. Once this was done I set about chiselling the soundhole patch inside edge trying to take it down to just before the actual soundboard / patch join. Also here I did a little fine sanding of the soundhole to make it a bit clearer where this join line was. I kept checking from the other side to see if I was making the appearance of the patch invisible enough from a players point of view. Gradually I felt I had rounded it enough and then set about refining and rounding the shape with a little bit of 100 grit then 240 grit sandpaper. Job done. Next stage will be gluing on blocks (page 75).

*Patch to tidy up rosette under fingerboard*

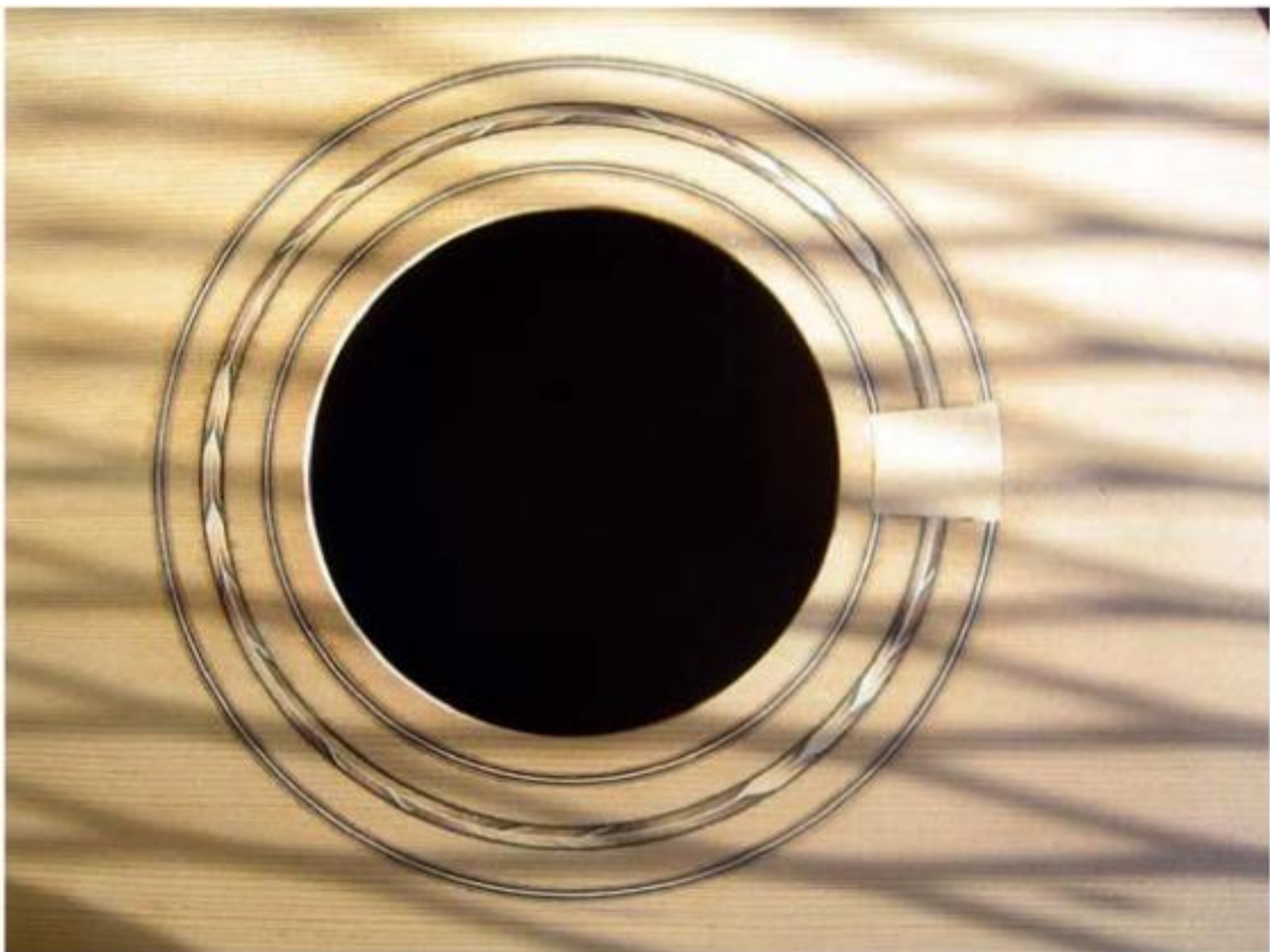



*Three piece back and bracing*

## Deciding to make a 3 piece back

When joining the rosewood back I made a big mistake and joined the 2 boards top to bottom. This was maybe because the book matching grain lines were an inch further in on one of the boards which I didn't notice at the time. The outermost corners seemed to match so think that was what made me think that it must be right. When it was glued I knew there was something wrong and looking down at the grain from the end I could roughly see what I think I had done. I had to then bandsaw 2 halves apart again and gradually work my way towards finding the matching grain lines. It took a while trying to work out which grain lines matched. At this stage I thought I would still have enough width to fit the body shape in but when I had finally got a good mirror image bookmatch I had planed off way too much: a whole inch in fact on one side. Sort of thought maybe I could just adjust the body shape but then remembered a guitar from last year with a 3 piece back and figured this would be the solution.

Bill gave me a nice piece of flame maple about the right size for a centre patch. Decided that I would use the rope purfling on either side of this to make it match the eventual binding. Drew a centre line at right angles across the flame grain and laying the 2 rosewood boards on top of this worked out how wide the patch would have to be to accommodate the full width of the body shape. I tried to add in maybe 8 to 10mm extra either side as knew I would have to shoot all 4 edges afresh to make sure they all were going to join up flush.

Had to think through the sequence of shooting the edges, making sure I was flipping over each opposite adjoining

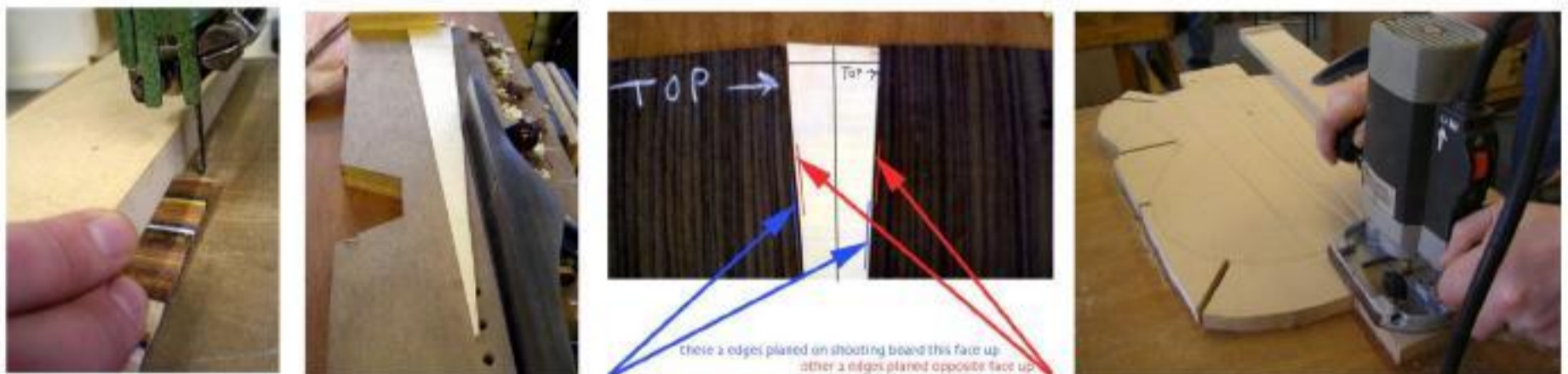

edge to ensure the plane blade cutting angles matched (see above). Decided to go for a long thin triangle and hopefully can make the tip of the triangle extend onto the heel cap.

Before gluing the rope purflings into the gap between the boards and the centre patch, Paul suggested routing 2 grooves into an mdf board and this would allow the herringbones to sit a bit deeper than the bottom edge of the board and reduce the chance of any part of the purfling rising out of the gap anywhere by mistake. I set the router up with a piece of mdf to act as a guide edge. Drew around the V shape and used a 10mm router bit and routed down the centre of the V to maybe 1 and a half mm though this ended up more like 2mm in the end.

## Gluing up pieces with rope purfling / herringbone inbetween

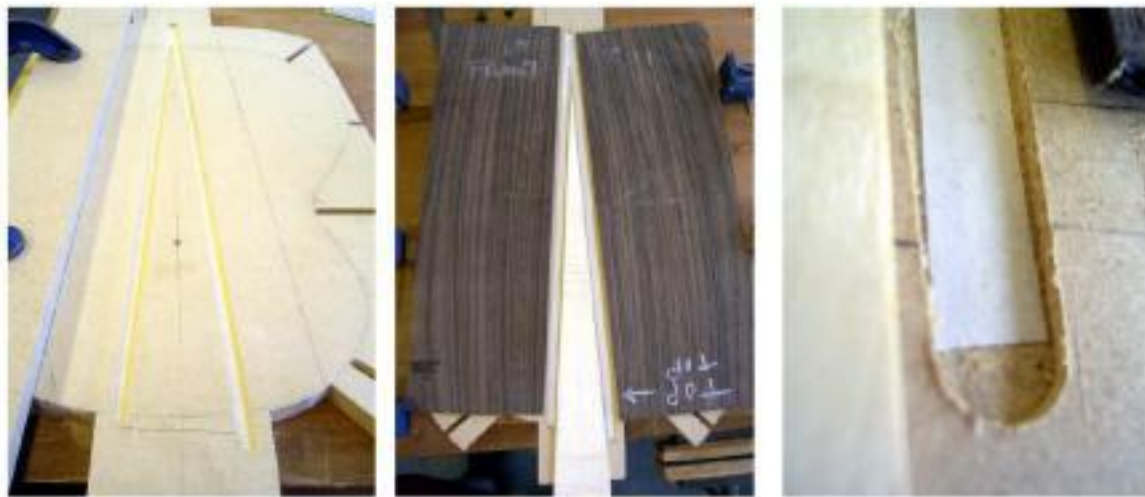

Once this was done put doublesided tape, leaving the shiny backing tape onto the gluing jig to lessen the chance of the purfling sticking to the mdf when gluing. Prepared two clamping cauls to go over the wood and one central V caul to fit over centre patch. Made 3 separate cauls as rope purfling will be sticking out of the gap by 1 or 2 mm. Also it will

allow me to see if I have joined everything up correctly as I will see where the glue is squeezing out. Did a full dry run to make sure I had planned everything out. Paul suggested a stop block at tip of v to make sure the 2 rope patterns were aligned in sequence. This also helped anchor the 2 rosewood halves too. Once this block was in place I removed the wood from the board and placed 2 anglepoise style lamps over the area in which I would be gluing and place the hygrometer to measure the local area humidity. When it finally reached around 45% humidity I began the gluing up sequence. First I applied titebond glue to the 2 rosewood edges one after the other,



placing them back down in place on the mdf board. I then put glue down edges of the V maple patch and placed loosely in position. Next I took the two herringbones and mistakenly placed them the opposite way round to how I had decided they would go! I noticed and swapped them quickly round and pushed the V shape closer into the joint like a wedge making sure everything was staying true to the channel underneath. I then gradually tightened up the 3 sash clamps, occasionally having to push the boards down at the edges. Before over-tightening I then put on the 3 clamping cauls while also keeping a watch on the 2 join lines to see the glue was squeezing out evenly. I tightened them a little more and

put the weights on top and then tightened them a little bit more still as there was a section of about 1 inch on one side that seemed to have no glue squeeze-out happening. This may have been due to the mistake of placing the ropes the wrong way round and then switching them again, causing the glue to be unevenly spread. Hopefully though there will have been enough on it to bond everything. One thing I noticed though was that the herringbone had veered off one of the channels at one end causing one of the boards to rise up a little bit. Hopefully this will be fixable.





## *Cleaning up 3 piece back and removing two pieces for headstock*



*Once the back was glued together I used the block plane to take the rope pattern down to the same level as the rosewood on both sides. I then drew on the body shape from my body template and this gave me an idea of how much rosewood I had left at the edges of the upper bout area to remove for making a bookmatched headstock veneer. I tried to leave enough to have about 5mm extra all round the body shape. I then marked on my cut line for the headstock material using masking tape.*

# Thickening of back

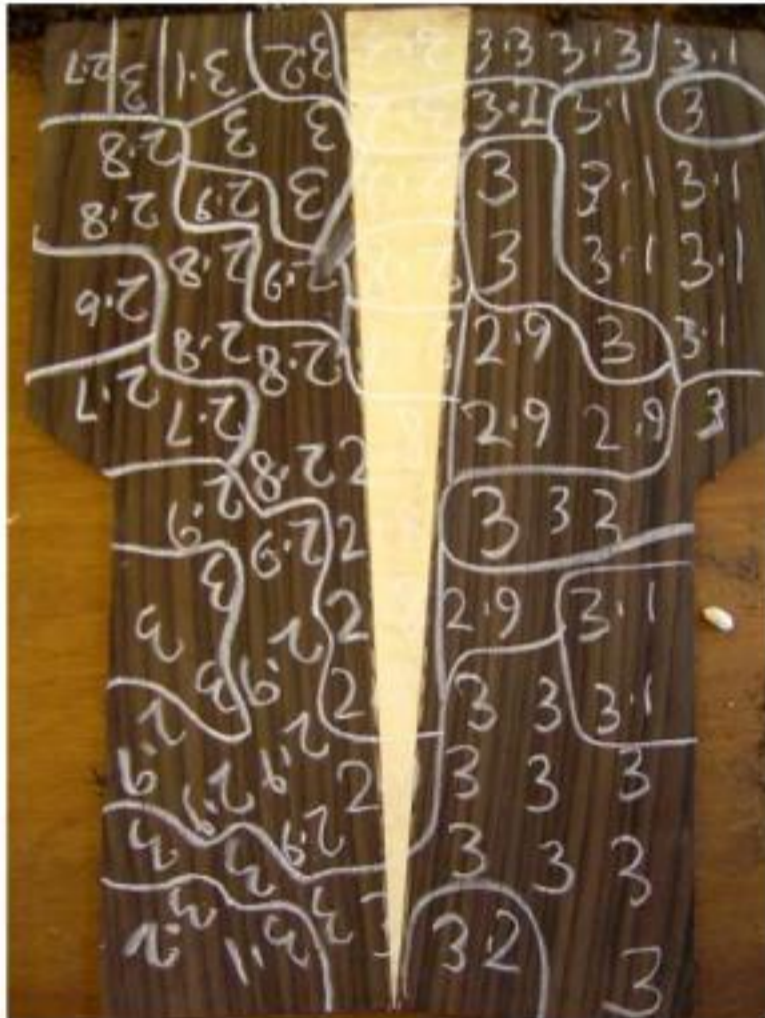

*Completed back thickness / weights & frequencies*

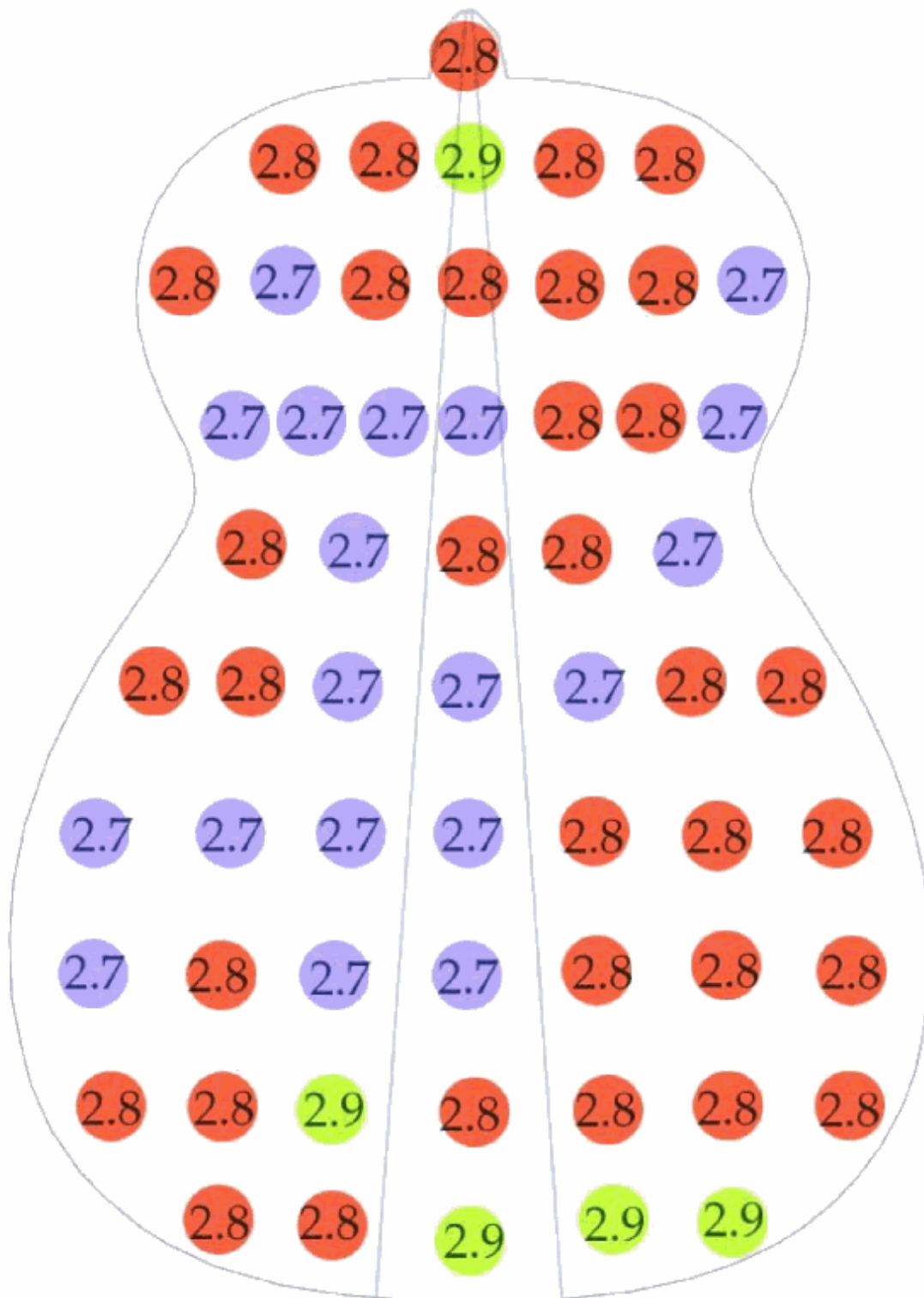

## *Guitar neck*

## Routing out channel in neck for truss rod

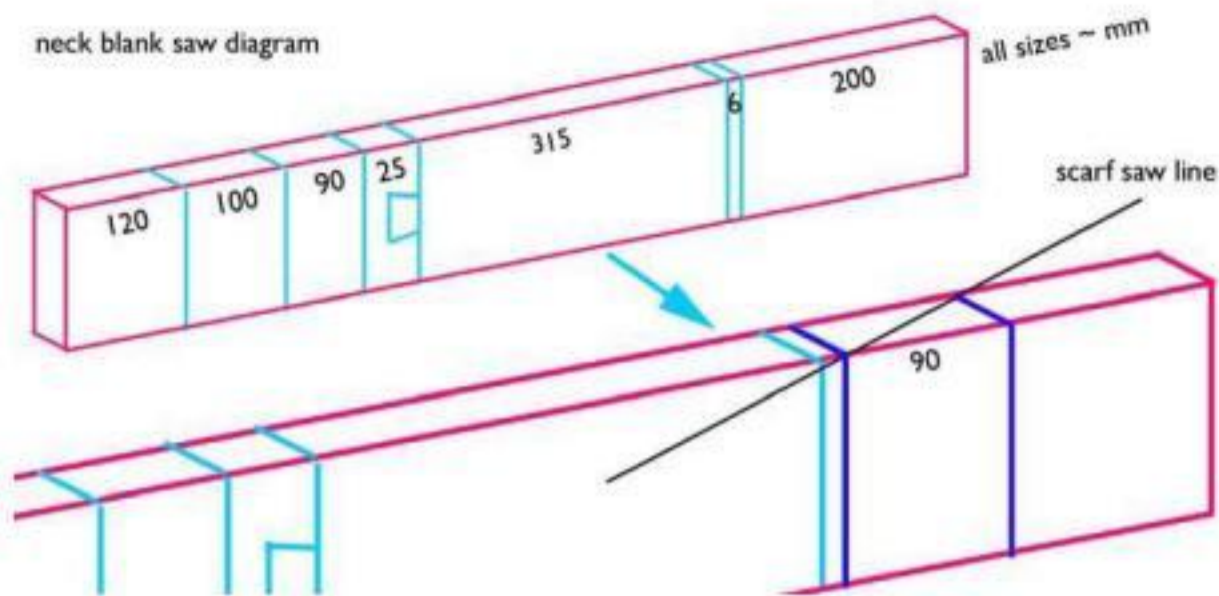

As well as the 120, 100 and 90mm block shown here in the diagram to be cut out for the heel block, there was also another 90mm mahogany block to be added onto the bottom of the heel. This had been cut off the end of the neck blank initially as it had a big slope on it but was fine to be added last for the final tip of the heel.

Having gotten the steel string neck to pretty much the same stage as the I did classical neck last year, I then had to make the truss rod slot using the router. The router depth had to be set to 12mm and this was allowing 10mm square for the truss rod itself and a further 2mm for a truss rod cover made from wood.



I drew a centre line on the guitar neck making sure by clamping the ruler all the way down the length. I then set the router up with its edge guide and set the depth stop for 12mm I tested this by checking along the side of the neck and measuring down trying to judge where the cutter bit bottom edge was.



I made sure I had an end stop in place to make sure that the router would stop about 5mm short of where the the nut will be. Before starting I made sure that the neck was firmly clamped in place in the bench vice and was also securely supported underneath the back of the neck where I would be putting pressure with the router. Important here is a dust mask, goggles and someone to help vacuum up the dust while routing. Even pressure with the router guide along the edge of the guitar neck helped keep the routed out channel mostly consistently straight - there was a slight wobble at the dovetail end but think overall it was a good attempt. Important again here was to make sure router was unplugged and switched off and the bit had stopped turning before removing from the neck. Once routed out I checked channel depth and found it was 13mm! This means I will have to make sure neck thickness stays at least 1mm thicker all round than would normally have been. Next time perhaps a trial on a scrap piece of wood and a check of depth with router before going onto real neck would be a better safeguard than routing too deep. After this I chiseled the end of the slot at the nut square using a quarter inch chisel ~ this is to accomodate the squared end of the truss rod.



## Marking out the neck angle and preparing to cut the dovetail

With the truss rod slot cut out I was then able to move onto marking out the dovetail. I rechecked all my centre lines to make sure that they were still correct. First I marked on where the 14th fret body join would be and marked this using the try square for accuracy. I followed this line down the sides of the heel block and also along the bottom of the heel block. At this stage I marked 1mm back from the squared line on the opposite side of the line to where the dovetail will be. This change in angle by 1mm at the bottom of the heel block gives the slight 'tipped back' angle that helps compensate (in conjunction with the truss rod) for the extreme tension of the steel strings once fitted.



With this angle now marked on, I then used the sliding bevel to duplicate this angle onto the other side and also onto both sides of the 20mm dovetail section. After this was marked up I was able to cut most of the excess away using the band saw and followed this up by block planing away the end grain right up to the line I made for where the dovetail should end. I made sure to plane into the centre of the block and come at it from all 4 sides to avoid splitting the grain. While doing this I kept checking and re-checking the neck angle using the try square to assess whether the angle was still 1mm or if it had gotten more like 2mm. Gradually after a bit of time I managed to get the area planed flat and as close to the line and as close to the 1mm neck angle as I could manage. Next will be marking out the dovetail and cutting it out.



## Marking out dovetail on neck and beginning cutting



Firstly I began by extending the neck centre line down the face and along the bottom of the heel. I then began drawing on the measurements as shown in the line drawing below. When I had the sloping line drawn for

one side I was able to use the sliding bevel to mirror this on the other side. This was a good thing to do as when I had done it I could see something was not correct as regards my centre line and so I had to do a bit of an examination to see how I had centered it. In the end realised I had been about 1mm out with my centre line and re-drew this. Also because there had been maybe 3 weeks since I had last worked on the heel I had forgotten that I had taken about 5 mm off one side of the heel block in an attempt to level it with the individual blocks so having a re-think at this point made me remember that and not to just centre my dovetail on the end face which would not have been correct. Once I had sorted it out I then re-drew all my dimensions again and used the sliding bevel to

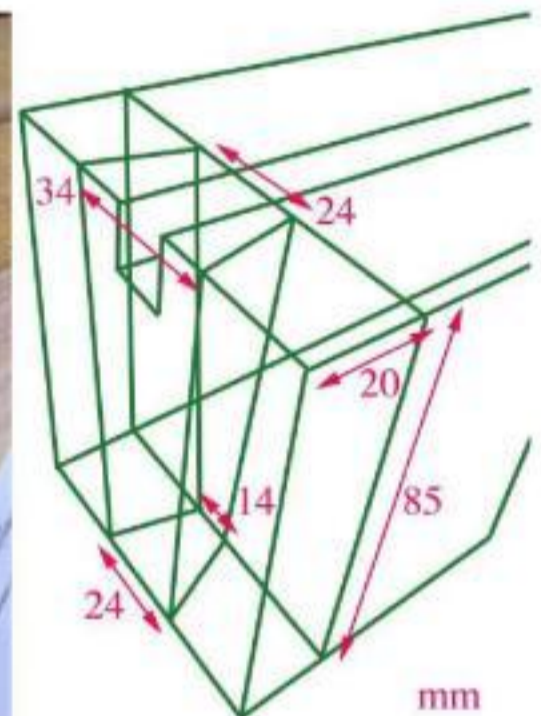

double check. With everything looking good I then set out to make my first two sawcuts for the dovetail. I clamped the neck at the heel block into the bench vice and set the cut upright using the engineers square to make sure it was completely vertical. I then started off the sawcut with a dovetail saw a good 1.5 mm clear of the pencil line. This was to allow the tenon saw, which cuts a thicker kerf, room to settle into the thinner initial cut. After this process for second cut. Both went reasonably well though they were not completely mirrored. Next I drew on the

rib curve lines on the top surface of the neck using the body template and extended this down the sides at the same angle as is needed for the steel string neck angle. These new lines down the side will be my cut lines for the next two sawcuts.

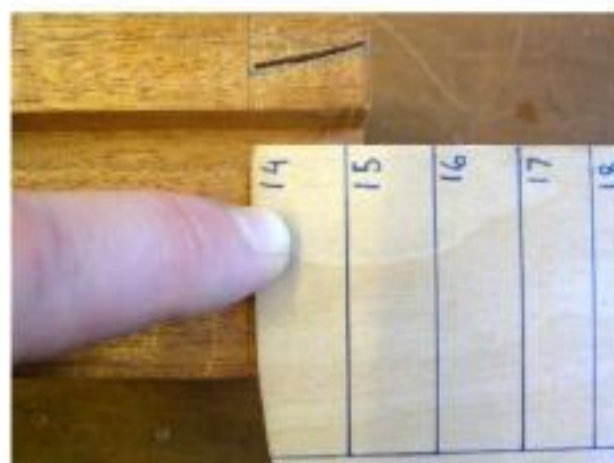

## Next two saw cuts with rib curve angle

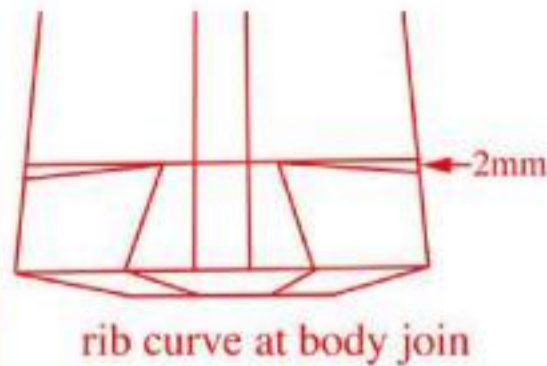

With the 2 cut lines drawn down the side and drawn on the top sloping back towards the original line, it was now time to make the second set of cuts. Again I started off with the dovetail saw to begin with then moved onto the tenon saw for the rest of sawcut. This worked quite well though because of the angle at

bottom of saw cut, I went a little deep (about 3mm) at the thicker side of the dovetail.

When these were both done I set about cleaning up the 4 cut faces of the joint using a 3/4 inch firmer for working closely in towards the dovetail and with a 1/2 inch paring bevel chisel for chiselling along the length of the tenon faces. Initially I was trying to just take away any bumpy areas and tidy up any roughness left



by the saw cuts. At this point George suggested taking the 2 offcuts from the dovetail and doublesiding some 240 grit sandpaper to them and using them to equal out the shape of the tenon. Realised if I just used the one sanding block then I was able to use it to match the other side by comparing it and then cutting away what was needed until I had gotten both sides

close enough a match with the chisel, that I was then able to move onto using the sanding block itself (see image at bottom for explanation of how I was using the offcut sanding block to mirror the 'cheeks'). This took a bit of time to get right and inevitably the dovetail was slightly reduced in size from the original target dimensions. It was only a matter of a couple of mm less however so it should not affect the stability or strength of the joint. The original 'hoped for'



dimensions are still good to keep on the plan as there more than likely will always be some variations when cutting this joint.





*Dovetail and heel block fitting diagram*

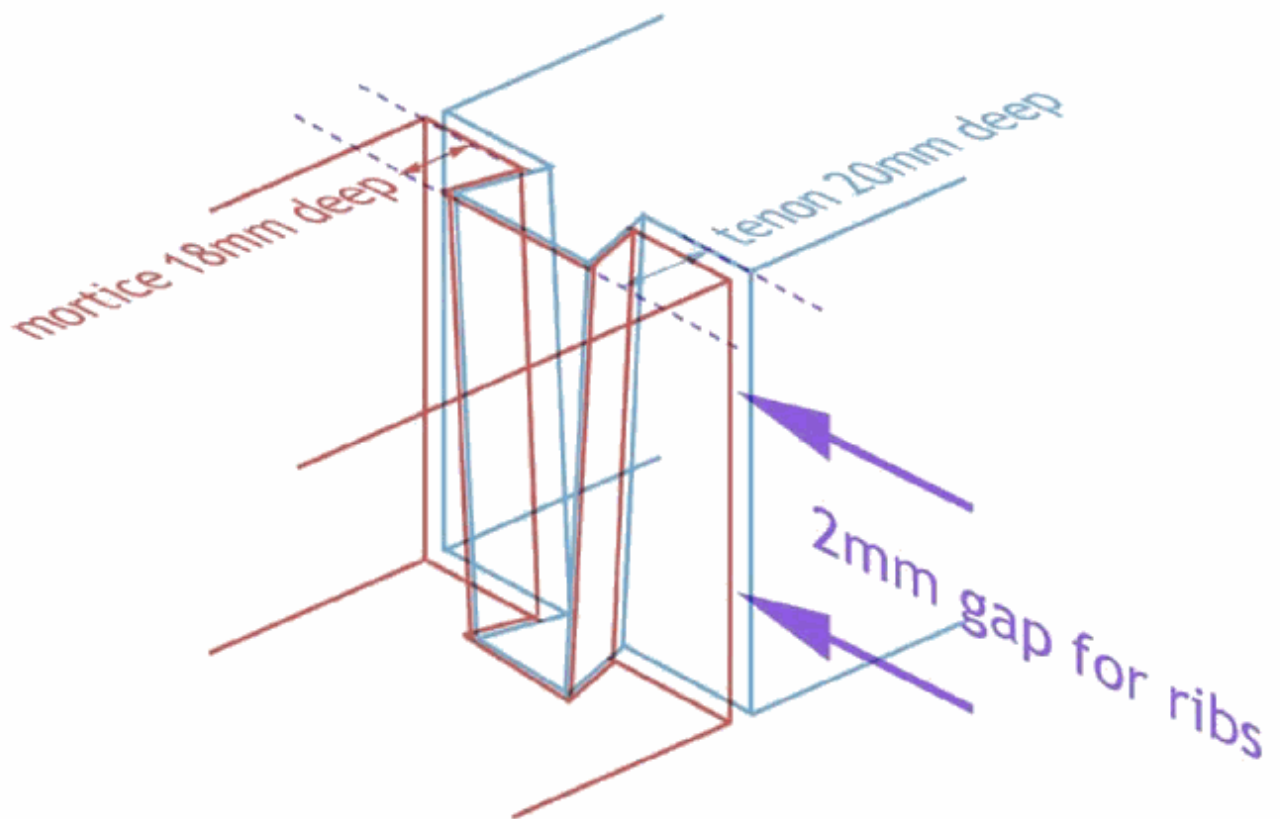

## Making the heel block for neck dovetail tenon to fit into



The block for the body that the neck fits into is left at 95mm high just to provide a little extra material for when the block will be shaped to fit the soundboard and back curves. Firstly I took the mahogany block and started to block plane one face until completely square in all directions. Next I did the same to the top and bottom face which will be glued to the soundboard and back. I checked each face was square with the first face. Once this was done I squared off the 2 side areas until the block was about 70mm wide - these are not as important as there will be nothing glued to the two sides. Once this was done I pencilled in all the measurements as shown on right taking into account that there will be 2mm less in the mortice to account for the 2mm rib thickness sandwiched inbetween block mortice and neck tenon.



Next I block planed the main face of the dovetail block where the ribs will be glued onto. To check the curve needed I had to continually compare the block

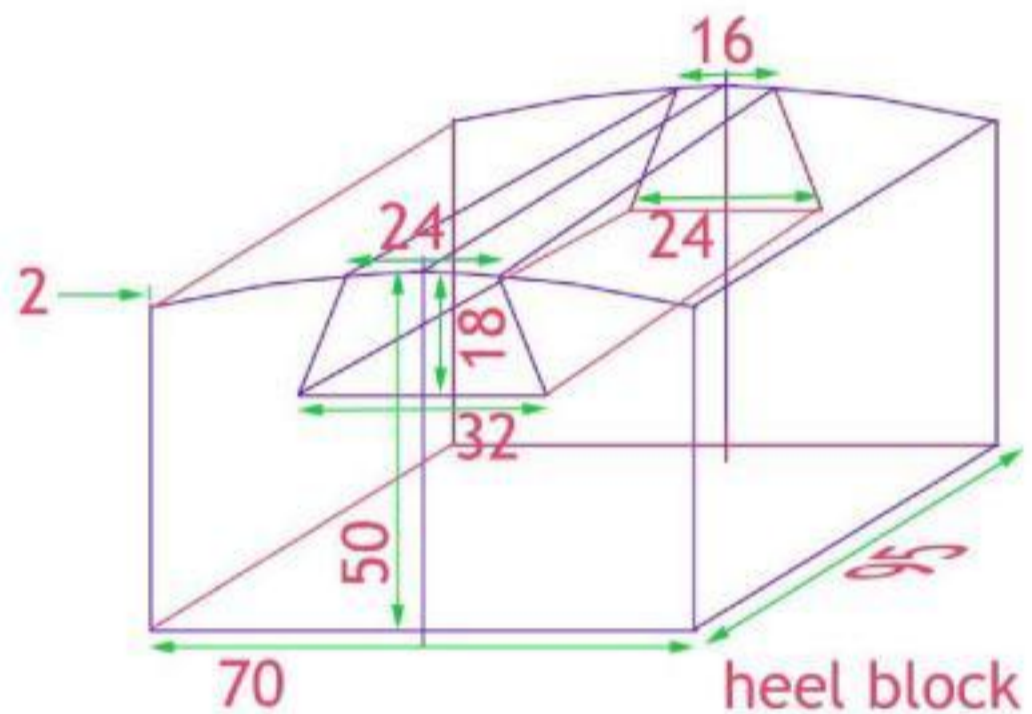

with the area where it will be glued on the the fully cut out soundboard to get an exact match. This is important as the ribs need to fit flush with the block when clamping together and any error in the shape of the block could result in a rib being out of alignment. Also here I used the small engineers square to check that it was sitting level on the soundboard. This will change later when the soundboard is on the solera but for now it had to be square on a flat workboard. This took a bit of time but finally I managed to get the block fitting to the curve as shown (below right).

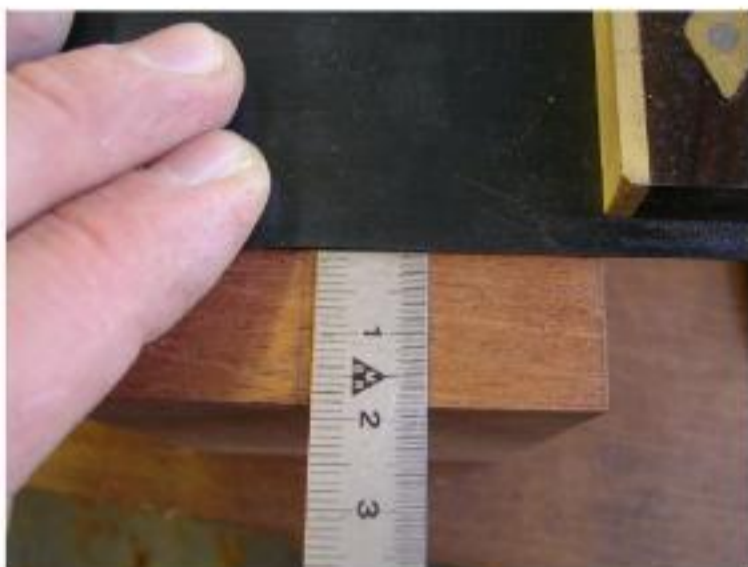

## Cutting out mortice and tidying up



Today cut the two slots needed for the dovetail using both saws as described before. I went a bit deep with the cuts but maybe wasn't concentrating too well on it today. When I got close to the bottom of the dovetail I checked it with the tenon on the neck to see how it was fitting and this helped me get the dovetail mortice flatter from end to end. I also used the try square regularly to make sure of this too.



To get the block a bit more even and flatter I made up a sanding stick made from one of the two offcuts from the dovetail tenon. I kept the one offcut / sanding stick I had used to sand the tenon later but used the other one for this job. Had to readjust the angle of the sanding stick a bit to match the shape of the mortice. Used it to further smooth out the mortice. Once this was done the dovetail on the neck itself seemed to fit quite well to about half way down so don't need to do any further fitting of the adjoining areas until the neck fitting when the body is all together.

## Bookmatching headstock veneer & inlaying herringbone



I decided since I was making a classical style slotted headstock that I would like to use some of the rope purfling as a herringbone centre strip between the two bookmatched pieces for the headstock veneer. I had 2 pieces leftover from the back join which were plenty long enough so matched these together with a central white line. I made a rough headstock template that is 40 wide and 185mm long and used this as a guide for how big to make the 2 pieces either side of the herringbone. I squared off the edges of these using the shooting board using the same method as for the soundboard and back join and tested my template over the herringbone to make sure the pattern of it was going to work out correctly. To glue them together I set up a small mdf board covered in double sided with the backing left on and two mdf blocks either side of the headstock veneer which stick out slightly either side of the bottom board so that the 2 sash clamps (on which the whole set was resting) can be tightened. In order to raise the 2 rosewood pieces a little from the bottom board I placed 2 layers of thin marine ply underneath each side. This is so the herringbone will inlay a little deeper than the surface and give ample extra to plane back flush afterwards.

The next day I unclamped the whole set up and began block planing down the herringbone on both sides. I also tried to plane the whole piece a little thinner as it was still about 4 - 5mm thick. Every so often I checked the squareness of the surface to be glued. I then used the cabinet scraper to get the whole piece a bit finer.



After this I took the 3 ply black, white, blue veneers I had already glued up and planed one edge and got this piece and the headstock veneer to 180 x 80mm which was the size of the actual headstock area on the neck.

## Gluing up headstock veneers

Once I had both pieces the same size I had two options for gluing them up. Either I could lay all pieces on their side edge for gluing up (this would mean that the herringbone would be aligned from resting on this edge) or I could use two 1.5mm drill bits as guide rods to position the headstock veneer accurately in the centre of the neck. Having prepared the pieces either way I decided to just go for the method with the 2 drill bits as this seemed good



enough. I positioned the 2 sections of veneer over the neck and once I was happy that it was centred I clamped everything up using 2 inch thick full length and width clamping cauls for under and over the headstock. The caul on the back I chamfered a little so it would extend a bit further onto the neck. With everything clamped in place I drilled in the guiding pins into diagonally opposite corners in areas I knew would eventually be cut off. Once these were in I unclamped everything and checked how centred the herringbone was. It seemed fine so I disassembled the whole setup and prepared to glue everything up.

I got 6 G clamps ready and the 2 cauls and removed the drill bits. Next I began applying titebond glue and spreading evenly on the two veneer surfaces to be glued. Once the glue was spread I aligned the two pieces making

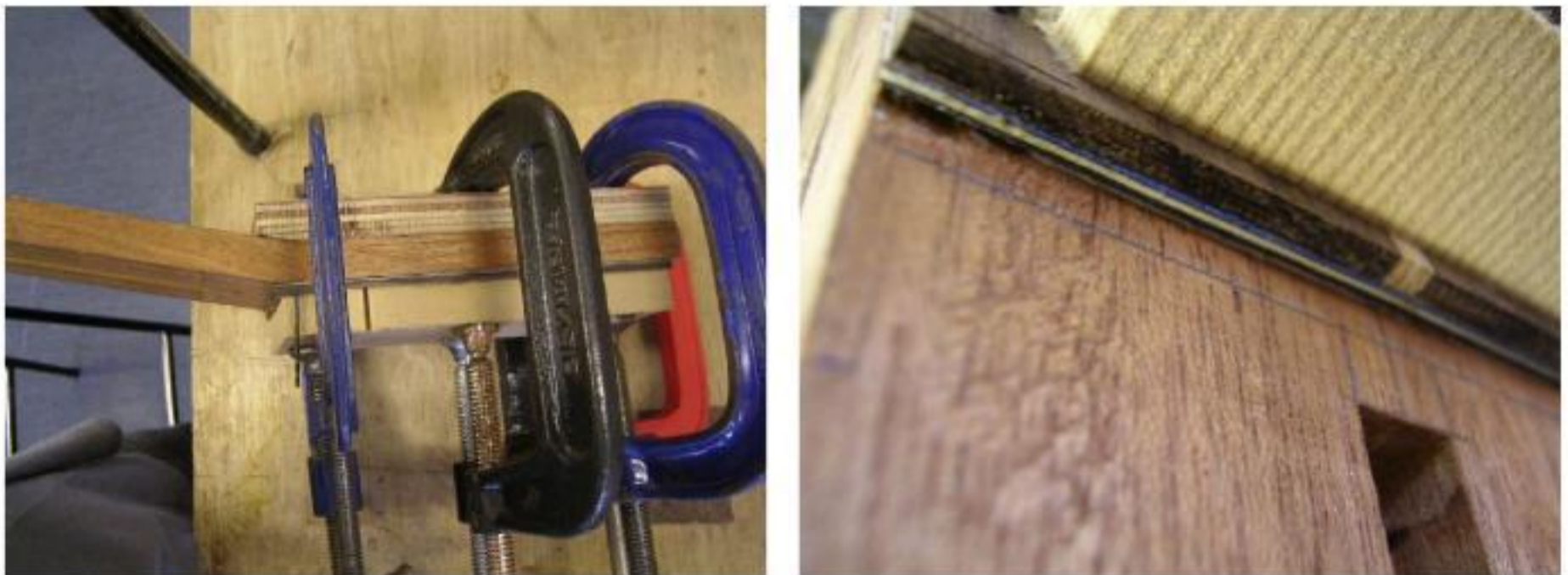

sure that the blue veneer would be facing up the way next to the rosewood. I placed the 2 drill bits into the veneers and then aligned them into position onto the actual headstock. After this I put the cauls in place and clamped up the whole assembly tightly while also keeping an eye on the centre line. I cleaned off the excess glue and left for a couple of days to dry fully.

*Plane shavings from headstock herringbone*



*Final headstock shape*

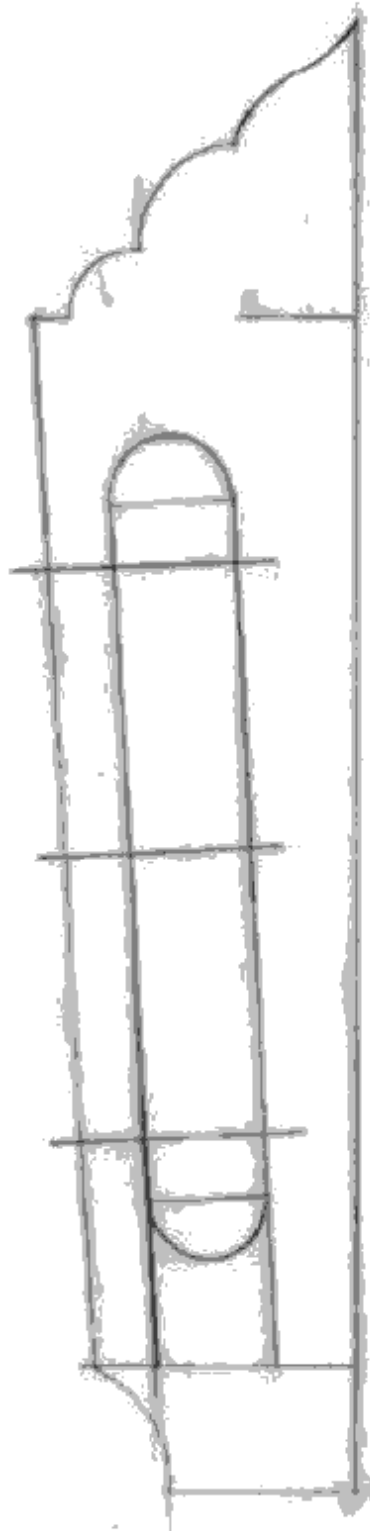

*Some images of work on headstock & neck*

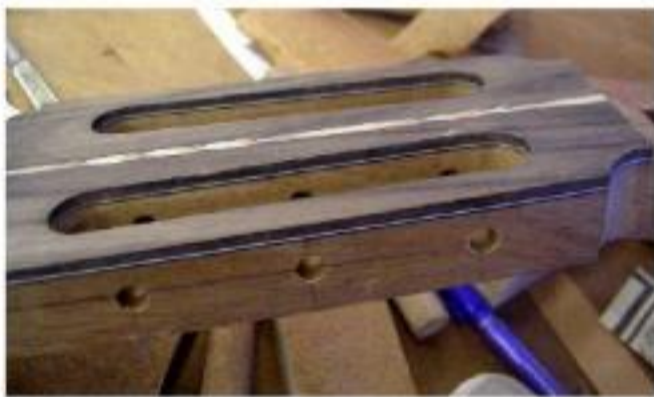



## *Assembling the Guitar Body*

*Splitting a side!*



## What happened?



Jan 31st: Split one of ribs from lower bout end along it's length to almost the waist. Was trying to get one of the ribs bent a bit more towards the soundboard shape and also to make sure the ribs would glue onto the curved faces of the end and heel blocks. In the process was trying to bend out some of the cupping to see if that would help but that was when it cracked. Repaired with titebond and spoolclamps on alternating sides of rib.



Feb 1st: Compared repaired rib to soundboard shape and then re-bent again but from upper bout end to avoid glued crack - got both ribs closer than before but got a bit bogged down by all clamping possibilities and spent most of the day adding more and more big and bigger clamps and cauls to the whole assembly until it just didn't seem likely I could get the whole thing clamped on my own! The kerfed clamping blocks Paul suggested to me and which I made (top right) didn't turn out for me as hoped - the curve was not completely accurate to the shape of the end and dovetail blocks on the soundboard. Stopping and giving the task some thought I decided to risk it and go with the original way I had set up to test how the ribs were fitting the blocks. This was just 2 small rectangles of 8mm plywood used as cauls on the rib edges being glued outside with pine cauls on inside edges. With plenty clamps nearby I just decided to go for it as I figured



(later on) that the two surfaces to be glued are not that big and the best way to join them is to get the pressure focused on that small area while the glues is setting. To get the pressure focused it seemed sensible to not clamp up as much as had previously and surprisingly the surfaces seemed to bond together well enough.

Cleaned off glue and will do other (cracked rib) tomorrow hopefully. That will be test of end block alignment.

*Final one at a time rib clamping solution*

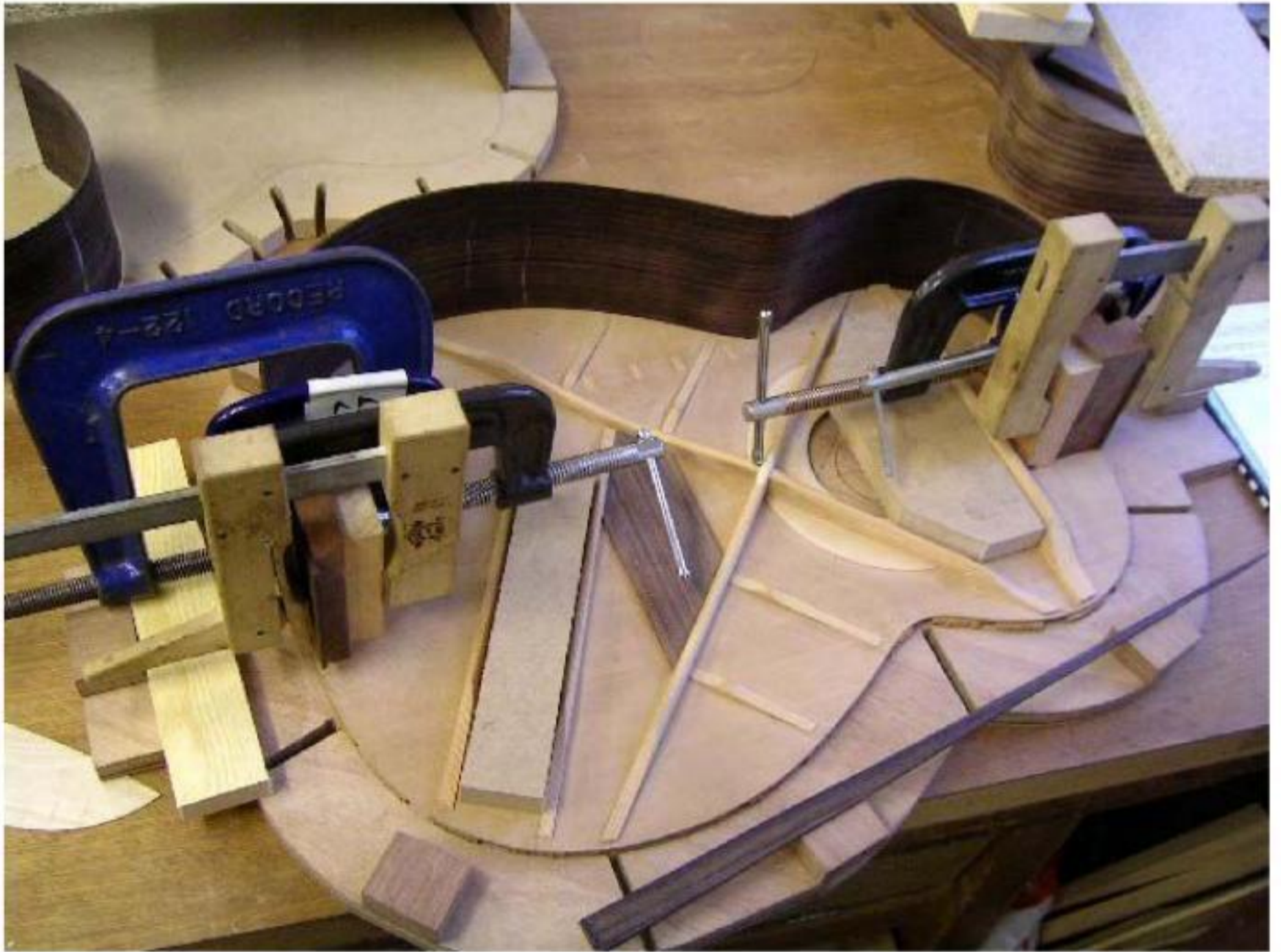

*Gluing tantalons, planing ribs & gluing linings*

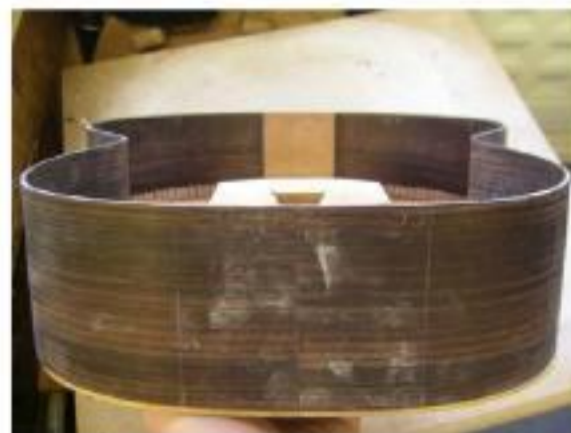
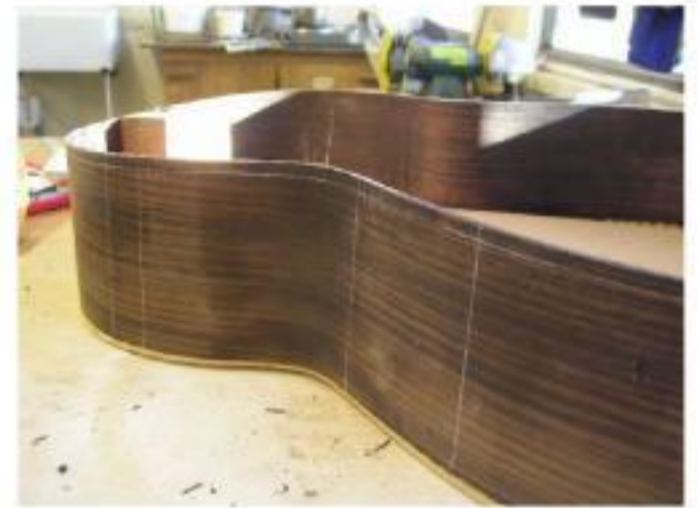
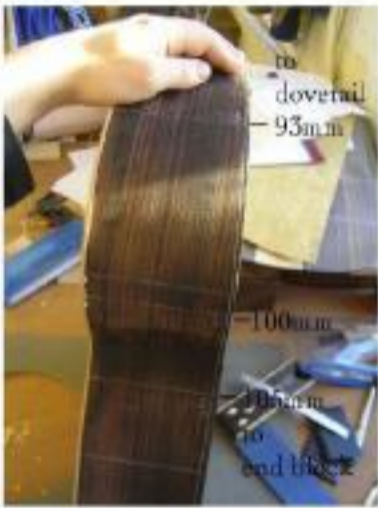
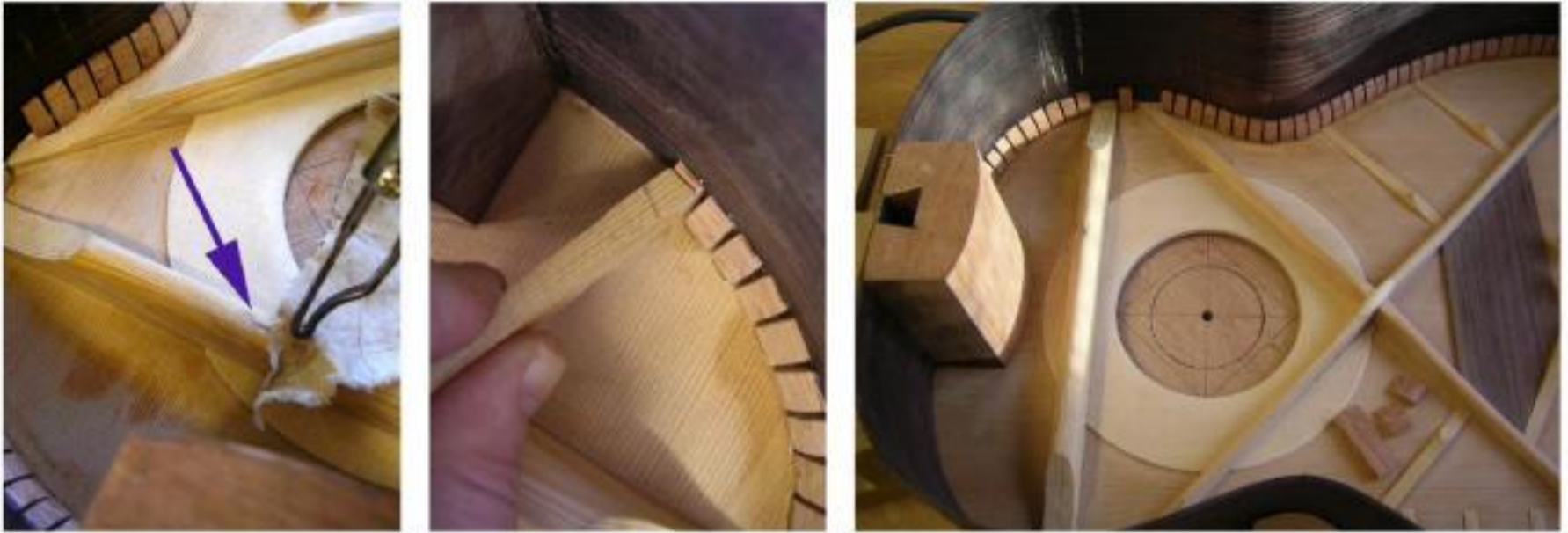

*Bracing cracked rib, bracing back and preparing to glue back on*

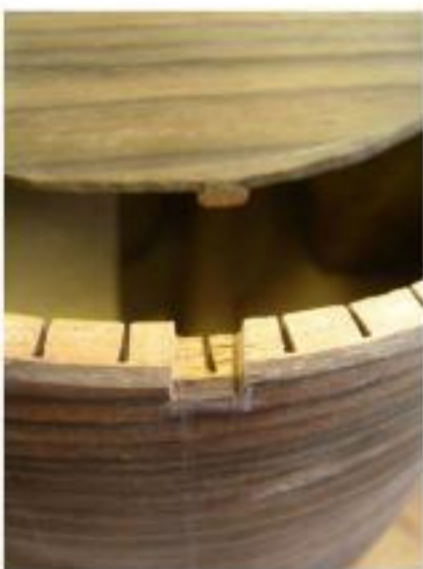

*Ready to glue back*



*Gluing back / cleaning soundboard and sealing with animal glue*





# End graft ideas 1

end graft line drawing.jpg

1.

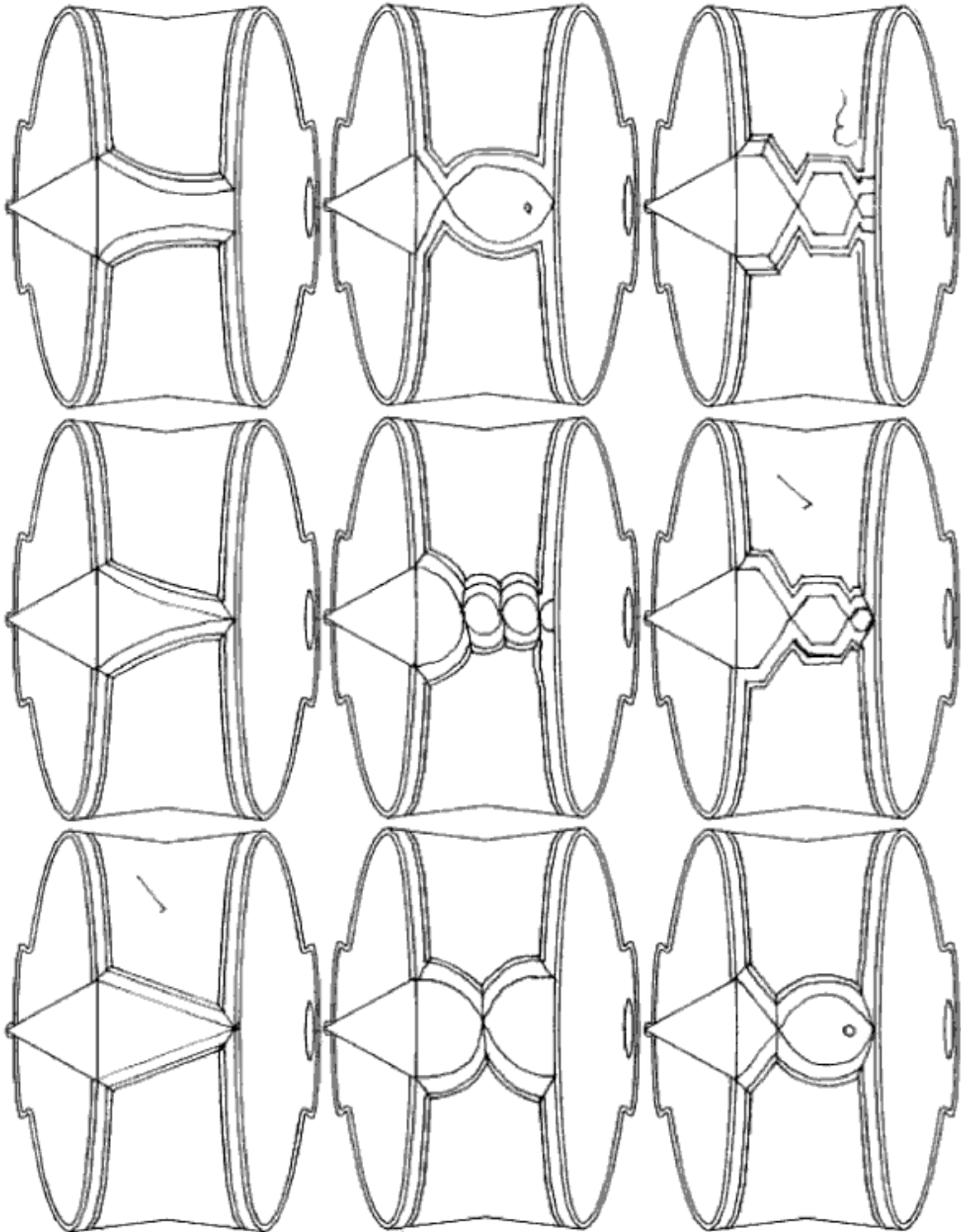

## End graft ideas 2

end graft line drawing.jpg

2.

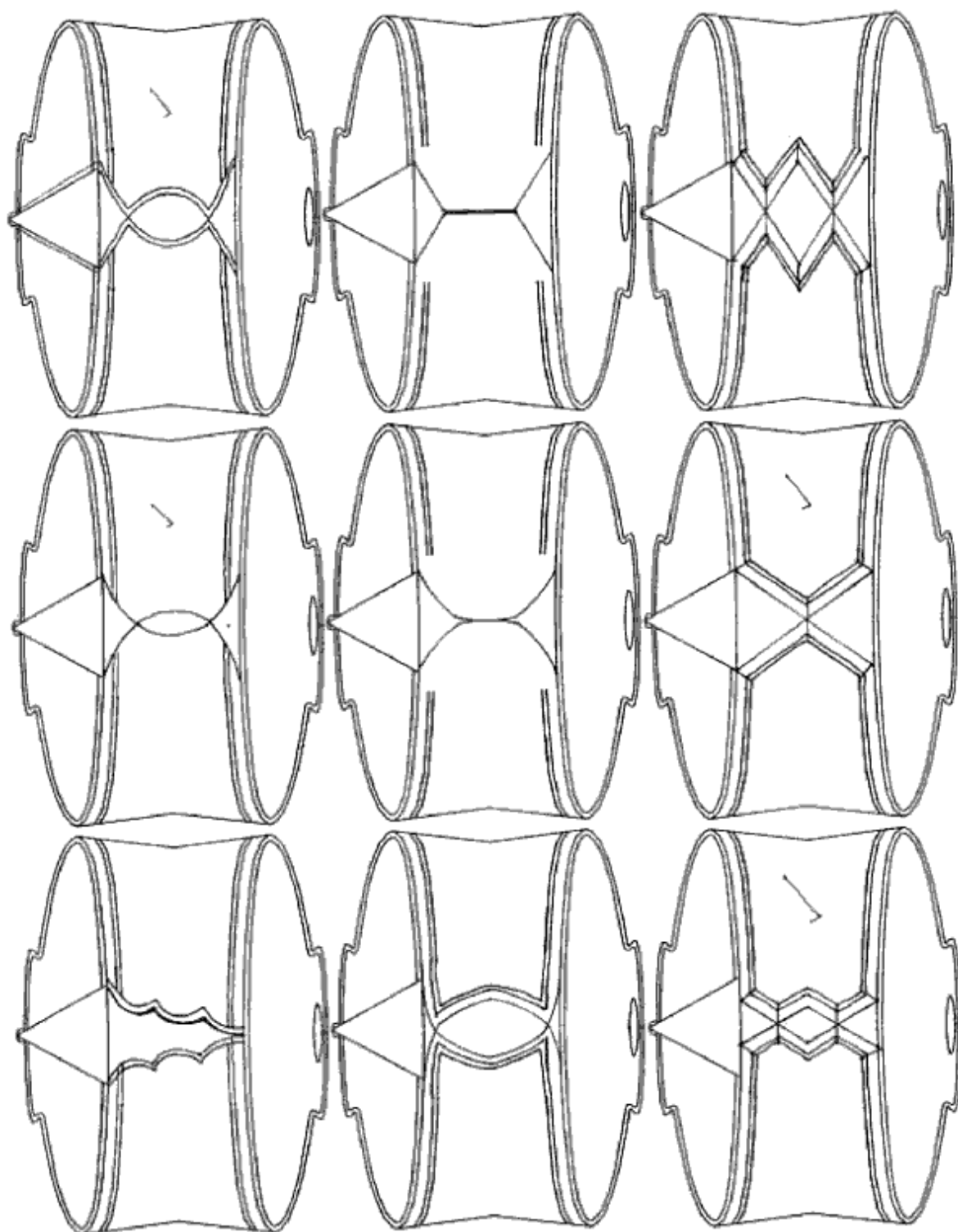

504

# End graft ideas 3

end graft line drawing.jpg

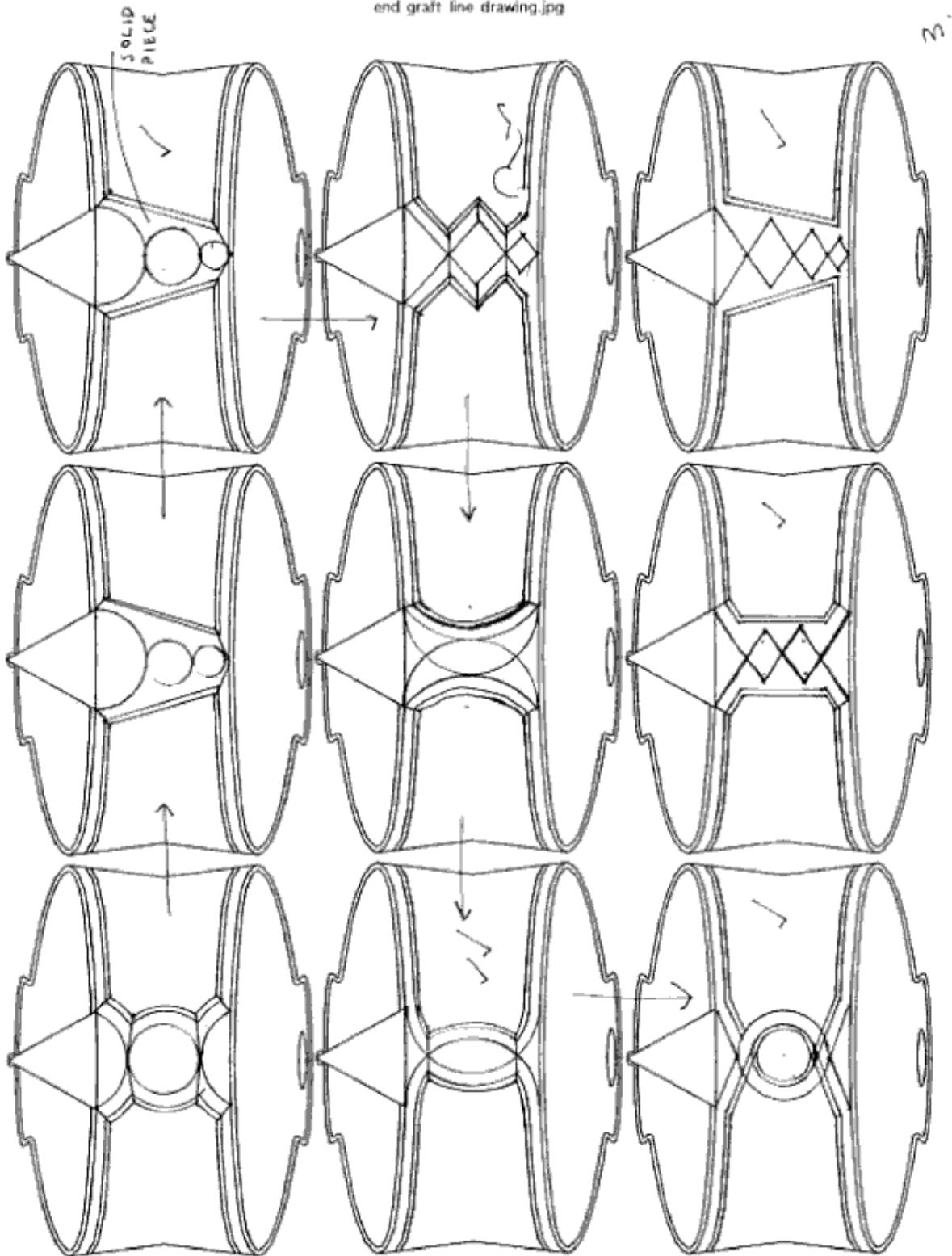

# End graft ideas 4

end graft line drawing.jpg

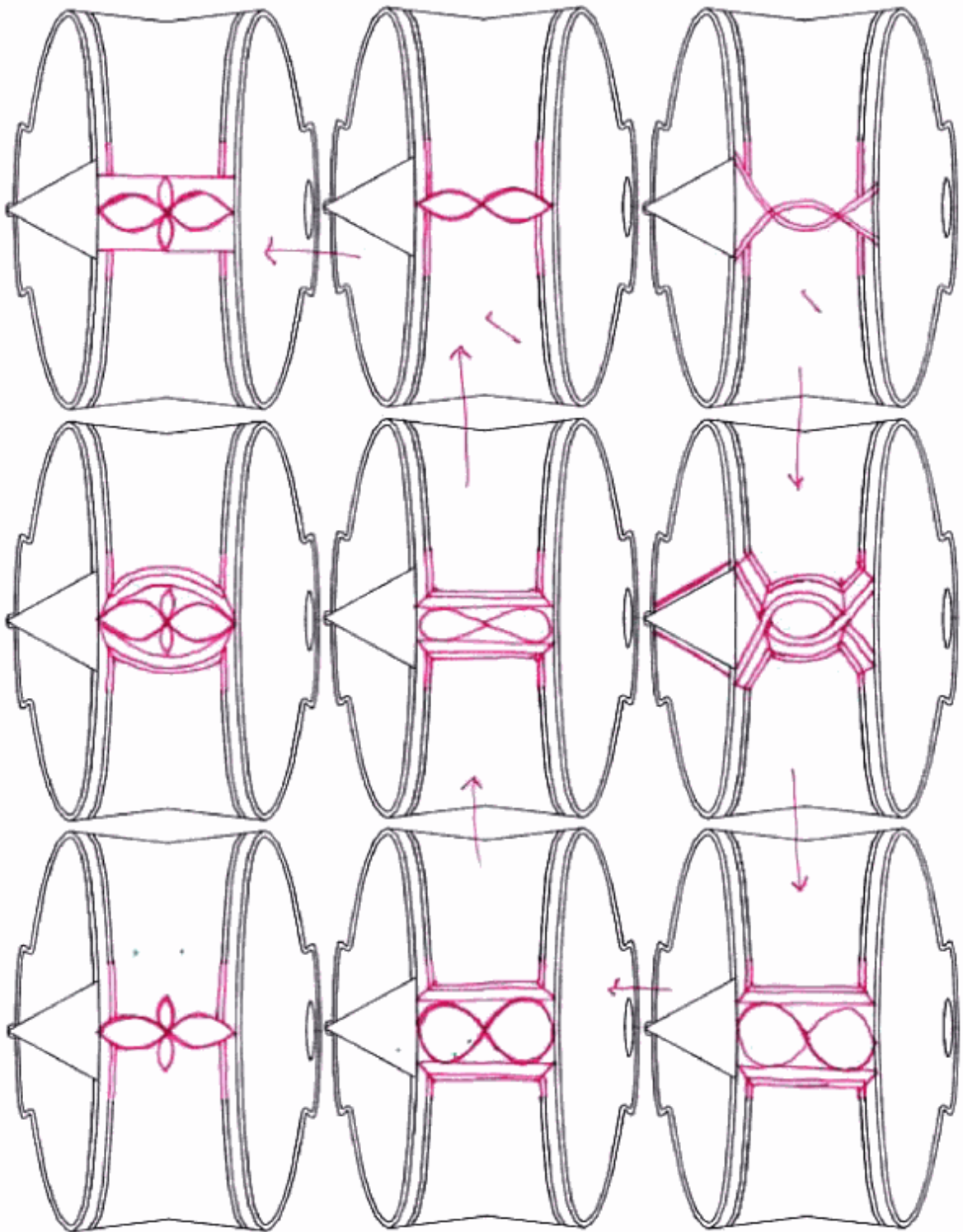

8.

*Design I liked most from sketches*

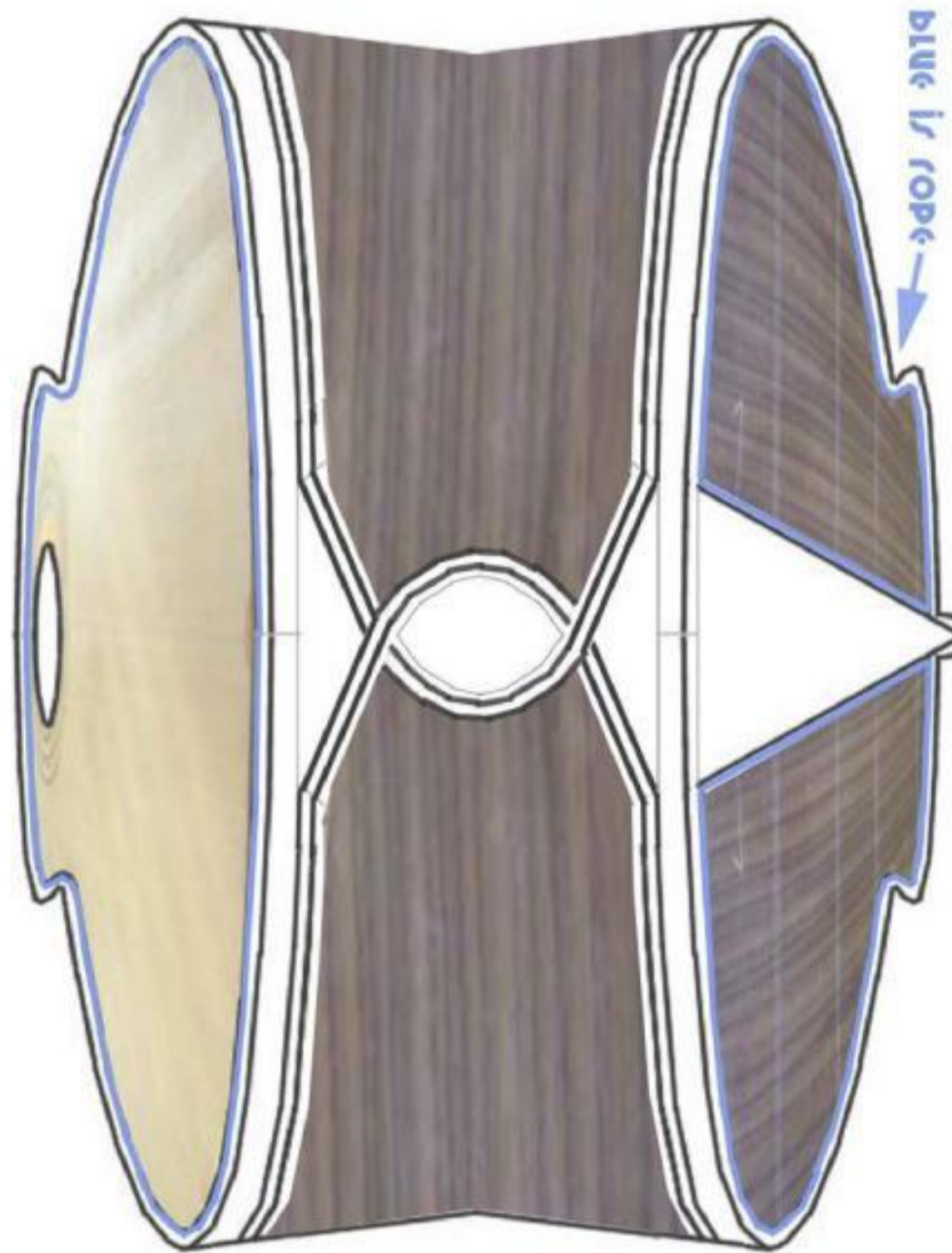

*Did this drawing on the computer to try to visualise it a bit clearer. This was the one I was going to go with but when I made this image up I realised what Paul was saying about the veneer strips from the binding becoming reversed at the crossover to black against rosewood and white against the central oval shape so decided to abandon this and sketch a bit more.*

Final design 1

FINAL DESIGN

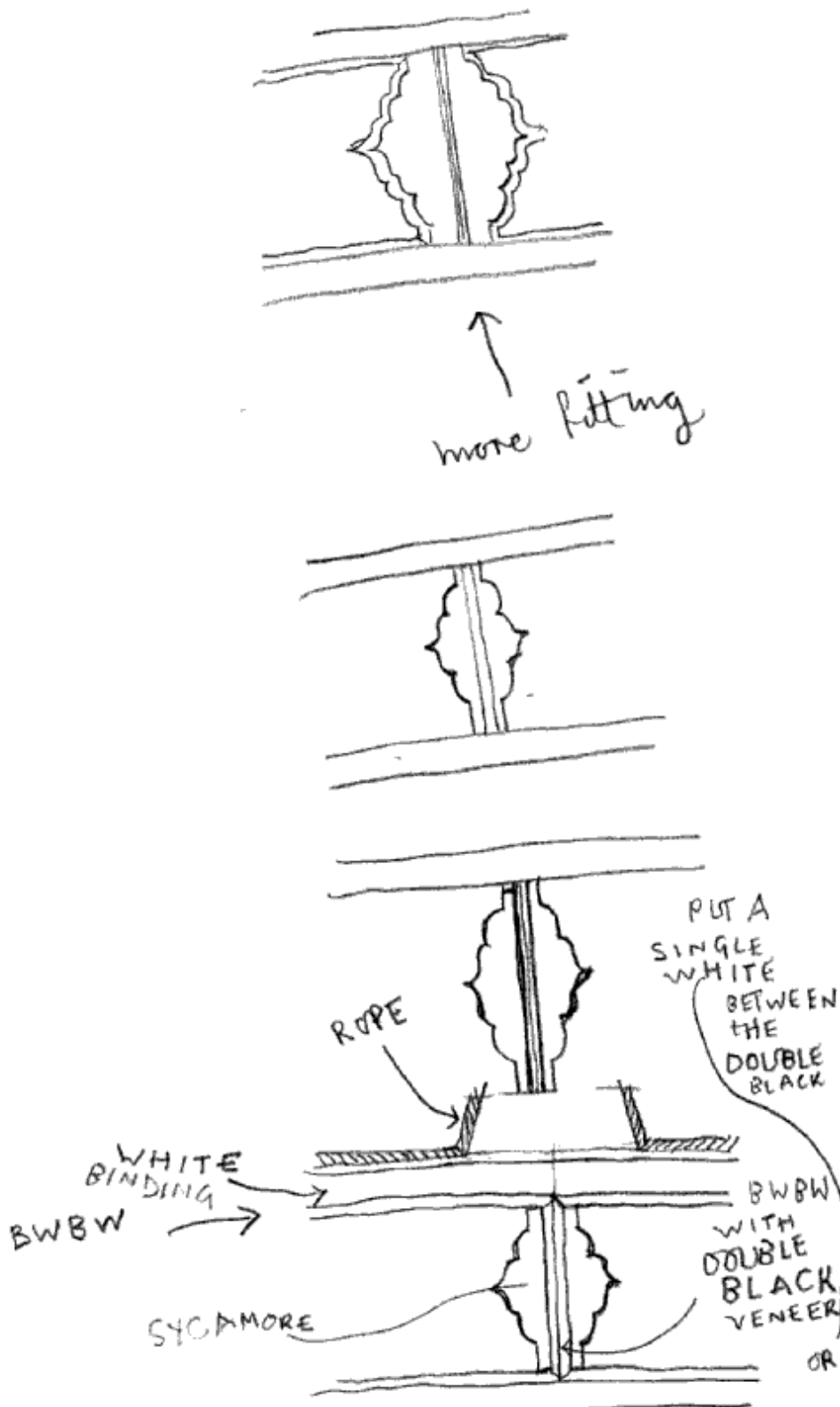

Had decided on a design for the end graft from the previous worksheets but then realised it wasn't going to work out. Did some drawings more based on the islamic design of the guitar headstock and bridge design and thought this idea was much better in the end so going to go with this.

Final design drawing

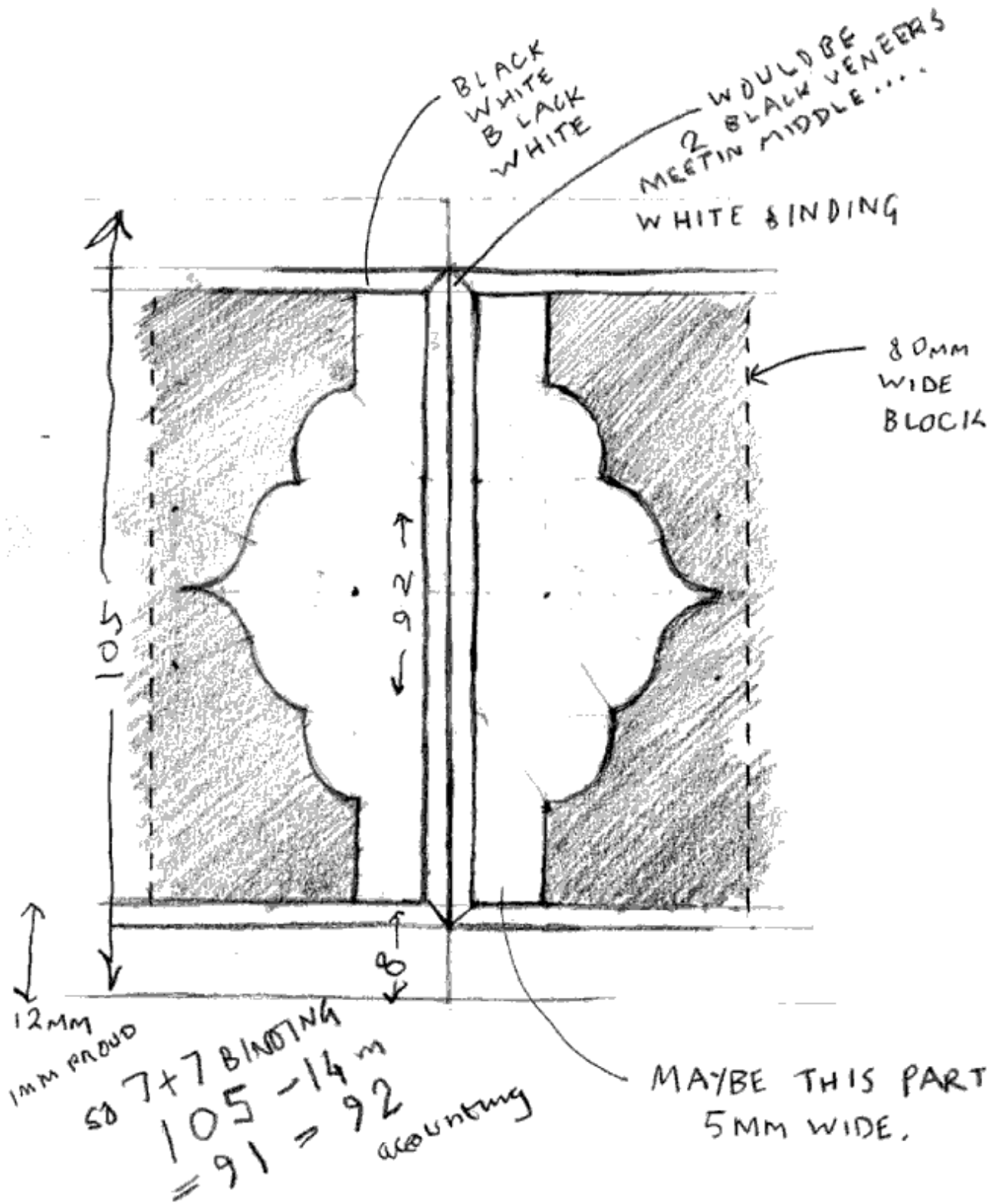

## End graft

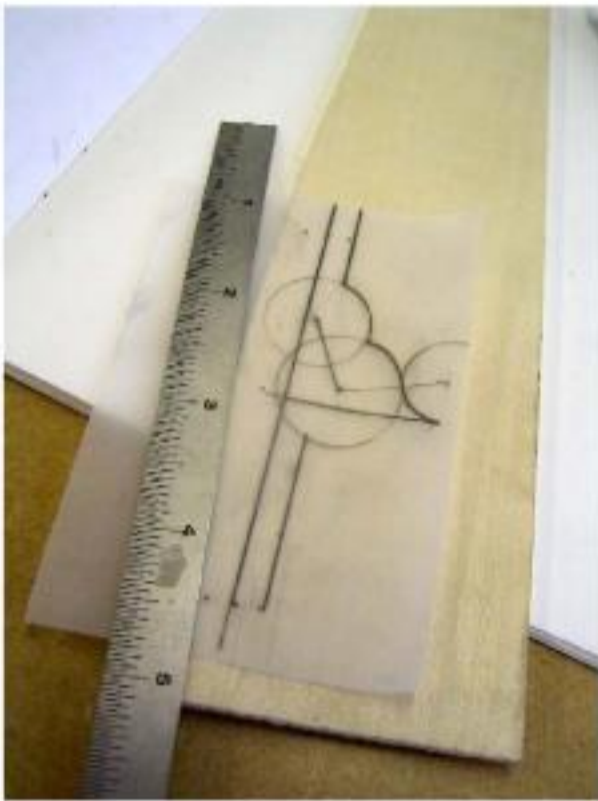

Feb 27th: Today just took sketch and traced it onto the piece of sycamore and then superglued this piece and another piece together tacked with a few pinhead sized spots of glue. This was enough to allow me to bandsaw the rough shape of the design out twice. Keeping them still glued I then shaped them using chisels and smaller gouges much the same way as i done



the headstock in the vice. Once the ornate shaped part was done I then planed the bottom edge with a block plane according to the design. Tony had a look and said he liked the pieces this way round (2nd photo). Took the 2 pieces of the end graft and placed the veneers inbetween that will make up the central strip which comes off the lines of the putrfling. Measured the whole thing against guitar and decided on the length the graft needed to be accounting for the width of two 8mm bindings with 1mm subtracted off each 8mm width to allow the binding to stand proud of guitar body edge. - so it worked out 105mm (length top to back) minus the 2 x 7mm (bindings). Also to be accounted for was that at the point the binding meets the end graft, the very edge white veneer of the binding will stop short to allow the black veneer line to be the edge that meets the white sycamore of the graft. To

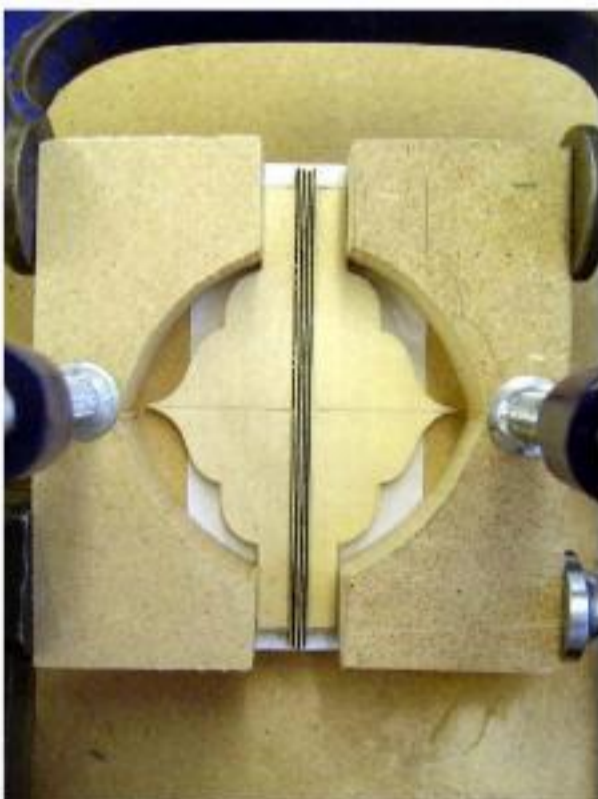

account for this I added 1mm back to length for two pieces of graft! Cut two pieces to size and then put in the 7 'BWBWBWB' veneers (an extra white in middle to keep design matching sequence in binding). I left these maybe 4mm proud either end of two graft halves to allow for mitre join. I then tacked this in place with 4 dots of superglue to the guitar in preperation for scalpeling outline onto rosewood of guitar.





## Cutting out shape of graft on ribs and gluing

Feb 28th & Mar 1st: Using a sharp white pencil traced shape of end graft onto rosewood. Carefully lifted off the piece and then, using a scalpel, carefully scored just on the inside of this line by about half a mm. Safety glasses



here are good as snapped about 10 scalpel blades during the process. Could only score in about 1 to 2 mm so then began to chisel away near the center with a quarter inch chisel trying to remove the bulk of the area as thought maybe then the edges would be freer for scalpelling deeper. This worked well though Bill suggested just using the scalpel to cut away and found this was better than the chisel. Once I had removed quite a lot of the bulk of the



rosewood, I then was able to re-score the outside line again and take it deeper. This process was repeated until I got down to the mahogany of the block. Here I found the chisel useful to just remove the last remaining bits of rosewood and dried glue. I then scraped the area clean using the chisel as a scraper. Made area on guitar deliberately a bit smaller to allow me to have extra material on the shape for fitting. On March 1st I used a gouge chisel to trim the side walls of the graft area on guitar to allow the graft to sit into it better. The gouge



helped on the curved areas. Gradually I got it fitting though needed to make a clamping caul as shown above to apply extra pressure on the two side points and top and bottom due to the rounded shape of the end of the guitar. After this did a dry run with clamping caul and when happy I glued up with titebond with stanley strap clamp. Next day I block planed graft flush with ribs.

*Graft complete*



## *Recutting dovetail, front purfling + binding*

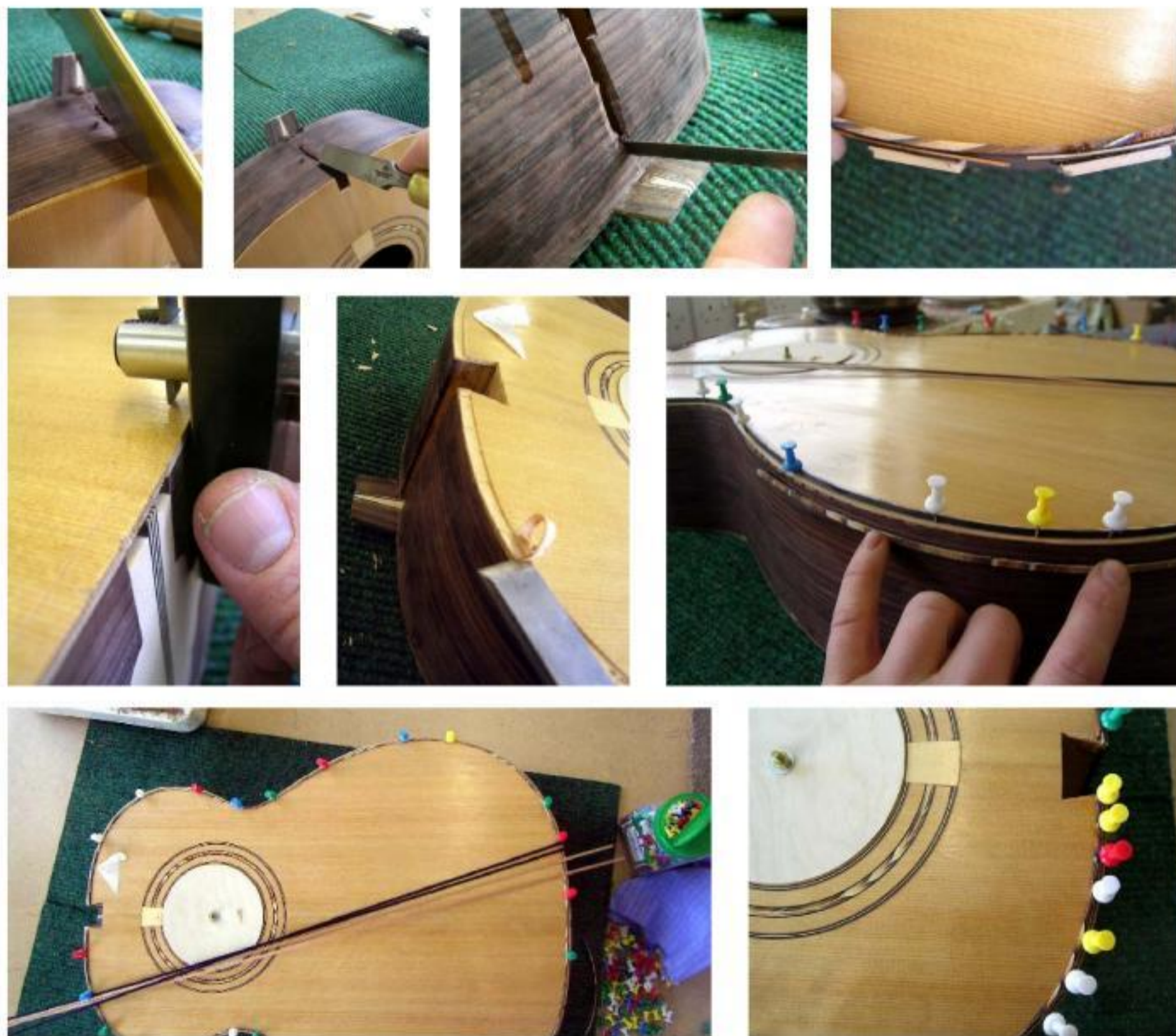

Mar 5th: For re-cutting dovetail I sawed into the space about 5mm away on either side from centre line and gradually made an opening. After this just chiseled making sure to chisel away from myself onto rug on bench. Broke a junior hacksaw blade in two here and this helped in just cutting the excess of the rosewood down to the the heel cap. After this I used the chisel (5/8 inch) to take the rosewood back to the dovetail mortice edges and cleaned up the glue at base of mortice. Mar 6th: Front purfling and binding same way as classical last year although with the rope I had to use the bending iron to bring it into the same shape as the guitar curve. This was not too difficult although it was important to be careful as the tiny pieces making up the rope design were splitting apart quite easily and all that was holding them in place was the backing veneer. When I had the two ropes shaped I pinned them in place on the guitar to test them for fit and to mark where to cut off excess. Then glued both ropes onto body with hot animal glue and held in place with map pins.

## Binding front



Mar 7th: repaired tear-out at edge of soundboard by scraping thinner and sanding all back. Will need a sand back to wood at end as think there are areas that still have the animal glue coat which appear darker from the side. Started purfling. Mar 8th: Most of

soundboard binding channel cut and chiseled today. Hard work! Bit more tomorrow and bend binding maybe to shape. Mar 9th: Finished binding ledge and roughly bent maple bindings to outline and taped in place. Tried to chisel out a little extra material about a half a mm just at the waist both sides where the rope has split, in the hope that when tying bindings on with string it will force the binding to pull in the rope purfling a little to correct the split. Bit more refining shape on monday. Mar 12th: Rebent the bindings today a bit more to get the shape and then taped them in place on the guitar to tackle the mitre join at the end block where the binding runs on to the centre strip down the graft. This was tricky (see next page for working sketches of this) but found that was best to just take a little off with the chisel then compare and keep



doing this till I had one fitting, then follow through with the other side. When had these fitting tied on both bindings with the string to test for fit. Could see a few areas where I needed to do more filing to the binding ledge on the guitar so marked an X on the ribs at these points with a white pencil



to take note of them. Filed these areas of the ledge down with a flat needle file (to avoid the purfling) and then went right round perimeter once more to make sure had got rid of any bumps. Mistake made here was accidentally filed away a part of lovely mitred centre strip of end graft! Hopefully can fix this by scraping end graft down 1mm or so. Once this was done tried a second dry run with the string and was happy now to go ahead with using the hot animal glue to glue them in place. Hot glue was applied in about 4 to 5 inch sections then the binding was held on by hand and excess glue wiped off before taping tightly in place with masking tape (tape all

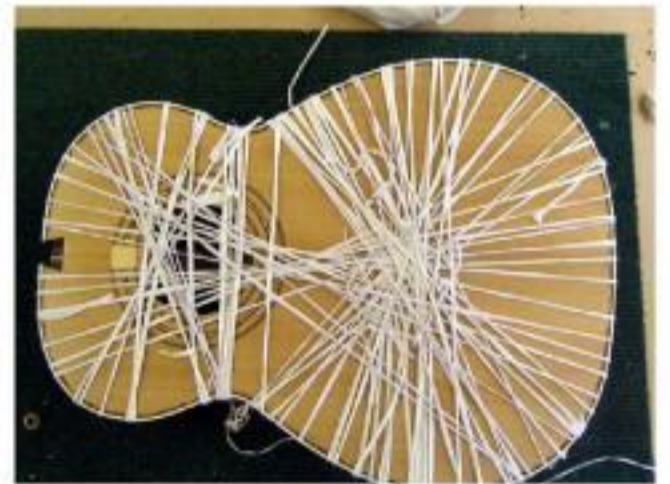

laid out before hand). This process repeated right round guitar edge and then finally I moved onto tying the binding in place with string until I could see no gaps between it and the purfling. Tomorrow heat gun gap areas and re-tie with string to close gaps.

# Purfling ideas sketches

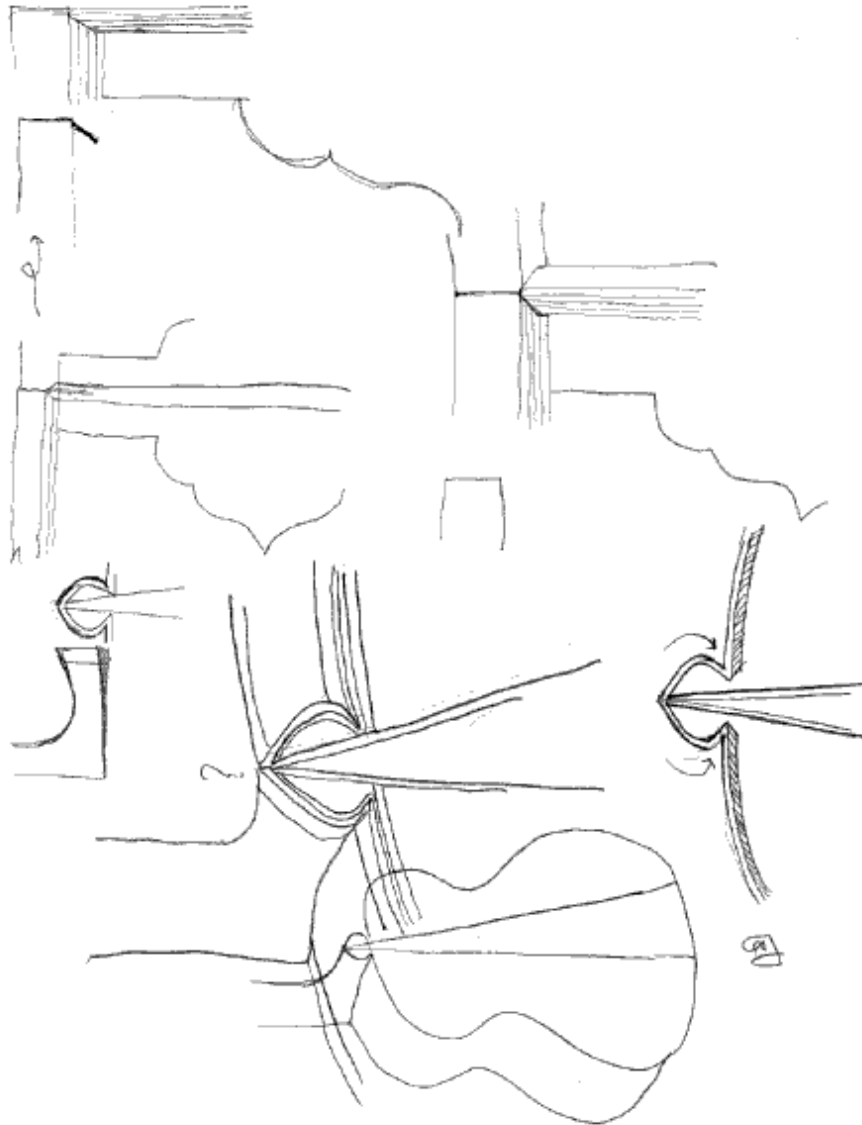
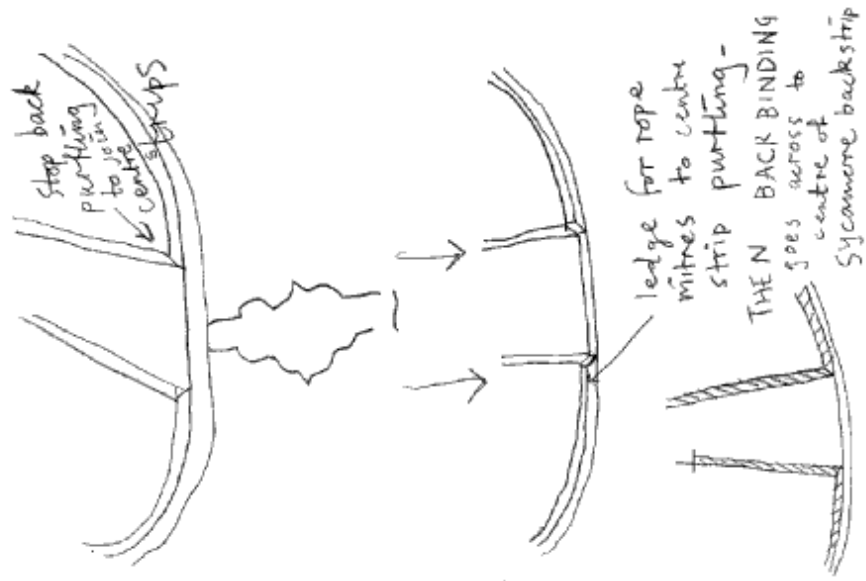

*Using heat gun then re-tying bindings to close gaps*

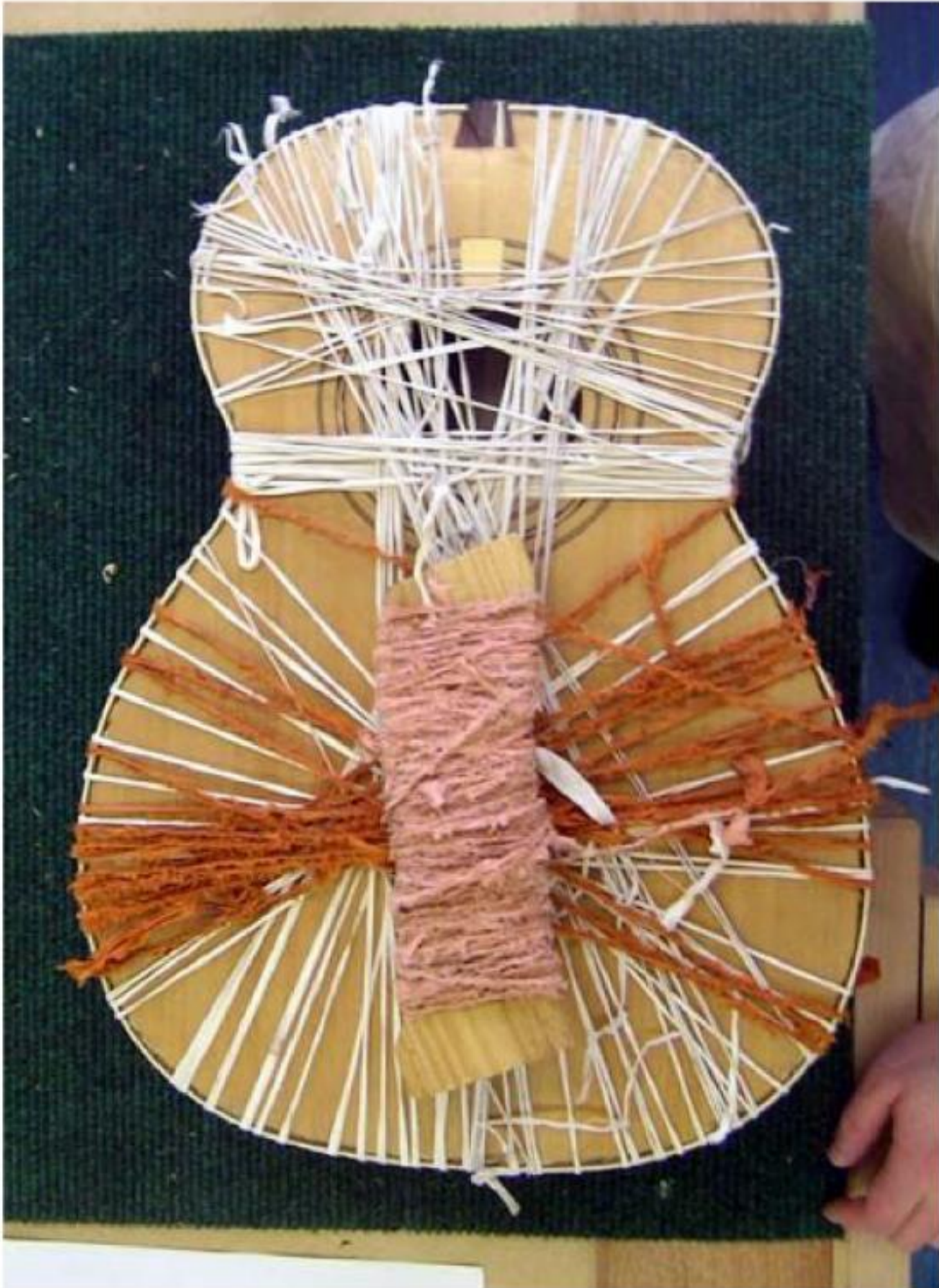

## Back purfling and deciding not to use dremel



Mar 13th: Tried out purfling router attachment for dremel on a scrap piece of timber but wasn't that fussed with the results compared to doing the same job with the cutter and chisel so

abandoned the idea and just going to do it the old fashioned way. Mar 14th: Chiseled and filed flat remainder of purfling ledge and began to set up hob with hot animal glue then remembered needed to bend purfling so put on bending iron - when began to bend rope purfling realised that I had to think about where the rope design ended at both ends of the guitar. Decided it was best if it would end at both ends on one of the plainer sections of the rope so had to hammer the pins in and do a dry run to figure this one out. Put off hob deciding to sort all this out first and do the

gluing tomorrow. Got the design not bad - bit of bending of rope on bending iron and odd repairs to it as it split a bit here

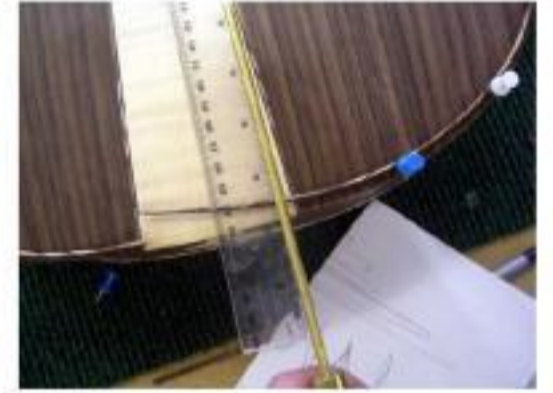

and there. Decided to just butt rope against centre strip rope at both ends as quite a thin line so don't see a need for mitring. Pinned it in place and cut ends leaving 5mm or so extra at end block end which will cut to fit at end of gluing process tomorrow. Mar 15th: Today went in and heated up animal glue and glued on rope to ledge. It went well and for the ends of the rope at the end block end I used a chisel over a piece of thin ply and cut back a mm at a time until the rope fitted in place butting up to the centre strip ropes. Surprisingly the glue had dried

within about 3 hours so was able to take out pins and start planing down the rope which has turned out nice. This was followed by scraper to give nice flat surface on back for using purfling cutter for the bindings. Bindings same as top except for heel cap (see page 99 for this).



*Front and Back*





## Back binding



## Fitting neck to guitar body



Mar 22nd: Today chalked dovetail mortice on guitar body and then fitted the neck tenon to the guitar to begin testing where I needed to adjust the tenon. Material only to be taken off the tenon and not the mortice on the guitar, to make things a bit less difficult. Used sanding sticks initially but realise a lot more material had to be removed so started using chisel and then went on to clamping neck in vice after realising had to be careful how much material to remove. Later used the flat file to remove a bit less material. 3 types of checking of alignment - side to side with straight edge, forwards and backwards with neck angle stick, skew in neck checked by looking down length of guitar body. Using neck angle stick the height at the 14th fret position should be the same height as at the saddle position (before tenon seated down fully in mortice I checked this with a ruler - see photos on left). Got neck fitting not too bad but tomorrow may have to put a veneer in to fill the gap a little. Diagram on right explains use of neck angle stick.

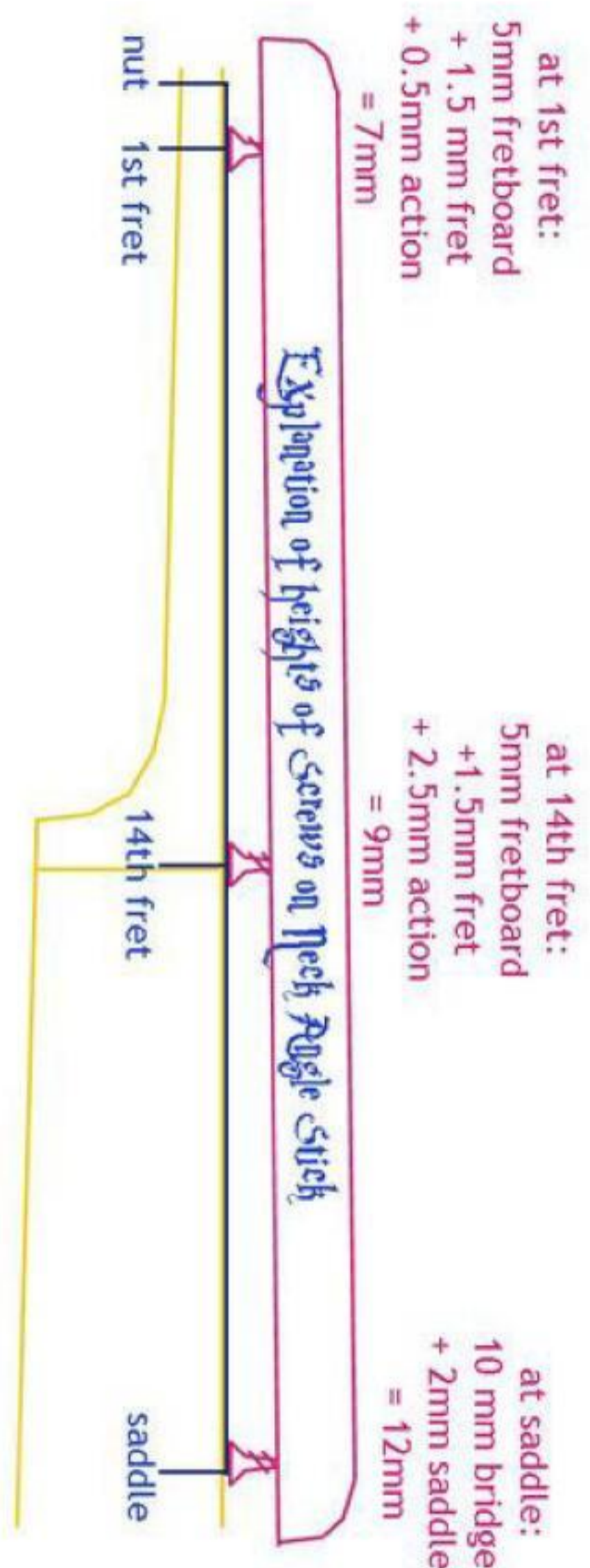

## More fitting neck

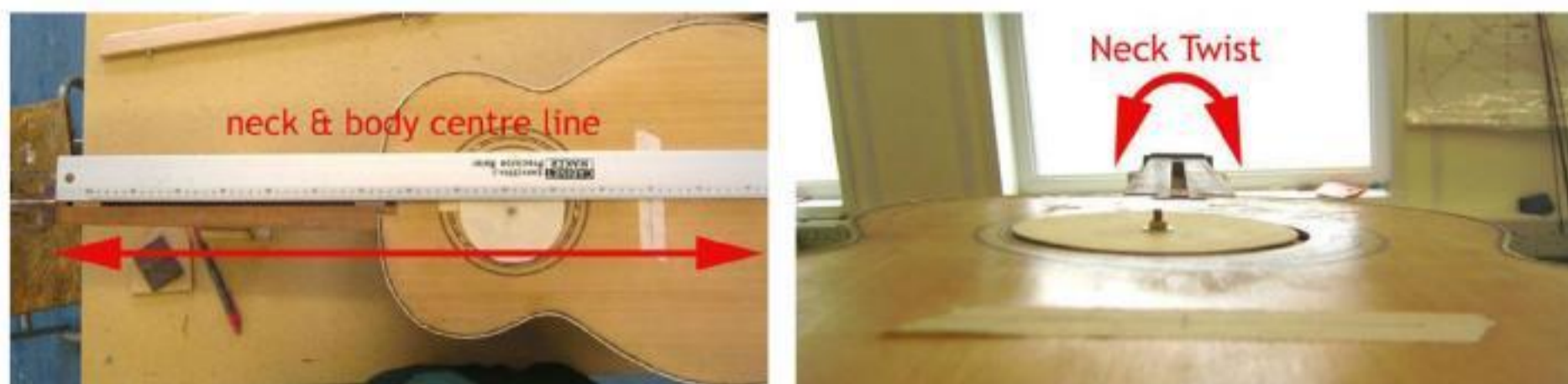

Mar 23rd: Spent from about 9am to 1pm trying to get the neck fitting. As I sanded off more material I had to make a veneer of mahogany for one side of the dovetail which I thinned to maybe 0.3mm using the cabinet scraper. This made the dovetail tight again and was able to do more work on fitting it once more. Had to keep checking neck angle (see previous page) and also guitar centre line (below) and finally also for neck twist (checking looking down from end of guitar towards headstock). Felt I got the neck closer to fitting but there were still lots of gaps I could see and knew of from using the 0.05mm feeler gauge.

Mar 26th: Spent half day further fitting dovetail but found it a bit difficult as whenever I thought I had worked out where to remove a bit of material, when I put it back on the guitar it seemed to be developing gaps elsewhere! Dovetail thinned more so had to put in 2 veneers - one at 0.6mm and one about 0.3mm. At one point swapped position of veneers and found this much better. Bill pointed out that maybe the area of the ribs under where the 'cheeks' of the dovetail on the neck meet may not be flat so checking this I scraped away this area till definitely flat. Decided at this point to animal glue a mahogany veneer to heel cap end of neck to fill the gap between it and the heel cap adjoining back. At end of day cleaned off all chalk from inside dovetail block with a damp cloth. This made the timber swell a bit so fitted the joint together in the hope that the neck would somehow fit great the next day!



## *Even more fitting neck then gluing*

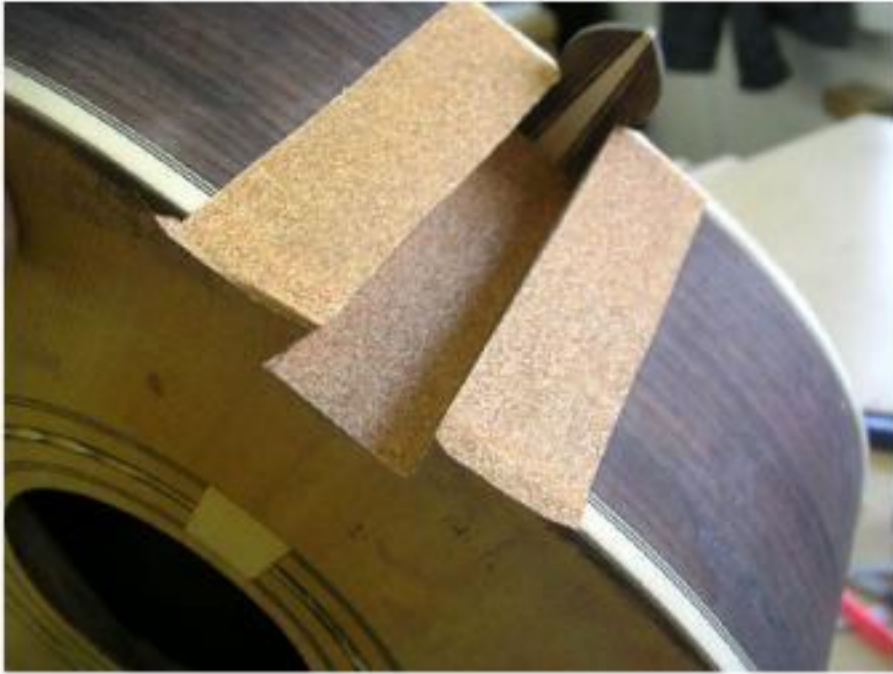

Mar 27th: Today started back to work on it and found myself working a bit more carefully although again I seemed to be making it worse at some points - couldn't seem to quite get 'cheeks' of dovetail meeting the ribs no matter how well I marked which areas were to be sanded down slightly. In the end I thought up this idea of doublesiding some 100 grit sandpaper onto the actual area of the body that the neck was to be glued onto and also at the bottom of the dovetail slot (but not the sides). This worked a little though threw the neck slightly to the side as I found out when checking with the straight edge. To compensate for this I put on one piece of the sandpaper on only one side of the neck and sanded this side to bring the neck down on that side and to bring the neck back towards the centre. The back angle also was out a little so again I tried to compensate for this by focusing the rubbing of the neck at the front area to bring the neck forward a little. In the end I think this technique helped me get the exact shape for the neck to fit the rib surface which I had found so difficult up to the point of using the sandpaper technique. Would use this again. After this the veneers were a bit more like 2 o.6mm veneers but it all seemed to fit nice so I scraped back the soundboard side a little to clean it up and then made sure neck was sitting right down into joint so that the clamping caul (covered in glue resistant plastic) would clamp both body and neck completely flush. Glued up finally and cleaned up with some hot water then set about getting fingerboard prepared.



# Heel cap sketches

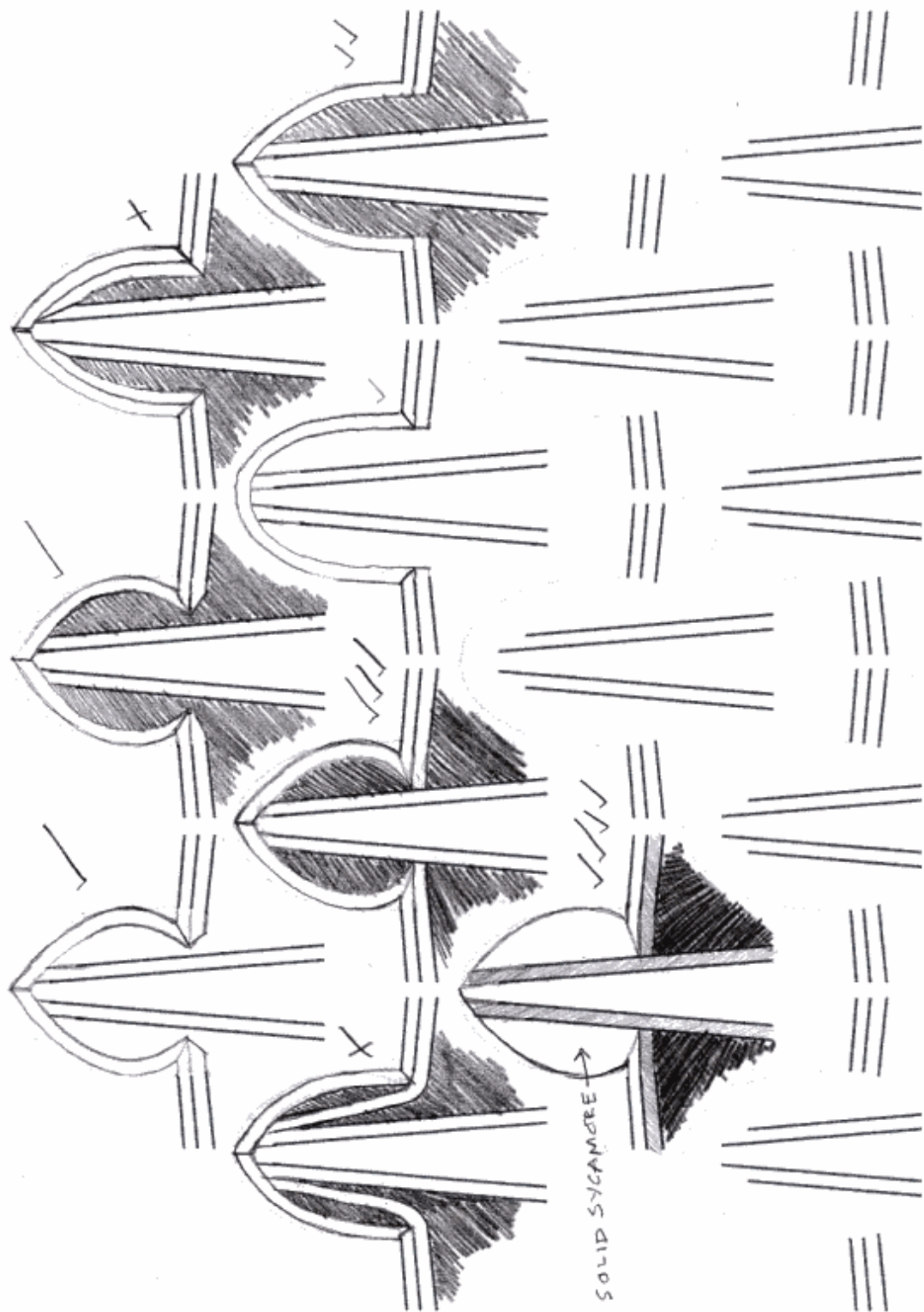

## Binding the heel cap

Mar 28th: Bent the light Maple binding over the bending iron using the brass strap to stop break out of the wood. Initially steamed the binding across the iron with a damp cloth covering it and then bent it round the less sharp curve first then the sharp curve immediately afterwards to keep the momentum of the wood moving. Cracked a couple of the bends but managed to get 2 good curves - the purfling BWBW at the bottom of the binding came a little loose but pressing this down on top of the iron seemed to fix it. Cut away a channel on heel of guitar using the purfling cutter again refining with chisel and flat file. Cut out the 2 sections of binding for



the heel cap and found it difficult to work out where the centre join would be at the tip. Tried animal glue to secure the corners but this did not seem to be strong enough without leaving perhaps overnight so resorted to supergluing mitred corners of bindings in place hoping to stretch round rest to tip to make a nice join. This worked and when I thought I had a perfect mitre I just decided to use the superglue to glue two pieces in place as it seemed to be quite firm in gluing the corner mitres. Job then got a bit fingers and thumbs (finger stuck to guitar at one point!) and before I knew it, it was glued in place. After the event realised I must have cut deeper



down than the binding itself as the BWBW on one side wasn't aligning with the body binding - also there were big areas where the superglue had soaked into gaps and darkened the wood a lot (thought maybe could touch these up later with paint). The join at the tip also went quite badly wrong and there was a gap looking like a black line at the top. Also the way I had put the binding on it was sticking out over the heel so to make the binding flush to the heel I had to carve away a lot of the two binding halves at an angle while trying to retain the top band of white. In the end wasn't really satisfied but thought perhaps should just leave it and put it down to experience!

## Re-doing heel binding



Mar 29th: To disguise the bad join in the tip of the heel cap I tried to put in a small piece of white veneer with the plan that I could then run a couple of black paint lines across the top to make the purfling appear continuous. Did this then sanded back and kept trying to get the binding to look nice to



the eye. Worked away but somewhere along the way thinned one edge too much that it was thinner than the body binding and after this just went about chiselling off the heel cap binding very carefully and re-doing it. This time decided to make the heel cap smaller and make the ledge so that it definitely would accommodate the full width of the binding. Made it symmetrical and checked this using a mirror which is a good way to check if something is symmetrical or not. Took about 30 mins to get it back to a nice stage for re-doing and then set about re-bending another binding on the hot bending iron.

This worked fine, 2 out of 4 bends were suitable and this time I tried to have less of a curve than the first cap bindings so it was easier in a sense because of this. Once had mitres establish I then cut the tip joins a bit longer than needed and as before superglued the mitred corners in place. I then gradually worked my way to a good tip join by filing a little off at a time until it was looking like it would join well.

I then cut a V notch from a small piece of hardwood as a caul and put on some doublesided to stop it gluing to the heel cap. I then set up a sash clamp over the back from end block to heel cap (making sure to put a caul over the end graft to protect it) and then set about gluing up the cap binding. Decided to use titebond for the remainder of the cap binding as felt part of the problem with the superglue was it set too quick and there was no movement left in the joint for me to clamp it any more tightly. This time I used the titebond and the V caul to



bring the 2 sides of the tip together as I applied pressure on the clamp. This worked very well (hopefully). Glue squeezed out very well and binding seemed to be sitting nicely far enough into the mahogany of the heel. Dropped two spots of superglue onto the mitres as a final touch to makes sure they hold.



*Close up of heel cap binding being glued*

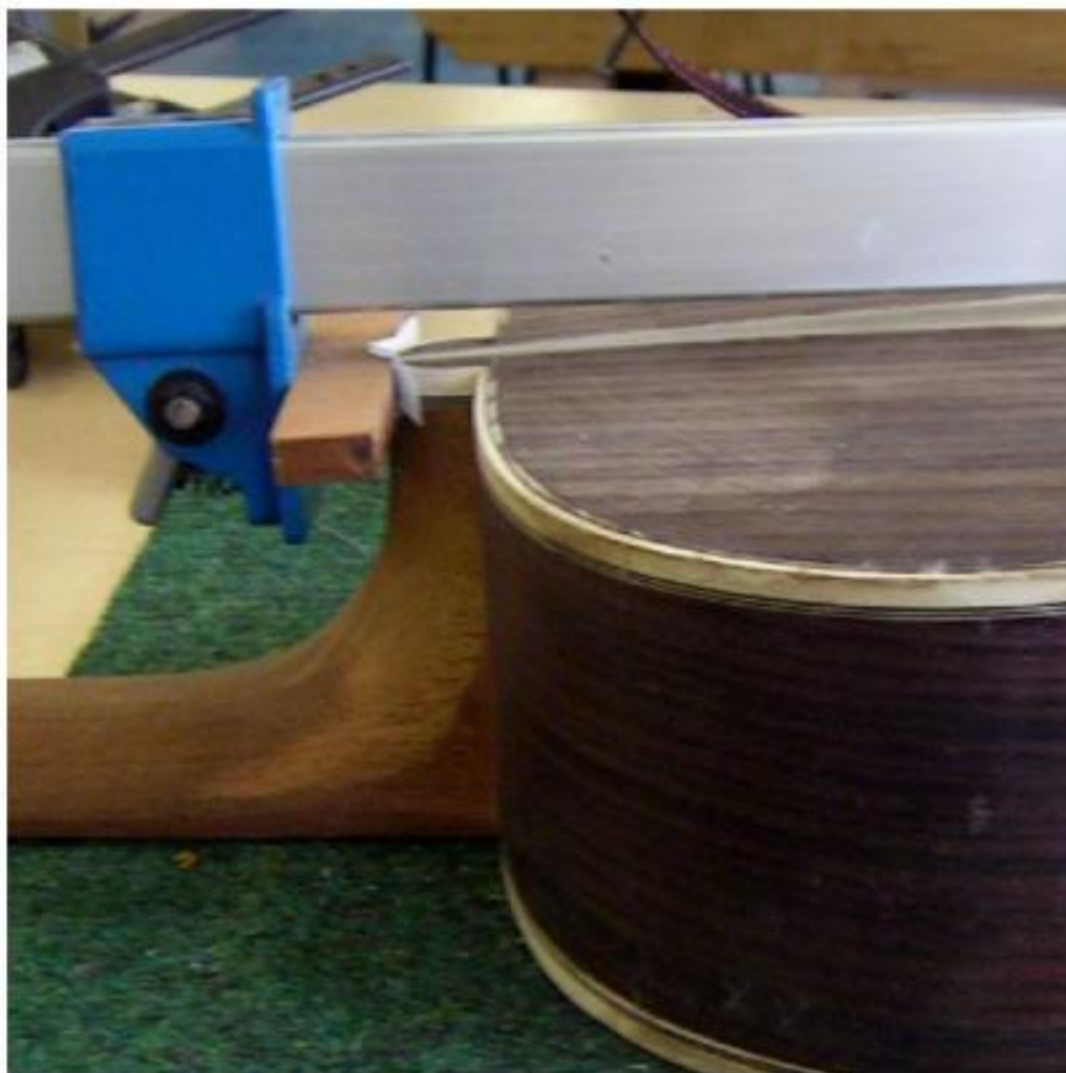



*Sketches for fingerboard end design*



**12th fret ideas**

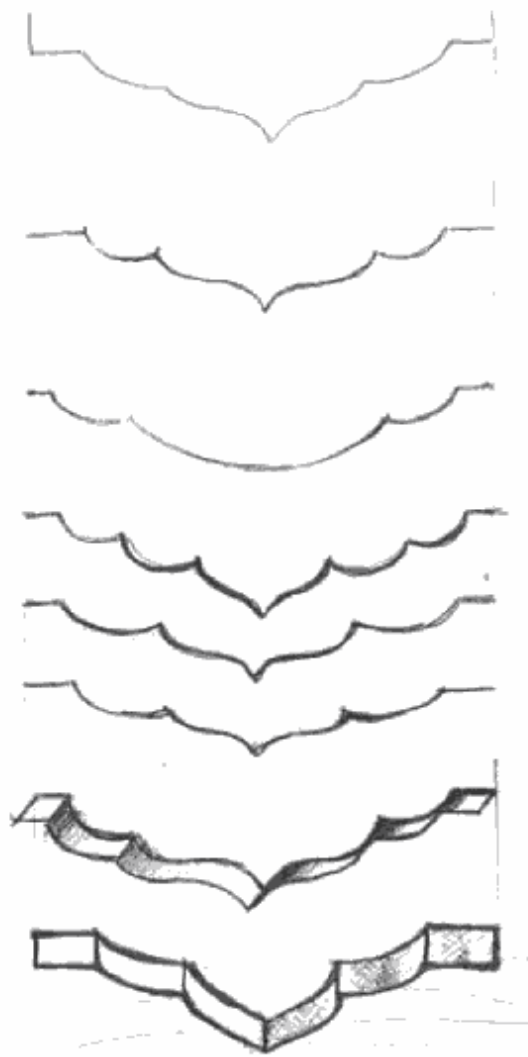

**fingerboard end ideas**

## Fingerboard preparation

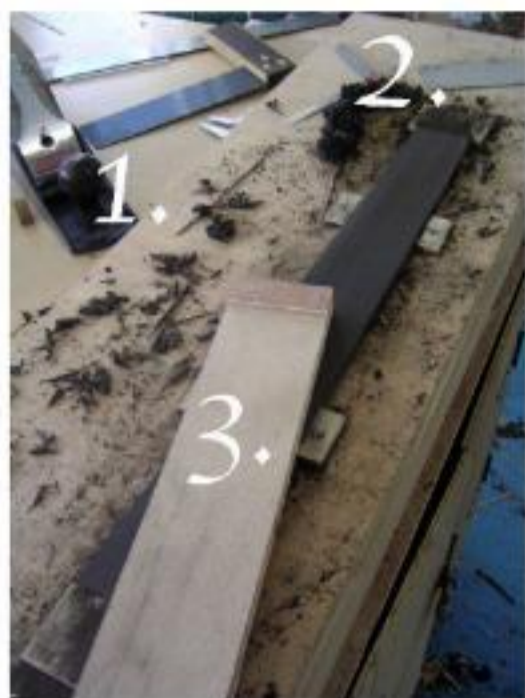

Mar 20th & 27th: On the fingerboard I had one area that was hard to plane and trying to plane from the other direction didn't seem to work either. So after asking a bit of advice I used a sharpened hard cabinet scraper and ran it along from one to the other and this seemed to work better and began to take out some of the mad bumps across the width of it. I followed this with an mdf sanding block which I had checked for flatness with a straight edge beforehand. This further flattened the fingerboard and this will be the surface to be glued face down onto the neck. The top surface for playing on will be sorted once glued on the guitar. When planing the side edges of fingerboard there was again lots of tearing out so had to use a sanding block once more in place of the number 7 plane and shoot the edges along the shooting board sanding instead.



Apr 17th: With fretboard now cut to the correct width I had to next plane the nut end flat. Discovered planing was no good again as wood was too brittle and cross grained so tried filing the nut edge with the fingerboard propped up on a board just enough to allow the full fingerboard edge to be filed evenly. Kept checking with a straight edge - This took quite some time. Kept filing the bit I thought would correct the situation then some other part would have changed. Gradually I got there in the end so next had to begin the marking on of the fret positions along the centre line using a straight edge and a scalpel for marking. The eyeglass really helped this process - felt was able to be accurate maybe within thirds of millimetres anyway. Marked these on with a small scalpel cut on centre line to begin with and then when all fret positions were marked I used the sliding bevel to mark on each fret with a full scalpel line. Had to make sure that the sliding bevel was set according to the fingerboard taper and matched up using both edges. Once this was done I had planned to do a design on the end so I didn't scalpel in the 20th fret as wasn't sure whether the 20th fret would fit in with the design. I drew on the design for the end in pencil, mirroring both halves to make sure it was all symmetrical. After this just approached cutting the design out the same way as with the headstock and the end graft (and later the bridge), using a chisel and having the piece clamped in the bench vice against a board to stop the grain splitting. Because was ebony, I needed to use quite a bit of force to cut the design into the wood.

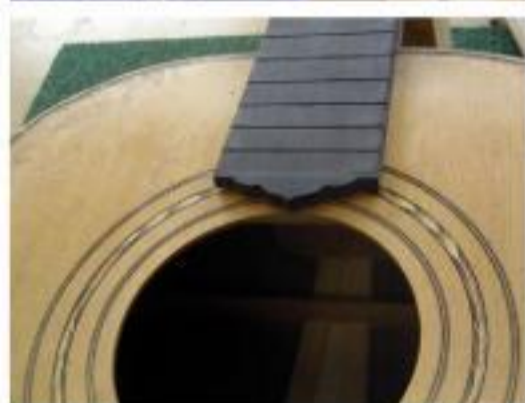

Few chips flew off here and there and glued them in place with superglue. Hard to locate the chips that flew off onto a floor full of similar looking pieces! So now this was all done set about doing the fret slots. Thought maybe I should have checked the fret markings again but decided I had done it as well as I could so just got right down to cutting the 19 slots. This was hard work but got there in about 1 to 2 hours this time compared to maybe 8 hours or more last year.

## *Fitting truss rod in recess on guitar neck*



Apr 18th: Before gluing on the fingerboard I had to go about fitting the truss rod in the guitar so firstly I had to rout away the area where the truss rod enters from the neck into the inside of the guitar body where it will be adjustable with an Allen hex key via the soundhole. Made sure to clamp guitar down to bench gently yet firm to stop the dremel router base shifting around. This worked great and was quicker than chiselling. After this had to saw bit off truss rod and aluminium box covering rod for them to fit into the channel on the neck in such a way that the hex nut sits flush with the surface of dovetail block on the inside of the guitar. Tight access here with a hex key means will have to get an allen key and cut it down so it only has 20mm at point of entry so as to avoid the tranverse bar above soundhole. Had to retap the thread on the rod here and take it down further than the size of the truss box itself to allow the hex nut to tighten against the box and apply tension to it in order to make it bend the neck backwards. Made a mistake here by filing flat the other end of the truss rod at the square bolt end - when I filed it flat the rod started screwing out of that end when turning the other end so Bill suggested hammering the end as though a rivet. Before I did this I then had to retap another 5 mm onto the thread at that end too. This left a few mm excess which Bill helped me to hammer down a bit in order to stop the bolt from loosening.

## Gluing truss rod and cover in place



To get the rod to fit had to use sandpaper on a block in the slot on neck but also I tried to slim the aluminium box for the rod a bit as felt it was a bit lumpy here and there. The combination of both methods gradually seemed to make the truss fit better until it was fitting tight but without trying to force it into the channel (forcing it in might split the neck lengthwise). Next had to make a mahogany truss rod cover. Used a piece from the old telescope tripod legs which was nice mahogany. When this was done I put it in place on top of truss rod in the slot and then fine planed it down flush with the block plane till the truss rod cover surface blended with the neck surface. This was partly a mistake - The truss rod cover I should have left standing proud of the neck a few mm and then once glued I could have planed back much more flush. Next set up some big G clamps - 5 in total and a phone directory. Made a small caul thinner than the mahogany truss rod cover in order to make sure that when I glue all the pieces in place they stay that way. Firstly put the truss rod's open side onto a strip of masking tape and scalped away edges - this is to seal the box to prevent the araldite epoxy glue penetrating the truss rod mechanism. Checked truss rod for rattle then applied 2 part araldite epoxy (blue) to the inside of the truss rod slot but not the bottom face of the slot, only the sides. Was a bit messy at this stage but kept it going fast as wasn't sure if had fast or slow drying epoxy! Put truss rod and box in together masking taped side of box down the way, then more epoxy on inside face of mahogany truss rod cover and put that down onto truss slot. Then used the caul and clamps to get the whole thing firmly clamped. Cleaned off excess glue as got clamps on. Next will be fitting the fingerboard and fretting which I wrote about last year in the classical logbook. Apr 19th: Checked on edge fit of fingerboard and it seemed good then drilled in 2 guide pins (1.5mm drill bits). Further checked once more for fit and seemed good - Rab reminded me about Bill's talk the day before about scooping both gluing surfaces slightly down the length with the cabinet scraper to compensate for the 2 surfaces possibly curving away from each other when wet with glue. I had a look at the fingerboard gluing surface to see what it was like and it looked flat

more than scooped but ended up going ahead and not doing the scooping. Soon realised once was gluing up that although beforehand it was a fine fit, when wet with glue some of the edges had indeed risen by a fraction of a mm! Tried my best to just add more clamps to pull down these areas more and ended up with 13 clamps on it! Will definitely do as Bill and Rab suggested next time! Other mistake here was that forgot to remove a wee bit of glue from fingerboard where the truss rod was exposed before gluing. Didn't think of this till some of the clamps were already on so worried that the glue will have seeped out inside guitar around the rod.

*Fingerboard clamped on*



## Radiusing fingerboard



Mar 23rd: Today just a look to see if the truss rod had got clogged with glue but it seemed fine and tried hex key to make sure. Began process of radiusing the fingerboard putting a slight curve across the fingerboard surface to make playing barre chords slightly easier. Was supposed to be about 1mm taken off at edges and slowly rounded back towards the full height of about 5 to 6mm.

In the end went way too far, and now it has about 2mm at edges going into a curve. Put the neck rest under the 6th fret position of the neck while sanding the camber into the fingerboard to concentrate on that area to be where the string relief is. String relief is a slight dip or bowing in the guitar neck to allow the strings to vibrate free from the frets and can help compensate for later occurrence of slight back bowing of the guitar neck due to wear and tear, atmospheric changes or simply the nature of the timber.

Any forward bowing can then be compensated for by using the truss rod which will pull it back the way. Kept checking my fingerboard was



flat along the length until was a bit happier with the camber. When I felt I was getting there with it I then start focusing on the 6th fret area with a smaller sanding block and tried to sand away a slight dipping as mentioned above. In the end think that the camber is too much and feel I would like to correct this a bit by slightly flattening the central area. Also noticed today that my sanding has not been completely flat along the length as there is a slight skew to the way I have sanded (on picture on the right the right edge is higher than the left. Have still to tidy the neck up to final profile and thickness so going to leave fingerboard till that is done and then tackle fixing it in the way I have mentioned above.

Apr 26th: Today done what I asked Bill and Paul about regarding the fingerboard string relief. With the board reading as flat with the straight edge, I tightened the truss rod maybe a quarter of a turn and then checked the neck again. It now had a back bow appearing as a lump in the 6th or 7th fret area. I now sanded the fingerboard in this tightened state until it appeared flat with the straight edge. When this was done I loosened off the truss rod and when I checked with a straight edge I now had some string relief in the 5th / 6th / 7th fret area! Next onto inlay.

# Fingerboard sketch ideas

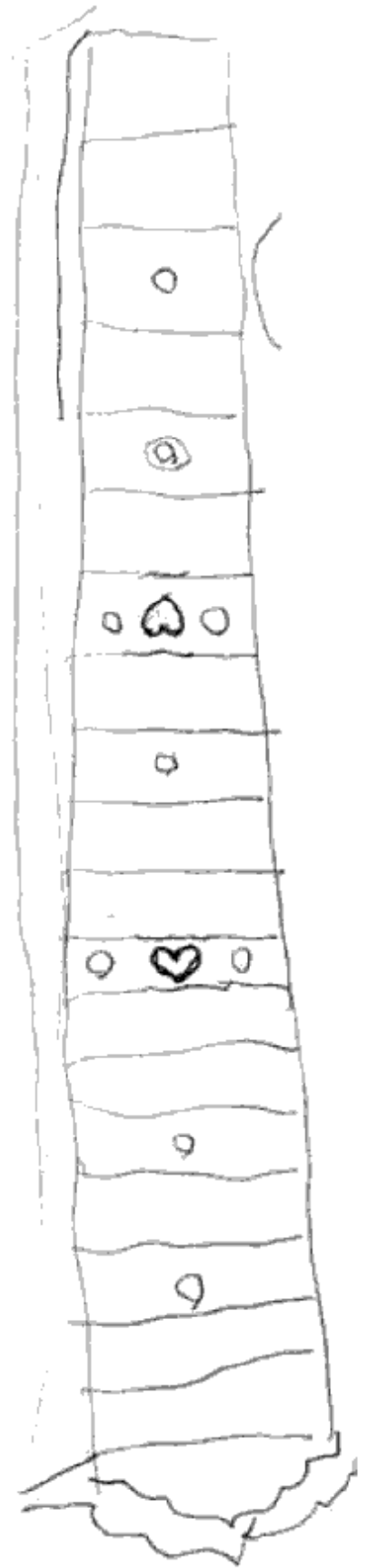
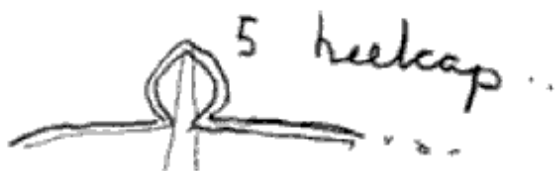
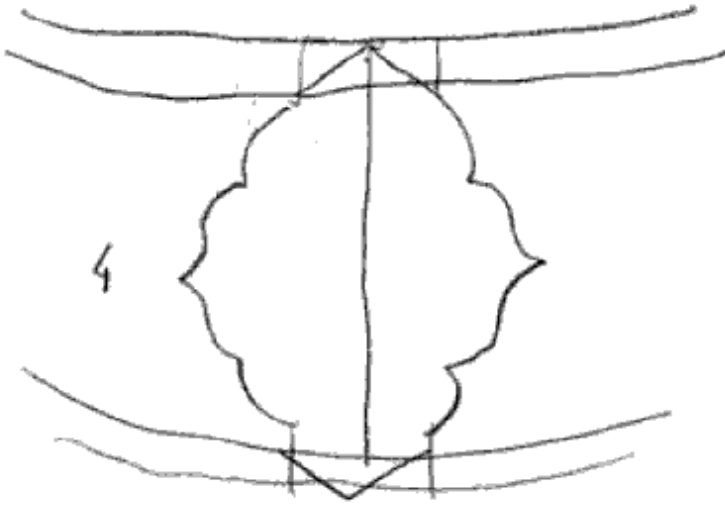
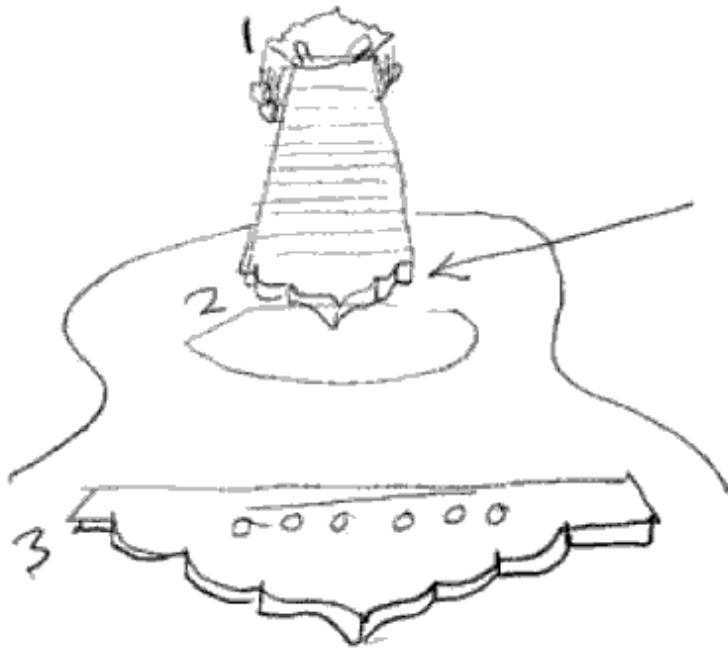

## Inlay work on fingerboard

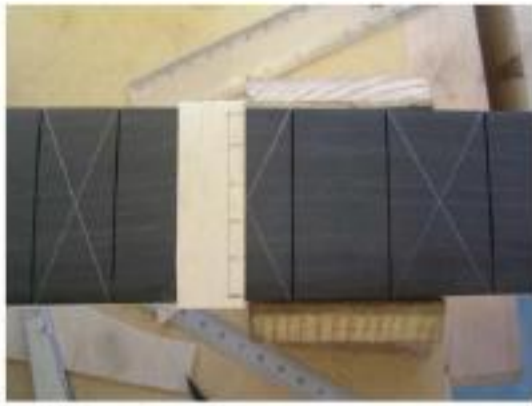

Apr 27th: Today after had sorted out the string relief on the fingerboard I was then able to set about inlaying the nine 6mm New Zealand abalone dots and the two 8mm mother of pearl dots. Chose the layout from looking at other other guitars I have seen but also trying for something unique. The layout i chose is the same as sketch on previous page except I chose mother of pearl dots instead of the 2 heart shapes, just to save time mostly. Initially for the centre dots I drew an X corner to corner across all frets where there was to be a dot {3rd, 5th, 7th, 9th, 12th, 15th, & 17th}. For the 2 frets where there was to be 2 additional dots either side of the central one I made up a little template showing the six string positions to try to make

sure that these dots would be positioned exactly between the 2 outermost strings on either side. Measured 4 to 5mm in from the edge on both sides then divided the remainder of the width by FIVE and then used this template as a guide to mark on the dot positions. Before drilling I centre-punched each dot position on the fingerboard and then once this was done I used a 'BRAD POINT' drill fitted in a hand drill and carefully drilled down a little at a time to see if the dot would fit just slightly proud of the surface. This mostly worked fine - one dot went a little far down and the 8mm dots were slightly wobbly as the 8mm brad point left a bit of a hump inside the drill hole just due to the shape of the bottom of the drill bit itself. Maybe a forstner would have been better for this job as Pete suggested? Once all holes drilled - used fast setting Araldite 2 part epoxy to glue all dots in position. Bit messy and hard to wash off hands but managed fine. Next thought would just do the 2mm NEW Zealand abalone edge dots too so repeated this process this time using a standard 2mm dormer bit to drill the holes, and used a dab of superglue to fix them in place. Had to widen the holes a little with other end of drill rocking it slightly in the hole and when gluing used a flat file to force each dot into place in the holes. Filed back damping the shell dust with a wet cloth as the dust is very hazardous.





## Mistake with fretting

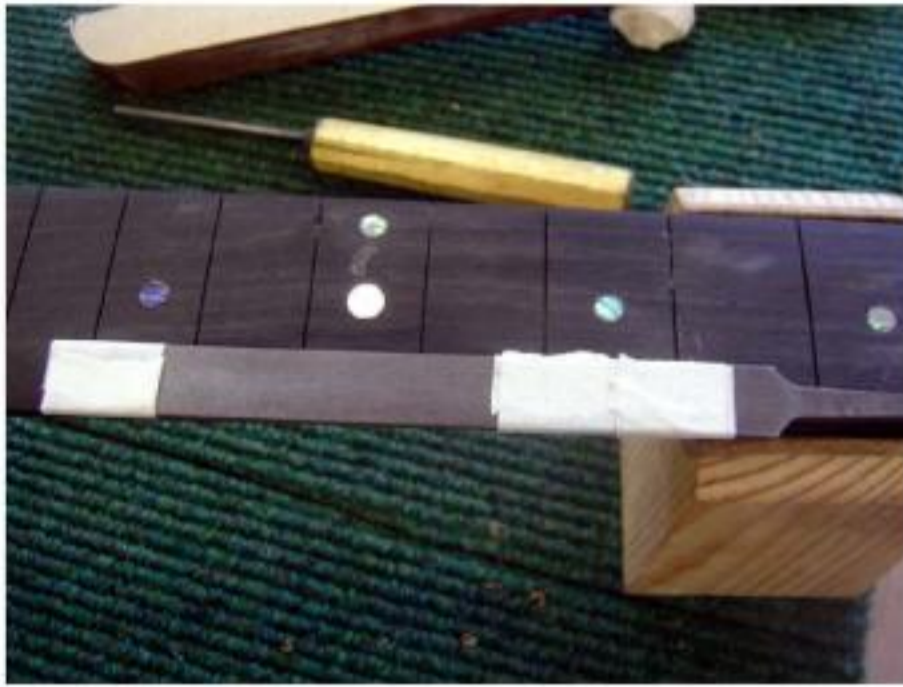

my string relief so then had to attempt to reproduce the effect all over. Started recutting fret slots a bit deeper checking they were at least 2mm deep using the same saw I cut the slots with in first place (the same saw I used last year for classical fret slots). The tang of the fretwire is about 1.5mm high so a 2mm slot should be enough to allow the fret to be seated properly by the hammer blows without the fret hitting the bottom of the slot and bouncing back out. I deepened every every slot using the gent saw but as i got further along towards the soundhole end Bill noticed me hammering

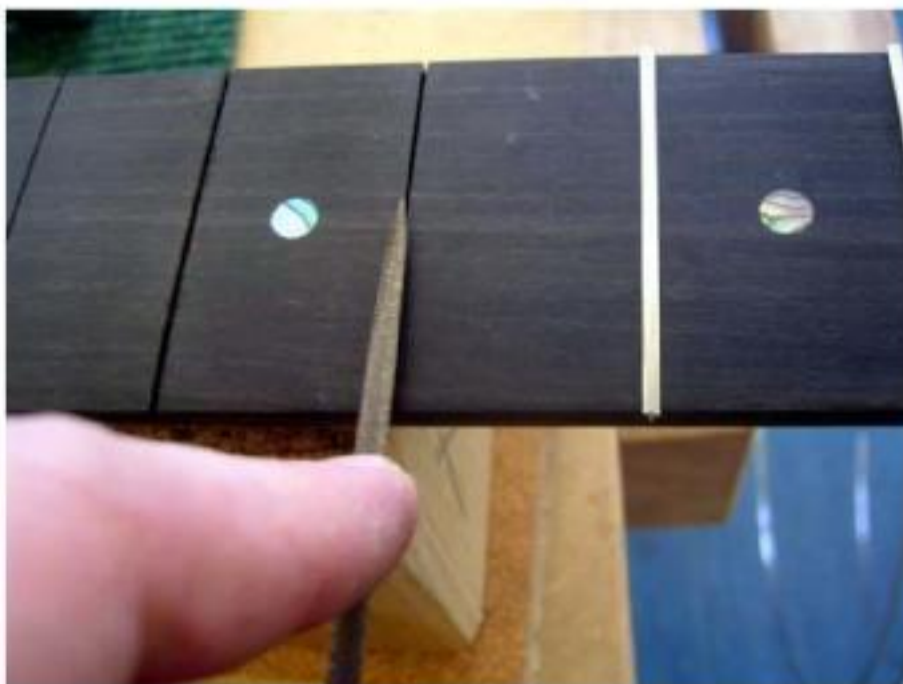

Apr 30th: Put one layer of masking tape round both ends of flat file and used along fingerboard to flatten dots down more - next time some electrical tape might be good for this job. Finally used a sanding block to take the dots down flush with the fingerboard. Started sanding away but forgot should have tightened the truss rod again before starting (as mentioned on [Radiusing Fingerboard page](#)) as totally sanded away



heavier and heavier and said maybe the slots were too narrow causing a gradual back buckling of the fingerboard and in the end the lovely string relief was gone once more! Paul said the tang of the wire should match the size of the cut slot exactly as the triangle burrs on the fretwire is what holds them in place. That way there is a minimum of back buckling. Paul said string tension may correct this and bring it flat again. Will see tomorrow if refretting may be an option?

## Deciding on volute at back of headstock



Apr 30th: Last week had started trying to carve out a nice shape a bit like other 'taj mahal' designs on guitar mostly just to lessen the scarf join line that was quite visible. This goes back to mistake with how close i made the machine head roller holes to the nut. The wee design i made on the back looked quite nice but think because i never planned to do this at the design stage, there were some angles from which it just looked lumpy. Today spotted this and just thought would go for a clean curve and think it looks nicer now though there still some bits need a little more carving (see arrow)! Important to get it looking okay from all angles.

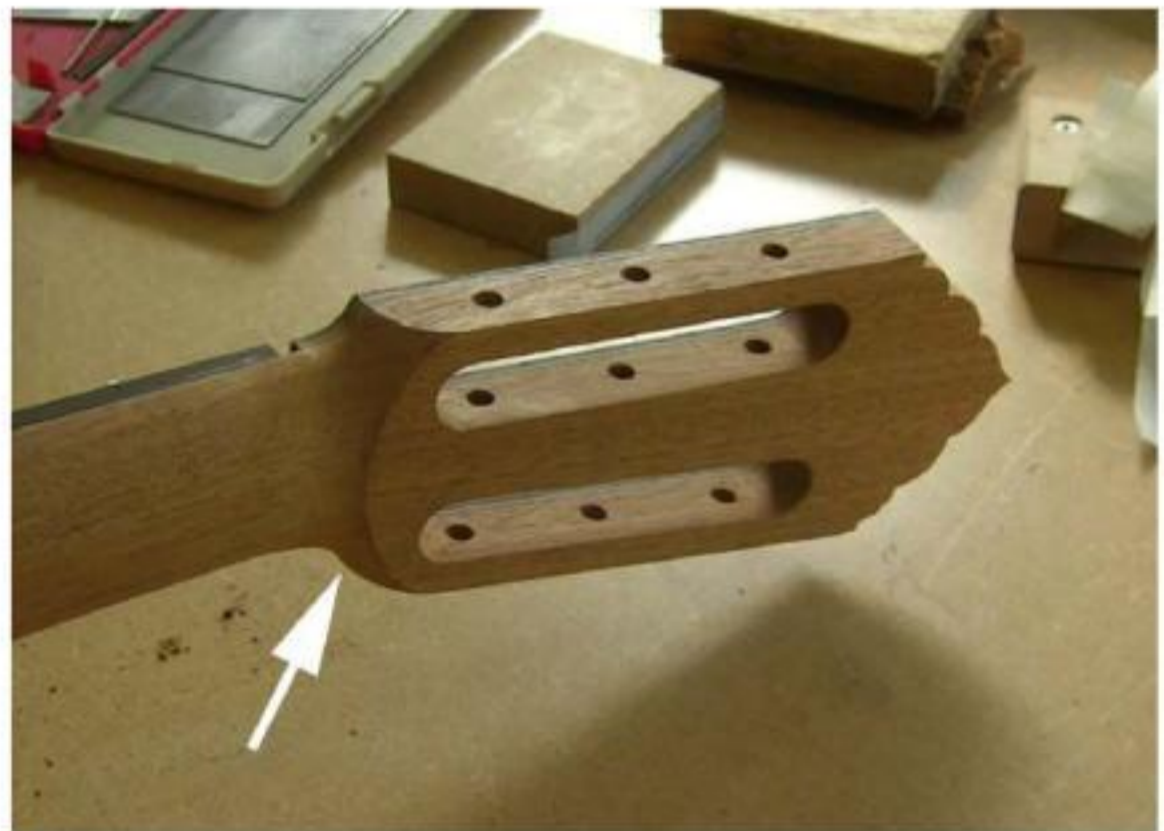

## Preparing for Polishing

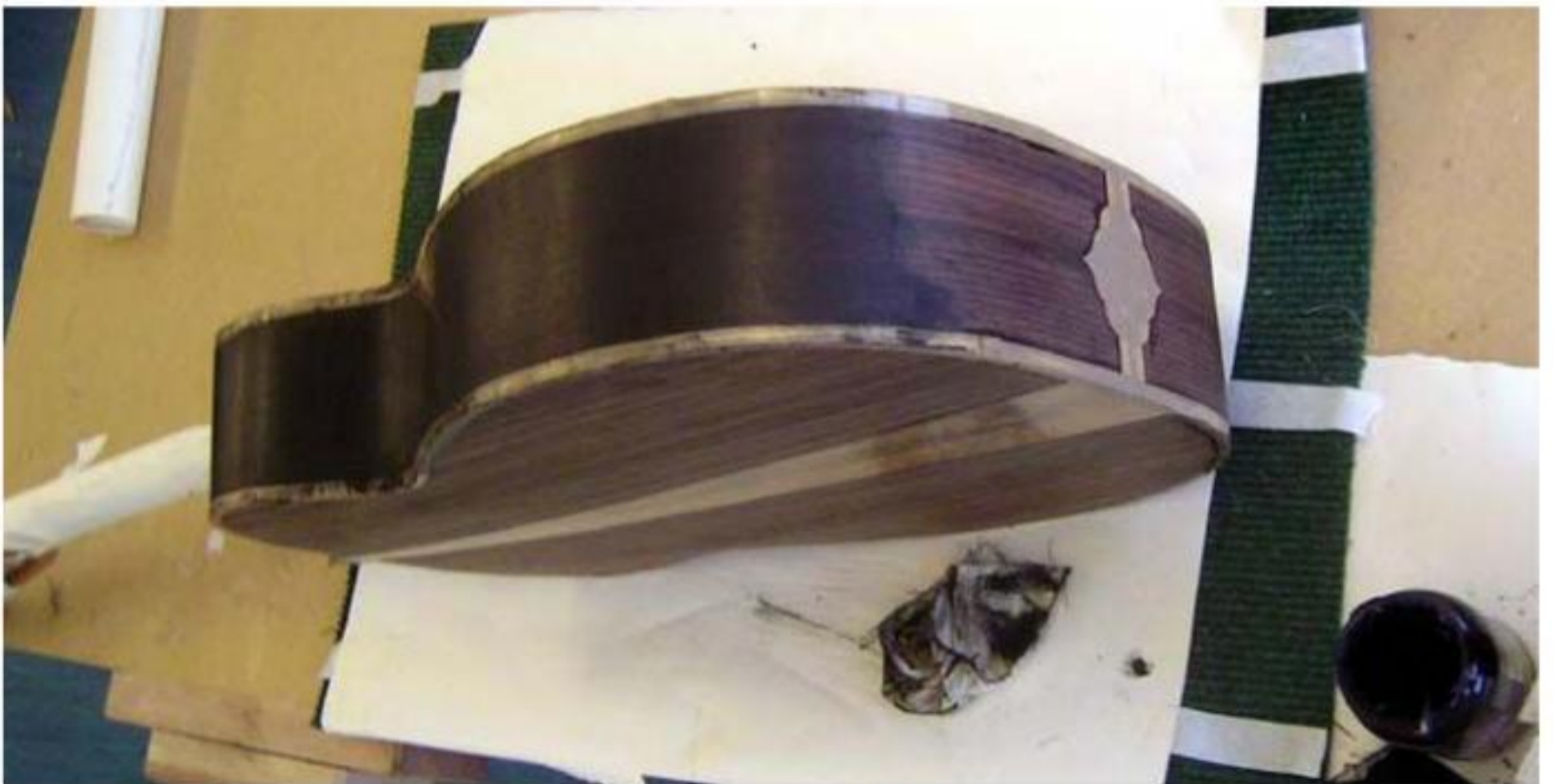

1: sanding burnt area of ribs at waist from bending iron, 2: steaming out a small dent in the binding with the soldering iron and a cloth, 3: sanding back of neck flat, 4: filling gaps with veneer and superglue under fret wire on fingerboard, 5: painting polish onto bindings, 6: parcel tape to mask off light wood before grain filling, 7: Grain filling a rib with a mix of thixotropic grain filler, carbon black and turpentine substitute.

## *Leading up to end of course*

MONDAY	TUESDAY	WEDNESDAY	THURSDAY	FRIDAY
<p>30th April fret guitar</p> <p>white paint on heel binding etc to cover marks</p>	<p>1st May redefine back of headstock</p> <p>cleaning up guitar</p> <p>sand off fingerboard dots</p>	<p>2nd May covering up light wood areas</p> <p>grain filling</p>	<p>3rd May grain filling</p>	<p>4th May grain filling</p> <p>finishing</p>
<p>7th May finishing</p>	<p>8th May finishing</p>	<p>9th May finishing</p> <p>making bridge</p>	<p>10th May finishing</p> <p>making bridge</p>	<p>11th May finishing</p> <p>making bridge</p>
<p>14th May finishing</p> <p>making bridge</p>	<p>15th May finishing</p> <p>making bridge</p>	<p>16th May finishing</p> <p>making bridge</p>	<p>17th May finishing</p> <p>making nut and saddle</p>	<p>18th May finishing</p> <p>making nut and saddle</p>
<p>21st May finishing</p> <p>making ebony scratchplate</p>	<p>22nd May finishing</p> <p>gluing on ebony scratchplate</p>	<p>23rd May gluing on ebony scratchplate</p> <p>stoning and profiling frets</p>	<p>24th May stoning and profiling frets</p>	<p>25th May gluing bridge</p>
<p>28th May gluing bridge</p> <p>drilling bridge pin holes &amp; end pin hole</p>	<p>29th May drilling bridge pin holes &amp; end pin hole</p> <p>fitting machine heads better</p>	<p>30th May fitting machine heads with screws etc</p>	<p>31st May fitting nut and saddle</p> <p>slotting nut</p>	<p>1st June fitting nut and saddle</p> <p>checking intonation &amp; string heights</p>
<p>4th June checking intonation &amp; string heights</p>	<p>5th June playing in a bit</p> <p>checking intonation &amp; string heights</p>	<p>6th June playing in a bit</p> <p>checking intonation &amp; string heights</p>	<p>7th June guitar should be done for concert</p>	<p>8th June what next?</p>

*Some french polishing photos day 1*



*Some french polishing photos at home days 2, 3, & 4*



*More french polishing photos days 5, 6, 7 & 9*



## Last weeks

SUN	MON	TUE	WED	THU	FRI	SAT
20th May	21st May	22nd May	23rd May polishing  making bridge	24th May making bridge - saddle slot  take home:  guitar polish rubbers methis white oil my wet/dry lubrasil 1200 wet/dry	25th May (HOLIDAY) polishing (thinner and thinner coats concentrating on top)  stoning and profiling frets	26th May (HOLIDAY) polishing (thinner and thinner coats concentrating on top)  stoning and profiling frets
27th May (HOLIDAY) polishing (thinner and thinner coats concentrating on top)  stoning and profiling frets	28th May (HOLIDAY) polishing (thinner and thinner coats concentrating on top)  stoning and profiling frets	29th May making bridge - pin holes / carved areas	30th May glue bridge	31st May drill out pin holes on guitar / fit pins  make nut and saddle	1st June make nut and saddle  fit machine heads  take home: guitar	2nd June fitting nut and saddle  checking intonation & string heights
3rd June fitting nut and saddle  checking intonation & string heights  burnishing	4th June fitting nut and saddle  checking intonation & string heights  burnishing	5th June playing in a bit  fitting nut and saddle  checking intonation & string heights  burnishing	6th June playing in a bit  fitting nut and saddle  checking intonation & string heights  burnishing	7th June playing in a bit  burnishing  guitar should be done for concert	8th June fitting nut and saddle  checking intonation & string heights  burnishing  scratchplate?  take home: guitar	9th June fitting nut and saddle  checking intonation & string heights  burnishing  scratchplate?



## *Making steel string bridge*

# Bridge development

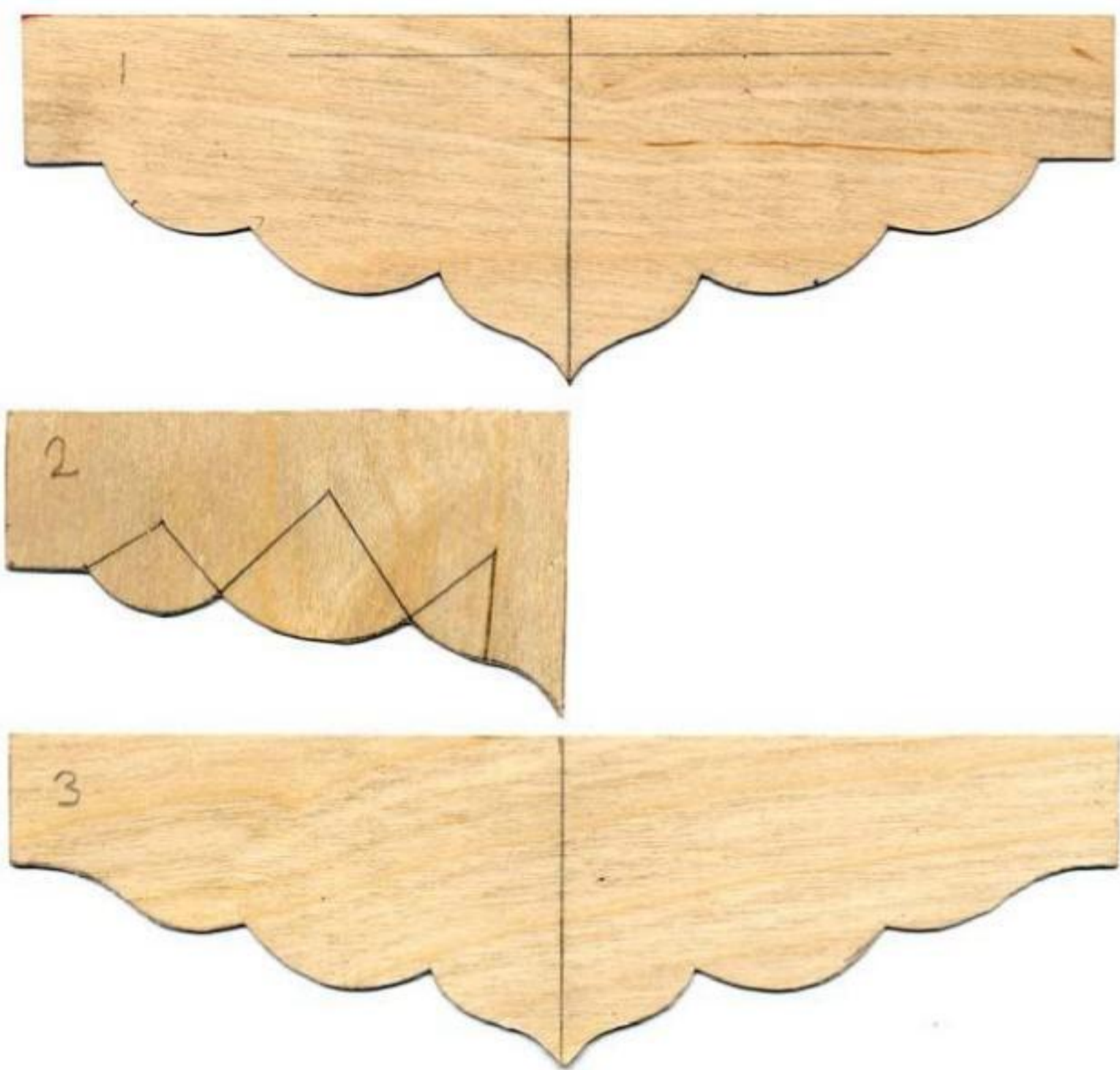

Bridge sketches

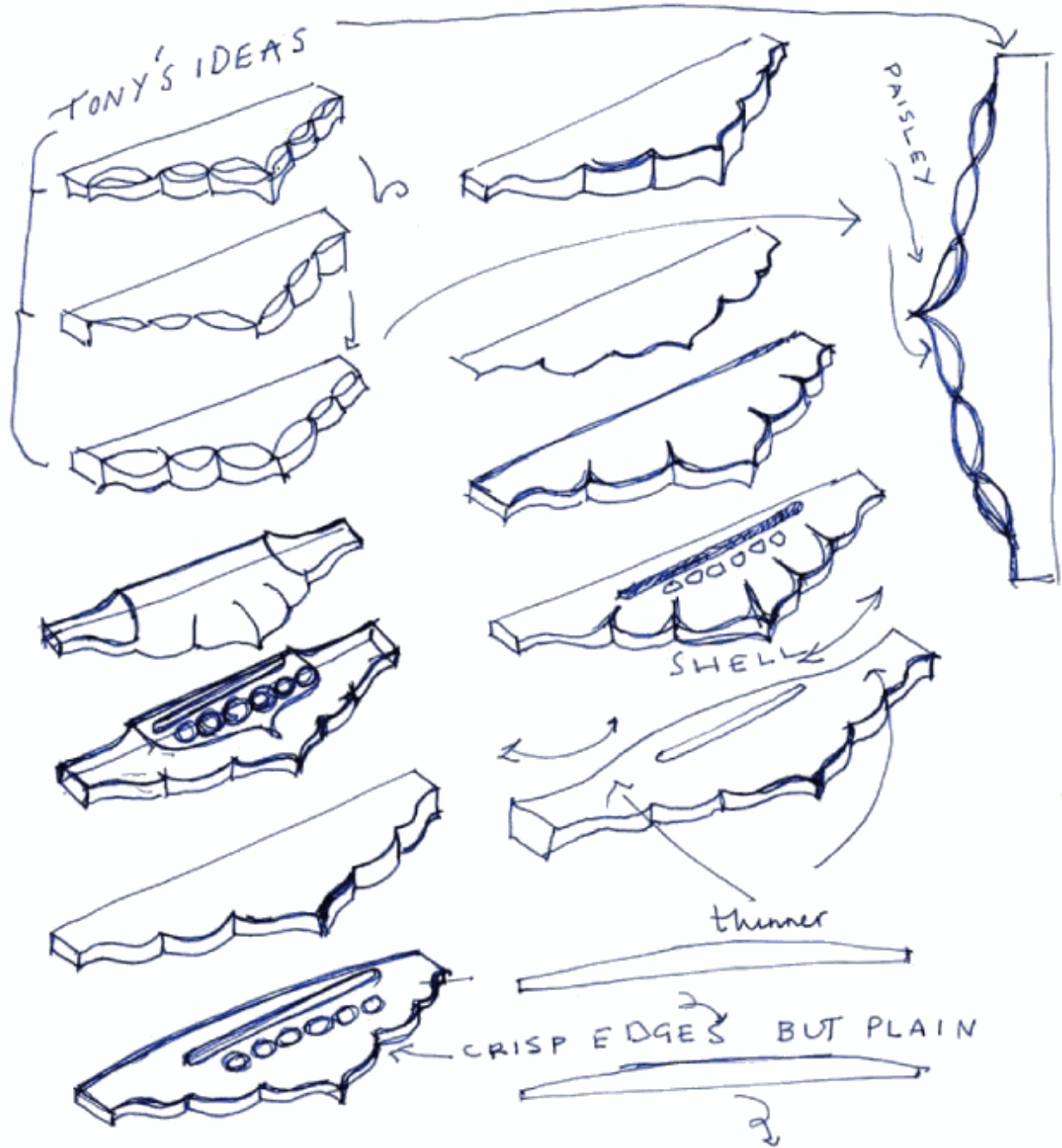

## Preparing to make the bridge



May 22nd: If I had been working with a normal length bridge blank then I would have left it square at this point but as I was using an ebony violin fingerboard blank I was able to get 2 of my bridge designs from the one piece even though that made it more awkward for setting up the bridge blank to plane a hollow into the gluing face. To get the bridge blank following the curved shape of the soundboard (made curved by the arched X brace inside), I had to first plane one side and one edge of the bridge completely flat and then thin the opposite face to about 10mm thick. I then used a scraper to try to scoop out a hollow on the flattest face and to try to get it to fit the guitar top curve. When getting closer to it fitting with only a few gaps, I started using a piece of sandpaper taped to the area it was to be glued to and rubbing the bridge gently on the actual curve of the



guitar *HOPING* that it would sand itself into the same shape as the guitar - was trying to sand it in a lengthwise direction and *NOT SIDE TO SIDE*. Worked a bit but not satisfactorily so think the method of bending the bridge over a drill bit in the vice, in similar way to planing the curve on the interior braces would be the best idea. Gave up a bit at this point and moved on to the decorative curved shape of rear of bridge



## Routing out saddle slot on bridge



May 23rd: Carved the bridge curves in the same way as headstock with a protective break out block at back edge. Used a gouge to carve the curves but found as was ebony i was working with there were lots of bits chipping off and was having to superglue them a lot. Decide that the front face i was cutting into would be my good edge to be glued down to guitar as this was the easiest edge to ensure no breaking out of the wood - the edge on the oppoposite face was just chipping away as though the wood was brittle. Quite a large bit came off with the gouge but was ok as knew this was the upward facing edge that would be reduced and rounded. The bridge was also not symmetrical at this point so i had to redraw the design on and mirror it exactly and then used a scraper as shown to define the roundness of the curves. Next was the 3mm saddle slot routed with aid of a wedge as shown below. The saddle slot took a good 4 or 5 routing sessions and was important to wear saftey goggles and make sure jigs were clamped to drill table well. Also to keep fingers away from router bit! Left about 3mm of ebony under where the saddle will sit.



## Saddle positioning and scale length

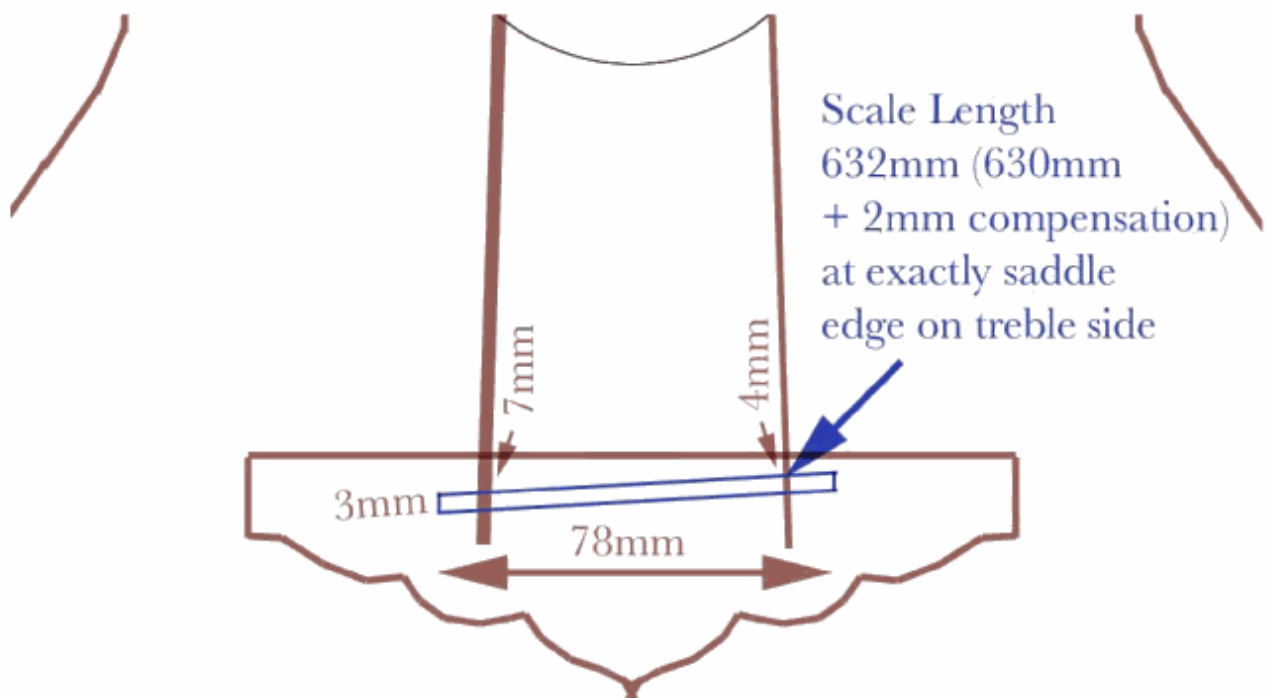

## Bridge pin hole spacing

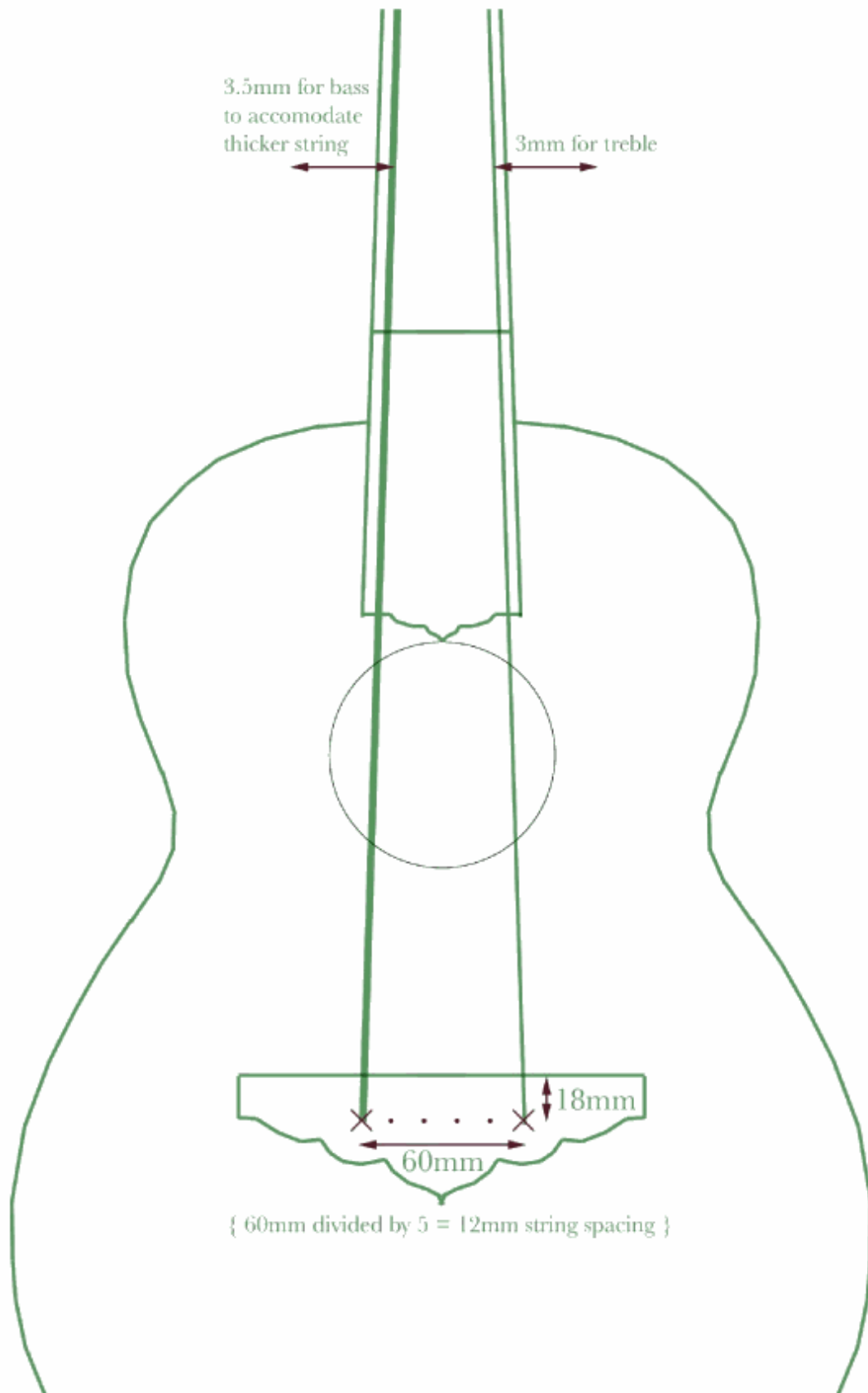

## Drilling bridge pin holes and thinning wings



May 24th: After getting saddle slot routed I then moved onto use a 4.5mm brad point drill bit to drill out the six bridge pin holes as worked out according to the diagram on the previous page. The brad point drill bit is used to ensure that the drill can be lined up exactly and will not veer off position.

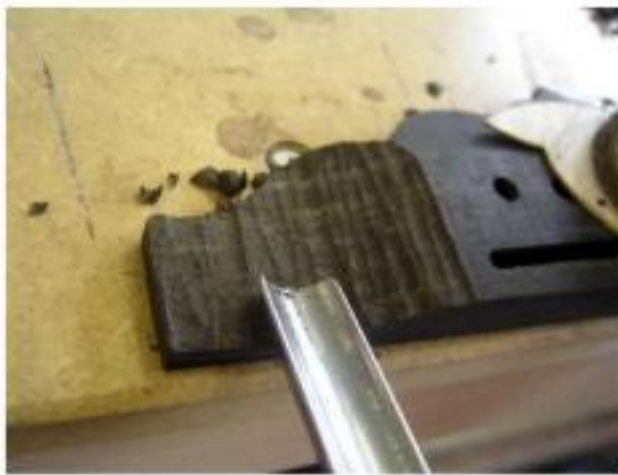

May 27th & 29th: With the saddle slot and pin holes drilled out, I now had to try to concentrate on shaping the bridge taking into account its weight and stiffness. Made a curved sanding block as shown to left to try to make the curve more close to a real circle than just an estimation. Once had wings looking interesting, I then block planed down the curve from bridge centre high spot of 9 to 10mm down towards the wings. This began to look quite nice now although it also became more obvious that I was going to lose the sharp distinction between the wings and the top plateau of bridge. Didn't mind this as quite wanted to make a flat looking bridge anyway so just tried to make the area of the plateau flow more onto the wings as though one single surface. This also made the bridge a lot lighter so was a good thing. To make a bridge like this look more interesting I could have done some carving, possibly a design with some foliage or something? Also thought of inlaying 2 abalone hearts on



bridge (next page) though time-wise I don't think I will manage now. This would have been really nice if had done the same on the fingerboard as I had planned at one point.



*Bridge abalone inlay idea*



*Idea i had as a nice decorative feature but didn't have time to do!*

## Preparing for gluing bridge to guitar body



May 30th: Today I began by wet sanding the guitar top with micromesh 2400 and this started making the guitar top seem more smooth and flat and ready to take a more mirror shine. With the bridge almost finished I then had to fit it better to the body shape so I tried the rubbing on sandpaper method on top of the guitar bridge position on the lower bout. As I went on with this method I started thinking of alternate ways of getting the sandpaper to dig deeper and make the curve more curved. I figured layering three sheets of sandpaper was an idea and it worked a bit as well. Bill then helped here by telling me where I needed to remove a bit of material with a stanley blade used as a scraper and this worked great. With the bridge fitting the area I then had to position it by aligning it using the metre rule aligning the 632 (630 + 2mm compensation) on the first third of the saddle position (leaving two thirds at the rear for the curve down of the string dropping to the pins). Once the bridge was in this position, I

also had to align it by using the metre rule to project the two outer string edge positions as they come from the nut down to the bridge and make sure the two projected lines were not veering off course off the edge of the bridge. I then had to further make sure of the alignment of the bridge by triangulating its



position by running a rule from each fret edge on both sides and measuring the length at where the rule was meeting the corner of the bridge. Once this was achieved I then did it all again to make sure of its accuracy. I then clamped the bridge in place and drilled 2 guide holes to insert drill bits to hold the bridge in position. When this was done I was able to remove the clamps and then sharp scalpel around the bridge perimeter very carefully until I felt I had gone deep enough to reach the wood layer and no more. Unfortunately here I went a bit off the rails and the scalpel slipped! So it carved out away from the bridge while leaning hard so made a bit of a mess of that area. In retrospect I should have just left the cut mark and cut back in towards bridge as think the polish would have filled in a scratch better than the way I done it of scraping back all the polish to the mistake line. Once I had scalpeled all around shape I then borrowed a chisel from Matthew and scraped away all polish in the area, so deep in fact that my bridge was almost becoming like an inlay into the guitar top!



## Gluing bridge and fitting bridge pins

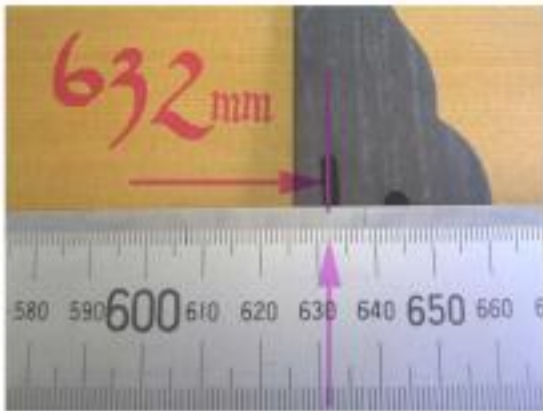

May 31st: Before beginning gluing bridge just made sure to double check that the 632mm mark was on the first third of the saddle and that the bridge corners triangulated correctly using a number of fret positions to ensure accuracy. When was happy with this put in two drill bit positioning pins and coated back of bridge with titebond and began clamping up. Mistake here was in clamping before triple check! I should have loosely put down bridge with glue on and shuffled around until it was spot on using the triangulating etc and



then clamped it down from that point on. As it was I think one of my drill positions was out of alignment so when i followed the drill bits alone the bridge ended up just a fraction of a mm too forward and so the mistake i made with the skewed off scalpel at the back only was made worse as the



bridge was just slightly pulled away from the scalpel line! Clamped it up with 4 long reach stewmac C clamps and one cam clamp for centre. Inside underneath bridge position I put my original



clamping caul for the bridge patch.

When dry the next day I drilled out the rest of the holes using the 4.5mm drill bit - a caul at the back would be good for drilling job to stop break out of the patch inside I then used the bridge pin hole reamer and reamed each hole until each peg was able to just sit into the hole and no

more. When this was done satisfactorily I then used a countersink to drill in a little 2mm recess into which the pins will sit.

## Using wet 2400 grit micromesh to flatten drop filled polish repairs

June 2nd & 3rd: With some 100% Vitapol I tried to drop fill in carved up area of the soundboard on the bass side of the bridge. This began to make it look a lot better and I cleaned it back every few hours and re-applied more drop fills of polish and did this several times. At one point Bill suggested leaving a little in a lid to evaporate off a bit to make it more like honey so it would fill a hole better. This worked great but I made mistake of thinking if I left it even longer (a few hours) it would go better but instead it was a bit like putting putty on and made a huge mess of the edges of the bridge which was quite hard to clean off - in fact for a while the sides of the bridge started looking worse than the original problem! After some drying time, I then 2400 micromeshed the bridge edge at the soundboard using a small cork sanding block and water. As finish got finer could see lumpy areas around bridge edge due to me overdoing it with the thicker vitapol. Just had to try to keep focusing on bringing it all flat with rest of soundboard. This took some time and in the end began to look acceptable although the bridge edges now seemed to be caked in polish and made it all look a little uncrisp. Decided to tackle that next using a scalpel blade to scrape off most of the lumpy polish on the edges (see photos at bottom of page 133 in next section GUITAR SETUP).



## *Guitar setup*

## Stoning and profiling frets

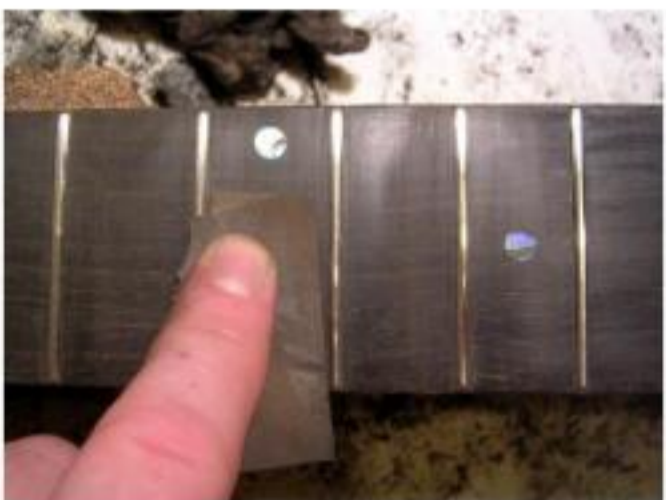
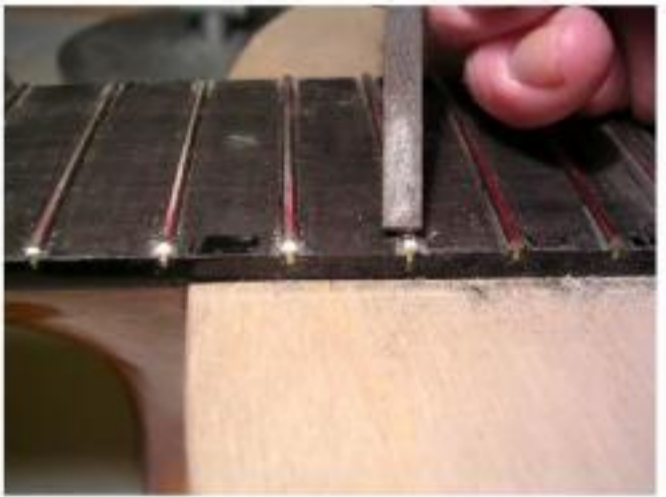
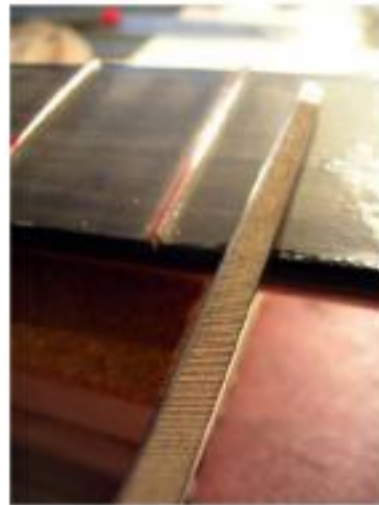
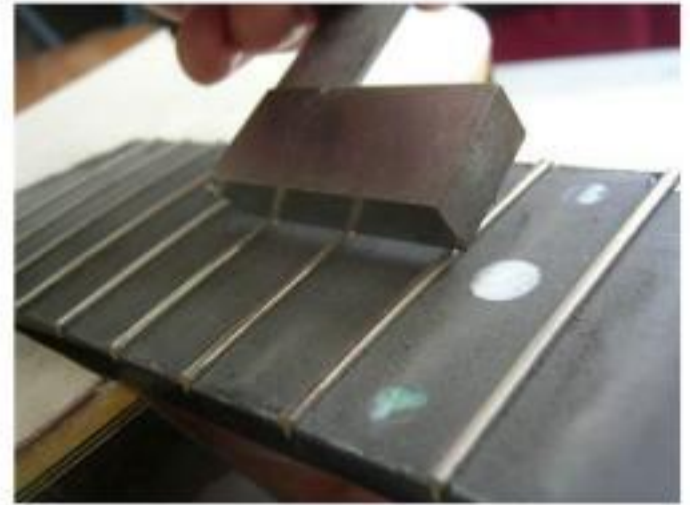
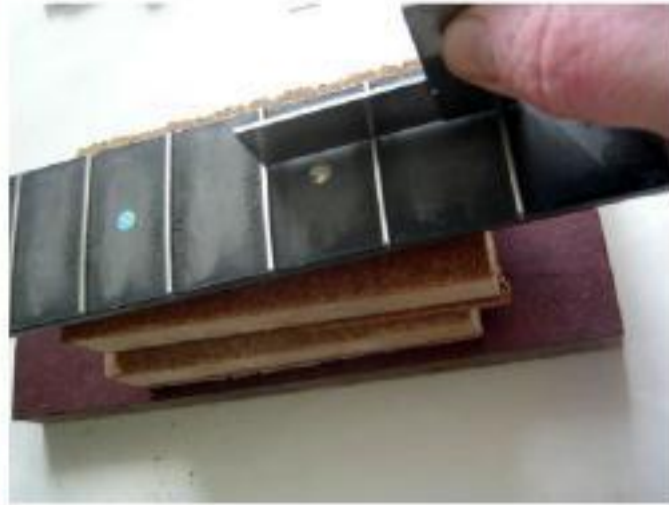

May 28th: One image I missed out here was using the stanley blades as scrapers to clean up and take away any scratches from the ebony inbetween the frets. This was near end pf job and went over full fretboard more than once to get it looking scratch free. Perhaps went a bit deep in some areas.

## Making Nut & Saddle



Jun 4th: To begin with I got the bottom face of the nut square and the top edge. I then thinned back the front edge with the sanding block jig I made and used a half pencil to transfer the curve from the frets onto the actual nut. This helped a lot in forming the shape of the nut. This was similarly true of the saddle - held saddle up to the fingerboard end and traced the line off the frets again. I then was able to refine the shapes of the bridge and nut to match the guitars fingerboard.

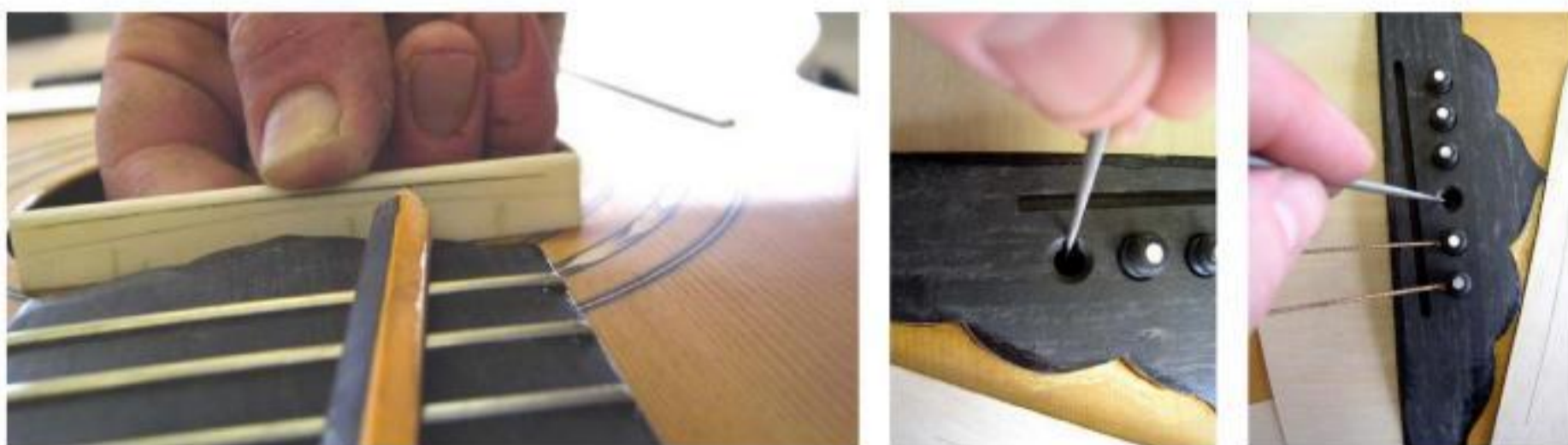

I then used a needle file to file a groove into each pin hole to allow the string to gently curve up from the hole gently preventing strings from breaking along a sharp corner. The groove also helps the string fit into the hole more solidly. When this was done I also put my hand inside to make sure the 'ball-ends' of the strings were sitting in such a position that they were definitely being gripped by the pins. Next trying to make sure guitar plays good and looks ok for concert.

*Final touches, burnishing, tru & lemon oiling before concert*





*Final burnishing before stringing up*



## *Scratchplate ideas*

## Scratchplate ideas 1

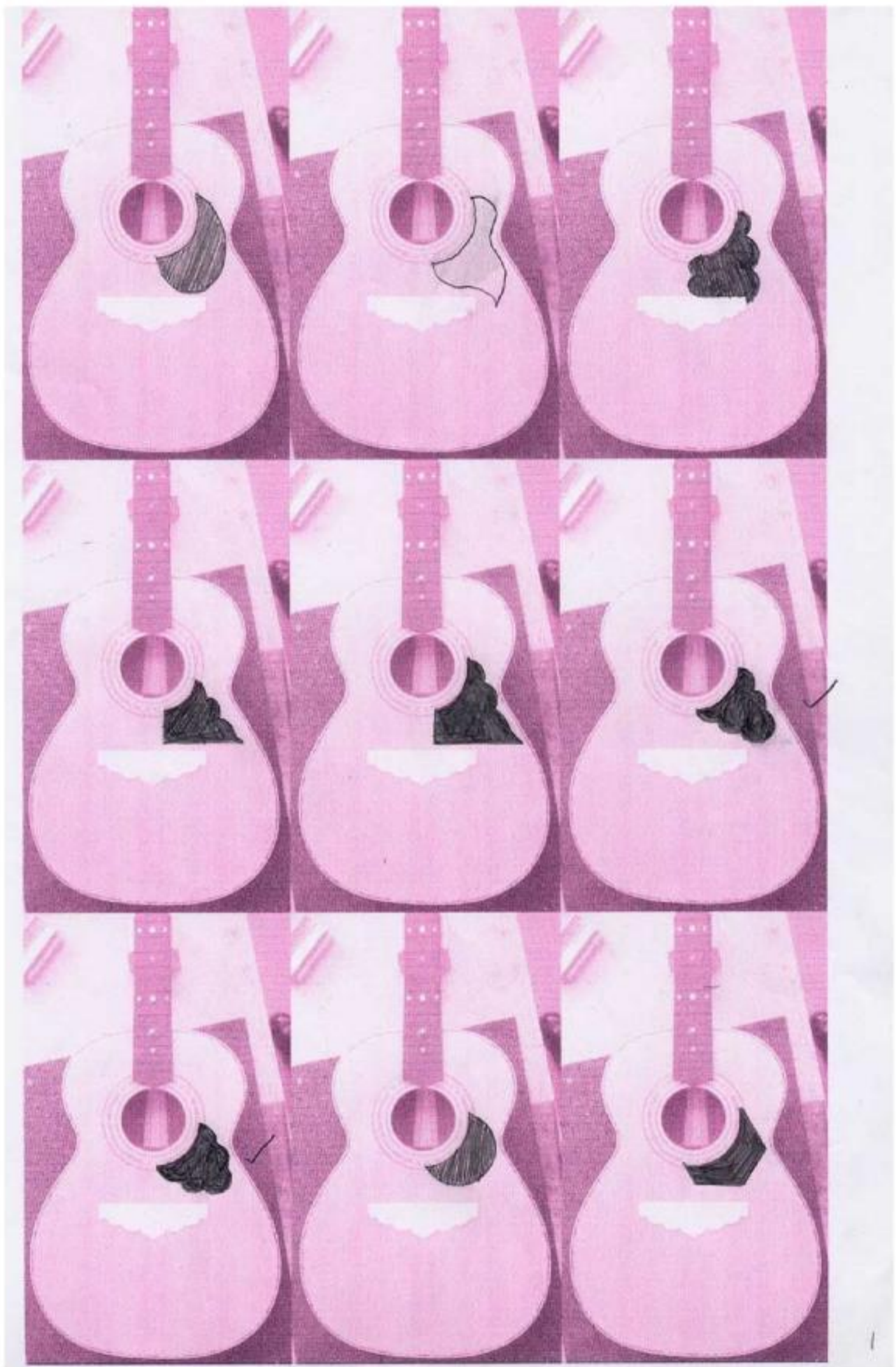

## Scratchplate ideas 2

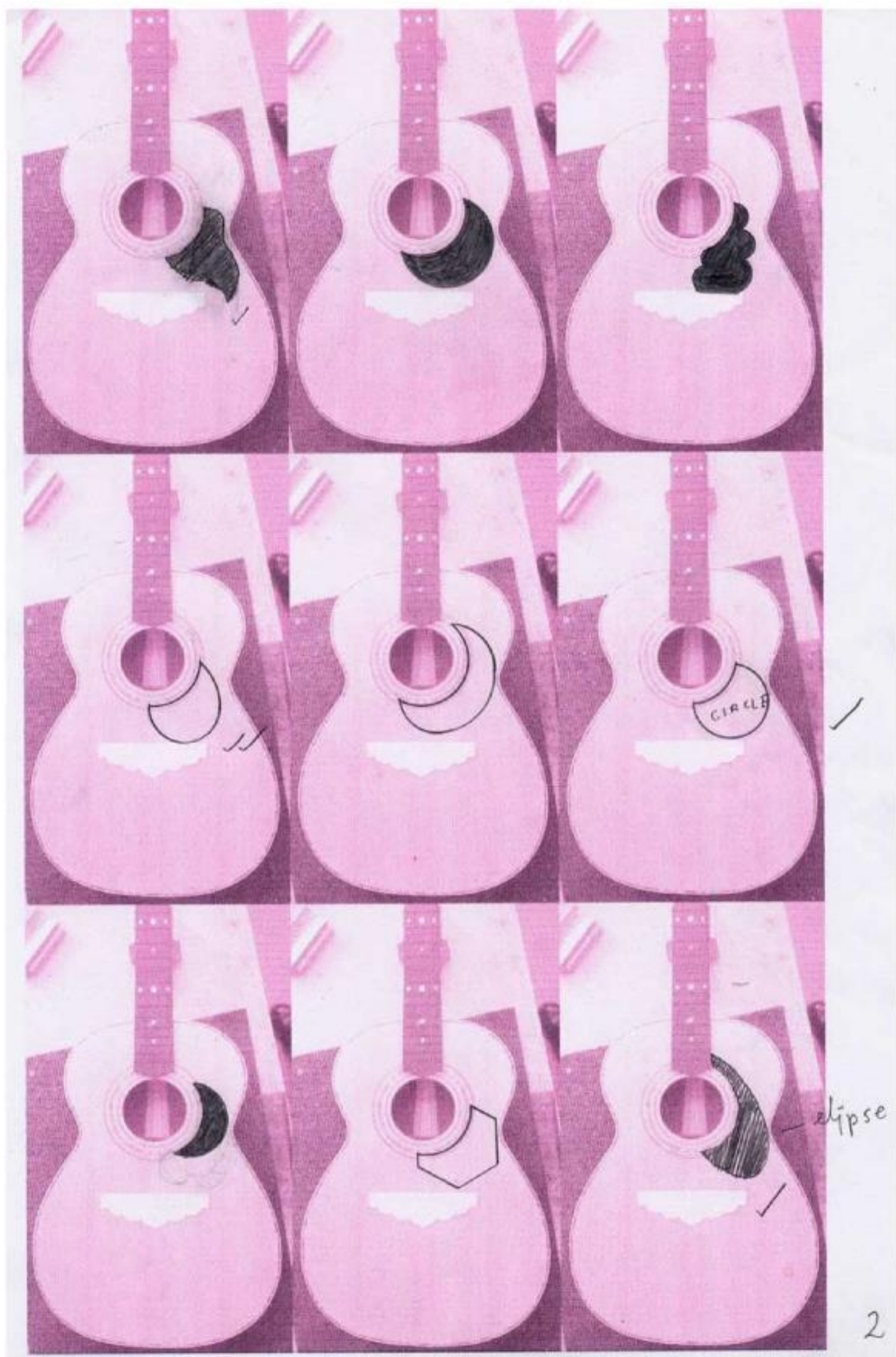

### Scratchplate ideas 3

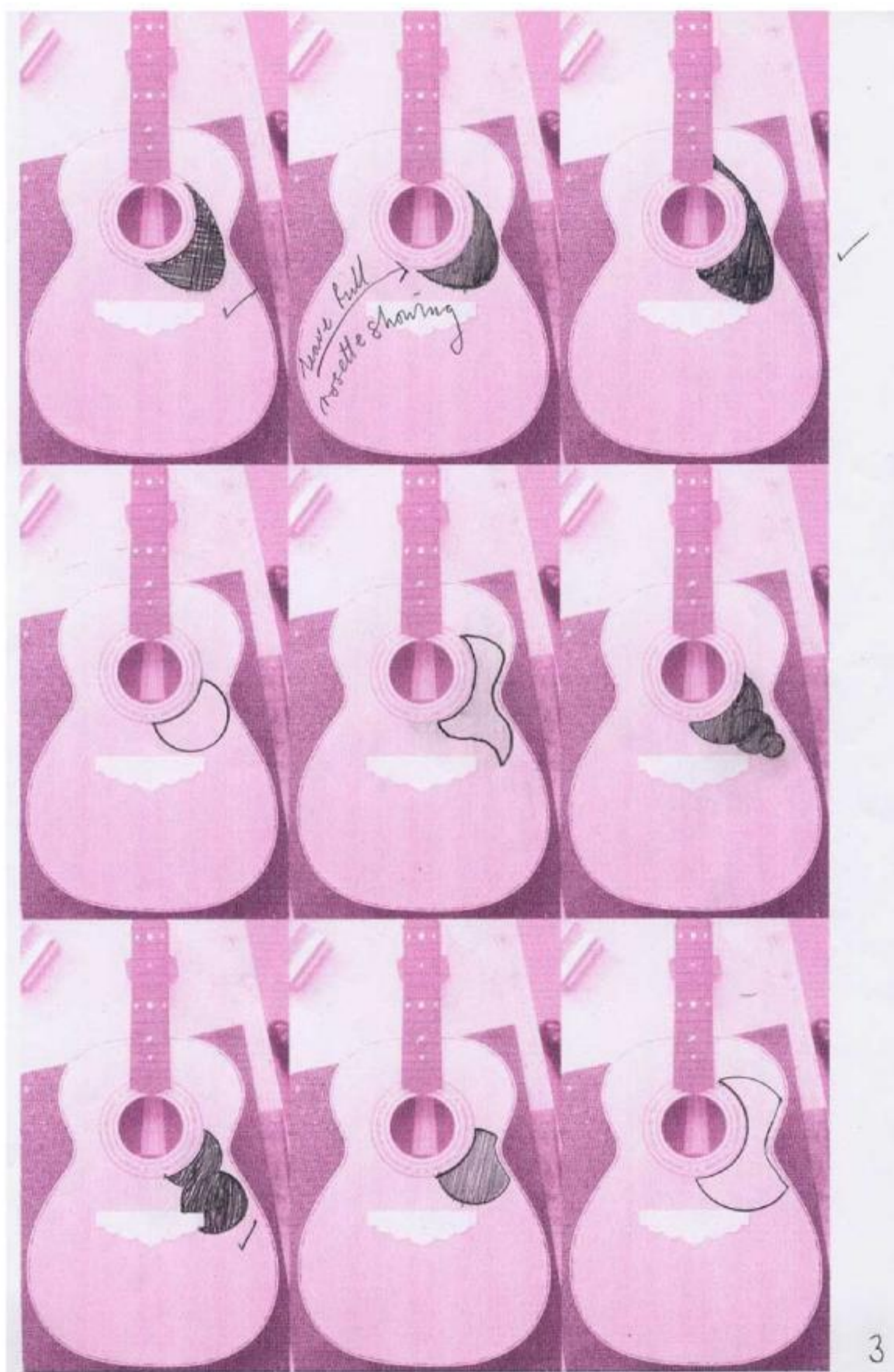

## Scratchplate ideas 4

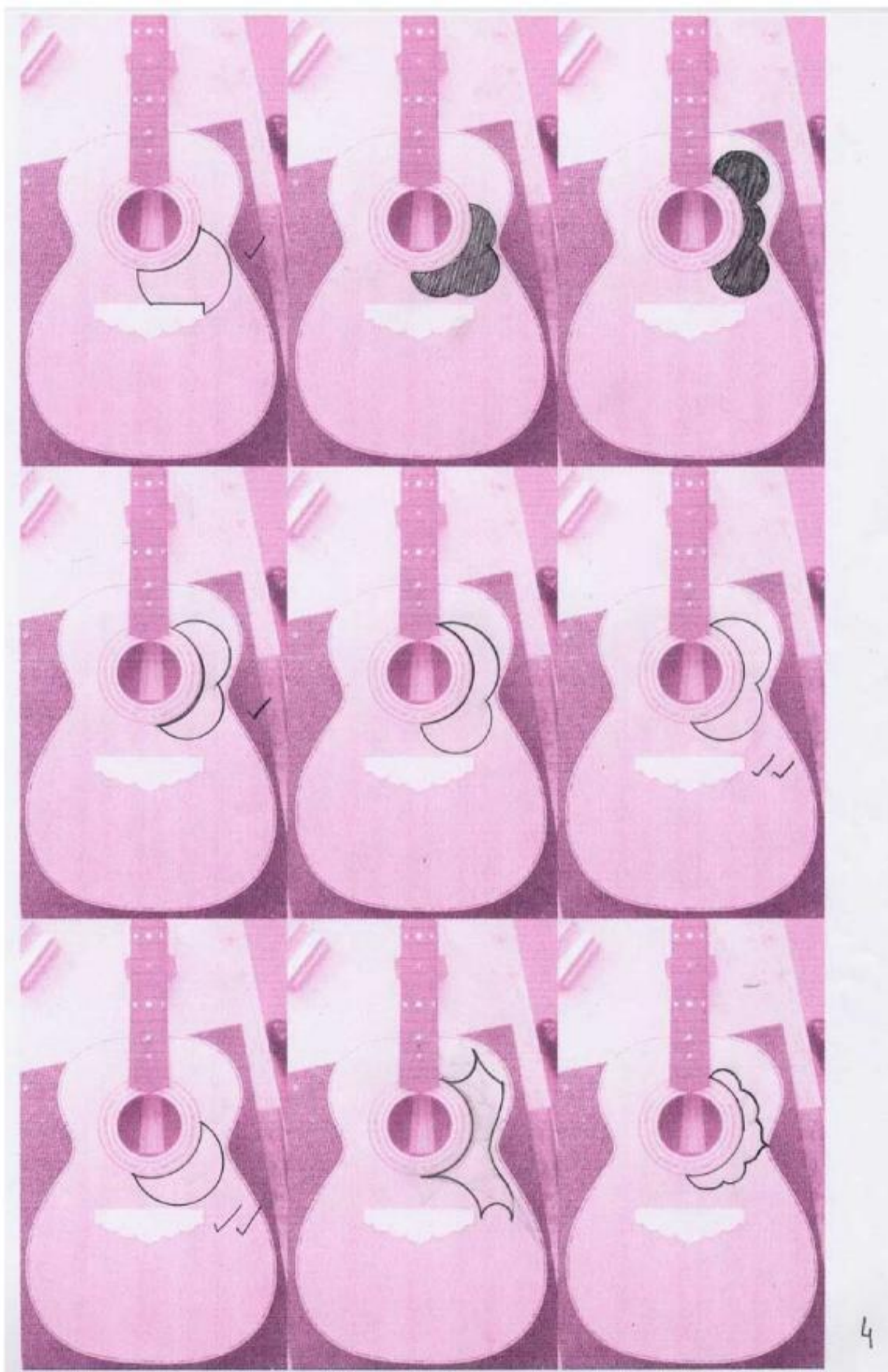

## *Appraisal of finished guitar*

## *My appraisal: Playability*

*Fingerboard is exactly as I had decided on: 47mm at nut and 57 at 12th fret. Feel this is good for fingerstyle as gives more room for fingers to clearly hold down and pluck individual notes on strings. Neck perhaps still a bit chunky at back at nut end*

*Strings still a little high at time of concert I think. Hard to fret on an F barre chord after the nut so will maybe need to lower nut action just a small fraction.*

*Very easy to tune with good quality Rubner machine heads.*

*Feel intonation is very good overall – harmonics on 5th, 7th, 12th and 19th all seeming to be matching fretted notes well.*

*String separation is good – Worked this out before slotting nut and tried to take account of differences in gauges of strings. Perhaps though strings could have come in from edges of fingerboard 1mm more at both bass and treble sides. This though would also have to have been the case with the bridge pin holes too so would have been 58 or 59mm from bass to treble pin centres at bridge instead of 60mm.*

*String relief seemed quite good. There's a bit of play in the action when fretting a string at both ends of fingerboard and tapping in the centre.*

*Perhaps slightly buzzy around nut area which may just be to do with nut being too high making it difficult to push the strings fully down and also the nut slots being slightly deep and so gripping the strings a bit too much. Going to lower nut a little and see if this changes. If not may need another light stoning and profiling of frets.*

*String height seems good to me and correct at the 12th except perhaps at the nut where it just seems a smidgeon too high which is fixable.*

*No sharp frets and nut has been shaped nicely and rounded over so as not to catch the fingers of the player.*



## *My appraisal: Tone/Timbre:*

*Guitar is loud to booming. Rich even sound with nice bass and mid-range sustain and reverberation.*

*String sustain times are:*

*Bass E - 10 secs A - 14 secs, D - 12 secs, G - 12 secs, B - 7 secs, Treble E - 7 secs*

*Evenly balanced warm sound from guitar with some brightness at treble side that manages to rise above volume of mid and bass range.*

*Seems to resonate between F and F# after the bass E and also F and F# in the next octave up though not the treble octave. Perhaps this explains why there is less sustain in the treble strings. Perhaps the top needs to be slightly more stiff at the treble end of bridge and for the top to be more thick on that side to allow the high frequency to resonate it?*

*Chords sound good all around guitar with a slight distortedness perhaps due to the treble notes not singing out for as long as the lower frequencies. The reverberation probably plays a part in this distortedness too. Not a bad thing.*

*Fretting seems to be fine across the fingerboard except on the first fret after the nut and here i think this just because I suspect the nut needs to be lower.*

*The guitar body is about 1 inch or so longer than an average OM or 000, and the soundhole is also further up the body and these two aspects mean the guitars lower bout area around about the bridge is larger and so perhaps this make it more like a Dreadnought / Jumbo guitar for loudness but think maybe its more rounded shaped bouts give it a more rounded sound. The top could perhaps be improved by more attention being paid to keeping an eye on the thickness and making it consistent. This guitar top has too many a variety of thicknesses for it to be a fully useful instrument to refer to when making the next guitar.*

*I think all in all the harmonies work well as the fret positions seem mostly to be bang on the mark, although I am not a musician and to fully get a good idea of whether the notes on the guitar are in harmony it would be very useful to speak to a professional guitarist more especially a classical guitarist who would have a fine ear for recognising these very subtle aspects. Ideally I'd like to be able to be more confident about these things over time myself as my experience of making instruments hopefully grows.*

*The treble strings are a bit weaker than the bass and sustain less so perhaps their is a string 'choking' issue at the nut where maybe the resonance is being absorbed by some unnoticed aspect of the set up but equally as mentioned this may be to do with the thickness of the top or of the bracing for the top.*

## *My appraisal: Next Guitar?*

*What I've learned from making this guitar is that the most important aspect of the finished instrument is its sound.*

*All the other aspects, such as the quality of the materials, the strength of the instruments construction, the durability of finish used and its final aesthetic appearance are all secondary to the sound.*

*I have really enjoyed adding my own shape influences into the design of this guitar but feel with the next guitar I should focus more on quality of sound produced and so focus less on the design side until I have a better understanding of how sound is produced in a stringed instrument. This makes sense in terms of time.*

*Also another thought in regard to this is that the audience should be listening to the sound of the instrument so making it have a bit more of a subtle appearance is probably better for the performer as the audience will have a greater focus on the music and the sound and the player than on the look of the instrument.*

*Playability wise think I would like to look more at neck shape and feel and also where knee position might be in relation to the guitar waist and how this affects where the fingerboard sits in relation to this. Where is the 14th fret position in relation to centre of body etc. Maybe could make up some quick cardboard guitars to test ideas out quickly.*

*On aesthetics and durability realise that french polish is not as hard wearing as the more modern laquers available for finishing guitars. To compete with professional guitar makers I would have to start using laquer to bring my guitars up to the standard that is expected in terms of durability.*

*Me with finished Guitar!*



*Photo by George McBean*

## *Useful Addresses*

## FINISHES

1

Smith & Rodger Ltd, 34 Elliot Street, Glasgow G3 8EA  
TEL: 0141 248 6341,  
EMAIL: [info@smithandrodger.co.uk](mailto:info@smithandrodger.co.uk), [www.frenchpolishes.com](http://www.frenchpolishes.com)

## WOOD

1

Madinter Trade, S.L. - Mercurio 11, 28770 Colmenar Viejo, Madrid, Spain  
Tel: +34 91 846 3679, Fax: +34 91 845 4906  
[sales@madinter.com](mailto:sales@madinter.com), [www.madinter.com](http://www.madinter.com)

## MACHINE HEADS

1

Thomas Rubner GmbH, D 08258 Markneukirchen, Gewerbepark 16  
Telefon: +49 37422 / 2540, Fax +49 37422 / 6000  
E-Mail: [rubnergmbh@t-online.de](mailto:rubnergmbh@t-online.de), [www.rubner-markneukirchen.de](http://www.rubner-markneukirchen.de)

## TOOLS

1

Gerry and Carol Dawson, 22 Marlpit Lane, Seaton, Devon, EX12 2HH  
Telephone: +44(0) 1297 23826, Mobile 07971521744  
Email [info@secondhandtools.co.uk](mailto:info@secondhandtools.co.uk), [www.secondhandtools.co.uk/](http://www.secondhandtools.co.uk/)

2

The Old Tool Shop, Phone UK: 01302 537906  
E-mail: [barry@danwhin.fsnet.co.uk](mailto:barry@danwhin.fsnet.co.uk)  
[www.theoldtoolshop.fsnet.co.uk/](http://www.theoldtoolshop.fsnet.co.uk/)

3

The ToolPost, 35 Brunstock Beck, Didcot, Oxfordshire, OX11 7YG, UK.  
phone - 01235-810658  
[enquiries@toolpost.co.uk](mailto:enquiries@toolpost.co.uk), [www.toolpost.co.uk/](http://www.toolpost.co.uk/)

4

Antique Tools, 78 High Street, Needham Market, Suffolk, IP6 8AW, England  
Tel +44 (0)1449 722992, Fax +44 (0)1449 722683  
E-mail [tony@antiquetools.co.uk](mailto:tony@antiquetools.co.uk), [www.antiquetools.co.uk](http://www.antiquetools.co.uk)

## INLAY MATERIALS & VENDERS

1

Anita Marquetry

Units 5-7 Ddole Enterprise Park, Llandrindod Wells, Powys, LD1 6DF

Email: [info@marquetry.co.uk](mailto:info@marquetry.co.uk), [www.marquetry.co.uk/](http://www.marquetry.co.uk/)

## PLANS

1

GUILD OF AMERICAN LUTHIERS, South Park Avenue, Tacoma, WA 98408, USA

Phone and Fax : 253-472-78538222

[www.luth.org/plans/bp.htm](http://www.luth.org/plans/bp.htm)

2

Edinburgh University Faculty of Music

St Cecilia's Hall, Niddry Street, Cowgate, Edinburgh EH1 1LJ

[www.music.ed.ac.uk/euchmi/uwl.html](http://www.music.ed.ac.uk/euchmi/uwl.html)

## USEFUL

1

Musical Instrument Makers Forum - Useful links page for luthiers

[www.mimf.com/link2.htm#tools](http://www.mimf.com/link2.htm#tools)

2

Online gallery of historically significant musical instruments

University of South Dakota, 414 East Clark Street, Vermillion, SD 57069, USA

National Music Museum ~ [www.usd.edu/smm/](http://www.usd.edu/smm/)

3

William C. Kelday

Guitar Maker based in Fintry Scotland

[www.keldayguitars.com](http://www.keldayguitars.com)

4

Stringed Musical Instrument Making Course

Anniesland College, 19 Hatfield Drive, Glasgow G12 0YE

[www.anniesland.ac.uk](http://www.anniesland.ac.uk)











# *Major Guitar Repairs*

# Crack repair

## Tools & materials used:

pencil  
3/4 inch firmer chisel  
small sanding blocks  
cam clamps  
mdf clamping cauls  
bench vice  
engineers square  
junior hacksaw  
6 inch rule  
hot water  
a cloth  
masking tape  
a double electric hob  
hot animal glue  
an aluminum pot  
a jam jar  
a small flat brush

## Repairing a crack on a guitar soundboard



Sep 5th: This guitar is a fairly nice shape though it has been banged about so much that it is falling apart. The fingerboard is loose from the body though it does seem to be ebony as there are large chips out of it in several places and the wood remains black in these areas. The back is already off and seems to be nice enough solid wood. The sides too are nice wood though they are massively split along the middle of their length. The neck however has been painted a

color to match the ribs and back but it is obviously painted and not very nice.

The first repair I have to attend to on this guitar are two parallel cracks about 1 1/2 inches apart along the right



side of the lower bout coming from the very edge of the soundboard going about 3/4 of the way along towards the waist. These 2 cracks seemed to be quite straightforward - all the wood was intact and the areas split seemed to fit very well back into one another without too much further damage. They were also just recently cracked so they did not need to be cleaned out in the same way that they might have been on a guitar that had been left in a damaged state for a long period of time. I prepared some hot animal glue and while this was melting I set up an assembly using some blocks of mdf to act as clamping cauls to keep the cracked surfaces in alignment - and 2 cam clamps to hold these cauls firm. I also prepared some masking tape for the areas where the cauls would touch the guitar just in case the cauls become glued to the area I am working on.



With the glue now hot I opened out the 2 cracks a little and brushed in the hot animal glue and quickly re-

set in position. I held for a minute or two but then applied the masking tape over the cracks inside and outside and applied the clamping cauls over the taped areas and clamped in place. A full dry run beforehand would have been good here as I feel I wasn't fully sure how I was going to clamp the assembly up until I was actually doing it. Dry run next time to make sure.

## Making up studs to brace crack

Sep 7th: Yesterday went through this process of making up the repair studs but messed it up a bit so redone it today a lot better than first attempt.



Today I got a nice flat piece of pine about 25mm x 100 x 500mm. Initially I squared off the 25mm edge to give myself a nice flat edge to work along and I then double sided the full way along, a nice piece of douglas fir spruce, normally used for bracing a guitar. This piece was around 400mm long and about 7mm wide. Height wise I had to reduce the piece down to about 1 ~ 2mm

with the number 5 1/2 plane. Once I had established this height, I then tried to subtly chamfer and round off the edges along the whole length on both sides to give a nice curved appearance to the studs when cut. The studs must follow the same rules as the soundboard itself and have quarter sawn grain perpendicular to the surface to be glued onto. Also the grain direction of the studs must go cross ways to the grain of the soundboard or piece to be joined ~ this is to give the joint strength.

With the length of douglas fir now rounded off, I took the engineer's square and marked on the length of each stud which was to be 10mm each.

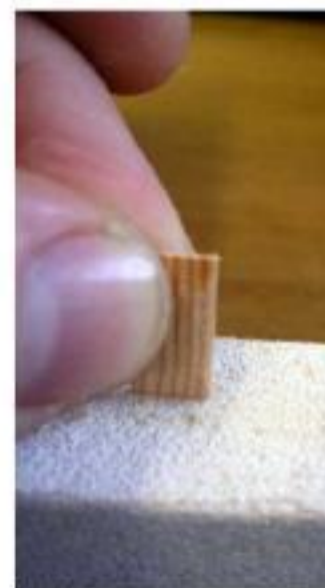

What I did differently this second time trying to make the studs was to cut right through and free up every stud

using a junior hacksaw, before going onto the chiselling stage. The first time I think I didn't seem to get the angle straight so the studs ended up a mess. The only thing important with doing it this way was that the length of douglas fir was fully double sided from end to end onto the pine block, and not just partially. With the studs now fully seperated but still stuck down, I was then able to carefully chisel off and chamfer either end of every stud as shown above. After this each stud needed a light sanding to tidy them up.

## Gluing on studs



Sep 11th: With a good 20 or 30 studs made up, I was now able to move onto the next stage of studding the crack from the inside. Luckily with this guitar, the back was already off which made studding a lot easier than when trying to do the same job with only the soundhole for access.

To begin with I made a very small sanding block and sanded down the surrounding area of the two cracks to take away any raised area from glue or from broken fibres. After this I planned out the repair by laying the studs out about 10mm apart over both cracks. I decide to try to align the studs in such a way as to make a neat and presentable job of the repair. With the job planned out, I brought the pot of hot animal glue to where I was working and gradually studded both cracks. I used the end of the scalpel to lift each stud up and then I brushed on some hot glue quickly then put the stud back in place immediately and pressed firmly with the scalpel tip for about a minute. Next I would take brush with hot water blotted off and clean up around each stud, carefully trying to avoid unsettling the studs sitting in place ready to be glued.



In the end, I made a not too bad job of this but maybe one or two of the studs were not quite on the 10mm spacing but mostly it looked quite nice and more importantly it seemed to have firmed up the cracked area quite well.

I sanded around the area of the 2 cracks on the outside a little bit but it really didn't need much work as most of the fibres in the wood had remained intact.

# Splinting a crack

## Tools & materials used:

small pieces of cedar  
scalpel  
sandpaper  
measuring jug  
sheets of paper  
a household iron  
cam clamps  
mdf clamping cauls  
3/4 inch firmer chisel  
Potassium Dychromate  
Oxalic Acid  
various powdered analine dyes  
smith and rodgers vitapol polish  
a small pointed brush  
a double electric hob  
hot animal glue  
an aluminum pot  
a jam jar  
a small flat brush

## *Infilling two wider cracks on the soundboard with similar wood*



*Sep 11th: Today I had to repair 2 cracks that started underneath the middle of the bridge on the same guitar and run out from there about an inch and a half back towards the lower bout end. The cracks were a little opened up and also a bit mucky so I was told to try to widen them a little using the scalpel to try to even them out in order to plug them with a splint of wood. I used the scalpel and then a small piece of sandpaper to try to even out the cracks a bit more.*



*Next I had to take a plane shaving from a 'like for like' piece of cedar. In actual fact it was a spruce top on the guitar but it was a dark spruce, perhaps due to the age of the wood, so the cedar was a better colour match. Important here too was making sure that the splinted piece matched in terms of grain direction. The plane shaving was curled so I had to soak it in water then iron it out flat again. I made a few shavings soaked and ironed them in order to give me a few in case I made any mistakes as the shavings were pretty brittle. Once flattened I cut a small section to match the areas to be splinted and tried to shape them and feed them into the slot that they would go right through the guitar and fill up the crack. This worked with one crack, but the other crack was wider and for this I needed to take a thicker sawn section of cedar and thin it to fit the slot more accurately. Once I had got the 2 pieces fitting I then prepared some more mdf blocks to help align the 2 cracks from both sides with the rest of the soundboard. Once these were prepared and I had done a dry run with the clamps, I brushed hot animal glue onto the 2 splints where they had been put in place, wiped clean with a very slightly damp cloth, then clamped up the whole repair using 2 cam clamps.*



## *Cleaning up and studding two cracks from inside*



*Sep 13th: Today I took a sharp 5/8 inch chisel and cleaned off the inside and outside of the 2 splint repair and then took the small sanding block and tried to just level off the surface in preparation for studding. As the 2 cracks were very close together, 3 studs were sufficient to secure the crack, so I followed the same procedure as previously and did a dry run with 2 cam clamps and this time a cork block which would go in place over the studs once glued in order to help keep the alignment of the soundboard surface, which seemed to be slightly off due to the closeness of the 2 cracks.*



*After trying out I went ahead and glued on the studs with the animal glue and cleaned up around about with some hot water on a brush and then clamped them in place with a cork block on the inside and a normal block on the outside. In retrospect - perhaps a cork block on the outside would have been good too to protect the surface of the guitar while it's being repaired ~ no sense in damaging the guitar more while trying to fix it!*

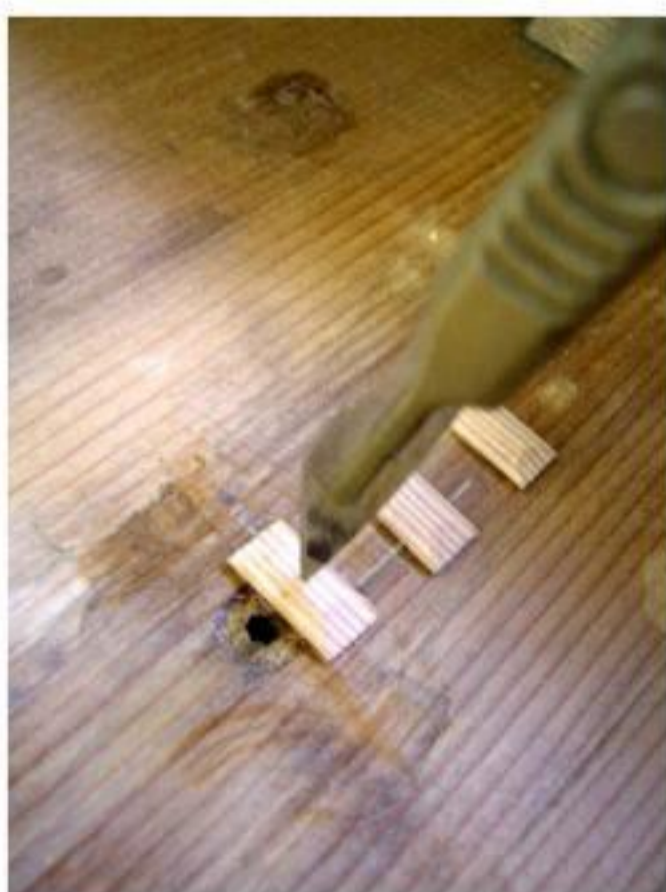

## Trying to disguise infilled areas on soundboard



Sep 20th: With the 2 splinted cracks now studded, I had to try to disguise the repair and refinish it to attempt to make it as invisible as possible for the would be customer. The cedar from which the splints were made appeared to be quite a bit lighter than the



orangey finish on the guitar soundboard so I decided to try the 2 'ageing' chemicals ~ Potassium Dichromate and Oxalic Acid. Both of these are poisonous so it's very important to wash hands after



use and possibly even wear gloves if there's a chance of irritating skin. The Potassium Dichromate darkens and yellows the wood gradually depending on how many layers are applied. The Oxalic Acid acts to neutralise the first chemical and stops it from breaking down the surface too much.

Unfortunately on the first application I think I went over the score with the Potassium Dichromate and the splints went almost rosewood colour! I had to leave it to dry out and then scraped away again to reveal the lighter color of the splints. The whole area was



looking very light now in comparison with the rest of the soundboard and so I applied some more Potassium Dichromate around and about trying this time to just skim over it with one thin coat. Again it went really dark. When I went to carefully scrape off the darkened areas on the splints for the 2nd time with the scalpel blade it appeared to be that the darkened wood

on top of them was almost powdering away. A possible explanation for this would be that using the cedar on a spruce top may not have been a good idea as the Potassium Dichromate may have darkened a piece of spruce just enough to match whereas the darker cedar maybe went further darker still. Felt too that maybe the powdering away of the splints was an indication that I should possibly start from the beginning again and refill the cracks with some newly prepared splints. I decided not to however and instead went on and lightly sanded and cleaned up again. I thought this time I would have a go at using some coloured dyes mixed with some polish to an approximate colour and use this to try to disguise the splint. Again I didn't do a great job and had to wipe the whole lot off almost instantly. No third time lucky with this repair! In the end I didn't make too great a job of this one but I think I know now that is why it is important to get experience of this process with less valuable instruments where mistakes can be made and learned from.

# Broken headstock

## Tools & materials used:

cabinet scraper  
400 grit wet and dry sandpaper  
bar of soap  
sanding blocks  
a small pointed brush  
cam clamps  
phone directory caul  
mdf clamping cauls  
3/4 inch firmer chisel  
various powdered aniline dyes  
smith and rodgers vitapol polish  
cellulose terracotta red paint  
cellulose thinner  
a wide salsa jar for mixing paint  
superglue  
a double electric hob  
hot animal glue  
an aluminum pot  
a jam jar  
a small flat brush

## Repairing a broken headstock

Sep 20th: This repair involves fixing a broken headstock which has broken off part the way along the neck of the guitar underneath the fingerboard. This break has also separated the fingerboard cleanly away from the neck and the guitar body.



For the the break in the neck I did a dry run with an mdf clamping caul which was covered on one side with double sided tape with the backing seal left intact. The backing tape was left on so that when it is clamped against the fingerboard side of the neck, the animal glue cannot adhere to the surface. On the underside of the neck break I used a phone directory coverd in masking tape which should take to the the rounded shape of the neck quite well and allow both surfaces to be clamped. I decided to use 2 cam clamps again however I also opted to use a big G clamp as well as thought that maybe it could use more tension than the cam clamps alone could manage. Perhaps I could have made this 3 G clamps instead and left out the cam clamps as strength here in a neck split is more important than delicacy which is what the cam clamps are maybe better used for. I applied some hot animal glue onto the sheared off area of the



neck and very quickly put the two surfaces together, making sure to push the two halves into each other so that the fibres of the 2 pieces of wood merged back together properly. Once this was done I tried to quickly wipe away some of the glue with a hot wet cloth and then clamped the whole repair together as firmly as possibly.



neck and very quickly put the two surfaces together, making sure to push the two halves into each other so that the fibres of the 2 pieces of wood merged back together properly. Once this was done I tried to quickly wipe away some of the glue with a hot wet cloth and then clamped the whole repair together as firmly as possibly.

Sep 21st: the next day I had to then reglue the fingerboard onto the guitar. For this I did a dry run to test out how to go about attaching it firmly all the way along. At the nut end it was the same as for gluing the neck break - the mdf block with the glue resistant covering was placed face down on the fingerboard with the masking tapecovered phone directory placed underneath to take the round neck shape. On this occasion I used 4 cam clamps which again I should have substituted for G clamps as some of them were loosening off of their own accord. On the fingerboard at the 12 fret body join I placed an mdf caul spanning from the 10th fret right up to the sound hole and this was fixed both with a cam clamp over the 12th fret going under the heel cap, and also with a G clamp that reached into the soundhole and rested under another caul placed directly underneath the soundboard section underneath the fingerboard. I then made sure the fingerboard and the area of the neck to be glued onto were both free from any lumps or bumps or tears in the wood before gluing together with the hot animal glue.

## Restoring the finish along the breaks

Oct 2nd: After having left the glue to set for a good while, I firstly cleaned up the joints with a cloth lightly dipped in boiling water to take off all the excess animal glue. I then sanded around the joints with 240 grit paper to take away any glue or loose wood fibres. I used the scraper along the edges of the fingerboard that run along the body as these seemed quite rough. I mixed up some cellulose terracotta red paint alongside some vitapol

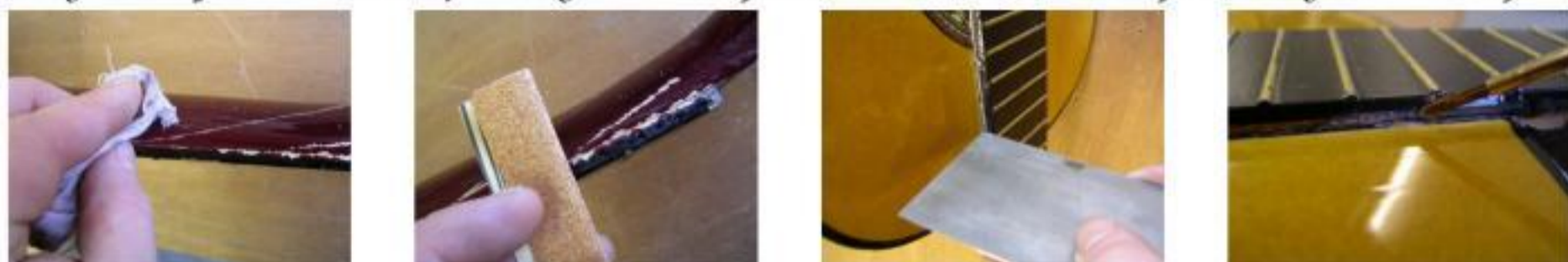

polish and also added some spirit red analine powder dye. The vitapol and the cellulose paint don't mix too well so when I applied the paint to the unfinished areas around the joins it went on very thin and see through and was not a good match at all. I tried to darken the colour of the mix by adding in a dark oak analine powder dye but by mistake added tons too much so the mix ended up black! Having done this I thought I could use it to paint in the fingerboard edge which was also showing through some of its original light wood where it had split from the neck. This worked quite well though I could see I would have to do that again later on. For the second



mix of the burgundy colour paint, I decided to skip out the Vitapol and just mixed the analine powder dye with the cellulose red. This worked really good for both colour and consistency though as I only mixed up about a table spoonful in a jam jar lid, it started to thicken really quick until it was standing in peaks when i took the brush out of the mix. In the end though this mistake proved useful as the paint became almost like putty and helped to fill in the quite deep cracks that developed in the very thick original finish of the neck. I dabbed it on more trying to fill in as many cracks as possible knowing I'd probably have to leave it to dry for a few days. It was already beginning to look better.



## Second day of restoring the finish



Oct 4th: Cleaned up joint initially with a bit of 400 wet and dry and soapy water but moved onto a scraper as the previous days paint was pretty thickly applied. The scraper worked quite well and cut away most of the thicker areas much better than the wet and dry had done. Once done could see there were still a lot of problem areas but it was at least 40% better than before. Mixed a new batch of cellulose paint as before but added in some cellulose thinner this time obviously to make the paint a bit easier to apply. This worked good. It also dried much

quicker and on the second cutting back with wet and dry I could see that the cracks in the finish were now beginning to get filled up with the paint.



At this point Bill suggested filling in the cracks with superglue the same as i did with the back dents on the guitar I made last year. When I applied the superglue it seemed fine at first but by the time I done all the cracks it seemed to have gradually made the dark red paint turn a brighter shade. Will leave it overnight for the glue to harden and see whether the colour has darkened down again.



## *Third day & fourth day - cleaning off superglue and retouching*

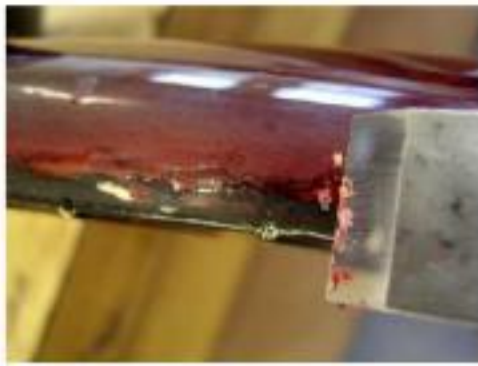

Oct 6th: Today I chiseled off very finely the superglued areas to try to bring the finish back to a level surface.

This was quite difficult as in some areas I chipped away back to the wood again where the paint must have been very thin but I continued on as knew I would have to repaint everything again anyway. Also the black fingerboard edge was a bit rough so I had to try to tidy this up more too and I decided while working at it that I will repaint the fingerboard edge black right at the end once I am satisfied with the main part of the neck.

After this I used a piece of 400 grit wet and dry to blend in the superglued areas and try to merge everything into one even surface. This worked quite well. Using exactly the same burgundy paint I had mixed up in a jar and sealed the previous day, I then began going over all the cracked areas of the finish for the third time. This time it was really beginning to look a whole lot better although I think I will have to do a fourth coat again the next day.



Oct 9th: fourth and fifth coats - beginning to lose a lot of the pittedness of the surface

Oct 11th: light sanding with wet 400 wet and dry then moved onto applying 70% vitapol french polish to the whole back of the neck with the rubber. This really made the difference. It was virtually dry before I could even put it back down but I left it for 30 mins to an hour and then applied a 2nd coat. After this the lightest sandpapering with lightly dampened 400 wet and dry. This process repeated twice more to make a total of 6 coats applied with the rubber in a day. Repair is now almost invisible as far as the surface goes though there is a slight darker area where the break was (see left).



## *Sanding back polish and painting fingerboard edge*



Oct 12th: With the burgundy area of the neck now looking pretty good I decided it was time to get the fingerboard edge back to a black ebony colour. For this I just used some black acrylic for speed as the job was as the neck on this guitar was not the best quality ~ think it was made of some lighter wood - possibly pine ~ and had been painted anyway to look like ebony (ebonised as they call it!).



I first very lightly sanded back the fingerboard edge where I had coated it in a layer of vitapol polish. This was mainly just to flatten out any bumpy areas. I Then put 2 strips of masking tape down the fingerboard edge to give me a nice clean edge to work to. Next I finely painted on 2 layers of thin black acrylic until happy that it was even. After this I took off the masking tape and went over the whole neck and fingerboard edge with three more coats of vitapol, this time thinned to about 50% polish to 50% meths.

After this I used some dampened 400 wet and dry and very lightly went over the whole neck and tried to tone down any last imperfections in the surface.

I then went on and used a rubber with 70% meths to 30% polish, with the rubber soaked in meths and blotted nearly dry. I went over the whole of the repaired areas with this using a faster motion to bring about a higher polished surface. I covered the area with the rubber several times and left to dry for a couple of hours. I repeated this process another twice and then left to dry for 2 days.



Once fully dry for a couple of days, I next used a clean duster with some burnishing cream to buff the restored surface so that it blended in as close as possible with the finish on all the surrounding areas of the rest of the guitar.



## *Fixing a loose back brace*

### *Tools & materials used:*

*240 grit sandpaper  
sanding blocks  
cam clamps  
2 mini grip clamps  
mdf clamping cauls  
3/4 inch firmer chisel  
cabinet scraper  
titebond glue*

## Assessing job, cleaning up back and braces before gluing



Oct 4th: For this job all the three braces had come loose when taking off the guitar back. They had all broken off in one piece but there was a lot of mess with with random glue and splinters here and there as well and also a section of the beech ply veneer had split off in the process. I decided to do an initial tidy up of all the components, firstly the back itself, which I clamped down to the bench before beginning. Using a 3/4 inch chisel I managed to take away all the excess glue where the braces had been attached. Finally I used a medium sized sanding block



and cleaned up the whole back (inside area only) to try to improve the look of it. I used a cabinet scraper along the edges of the back too to bring the surfaces back flat again. I left the end block section alone as it had not broken off clean. Realised that if I removed it then the guitar would not glue back together again properly. I then cleaned up the individual braces in the same way, removing badly applied glue and bringing them back to a cleaner condition for working with. Once this was done I clamped up the section of beech ply that had broken off using titebond and 2 clamping cauls roughly the size of the break with a glue resistant coating on the clamping caul surface facing the glue join. I held these in place with 2 mini grip clamps.

For the brace I used titebond and 4 cam clamps trying to make sure the cam clamps angled in from the side to avoid the brace gluing at an angle from the back.



## *Tidying up the shape and profile of the brace*



*Oct 9th: Once the brace was glued in place I decided to tidy it up as it had been pretty crudely made so I scalloped the ends of it using the 3/4 inch firmer chisel firstly.*

*When that was done both ends, I set about reshaping the top edge of the brace so that it was like an arched window. Firstly I drew a line down the centre of it and then, using the same chisel I began to take off material either side of the line trying to round the brace up towards a peak.*

*After I was happy with the shape I then used a small sanding block to further round the whole brace shape, finishing off by taking the sharpness off the top surface.*



# Rib Shatter Patch

## Tools & materials used:

bandsaw  
pencil  
3/4 inch firmer chisel  
cabinet scraper  
g clamp  
6 inch rule  
scalpel  
titebond glue  
1 inch gouge chisel  
half round rasp

## Preparing and gluing on a shatter patch for a broken guitar rib

Nov 6th: Using a fairly cheaply made classical guitar, I got Ross to do a karate chop to one of the guitars ribs to give me an example of a rib crack to repair. The wood being plywood didn't crack too well in the same way solid wood would. Nevertheless there was an obvious break in the rib which I was able to identify and work with. What I had to do first was to clean up the inside surface which was pretty 'caked' with pva white glue. To clean

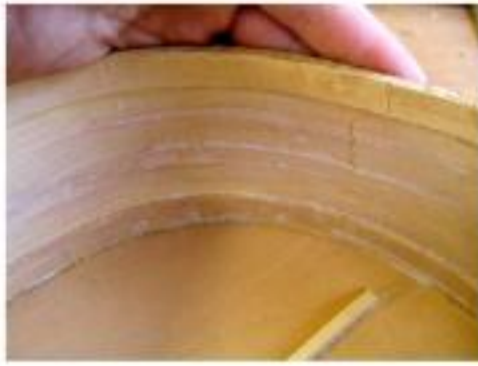

it up I had to use the 3/4 inch chisel, the cabinet scraper and finally some sandpaper to get all the surfaces prepared for gluing on a shatter patch. Once this was done I took a

block of wood with the grain running upwards and with the grain direction facing outwards from the rib, and placed it underneath and in alignment with where the crack was on the rib. Using the shape of this area as a guide to the shape the patch needs to be to perfectly hold the crack together, I then drew on two lines, the second line about 2mm away from the first. I

double sided two blocks on either side of the main block to give myself some distance



from the band saw blade when I make the cuts. The first cut I made with the band saw was to be the side which will be glued onto the rib so before I went any further I tried to round this face on a sanding block to get it to fit the area it need to be fitted to, as flushly as possible. When this was done I then made the second cut which is less important as this face can be cleaned up afterwards. When the patch was made I then did a test run using a g



clamp with everything set up as shown in photo above right. This method is great

as the remainder of wood that is left perfectly fits as a clamping caul to hold the whole repair together. Double checking that the shatter patch was fitting flush, I then titebonded it in place and clamped up the whole repair assembly.

## Thinning down glued patch and refinishing outside



Nov 8th and 9th: Firstly I unclamped everything and could see that the

shatter patch was still a little bit thick so I used a gouge chisel and then a half inch chisel to thin down the patch to about 2 - 3 mm, trying to make sure its thickness was consistent all the way down its length and width. When I got closer due to the awkwardness of keeping the guitar stable I then thought I'd use the half round rasp to remove more material while also rounding the shape a bit more than the chisel could do. Finally I double sided some sandpaper to the block the patch was cut from and used this to refine the curved face of the shatter patch further. I also at this point cleaned up around the patch a little more removing any beads of glue at sides etc.



With the patch now complete, I had thought I perhaps better now tackle the finish on the outside of the rib crack to restore it and conceal any trace of the

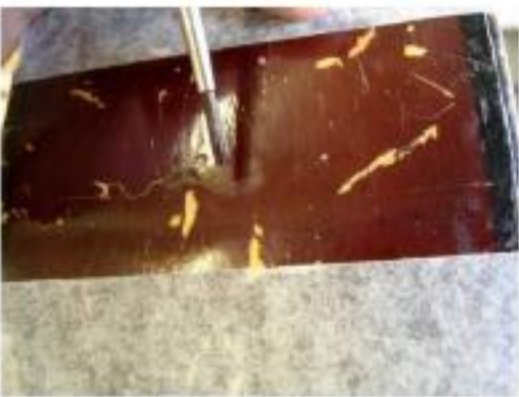

crack. I mixed up a burgundy colour again from the cellulose mix made for the broken headstock/neck break repair and used this also some dents

to patch in the crack line and around about it. I did this twice to build up the surface again using the puttying technique earlier described when the paint mix has dried out so much that is almost standing in peaks when applied. This seemed to blend in quite well so when dry an hour or so later I cleaned off the area with some fine wet and dry sandpaper.

At this point I decided that it was sorta pointless attempting to refinish this repair as the rest of the rib (and guitar) were covered in scratches and dents so felt that it would just be a repetition of the headstock/neck break repair done already which I feel I made a better job of due to that particular guitar being less damaged already.

# Resetting neck joint & full re-fret

## Tools & materials used:

feeler gauges  
hand drill  
3/4 inch firmer chisel  
sanding blocks  
g clamps  
mdf + cork for clamping cauls  
double sided tape  
bench vice  
try square  
medium rasp  
scalpel  
junior hacksaw  
1 metre straight edge  
6 inch rule  
cabinet scraper  
needle file for rounding edges  
angle block for stoning fret edges  
5 1/2 plane  
gent saw for re-cutting slots  
engineers 2 inch square  
permanent marker  
fretwire cutters / pincers  
hammer  
6 inch flat file  
marine ply soundboard protector  
superglue  
large pressure cooker pot  
steam condenser pot  
rubber or plastic tubing  
glass needle  
a double electric hob  
hot animal glue  
an aluminum pot  
a jam jar  
a small flat brush

## Steaming joint apart

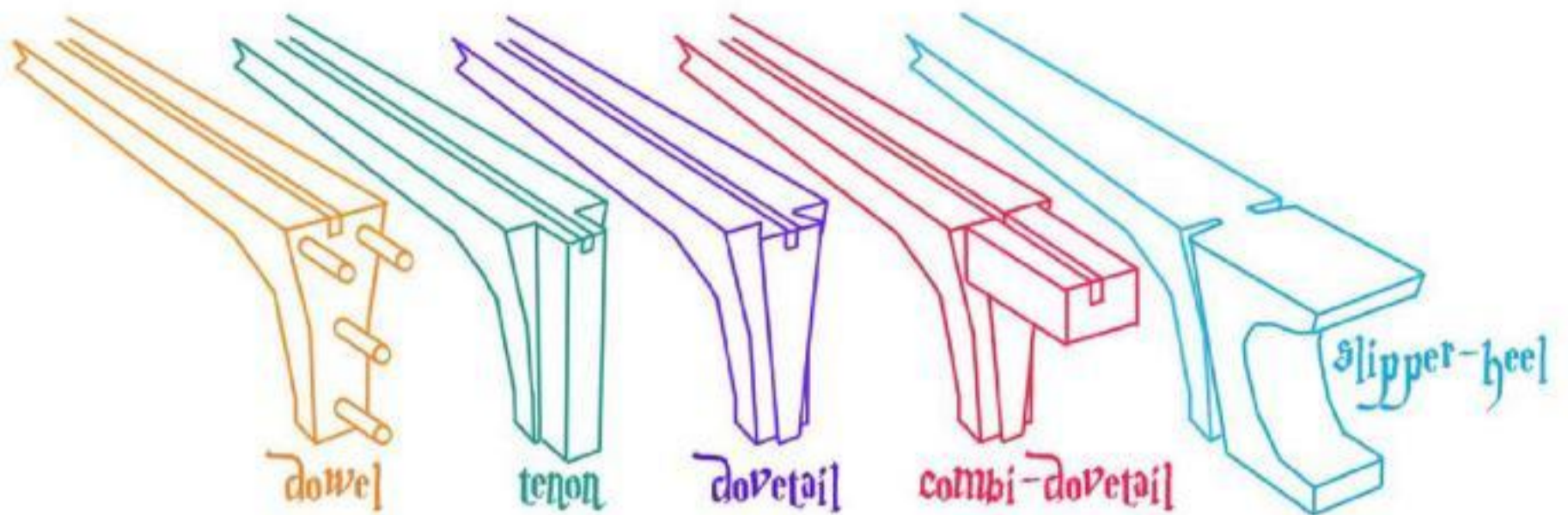

Oct 9th: This neck reset (alteration of the neck angle in relation to the guitar body) was just an exercise aimed at highlighting some of the processes involved. A neck reset might be needed on a guitar if the string height (action) becomes too high or low and so difficult to play. Initially I began scoring around the heel with a scalpel where it joins the body to cleanly break the laquered finish in order to minimise the refinishing work at the end of the job. After a discussion of the different types of neck join possible (above), I assumed that this guitar might be a dovetail joint. Although it was a classical guitar, I could see it was not a slipper heel which is often the case in factory made classics. I initially removed the 12th fret (mistake) instead of the 13th which is where the end of the dovetail would be situated. I remembered it would almost always be the fret after the body join and then removed the 13th fret as well. I drilled 2 holes about 15mm in from with the edge at the 13th fret position with a 1/4 inch drill bit to a depth of about 60mm. I angled these holes (see below right) to follow the shape of the dovetail. These holes were drilled in an attempt to give access to the glued dovetail while avoiding the truss rod which is positioned centrally underneath the fingerboard. Once this was done I then attempted to 'steam' the glue joint apart using the pressure cooker and condenser as illustrated on the next page. This did not seem to work and so I had another look inside the guitar and felt about with my fingers to judge the depth of the block away from the rib. It was less than I thought at about 30mm so from this I assumed that it was in fact a dowel joint and not a dovetail.





## Explanation of how to get steam into the heel joint

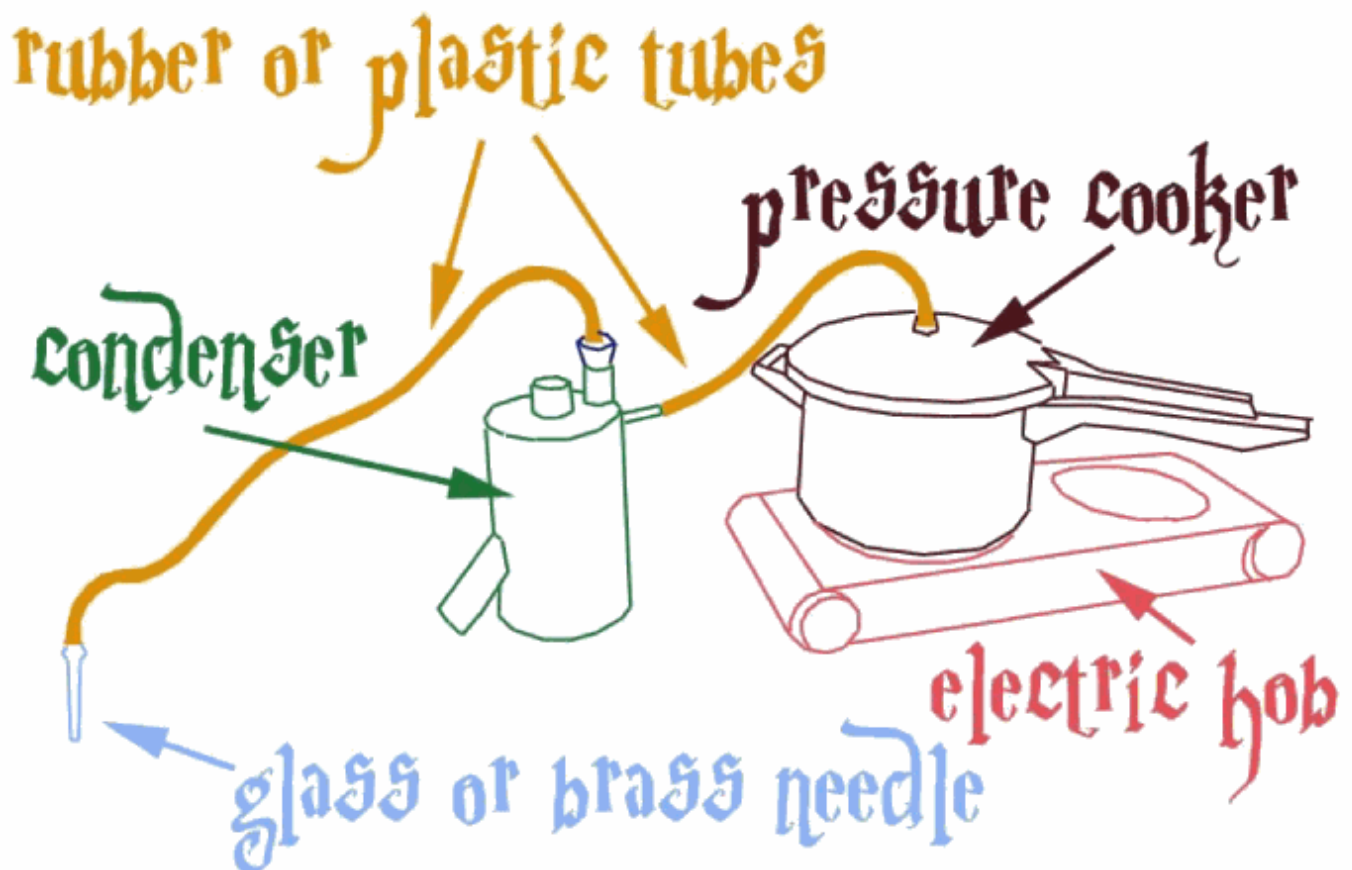

Important with this setup was to make sure the pressure cooker lid was on firmly and to try to keep track of time that it was not allowed to boil dry. Also the jet of steam is pretty dangerous as regards burns so a lot of caution is required using this procedure. An addition to this setup would have been to put the condenser in a pot of cold water as this would have made the steam condense quicker.

\* There are obvious dangers involved in this procedure so please only attempt it if you are 100% confident of the risks that are involved.

## Discovering it was a dowel joint



Oct 9th: This mistake meant that I now had to drill on the 12 fret just one hole (luckily I had already taken the 12th fret off!) in the centre of the fret position and used this as a way of getting a jet of steam into the dowel joint. Interestingly at this point I must have made the assumption that because it was a dowel joint it would not have a truss rod and only drilled one hole in the centre as mentioned. Not sure why I decided this but the drill went through fine to a depth again of about 60mm.

I was then able to use the steamer to get the steam needle into the neck body join area. Steaming it took a good while and I would steam for 5 minutes then hold the guitar face down on a padded stool and rock the neck back and forth while holding my other hand at the end of the back on the block. Gradually it seemed to be easing away and then finally something snapped! I think I probably forced the neck a bit but thankfully it split quite cleanly where it appeared to have been split before, although the dowels seemed still firmly locked. After a bit of manouvering about it seemed as though the fingerboard had already been cut down the 12th fret so I took a junior hacksaw and cut through cleanly to avoid any splintering. Ideally the whole fingerboard would have come away intact and still attached to the neck. In this case it had already been cut through. Cutting it through probably will mean that when the neck angle is changed, the fingerboard will no longer be even and so it will be likely need to be planed down again a little. This means re-fretting the entire fingerboard so more work :o(

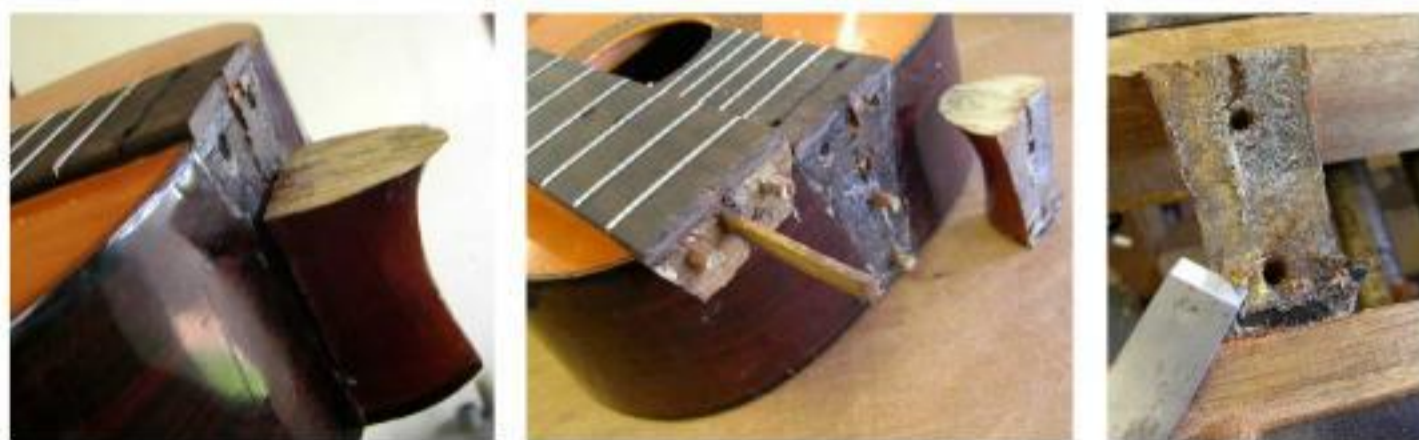

After this the top section came away though there was a rusty misaligned truss rod in there that took a while to loosen. Next I steamed what was left a bit more and it finally came free. The first thing I did was to clean up the joint areas using a little hot water and also a 3/4 inch chisel on the face of the joint area on the heel.

After this the top section came away though there was a rusty misaligned truss rod in there that took a while to loosen. Next I steamed what was left a bit more and it finally

## Gluing broken heel to neck & cleaning up body join



Oct 9th: After cleaning off the excess glue from the dismantled parts I then had to think up a way of gluing on the broken part of the guitar heel back in place. For this I made an mdf clamping caul with cork blocks double sided on, to fit inbetween the frets so as not to press the frets in any further. I placed a block on the heel itself and got ready a G clamp for this part of the job. To ensure that the heel was being pulled down as it tapered down towards the neck itself I used a phone directory (covered in masking tape) as a clamping caul and prepared 2 more G clamps for securing this area in place. When I had tried it out fully, I went ahead and glued the heel together using hot animal glue.

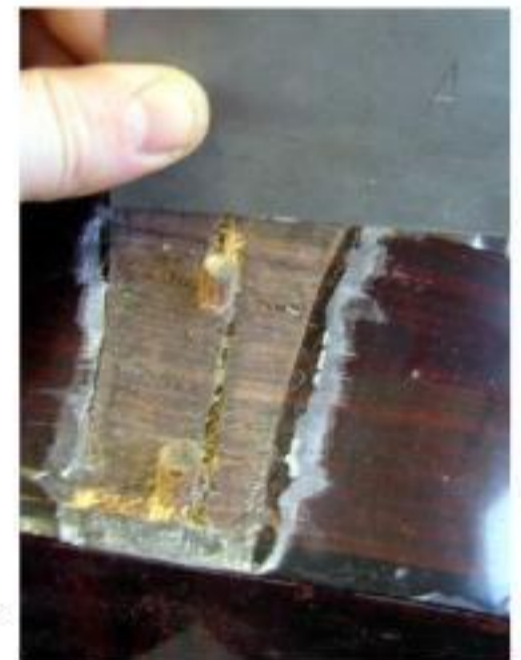

Leaving the heel gluing up I then went on to do a bit more cleaning up of the area on the body where the heel will be glued back onto. I mainly used the 3/4 inch chisel to try to remove any old glue and to try to level off the surface. The laquered finish had also cracked quite a bit in the process of separating so I had to try to scrape the cracks level with the cabinet scraper then some 400 wet and dry sandpaper. The dowels also needed a little tidying up too.



## Tilting the neck angle back



Oct 11th: Just realised I had made a big mistake in not measuring and recording the neck angle and string action prior to beginning work on this instrument. Missed this out and went straight onto taking neck off.

Because I had not taken any material from either face of the joint, I took some measurements at this point, taking note of where a straight edge was hitting the bridge with the straight edge fully rested on the fingerboards surface. In order to raise the string height by 1mm I would have to tip the neck back the same amount.

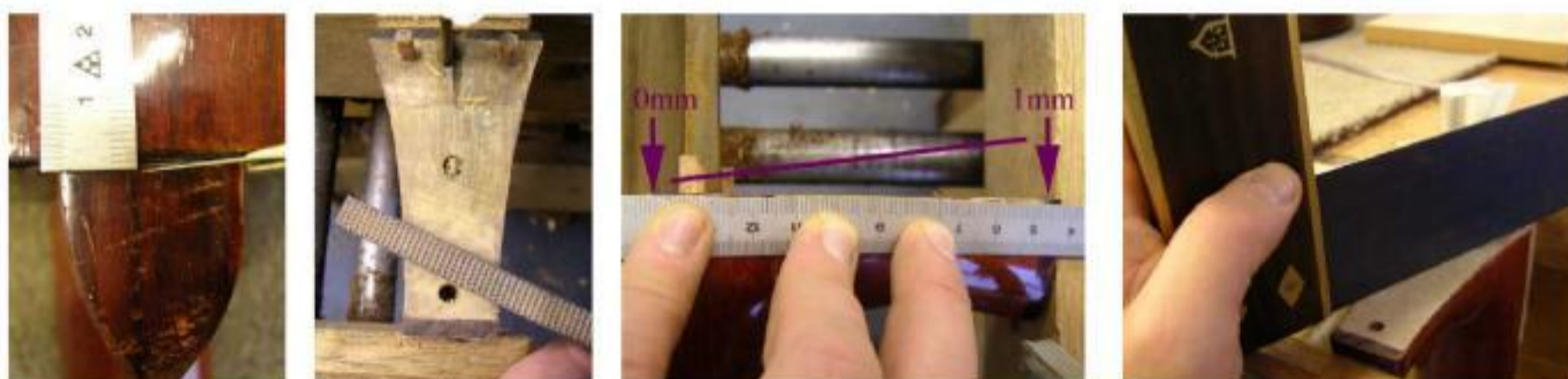

To do this it's important not to alter the length of the neck top face where the fingerboard is. Any change to that length would mean that the frets after the body join will be out of position and this would mean removing these frets, filling up the slots with wood, recutting slots and finally hammering in new fret wire. Also because the scale length would be 1mm or 2mm out depending, the saddle position would have to be changed, possibly by re-routing a thicker saddle or filling in the saddle slot and re-routing it from scratch. Because of this it is important to only take off material (or add on?) from the bottom edge of the heel joint and taper this dimension gradually up towards zero at where the heel meets the fingerboard. This allows enough material to be removed to reset the neck. First of all measured 1mm to take off heel and then continues this line up the sides on a slight tilt which meant there was zero to be taken off at the top.

Marked this in with a scalpel. Fixed the neck in the bench vice using the cork fret protecting mdf caul from earlier to keep frets from being crushed in vice. I then set about chiselling at it but as it is end grain it is really difficult to cut with a chisel and so Bill suggest a medium rasp. This helped a lot and I made faster progress after this. I levelled it off with the rasp using my scalpel lines as a guide and double checked in a few directions with the try square to see if it was all looking flat.

## Trying to get the heel fully flush with body



I also checked the neck angle again using the straight edge. Sadly it seemed I had brought the level up by 2mm on the bridge edge, although I am certain I only took 1mm off the face of the heel. Thinking about it, 1mm

taken off the base of the heel would raise the fingerboard 1mm off the soundboard at a point equivalent with the length of the heel. The pivot point is the body join so pulling the heel back half that distance (0.5mm) should mean you are raising the angle 1mm at a point twice the heel length along etc. So to tilt the neck back in order to get an action that's 1mm higher at the bridge, it would only be about 1/4 of a mm or probably less that needs to be taken off the bottom end of the heel joining face. (see illustration on next page)



Having now taken too much off I guessed I could possibly fix this situation when I re-plane the fingerboard down with the possibility of lowering the saddle. I then decided to start re-fitting the neck and joined it back on to see how it looked. The change in the angle that the heel meets the body means that the dowels holes on the heel are just slightly off the correct right angle for the connecting dowels so I had to chisel a little off the top sides of the dowels to bring the neck into fitting up flush against the body.

Once the neck was as flush as possible I used the feeler gauges to see how much of a gap there was between the heel join and the body. It was quite a lot at about 1mm in a couple of places. Tried a bit to remedy this by rasping off some more material where it seemed to have been sitting flush. This helped slightly. Bill said to check the area on the guitar body to see if it that was flat too and when I checked it with a small straight edge could see it had a big curve on it it.

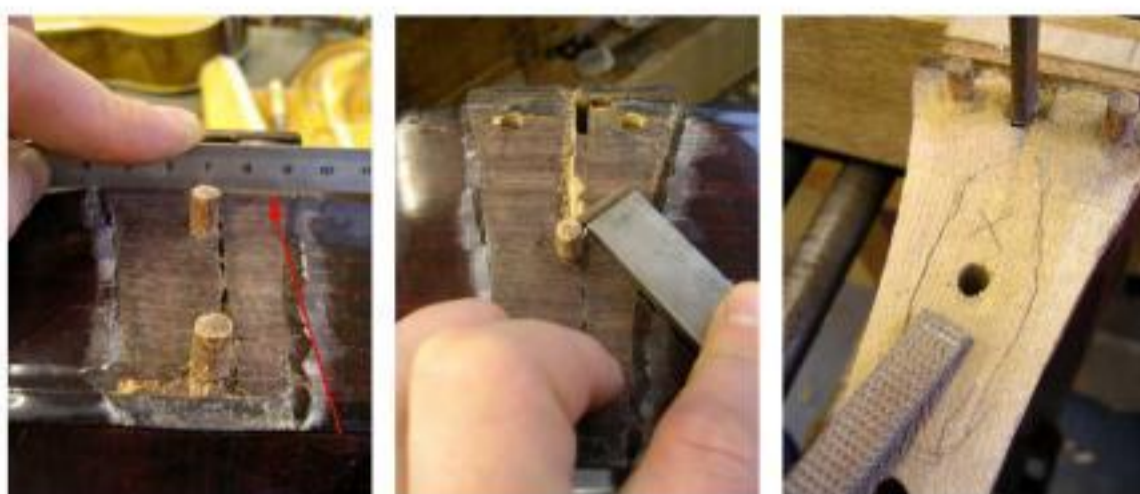

At this point using a 3/4 inch chisel I attempted to carefully flatten this area on the body checking with the small 6 inch rule for flatness. I then kept trying it inbetween times and also attempted to take a little out of the middle of the heel face to make it ever so slightly concave to try to bring the heels edges into flush

fitting with the body.

Worked on this for quite a while taking my time until I eventually got the two fitting as solidly as possible.

*One mm off heel and effect at same distance along fingerboard*

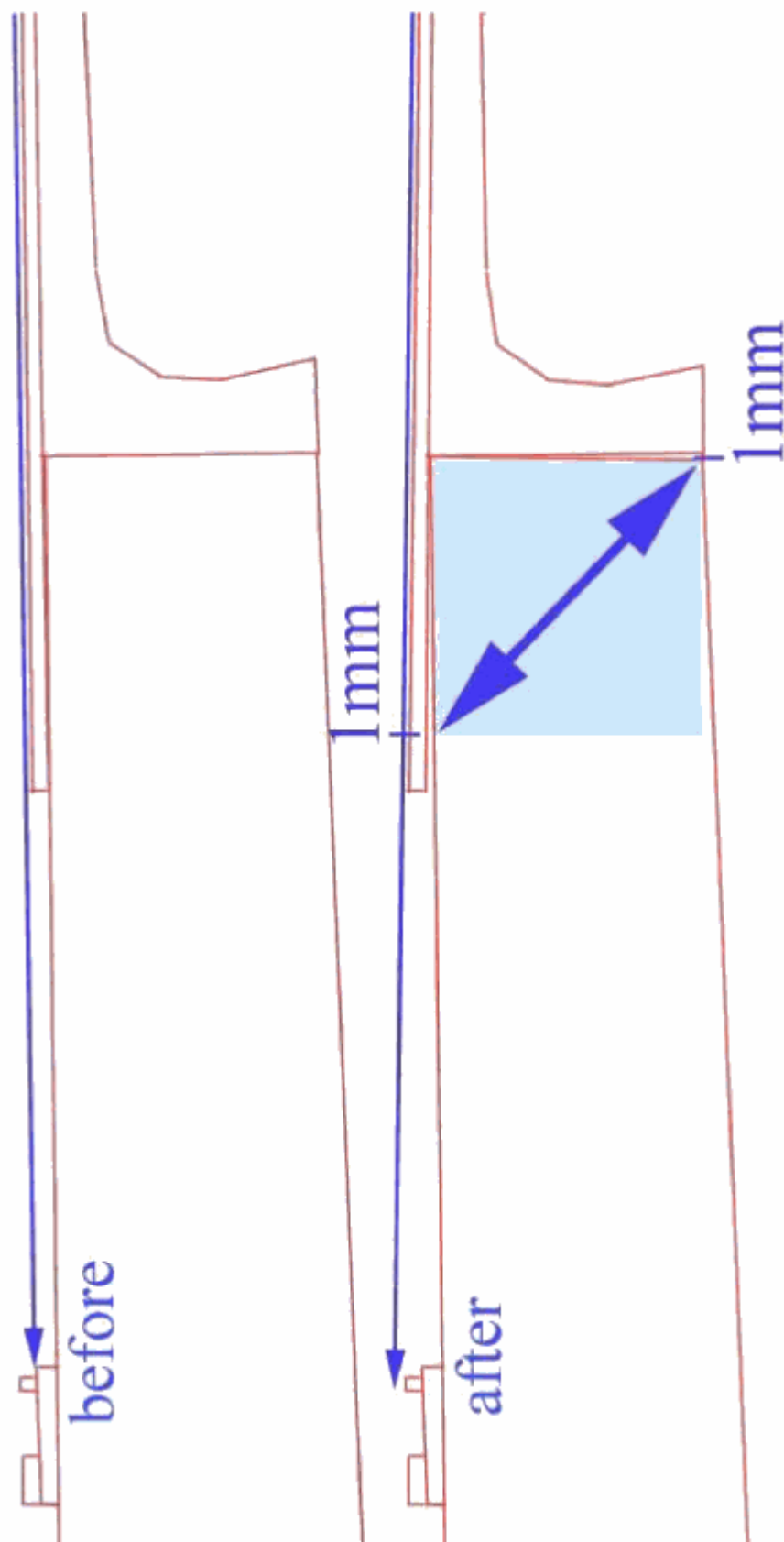

Taking the neck angle back by a whole 1mm at the heel cap means the fingerboard will already be 1mm higher at a position square to the heel cap so by the time this line is followed down towards the saddle the difference to the string height (action) could be as much 2 or even 3mm.

## *Final adjustments before regluing neck to body*



Oct 23rd: Still seemed to be having a lot of trouble trying to get the heel to fit the body. Made a little sanding block to try to focus on the body itself to try to flatten up the top end which seemed to be where it was fitting close. Finally made a breakthrough with this by working out it was not fitting at the back of the fingerboard edge where I had changed the angle. As soon as I started to very finely chisel away this area the whole heel began to become a lot tighter and the feeler gauges here were really helpful in judging this.

At this point I now had another look at the fingerboard onto bridge/saddle angle. Because I have went a little too far with the neck angle as described on previous page, I think I will have to plane down the fingerboard and then refret it as the section of fingerboard on the body is way off the neck fingerboard angle.

Once nearly there I went ahead and done a dry run with the string and used my burnisher to tighten (tournequet fashion) the neck onto the body. I then done a little more chiselling and filing until it seemed a feeler gauge of 0.15mm thick was not fitting in anywhere around the heel, then done one more dry run with the string to check this.

Because of the time process of fitting the heel and then tying up the whole setup with string, I decided to use the titebond as this would give me strength but also allow me to take enough time to glue the whole setup carefully. The animal glue would have been too much of a rush and may have meant the neck not being set at the correct side to side angle.



## *Final neck side to side check then gluing*

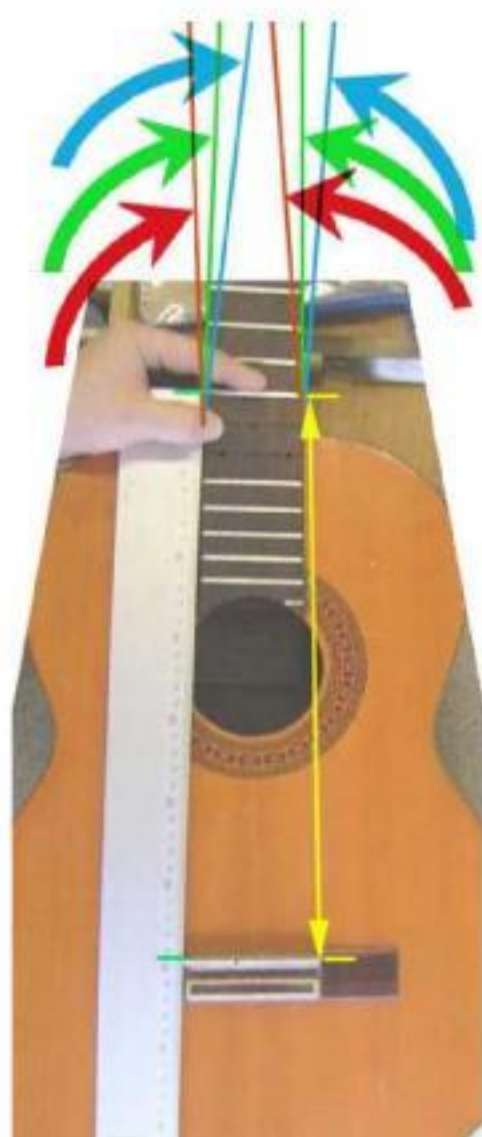

Oct 25th: Before gluing I had to also check what the side to side angle would be on the glued up instrument which could cause intonation problems that would not be easily resolvable. To do this I measured from the 11th fret edge to the bridge saddle edge and compared this with the opposite side to make sure the measurement matched up. I should have also perhaps measured from the nut to the saddle as well as a way of double checking (do this next time).

Once happy that the neck angle was as best as I could manage, I arranged the string and applied titebond to the neck and evenly spread it over the heel face and over the dowels and into the dowel holes. After this I put the two halves together and pushed firmly together then gradually tightened up the string until I could see all the glue had squeezed out of the joint. The glue did squeeze out both sides but more so on one side than the other. Tightened up the string even more after this and finally cleaned off any excess glue before leaving for a couple of days to dry.



## Removing rest of frets & re-planing fingerboard

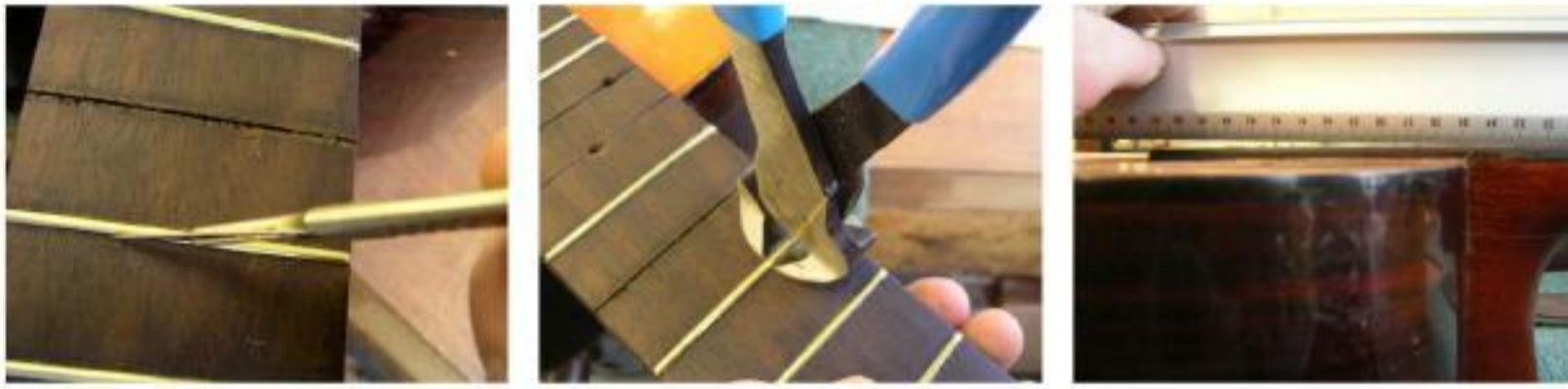

Nov 1st:  
Next I had  
to remove  
all the frets  
so before I  
did this I  
scalpeled

down both sides of each fret to prevent the possibility of any break-out in the wood. I then pulled the frets out with the fret cutting pliers. When this was done I used a straight edge to assess how much had to be planed off the fingerboard to get it back to being level again. It was quite a lot due to me taking too much off the heel. I used a sharp number 6 plane to take most of the material off (it was rosewood so it was pretty tough on the plane and I had to resharpen at least once more during the course of the job. I also used the block plane a bit inbetween to try to remove the worst of the bumpy area around the neck/body join.

When trying to get it flat I thought of using a chalked block the size of the fingerboard to assess where it was higher and tried this a few times along the way to see if it would work. Gradually I got it 90% flat but nearer the soundhole end it still was a little bit tapering down but not too bad.



To put in the string relief area around the 5th fret where the strings sit very close to the frets I had to make a little clamping caul to hold down the headstock firm

to the bench, to allow me to be able to push and hold down the lower bout end while at the same time still be able to plane the area around the fifth fret where the fingerboard arches slightly due to the forced bending of the neck backwards against the neck rest which is placed directly under the fifth fret! The amount to remove is only slight - a sheet of A4 paper's thickness so it didn't take long to do. It was more the process of working out how to fix the headstock end down to the bench firmly that took the time here.

## Re-cutting the fret slots



*Because I had planed down the fingerboard, I had to recut (with a gent saw) the fret slots to 2mm deep to accomodate the new fretwire depth of about 1.5mm. This was fairly quick to do and I made sure to used a piece of thin ply when cutting the slots over the body.*

## Re-fretting and fixing gap under fingerboard



Next was re-fretting which was pretty not too bad - hammering in a big length and then cutting with the fret cutters. Up to the 11th fret was fine. At this point I then decided to deal with

the end fingerboard fret which is split due to the curve of the soundhole. For these 2 pieces I used the cutters and cut the fret from above at roughly the same angle. Figured this would save time later when filing the sharp edges round. Once this was done went back to the 12th and 13th fret positions there were 3 drill holes from steaming the joint apart. Decided better to plug them up with some rosewood dowels as thought maybe it would maybe add a abit of strength for holding the frets in place. Used the piece of steel with holes in it and hammered some pieces of rosewood through a sequence of gradually decreasing in size holes until I ended up with enough to plug all 3 drill holes in the fingerboard. I superglued these dowels in place and left to set.

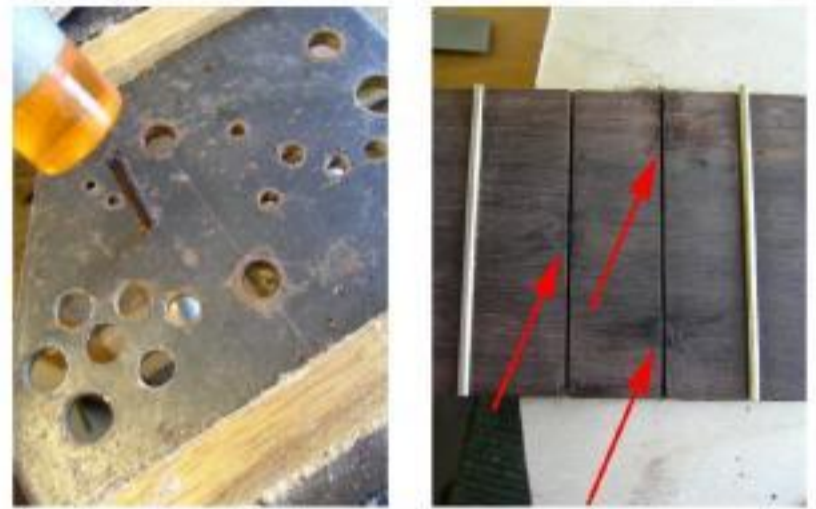

When the glue was dry I then cleaned up the area lightly with a stanley blade edge used as a scraper and then fretted this area supergluing the frets in place. I also superglued all the other frets after the 13th including the 2



split frets at the end as it seemed to be that each hammer blow was displacing the frets around about. Visually checking down the neck to be sure of a good alignment I then proceeded to use the stoning block with the slot for the fret file to smooth off all the rough fret edges on both sides, followed by a final smoothing

of the corners. At this point, a bit late in the day I noticed a gap under the fingerboard! Having already fretted the instrument I figured I'd be as well to just try to put a supporting shim of rosewood underneath to fill up the gap as best as I could. I checked how deep the gap went in with the feeler gauge and it only seemed to about 10 mm in so I made up a couple of thin wedges of rosewood and thinned them to the correct size and once correct, glued them in place with titebond.



## *Another way to fix a loose fret*



*Another way to fix a loose fret in place is to simply 'distress' the tang of the wire with a hammer that has had the thin end ground across the length of its face into a point. By lightly tapping the hammer on the fret tang small bumps are created which will help wedge the fret firmly in place without the need for superglue.*

## Re-finishing cracked lacquer around neck join and fingerboard edge

Nov 8th & 9th: With the guitar neck now glued back on and the fingerboard flattened and re-fretted I felt now it was time to try to repair the damage to the guitars lacquer finish around the heel area but also along the fingerboard edge. Firstly I cleaned up the area around the heel trying to get rid of any residue of glue but also any rough looking pieces of the guitar's lacquer where it had cracked during process of removing the neck. I used the cabinet scraper and also some medium and fine grade sandpaper to try to smooth over these areas. Once this was done I mixed up some cellulose based paint, trying to mimic the colour of the heel. I made a mix that seemed to be a good match for the heel which I applied to all areas where the natural wood colour had become exposed. I went round this twice trying to let the paint get tacky enough to work more like a filler than liquid paint. This



worked quite well and seemed like it was a spot on match colour-wise. Even when I sanded and scraped the paint back the next day it still appeared to have been a good match but when I gave it an initial coat of vitapol french polish, the red colour of paint I had used showed up much lighter than the rest of the heel! So having left this mistake over the weekend to dry I will have to spend the next day re-mixing the paint to get a better match up. Feel though it would be worth doing on this guitar just to see how invisible I can make the end result.



Nov 13th: Today mixed up a better match of paint by adding some powdered spirit yellow to the cellulose red colour and this seemed to really match quite well so I applied a couple of layers around the cracked areas of lacquer and left to dry for 2 hours. I then went back and wet and dry sanded it with some water and cleaned off all the powdered yellow which seemed to separate again from the colour when sanded. Next I took the rubber and some vitapol and applied all around the areas concerned. The yellow powder dust though seems to have got into all the cracks on the body so I will have to now sand these bits back to a fresh surface and reapply more vitapol. The heel break though looks good though perhaps solid paint on a see through coloured finish is not a good idea as the wood grain doesn't show through the touched up bits. Still more to be done.

## Final touches to finish



Finally I realised I had forgot to fill in the fret slots with some superglue and veneers to match the rosewood on the fingerboard edge so did this and when dry cut away all the excess with the scalpel, then finished off with a sanding block.

Lightly sanded back the area which had become yellowed with the spirit yellow powder dye I HAD MIXED INTO THE CELLULOSE RED! This seemed to mostly sand away and I used a dry brush to try to remove most of the excess from the cracked areas in the laquer around the heel.



When this was all done I then used the rubber and some vitapol polish and went over these areas and the rest of the heel and the cleaned up the fingerboard edge. The heel itself with the painted in red area actually was beginning to look quite good now and almost invisible. Noticed the next day the colour had darkened a bit with drying which made it blend a bit better. The areas on the body at the edge where the heel joins however don't look so good. Although the yellow staining is mostly gone now, the polish doesn't seem to be merging into the original laquer finish too well and the cracked edges as well as some of the whitening from sanding seem to still be showing through. Think that this has shown me that it's important to assess what the original finish is made from and try to use 'like for like', especially in a larger scale repair such as this.



In the end it looked not too bad. With a bit more time I could have perhaps tried sanding back the whole surface around the heel join and tried instead to use a laquer like the original to see if this blended in the edges better.

## Stoning and profiling of frets

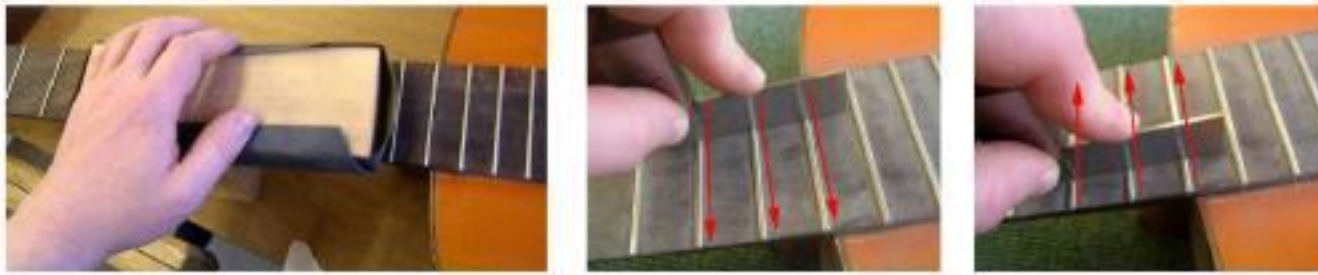

Nov 22nd: Initially used some 400 wet and dry sandpaper on the stoning block to bring the frets level

with one another. To make sure they were level I used the 2 inch engineers square to check 3 frets at a time for indication of levelness. This process was repeated all along the width and length of the fretted fingerboard. What I was checking for was any kind of rocking back and forth of the square which indicated unevenness. When any unevenness was found I tried to concentrate on these areas with the stoning block and sandpaper.

When this was done I had to first grind 3 blind edges on my triangular file using the circular grinder. This is to avoid scratching the fingerboard when profiling the frets with the file. This



took a wee while to get right. The grinder flattened the edges roughly then I moved on to a sanding block with 80 grit sandpaper held in the bench vice. I tried to even out any roughness from the grinder. This worked well and then went on to the water stone to smooth and round off the flats as the file will be used slightly off the flat as shown below.

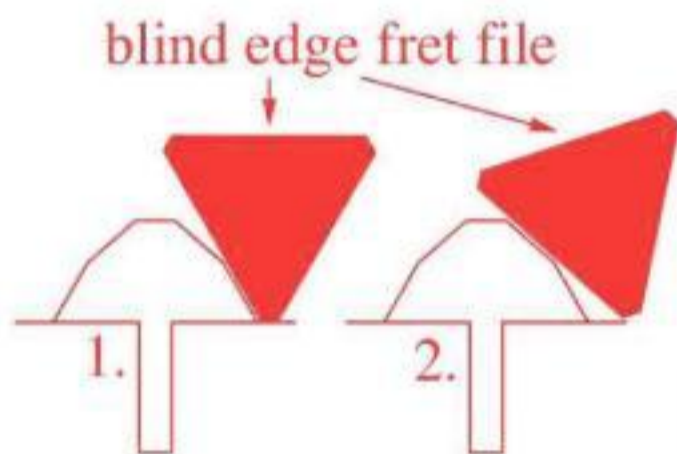

Next I used a felt marker to colour the frets and this will help me to see when I have reached the 0.5mm wide flat on the top of each fret. I used the file on each fret as shown above to give each fret an almost 50p coin shaped profile, until there was only the required width of flat showing on each fret top.

## Burnishing frets and finishing fretting job



Nov 22nd, 23rd & 24th: At this point I used the fret burnisher with some 400 wet and dry to round off the rough filed angled profile of each fret. This was followed by lightly rubbing each fret with some steel wool to bring them back to a nice shiny appearance. Once this was done I then had to use the stanley knife blades as scrapers to scrape the fingerboard inbetween each

fret using a side to side motion to remove any marks and scratches. Finally I used some lemon oil to seal the fingerboard and darken it down a little bit. This guitar had no nut and the saddle was broken so I now needed to make these from scratch. I made the nut by measuring against the guitar and cutting roughly to size on the band saw. After this I sanded what will be the bottom face that fits down onto the neck. I sanded the face on a sanding block in the bench vice. Next I sanded one edge which will be the edge that rests against the fingerboard.

To put the curve in I held the nut in a small clamp on engineers vice and initially planed a large chamfer along one edge. To round it off nicely I used a sanding block to run along it while still in the engineers vice. To make the saddle I made a little jig using 2 layers of marine ply with a hole the size of the nut blank cut out from each. I then glued and screwed these to



a block of plyboard and used this to hold the saddle face down onto a sanding block. This made the process of thinning the saddle to the correct thickness a lot quicker. Next I was to put a rounded chamfer on to the saddle top edge as this will prevent the string being broken when stretched over it. I cut down the saddle height by running a straight edge along the length of the guitar from the nut to where I thought the saddle should be and I made it just 2mm bigger than this to give myself something to sand down towards the correct height once I put

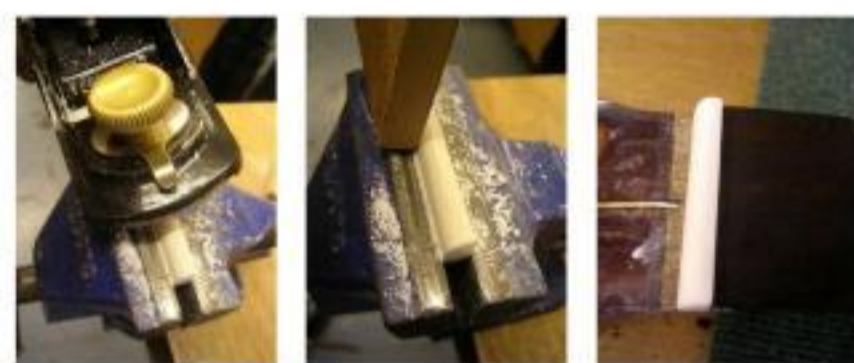

the strings on and assess the action. After this I decided to check on the string length as I knew I had taken too much material off at the 12th fret body join perhaps 1 to 1.5mm so did a bit of measuring and the 12th fret seemed to be at 329.3mm. This guitar must have been a 660mm scale length but when I measured back to the saddle the 660mm itself seemed to be beyond the bridge position so this would

mean that the 662mm with compensation would be further back still. At this point Paul just said to go on and fit the strings as this part of this discovery would really mean altering the saddle position and even possibly removing the bridge itself. Even with the saddle position wrong the guitar could still be strung up and assessed for the refret repair.

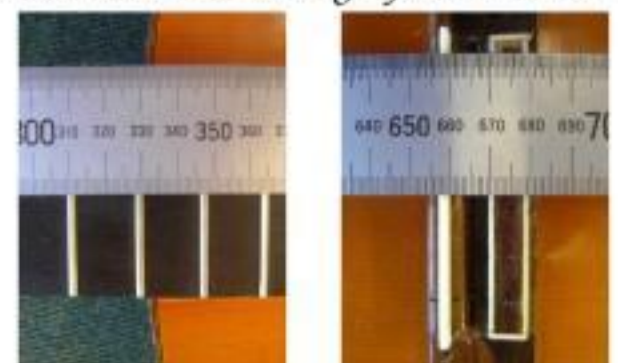



## Shaping and fitting new nut and mistake with saddle height

Nov 24th: With the nut shaped it was now time to fit the strings so I put them on and tightened them just enough for them to sit over the nut but still with plenty of movement side to side. I opted for about 3 to 4mm either side of the outside strings leaving me with 46mm for the 6 strings. The spacing was to be 9.2mm between



each string so I then drew these measurements on and using the pointed needle file I started filing temporary notches just deep enough to hold the string in place. When all 6 of these were done I was then able to tighten the strings up to full tension and assess the string height or "action". Looking at the action at the nut I was then able to make the notches a bit deeper gradually using the pointed needle file until I was happy that there was about 0.7mm between the top edge of the 1st fret and the underside of

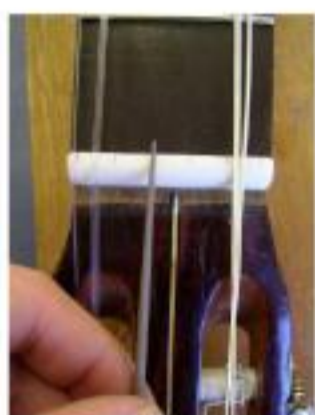
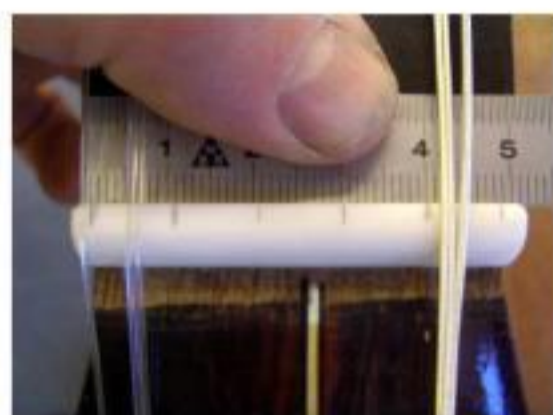

each string, when fretted on the 2nd or 3rd? fret. Happy with the string heights I then decided to try out something I saw in a book on a guitar by Antonio de Torres. On one guitar he had made further large notches (scallops?)

inbetween each string slot so using a round rasp I filed away some scallops mainly just as a tester to see if it worked. I



cleaned up each of these with some sandpaper round a small dowel. The result is not quite exact to Torres so will have to go back and study the image again to get it a bit better. Didn't want to go too near the string slot in case this affected the strength of the notch.



With the nut done I then had to attend to the saddle which was I thought a bit high at the 12th fret on both bass and treble side. I tried to make it a bit lower at the treble side once and tried it and it seemed still to high. I did this once more and must have taken off too much. After this the strings were buzzing like crazy. The guitar played fine before I altered the nut and saddle so need to now test the saddle height by propping it up with 2 maple veneers underneath to see if this improves the sound. Unfortunately when I started this today the machine heads started playing up so will have to find a better set of them on monday and fit them before going any further.

*Done!*



*Fitted another set of machine heads today though they didn't fit the best to be honest. Also brought in another nut I made last year for my own classical to test whether I had lowered the nut I made last week too much. When I put this nut on the guitar in combination with two 0.6mm veneer shims under the saddle it sounded a bit better again. There were still a few buzzes here and there and think perhaps I could have improved these by just making a new nut and saddle altogether and being a bit more careful with bringing the string height down. Also I think I was working blindly last week in the sense that I should probably have gotten last year's classical logbook out before even making the nut and saddle and this way I might not have taken the action down so low to start with. Don't think I made a fantastic job of this guitar but learned tons in the process.*















andrew allan ~ annie stand ~ 2005 / 2006

be yourself no matter what they say

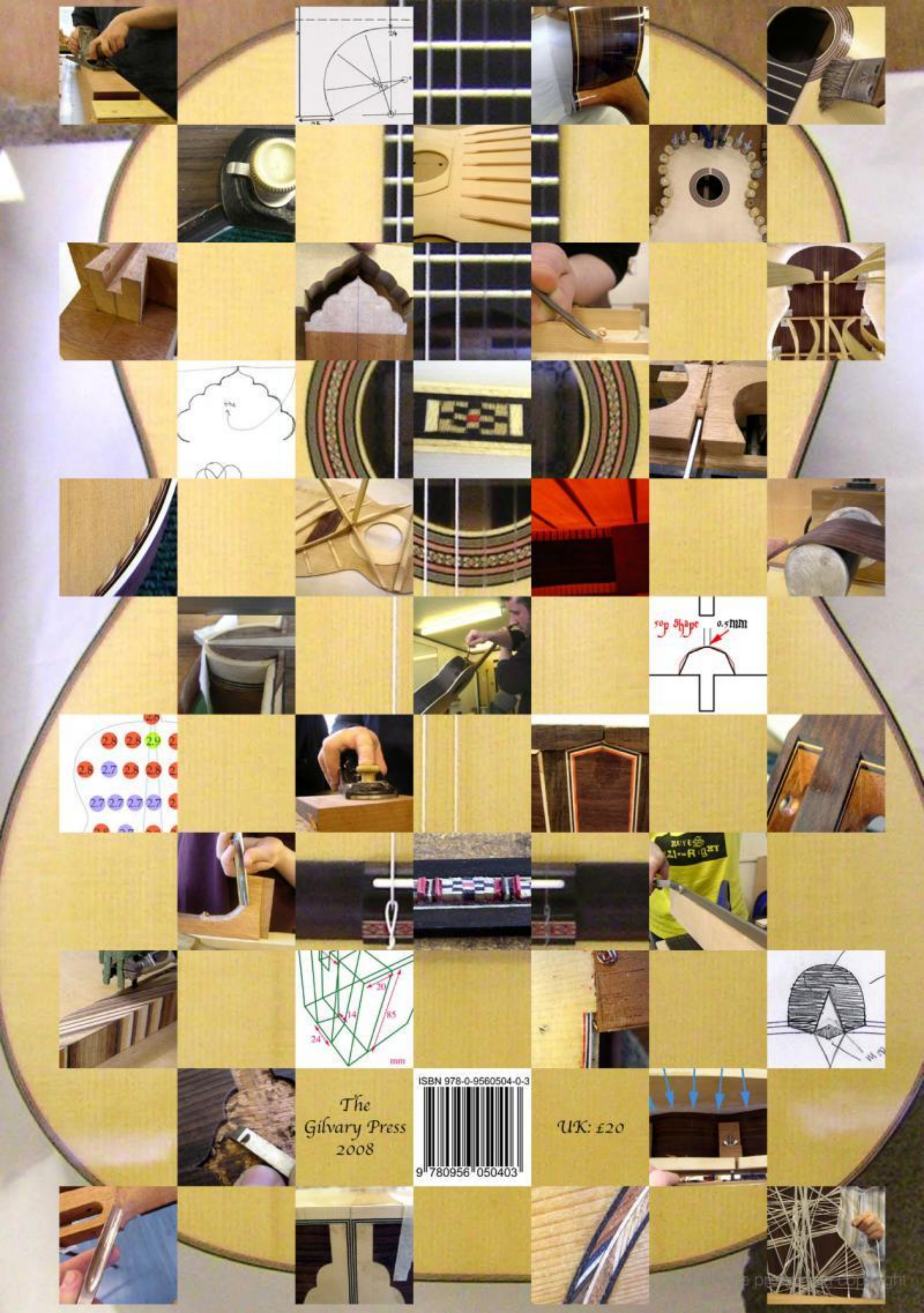

The  
Gilvary Press  
2008

ISBN 978-0-9560504-0-3

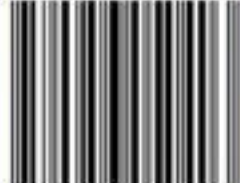

9 780956 050403

UK: £20

