

# BIRDS

## of North America

Realistic 3-D Scrollsaw Art



Wildlife  Series™

30 Full-Size Scenic Masterpieces

Rick & Karen Longabaugh

**Left Hills**

Stock: 1/16" - 1/8"

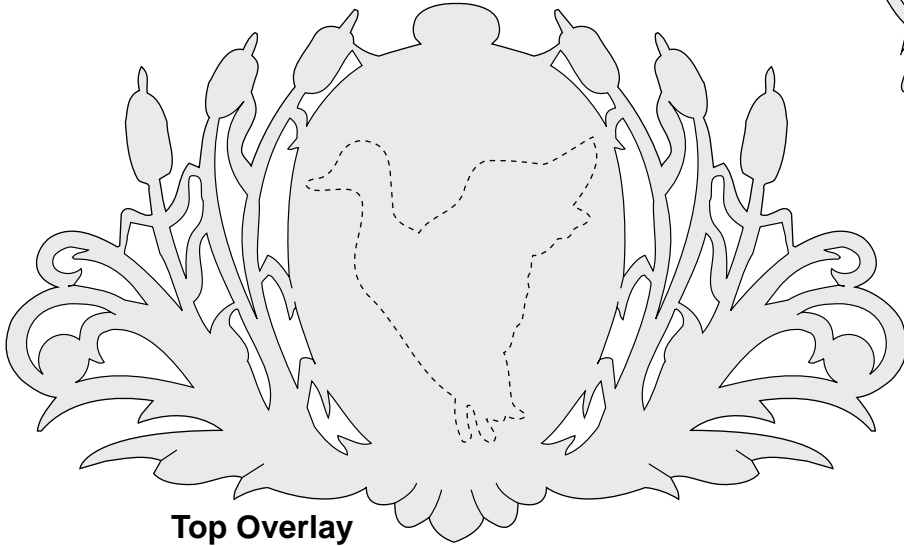
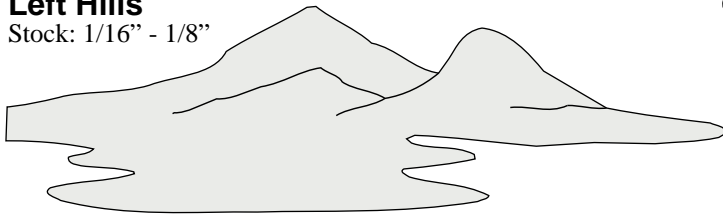

**Top Overlay**

Stock: 1/16" - 1/8"

Dashed line indicates placement of Bird Overlay.

**Left Bird**

Stock: 1/16" - 1/8"  
Spacers: 1/8", cut 3

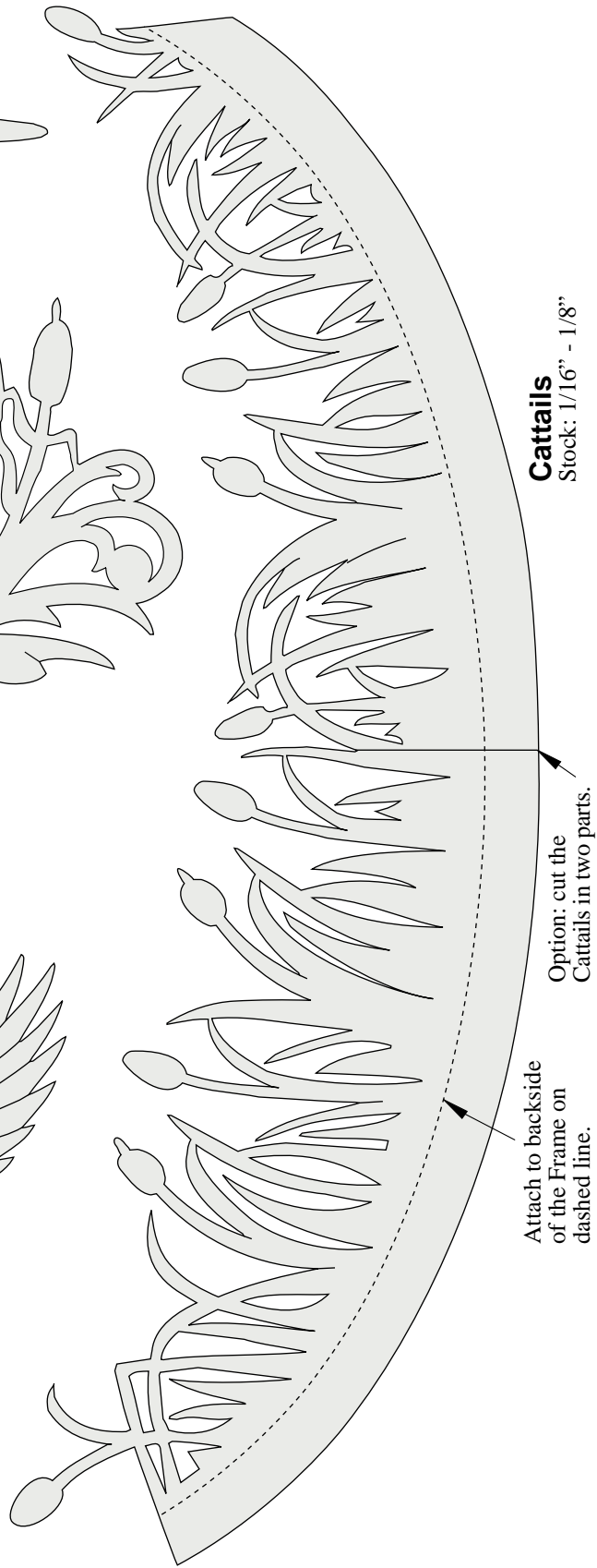
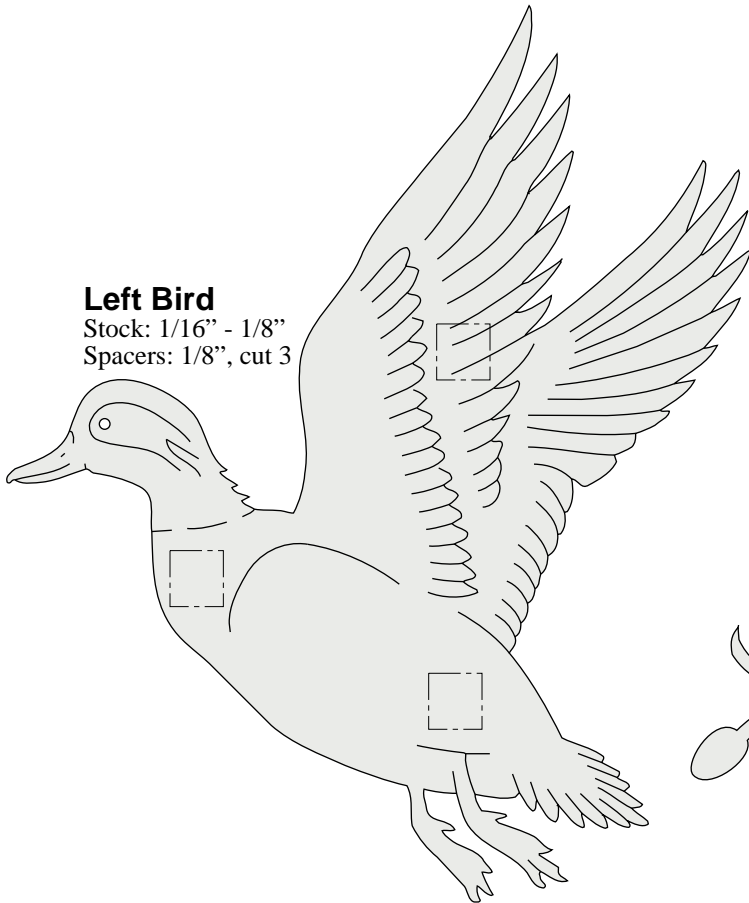

**Cattails**  
Stock: 1/16" - 1/8"

Option: cut the Cattails in two parts.

Attach to backside of the Frame on dashed line.

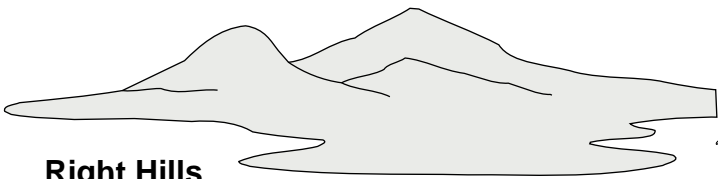

**Right Hills**  
Stock: 1/16" - 1/8"

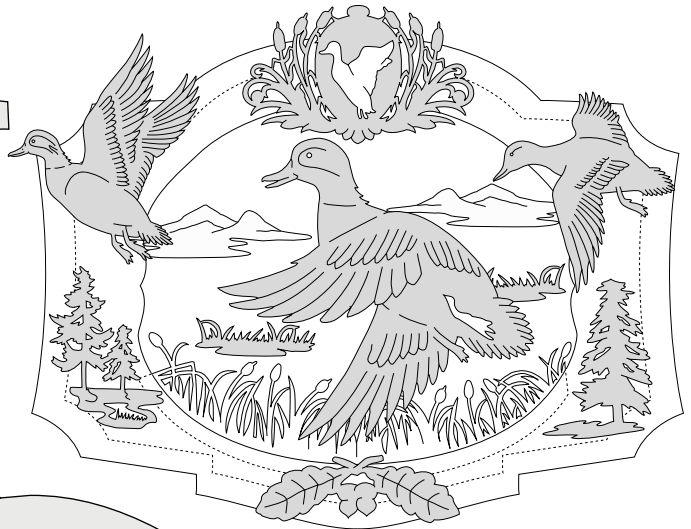

**Green-Winged Teal**

**Center Bird**  
Stock: 1/16" - 1/8"  
Spacers: 3/8", cut 4

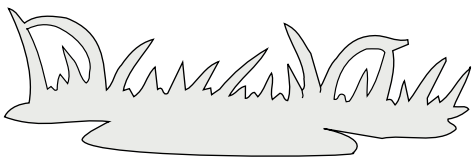
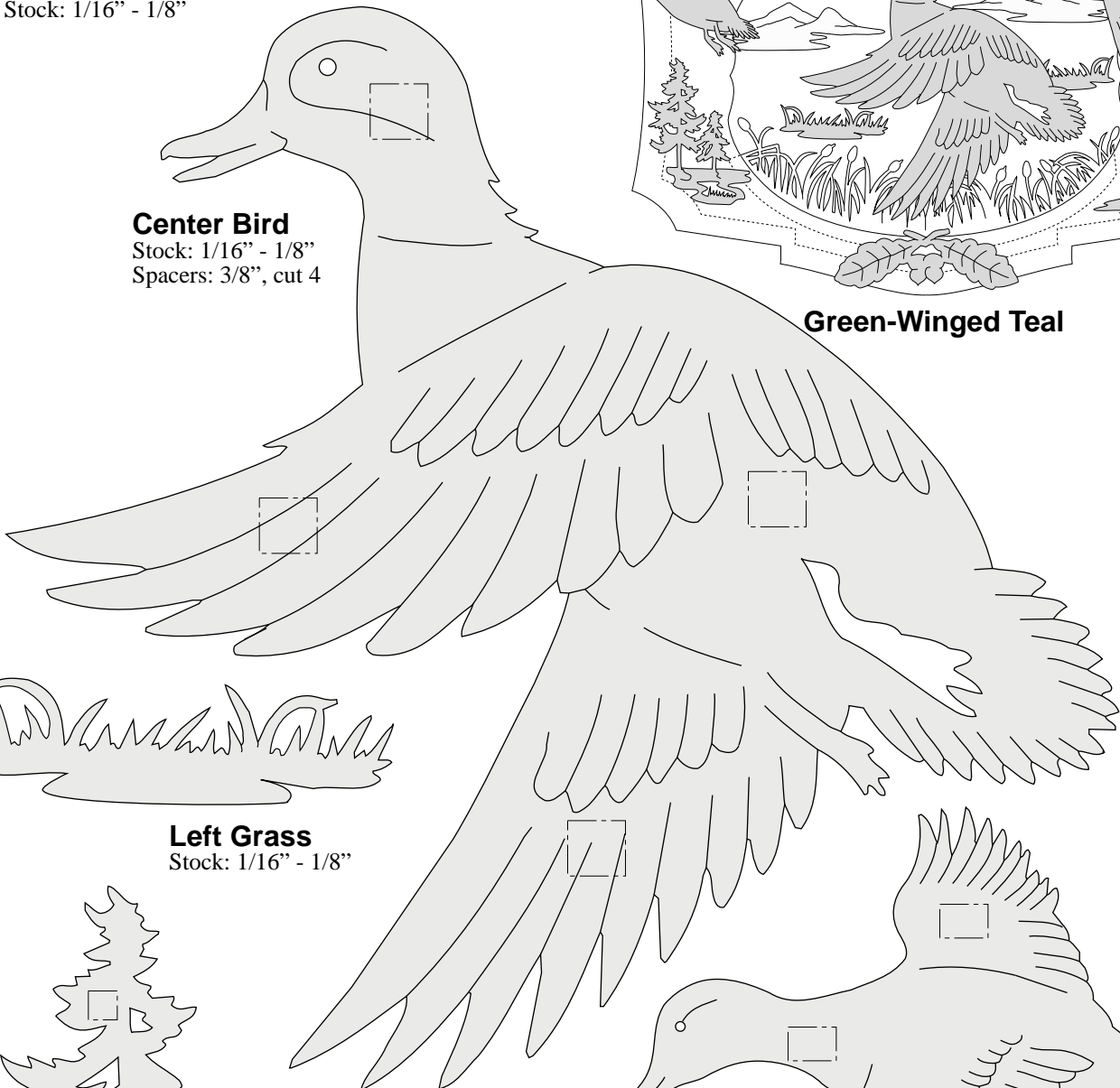

**Left Grass**  
Stock: 1/16" - 1/8"



**Left Tree**  
Stock: 1/16" - 1/8"  
Spacers: 1/8", cut 3

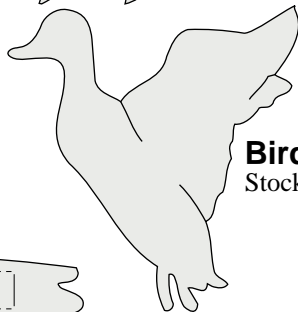

**Bird Overlay**  
Stock: 1/16"

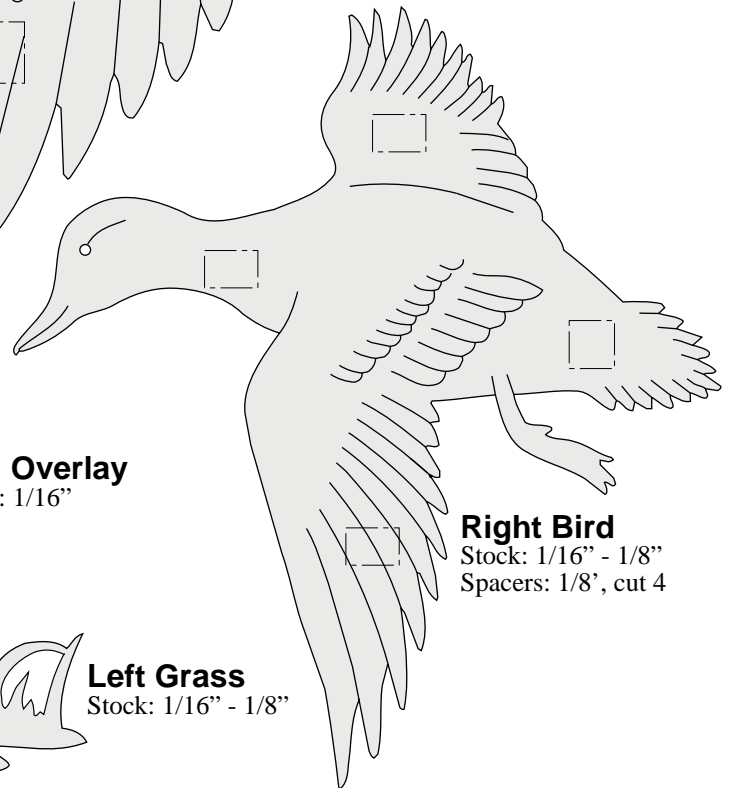

**Right Bird**  
Stock: 1/16" - 1/8"  
Spacers: 1/8", cut 4

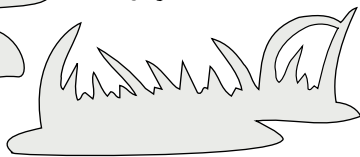

**Left Grass**  
Stock: 1/16" - 1/8"

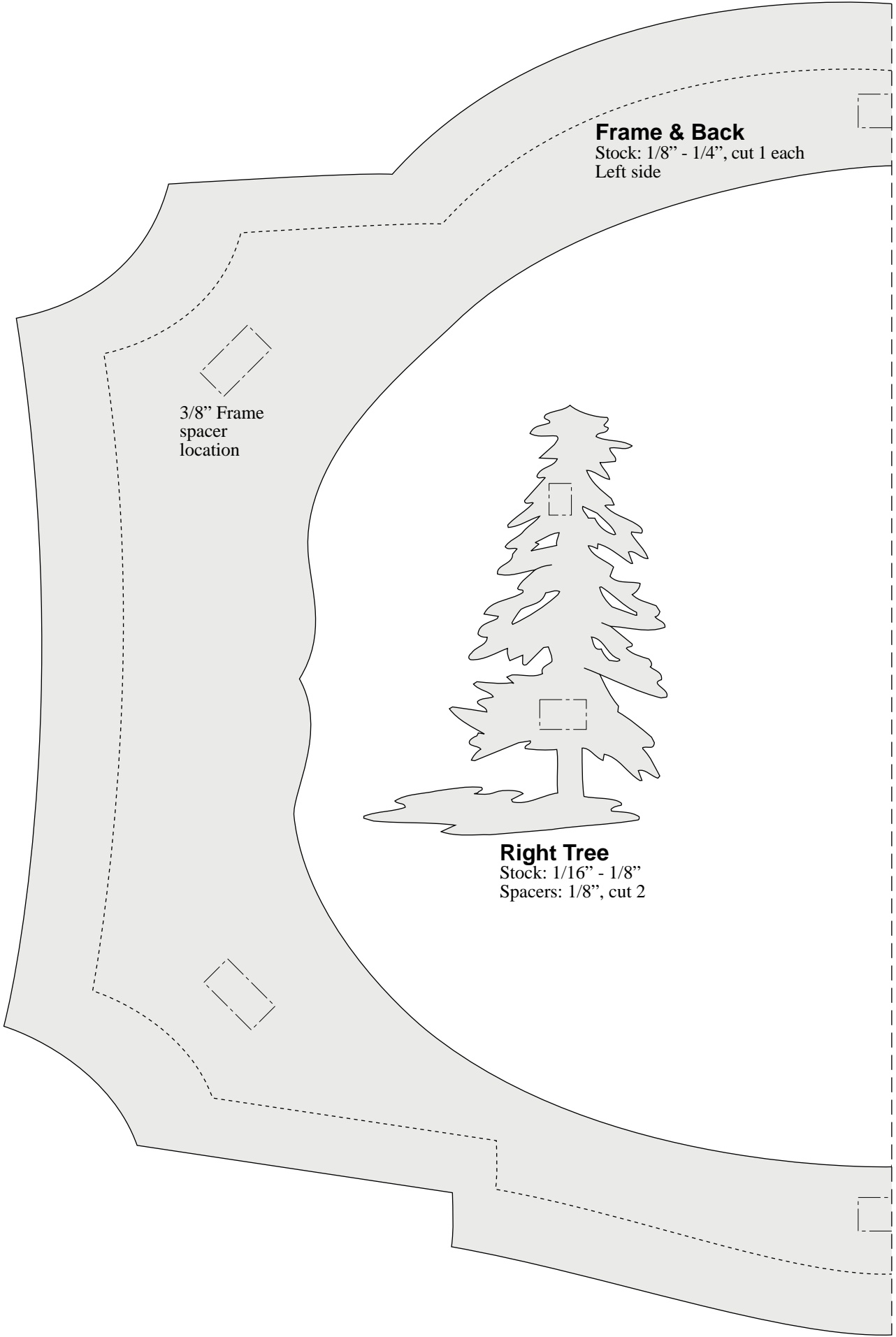

**Frame & Back**

Stock: 1/8" - 1/4", cut 1 each  
Left side

3/8" Frame  
spacer  
location

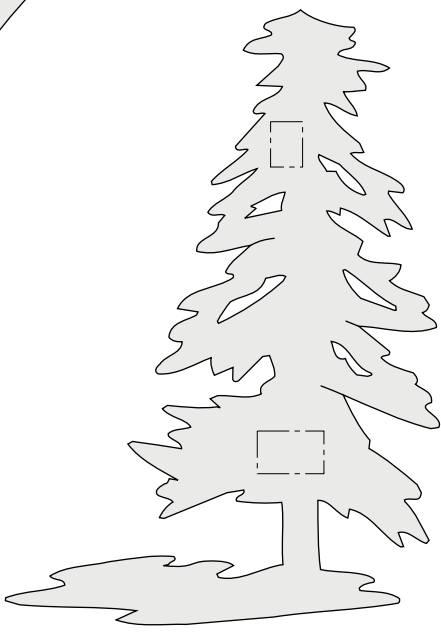

**Right Tree**

Stock: 1/16" - 1/8"  
Spacers: 1/8", cut 2

Pattern overlap line

Pattern overlap line

Cut 6 spacer blocks from  
3/8" thick material to  
separate Frame from Back.

Right side

Cut on dashed line  
for Back

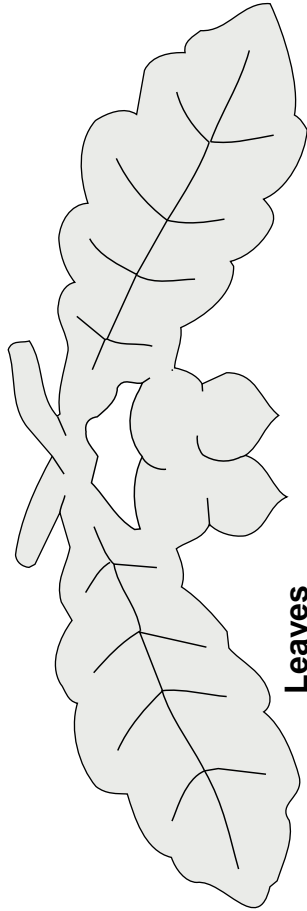
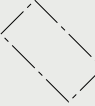

**Leaves**

Stock: 1/16" - 1/8"

Cut on solid line  
for Frame only.

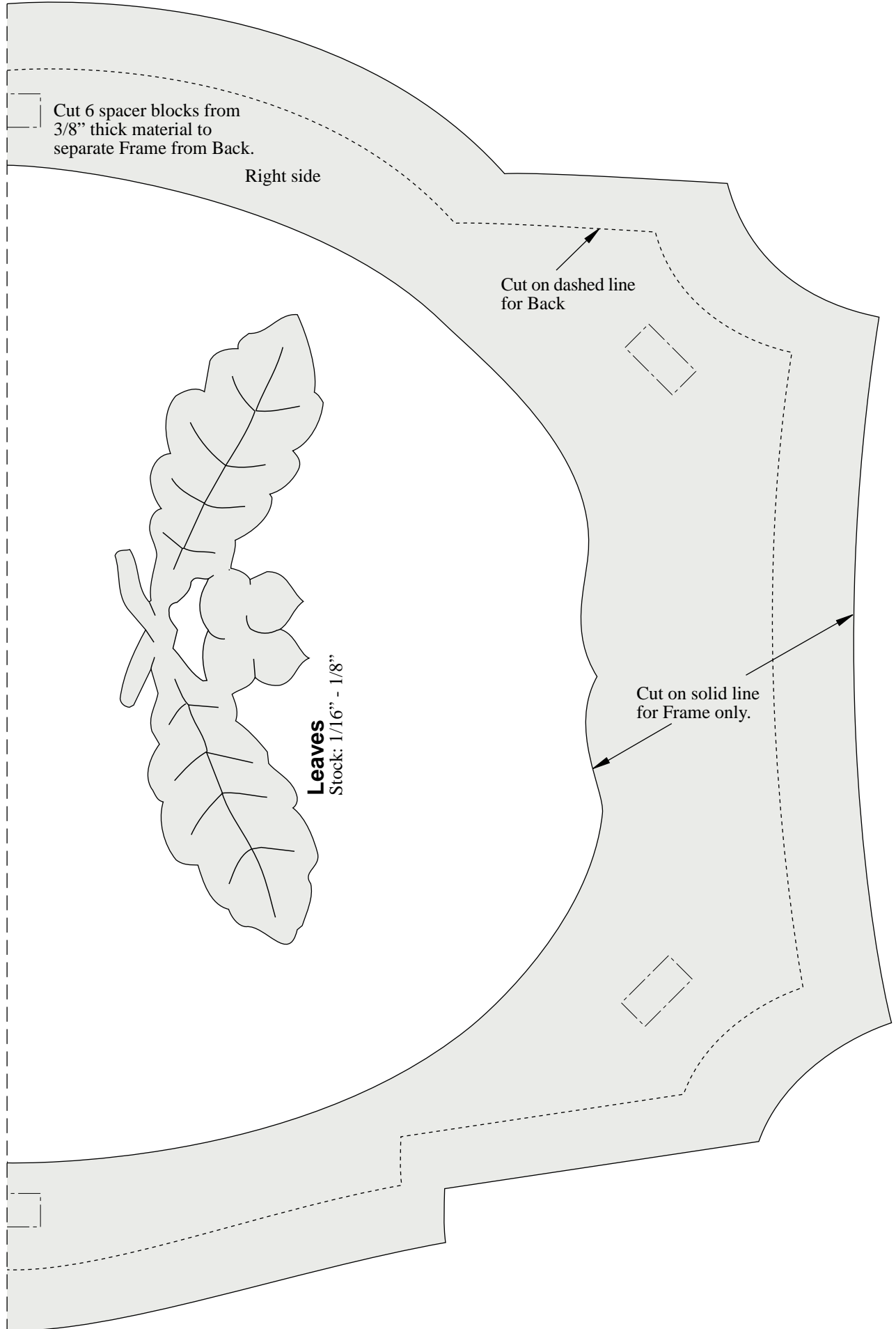
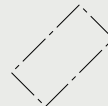

**Top Left Bird**

Stock: 1/16 - 1/8"  
Spacers: 1/8", cut 2

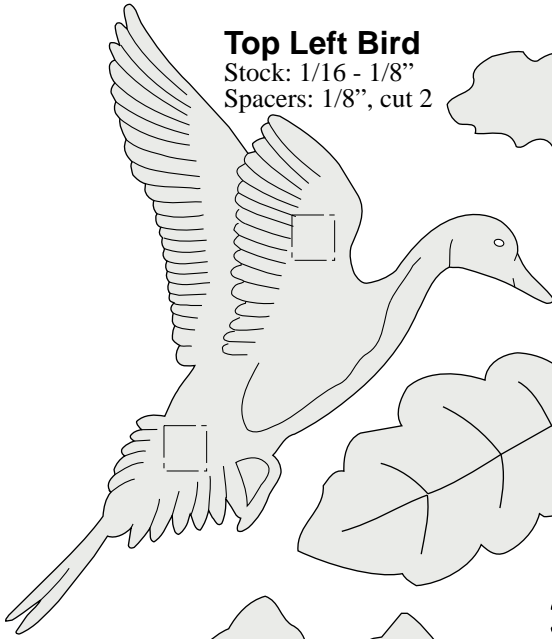

**Left Cloud**

Stock: 1/16 - 1/8"

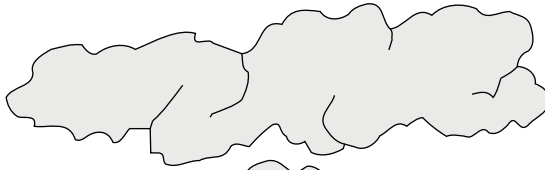

**Center Cloud**

Stock: 1/16 - 1/8"  
Spacers: 1/8", cut 2

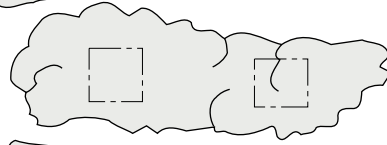

**Leaves**

Stock: 1/16 - 1/8"

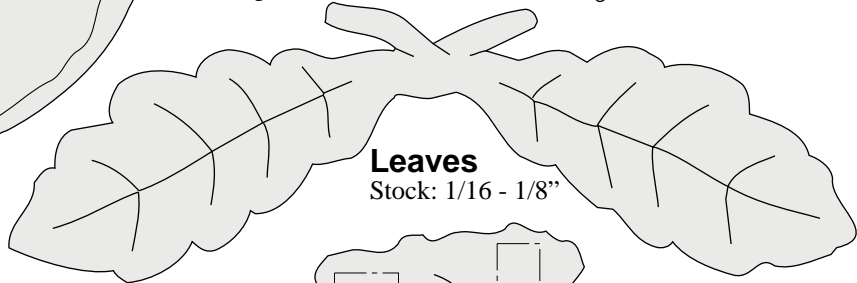

**Right Cloud**

Stock: 1/16 - 1/8"  
Spacers: 1/8", cut 2

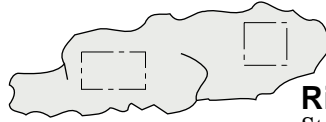

**Left Mountains**

Stock: 1/16 - 1/8"

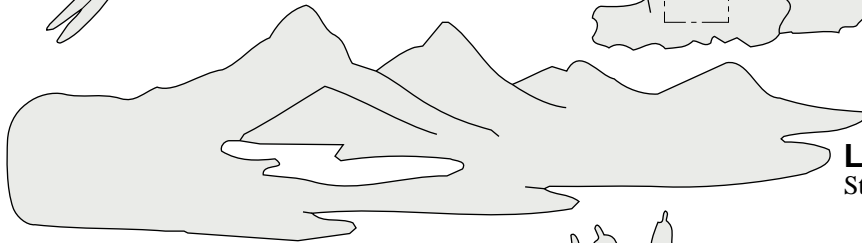

**Left Cattails**

Stock: 1/16 - 1/8"  
Spacers: 1/8", cut 2

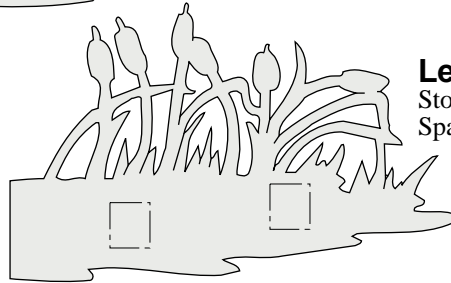

**Bottom Leaves**

Stock: 1/16 - 1/8"

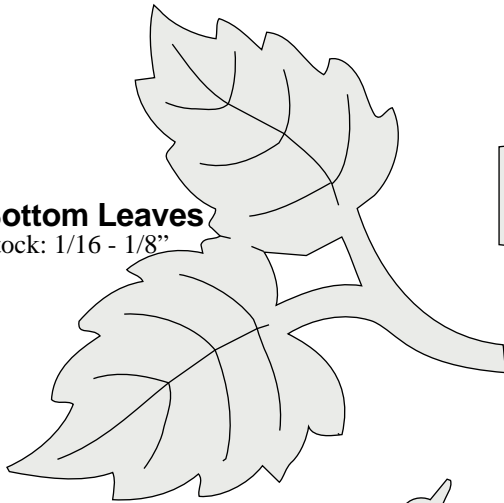

**Right Mountains**

Stock: 1/16 - 1/8"

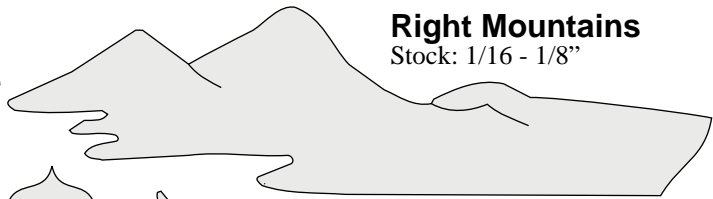

**Bottom Overlay**

Stock: 1/16 - 1/8"

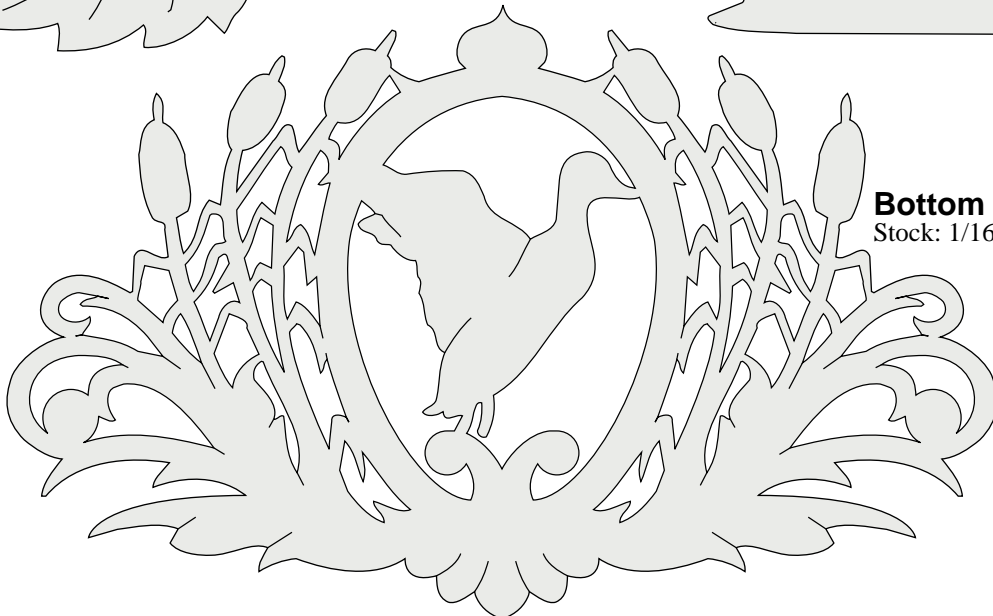

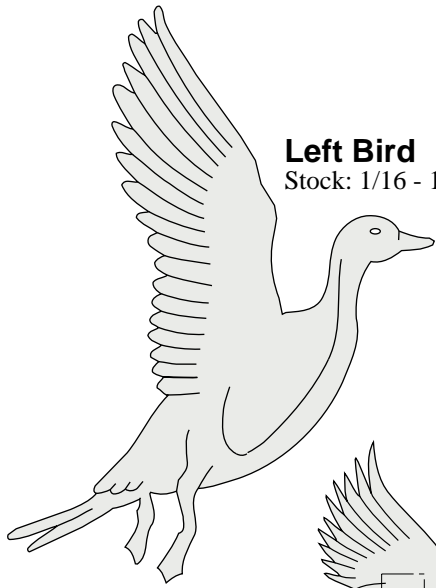

**Left Bird**  
Stock: 1/16 - 1/8"

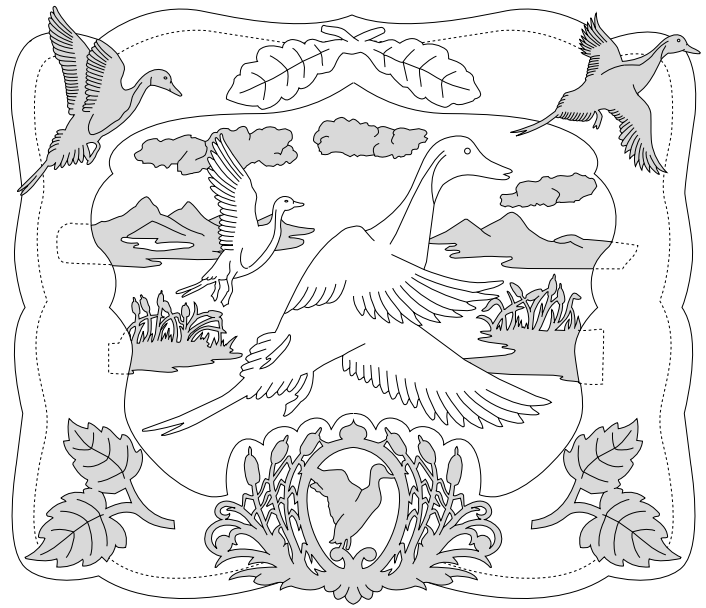

**Pintail Drake**

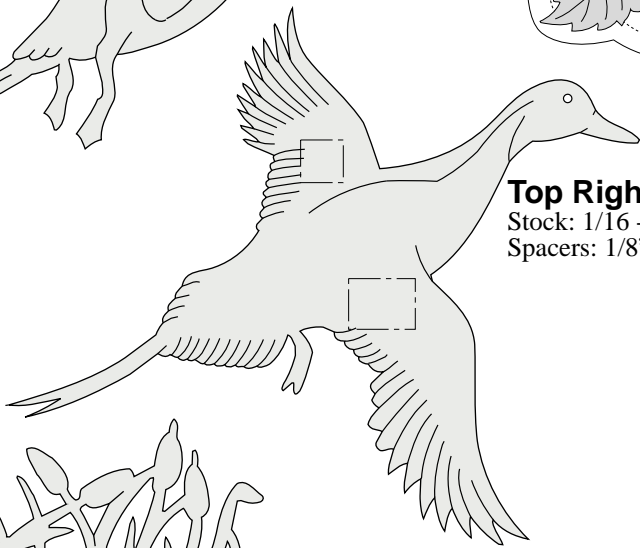

**Top Right Bird**  
Stock: 1/16 - 1/8"  
Spacers: 1/8", cut 2

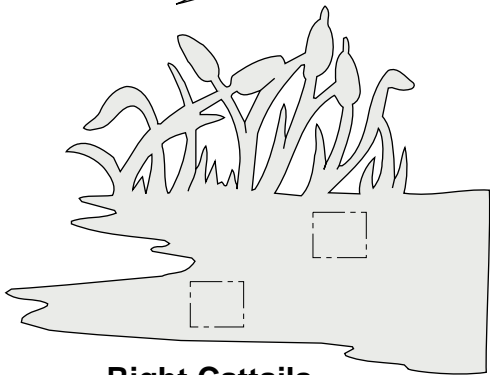

**Right Cattails**  
Stock: 1/16 - 1/8"  
Spacers: 1/8", cut 2

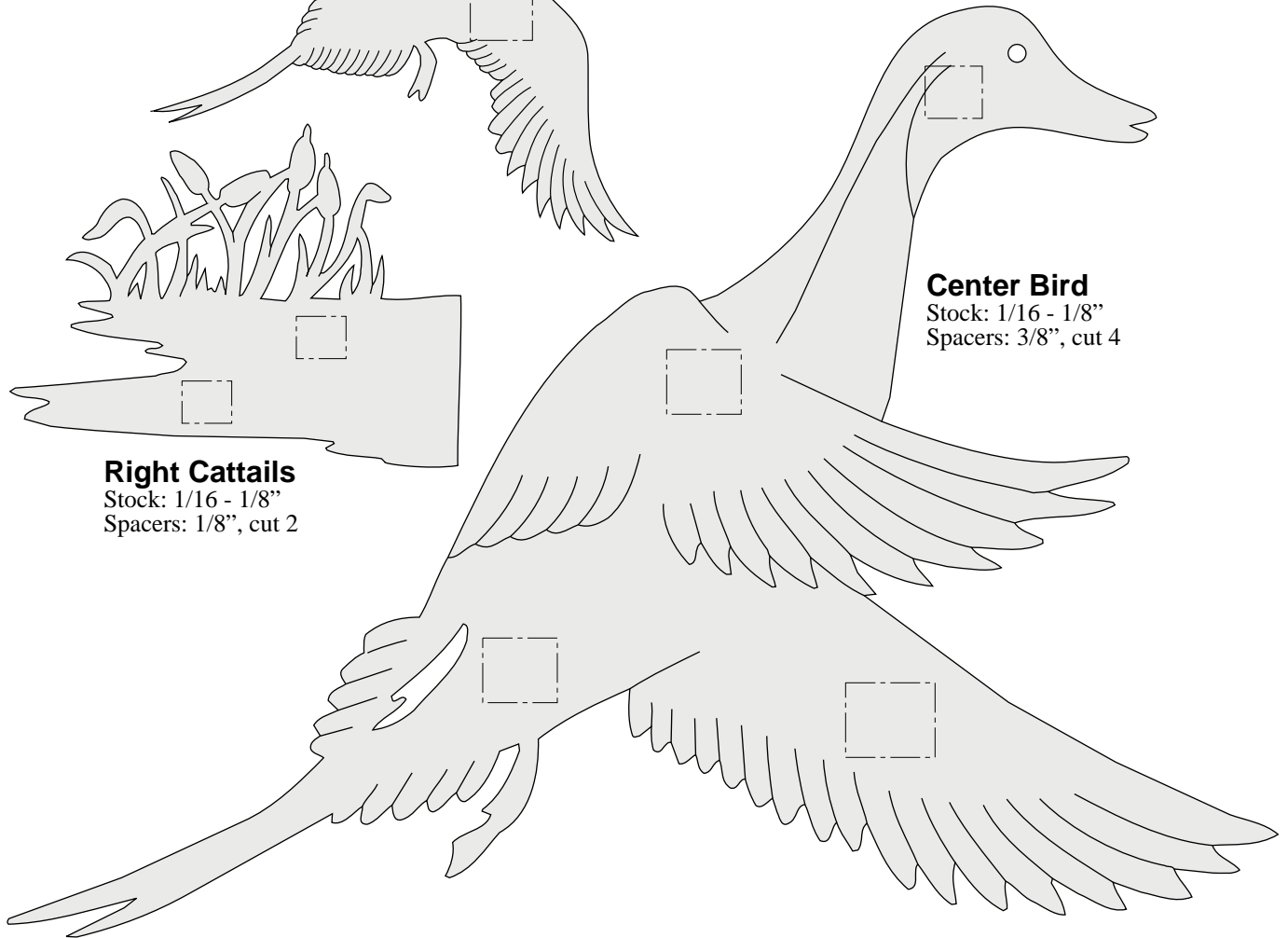

**Center Bird**  
Stock: 1/16 - 1/8"  
Spacers: 3/8", cut 4

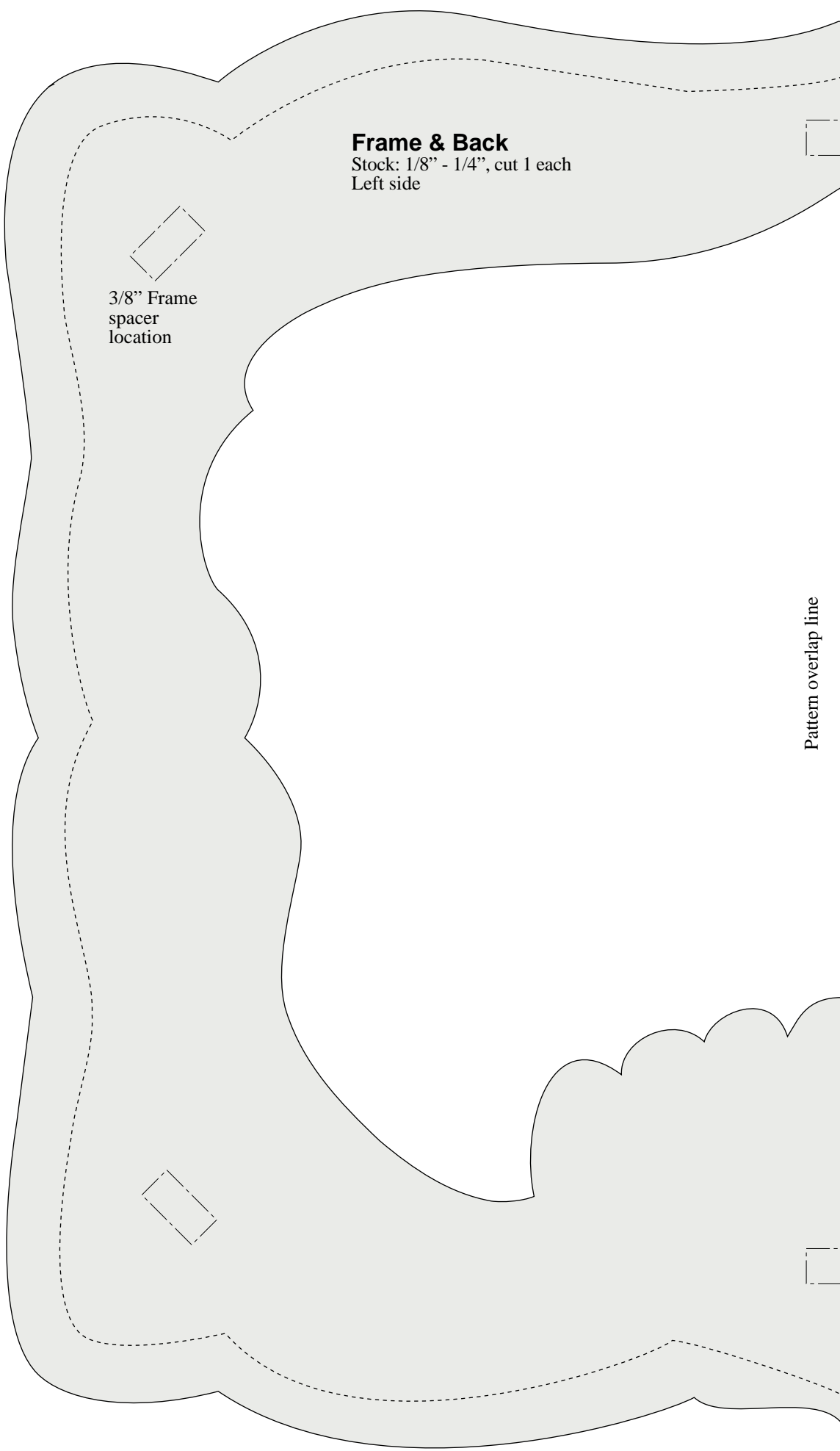

**Frame & Back**  
Stock: 1/8" - 1/4", cut 1 each  
Left side

3/8" Frame  
spacer  
location

Pattern overlap line



Pattern overlap line

Cut 6 spacer blocks from  
3/8" thick material to  
separate Frame from Back.

Cut on dashed line  
for Back

Right side

Cut on solid line  
for Frame only.

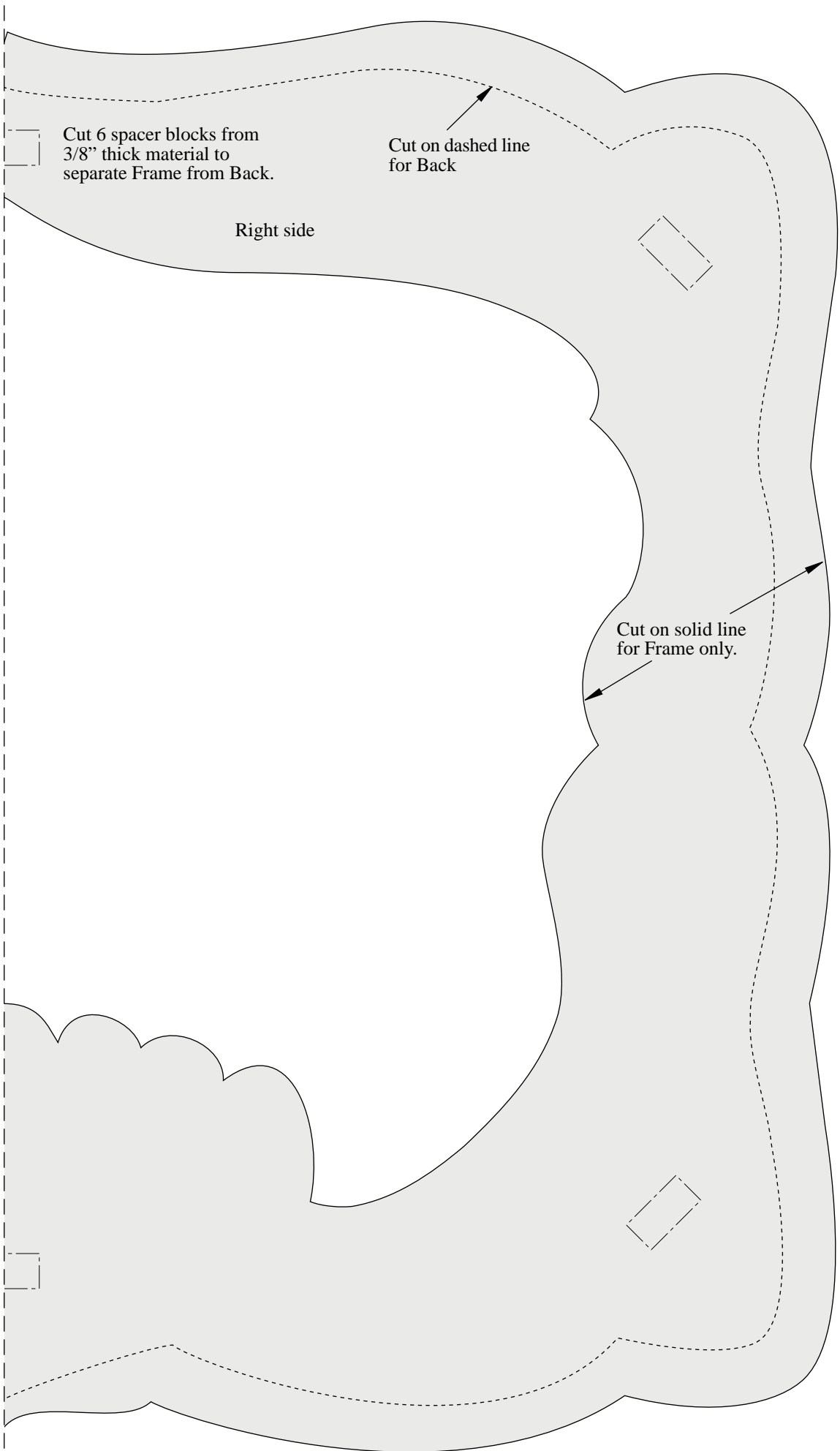

**Left Bird**

Stock: 1/16" - 1/8"  
Spacers: 1/8", cut 3

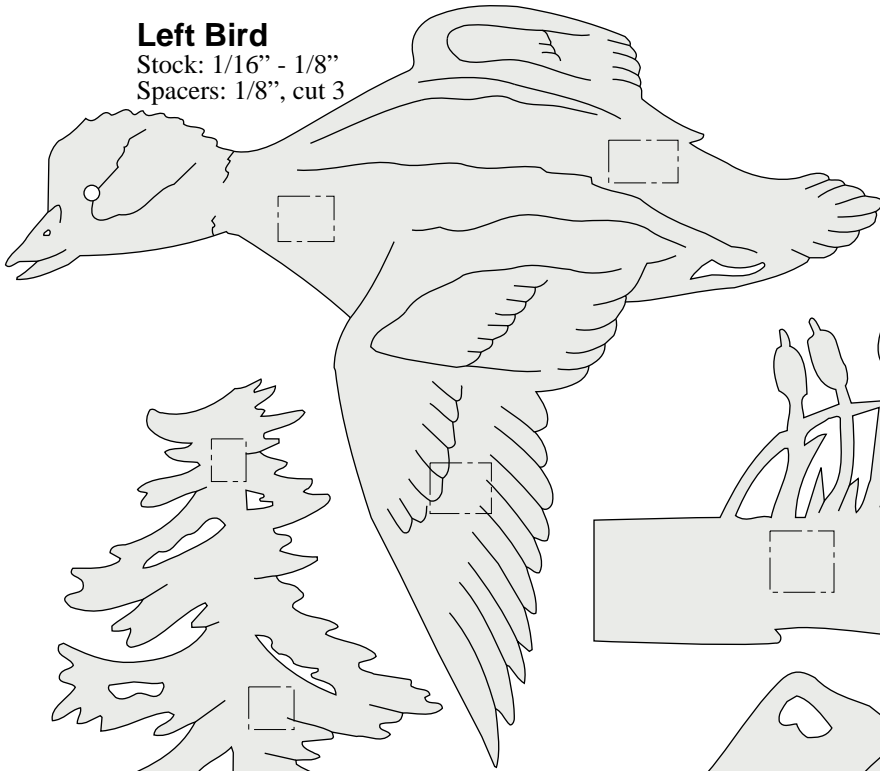

**Back Left Bird**

Stock: 1/16" - 1/8"  
Spacer: 1/4"

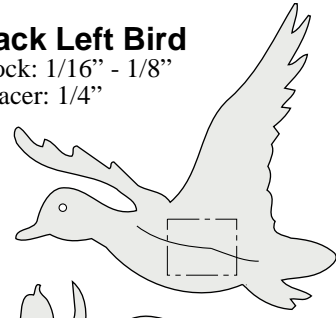

**Left Cattails**

Stock: 1/16" - 1/8"  
Spacers: 1/8", cut 2

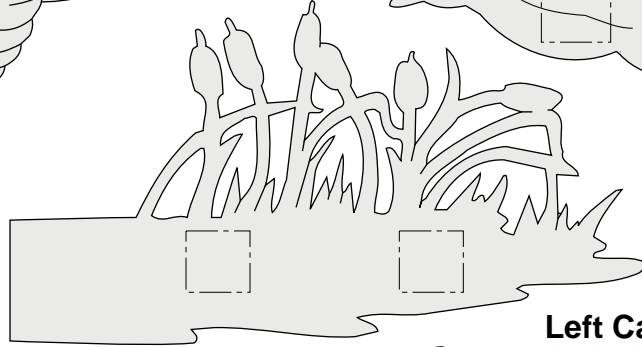

**Left Mountains**

Stock: 1/16" - 1/8"

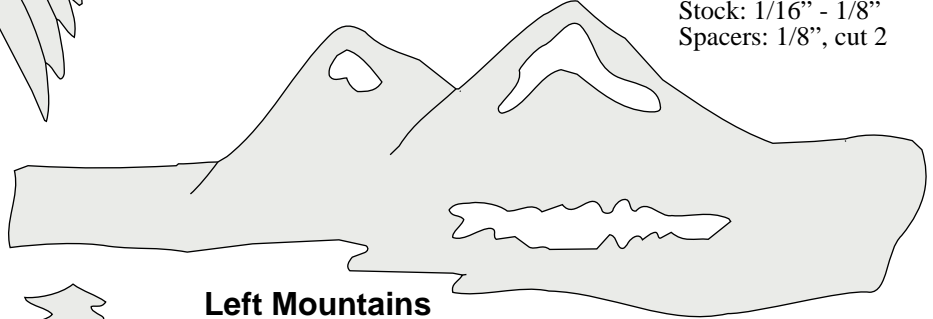

**Left Tree**

Stock: 1/16" - 1/8"  
Spacers: 1/8", cut 3

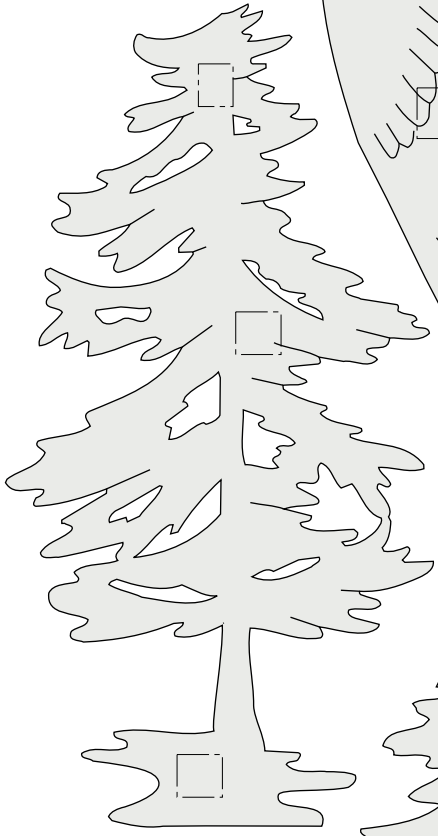

**Leaves**

Stock: 1/16" - 1/8", cut 2

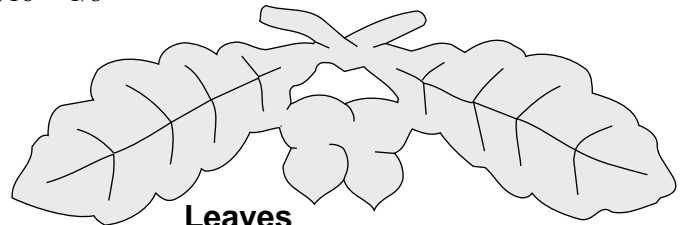

**Right Tree**

Stock: 1/16" - 1/8"  
Spacers: 1/8", cut 3



**Right Cattails**

Stock: 1/16" - 1/8"  
Spacers: 1/8", cut 2

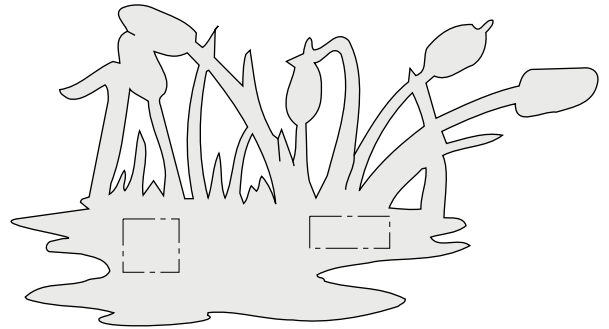

**Back Right Bird**

Stock: 1/16" - 1/8"  
Spacer: 1/4"

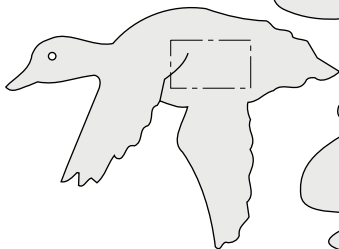

**Right Mountains**

Stock: 1/16" - 1/8"  
Spacers:

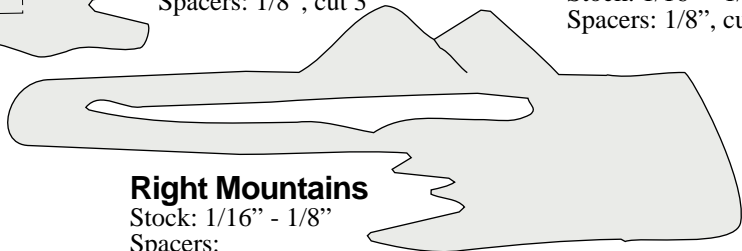

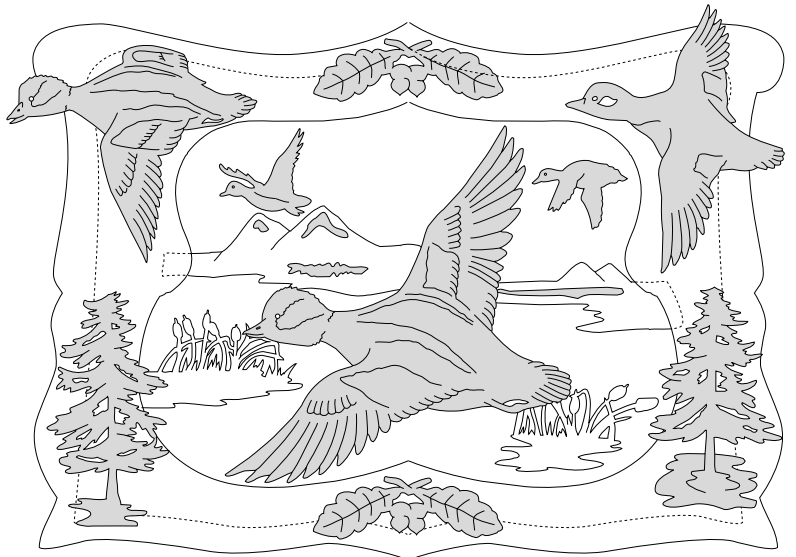

**Bufflehead**

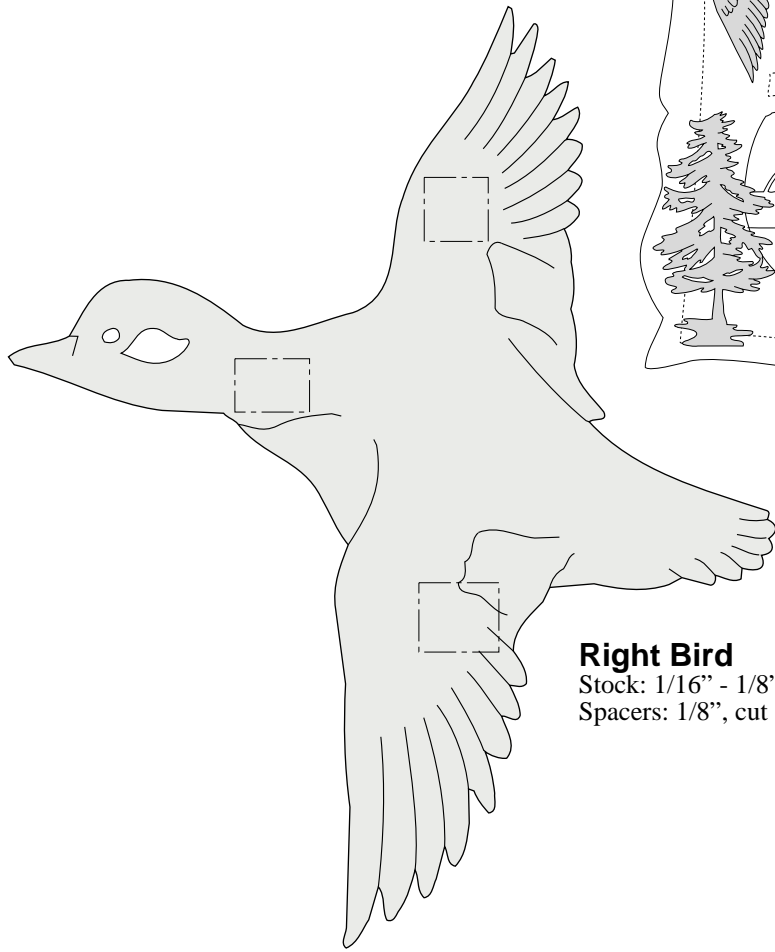

**Right Bird**  
Stock: 1/16" - 1/8"  
Spacers: 1/8", cut 3

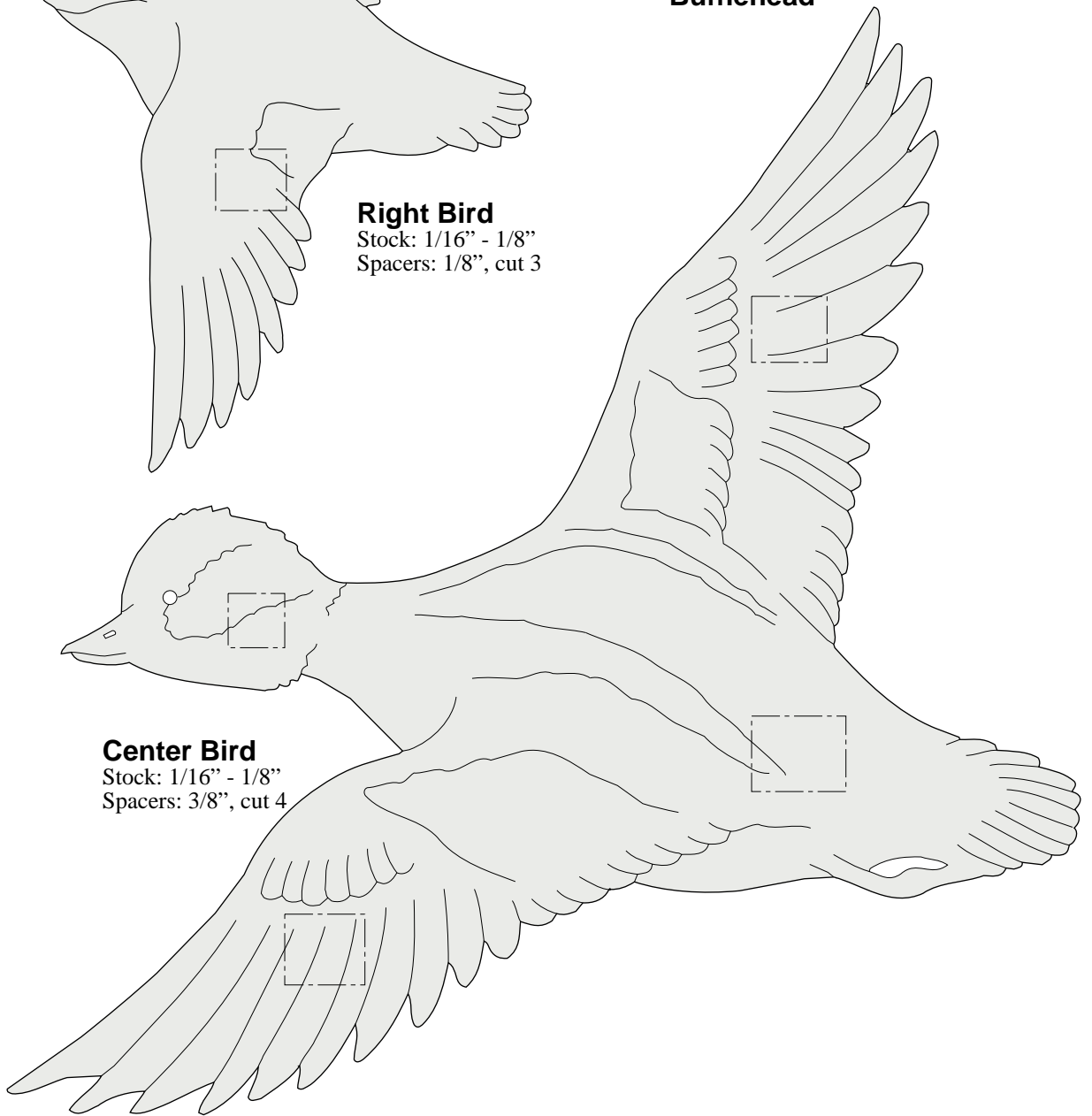

**Center Bird**  
Stock: 1/16" - 1/8"  
Spacers: 3/8", cut 4

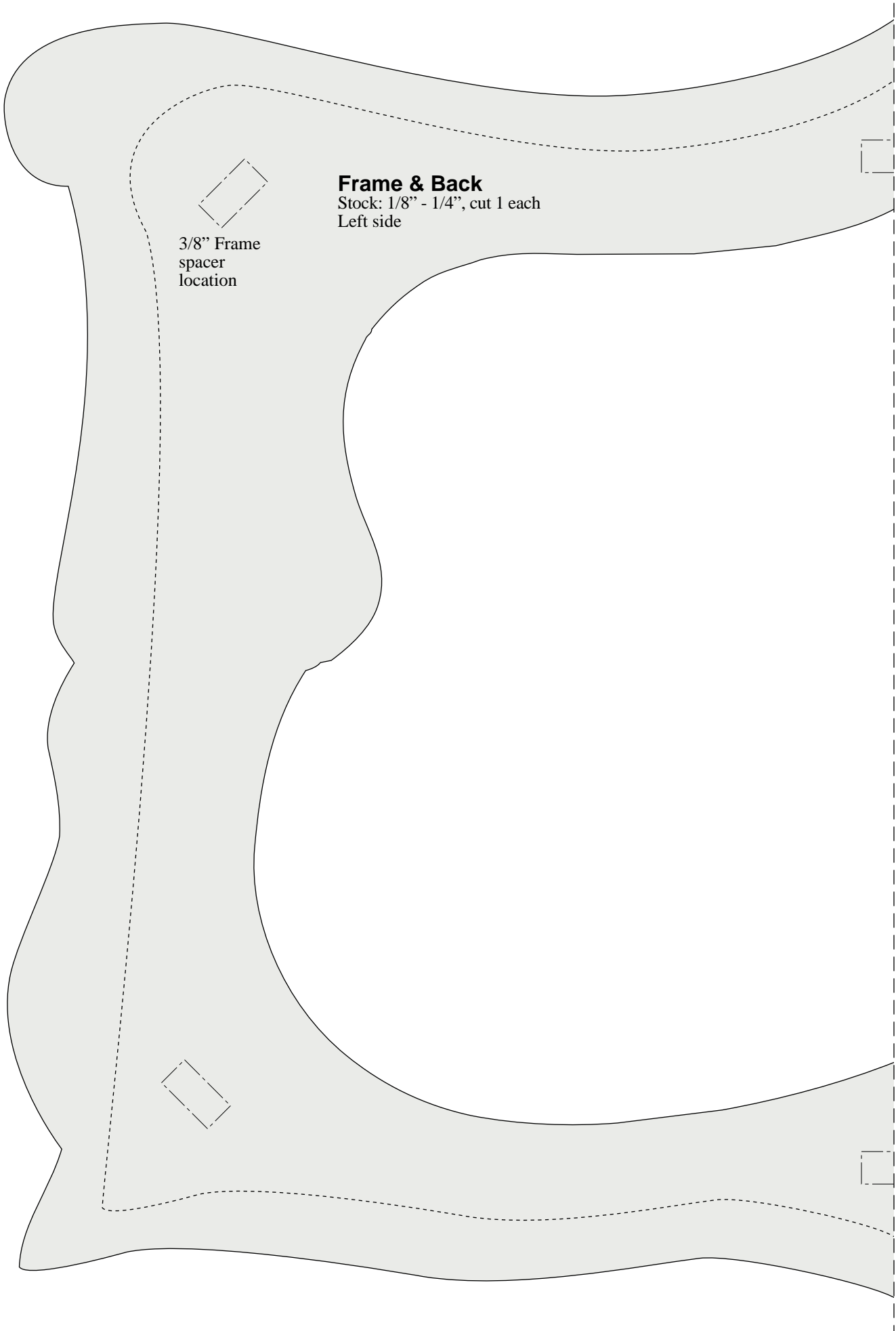

**Frame & Back**

Stock: 1/8" - 1/4", cut 1 each  
Left side

3/8" Frame  
spacer  
location

Pattern overlap line

Pattern overlap line

Cut 6 spacer blocks from  
3/8" thick material to  
separate Frame from Back.

Right side

Cut on dashed line  
for Back

Cut on solid line  
for Frame only.

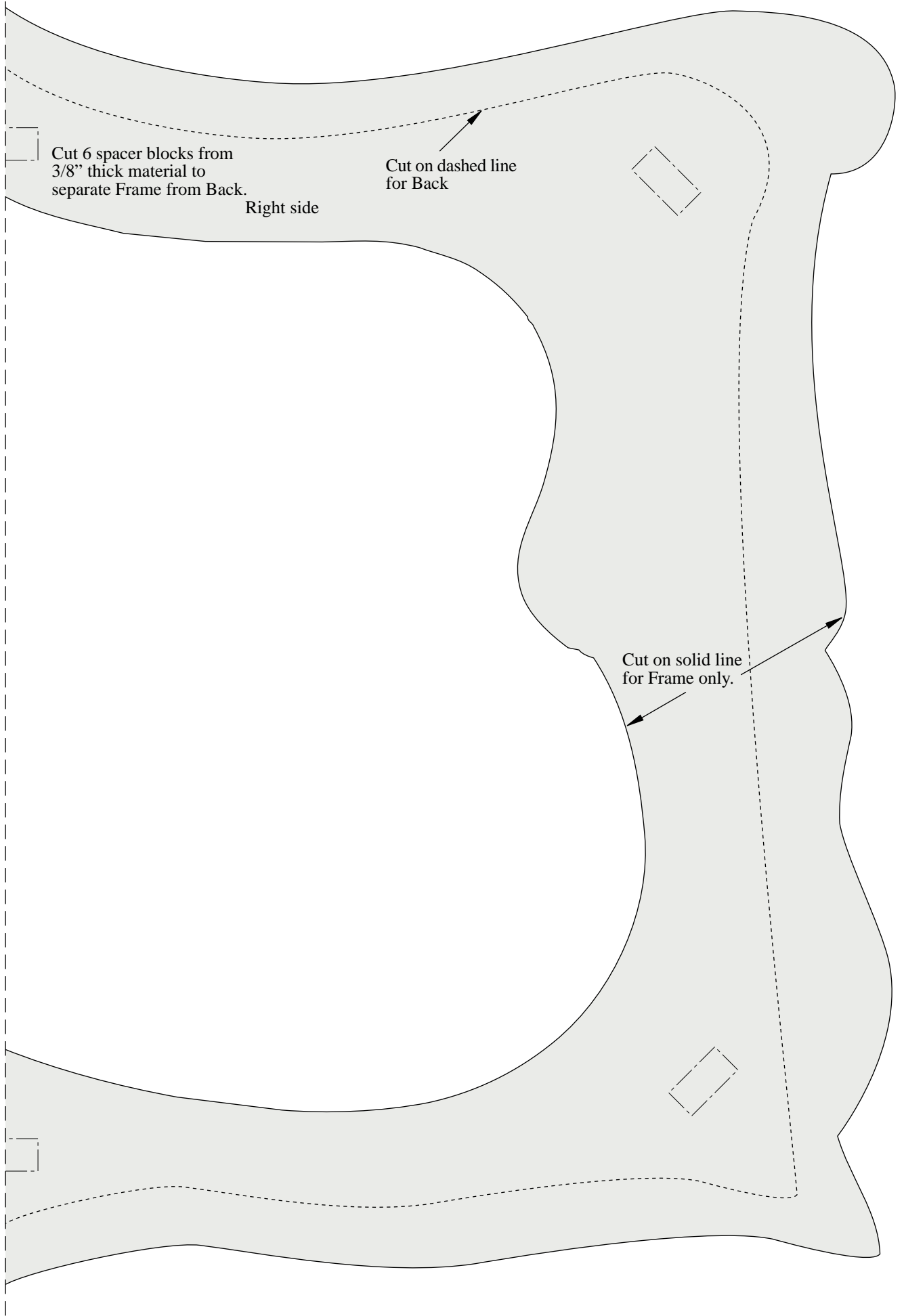

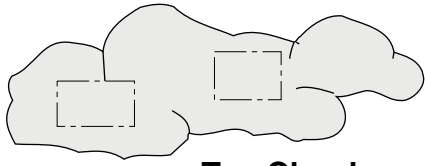

**Top Cloud**  
Stock: 1/16" - 1/8"  
Spacers: 1/8", cut 2

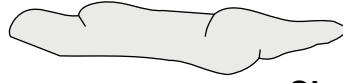

**Clouds**  
Stock: 1/16" - 1/8"

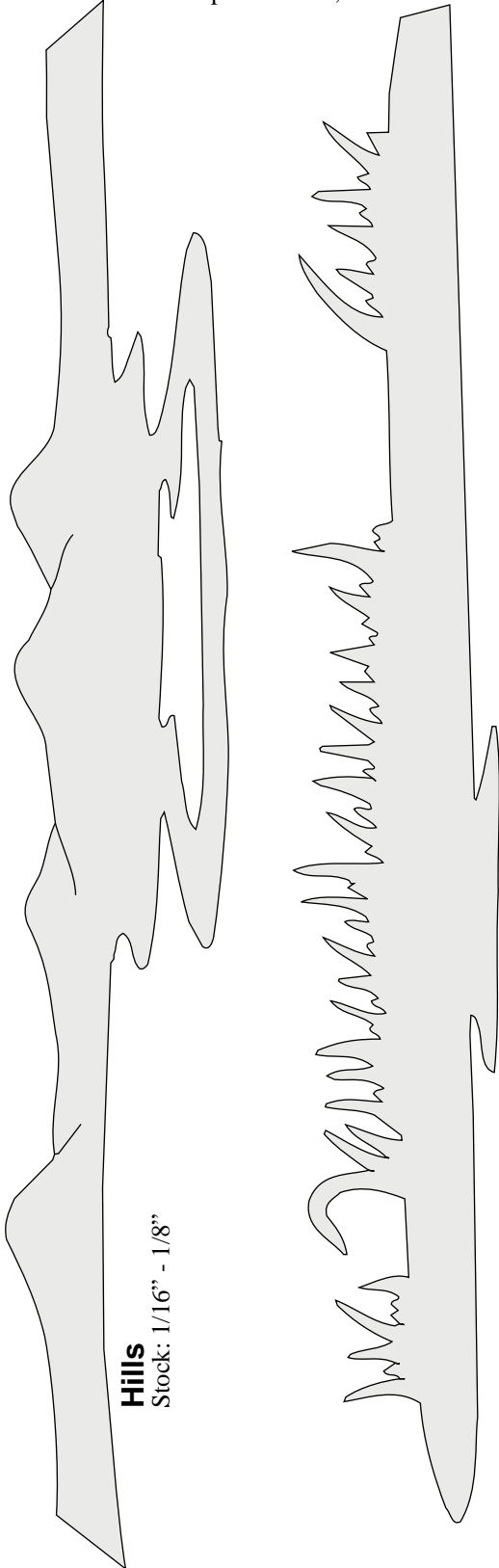

**Hills**  
Stock: 1/16" - 1/8"

**Grass**  
Stock: 1/16" - 1/8"

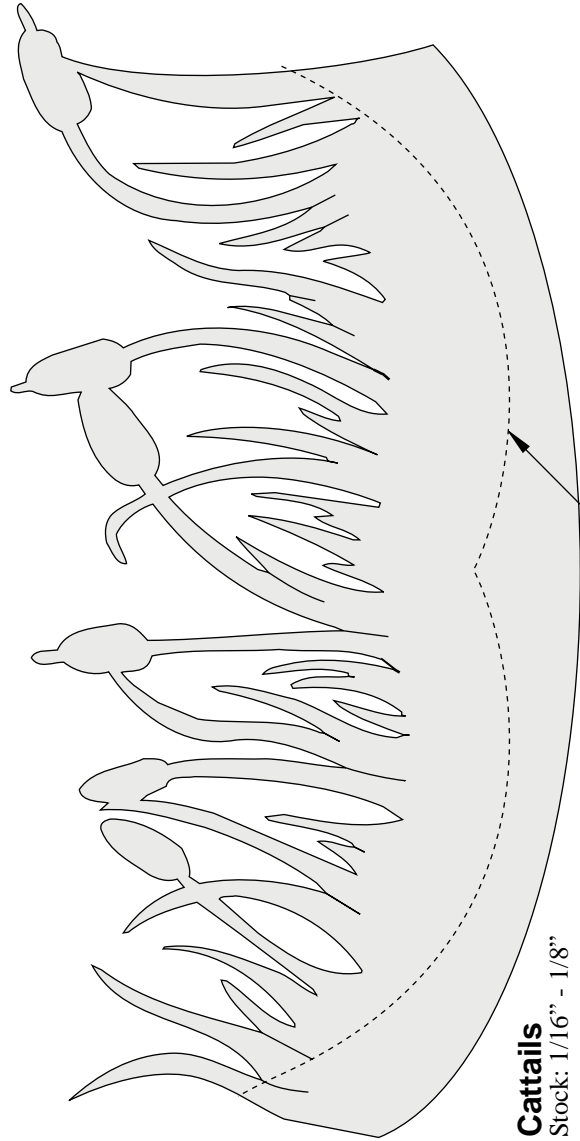

**Cattails**  
Stock: 1/16" - 1/8"

Attach to backside of the  
Frame on dashed line.

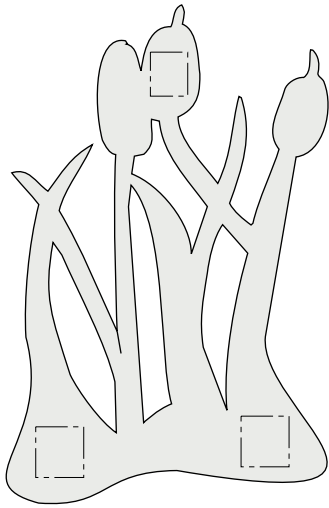

**Front Cattails**  
Stock: 1/16" - 1/8", cut 2  
Spacers: 1/8", cut 6

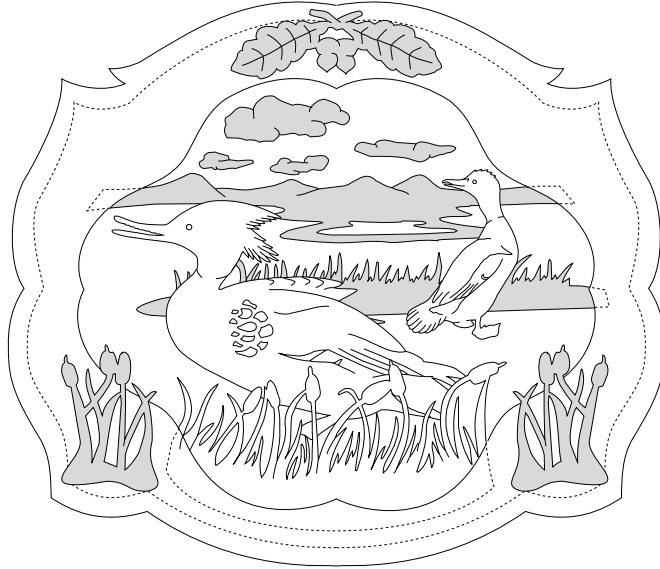

**American Merganser**

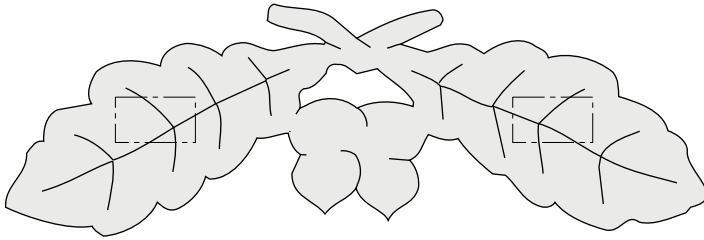

**Leaves**  
Stock: 1/16" - 1/8"  
Spacers: 1/8", cut 2

**Right Bird**  
Stock: 1/16" - 1/8"

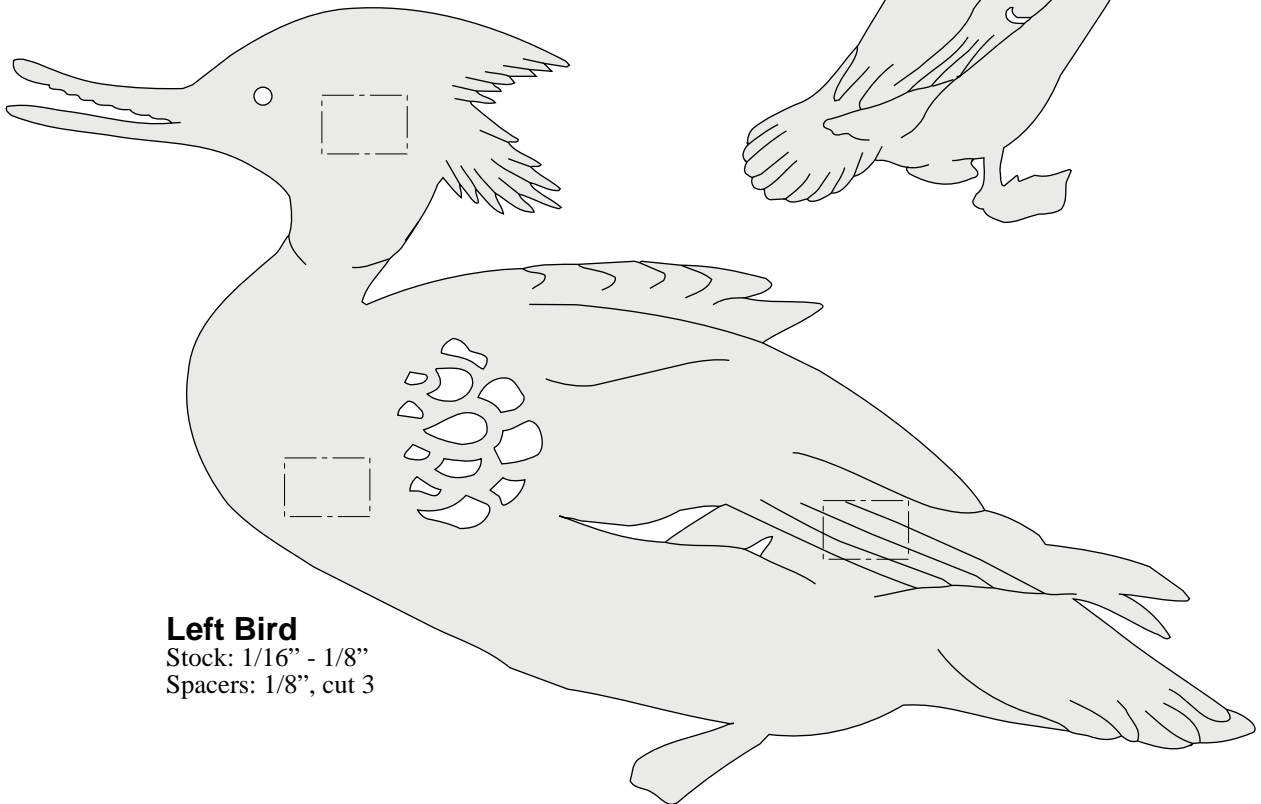
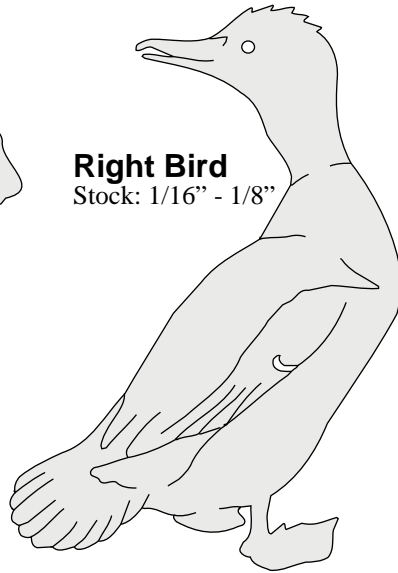

**Left Bird**  
Stock: 1/16" - 1/8"  
Spacers: 1/8", cut 3

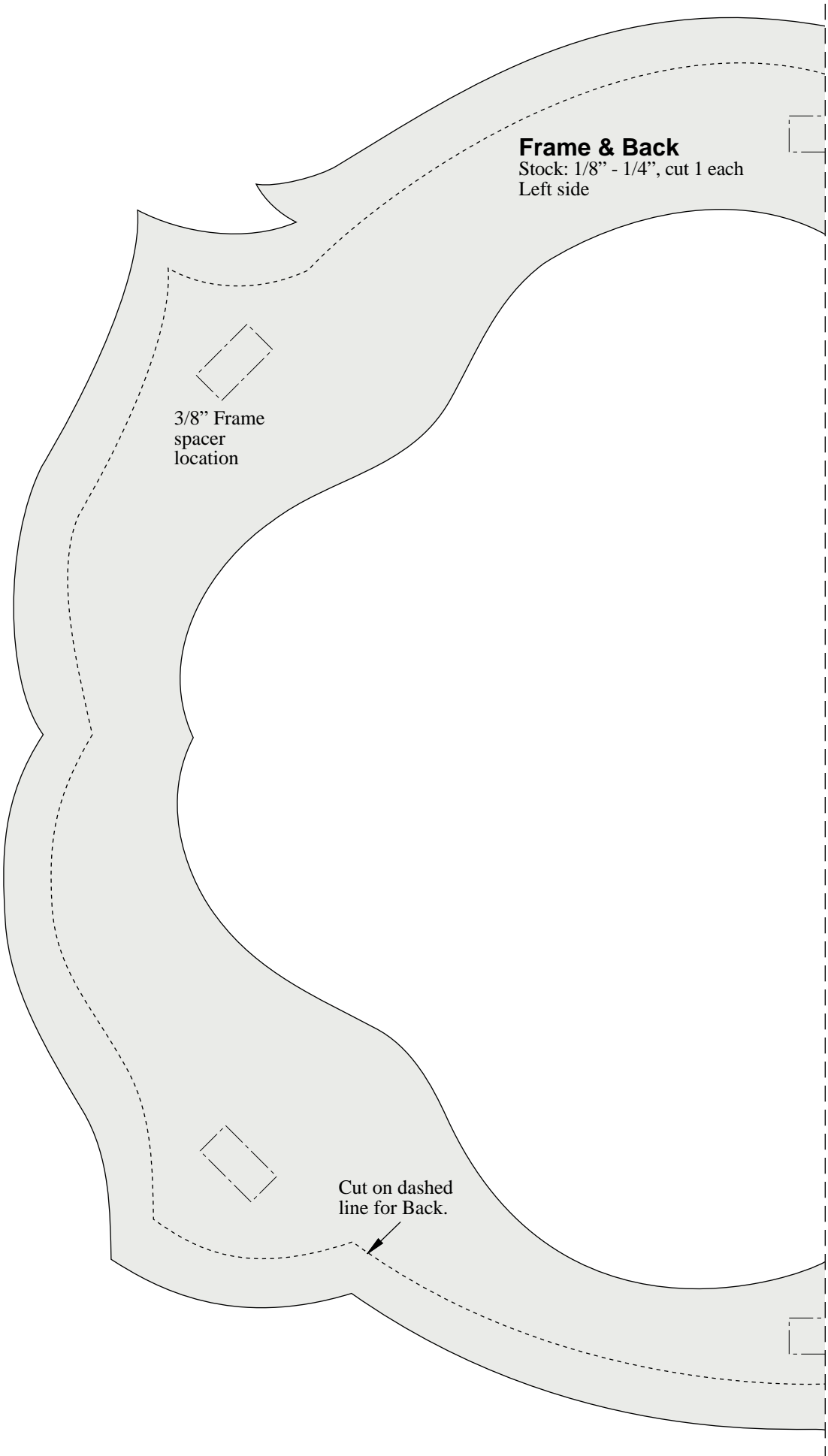

**Frame & Back**  
Stock: 1/8" - 1/4", cut 1 each  
Left side

3/8" Frame  
spacer  
location

Cut on dashed  
line for Back.

Pattern overlap line





Cut 6 spacer blocks from 3/8" thick material to separate Frame from Back.

Right side

Cut on solid line for Frame only.

Pattern overlap line

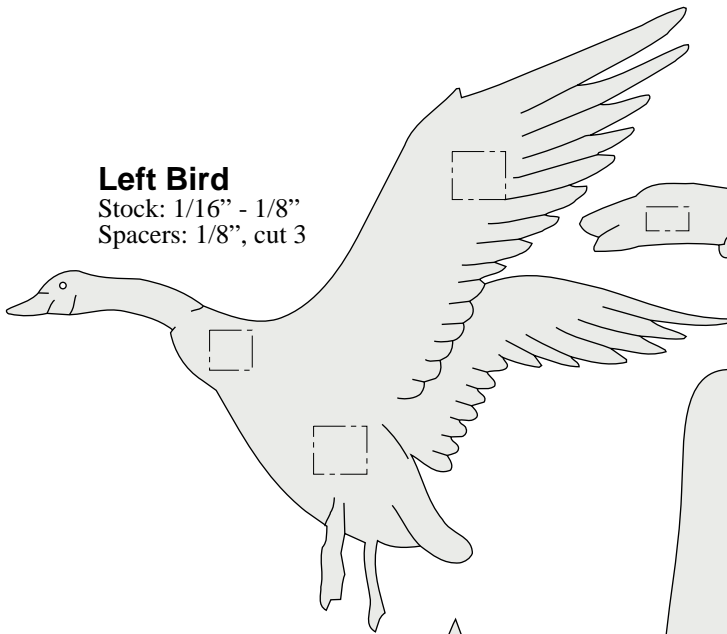

**Left Bird**  
Stock: 1/16" - 1/8"  
Spacers: 1/8", cut 3



**Left Cloud**  
Stock: 1/16" - 1/8"  
Spacers: 1/8", cut 2

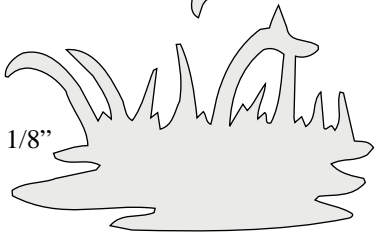

**Grass**  
Stock: 1/16" - 1/8"

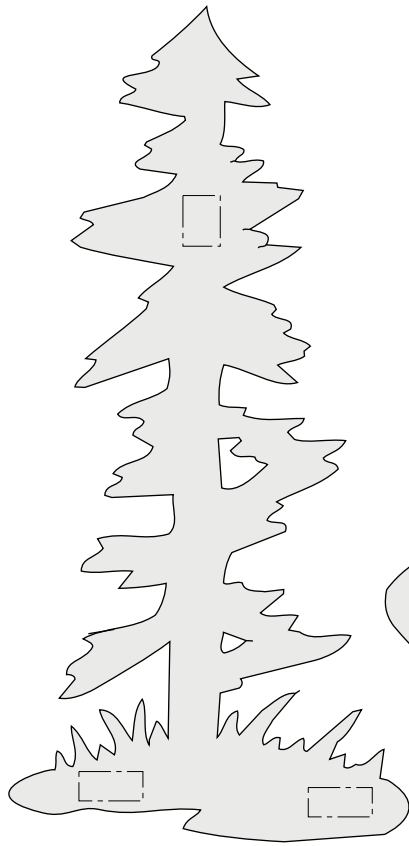

**Right Tree**  
Stock: 1/16" - 1/8"  
Spacers: 1/8", cut 3

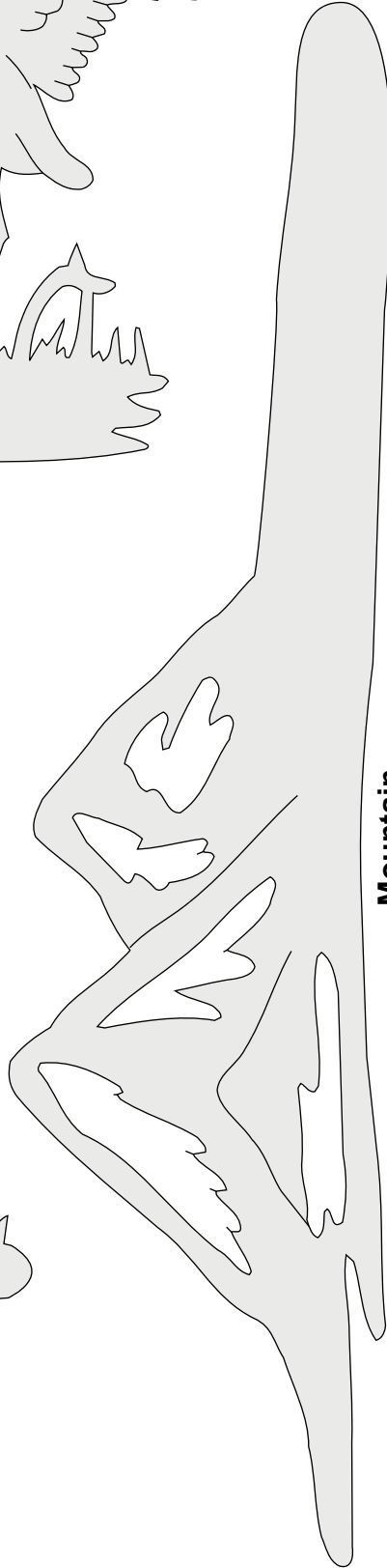

**Mountain**  
Stock: 1/16" - 1/8"

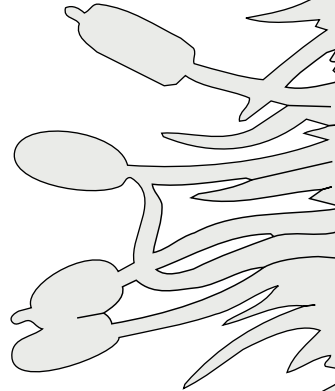

**Cattails**  
Stock: 1/16" - 1/8"

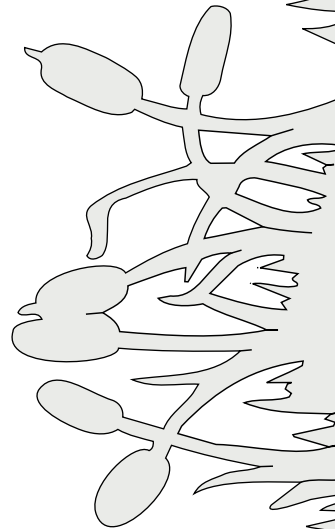

**Cattails**  
Stock: 1/16" - 1/8"

Optional: cut in half.

Attach to backside of the Frame on dashed line.

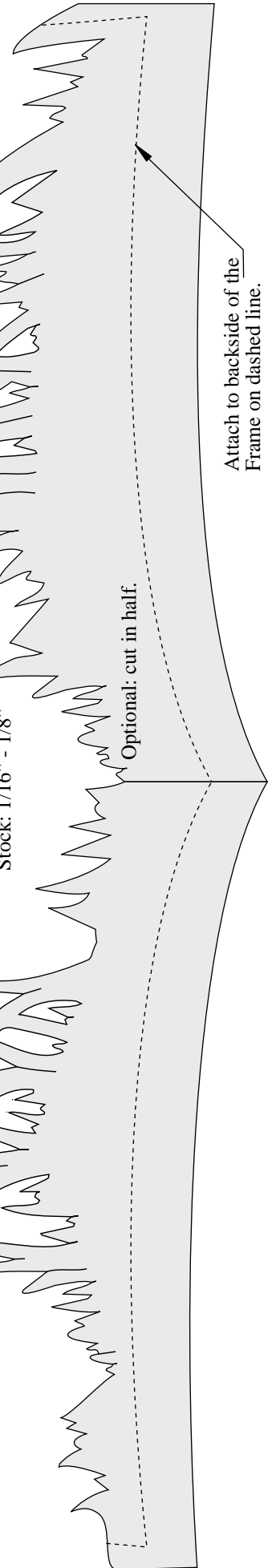

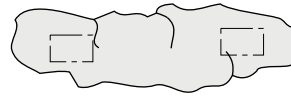

**Right Cloud**  
Stock: 1/16" - 1/8"  
Spacers: 1/8", cut 2

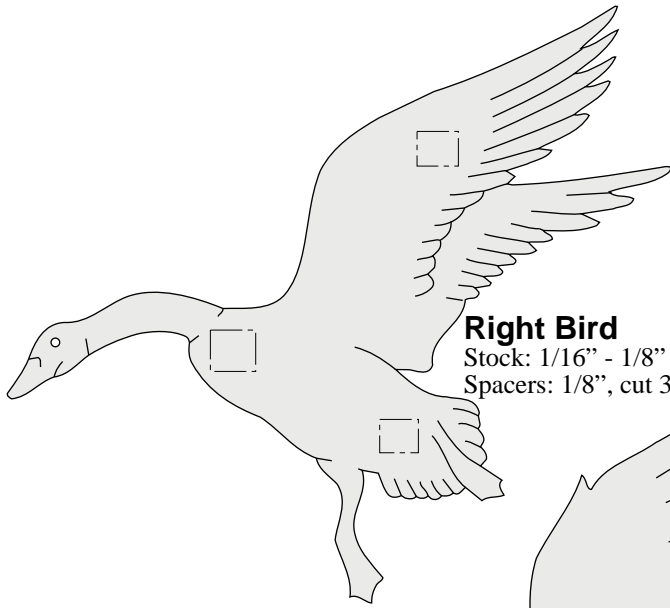

**Right Bird**  
Stock: 1/16" - 1/8"  
Spacers: 1/8", cut 3

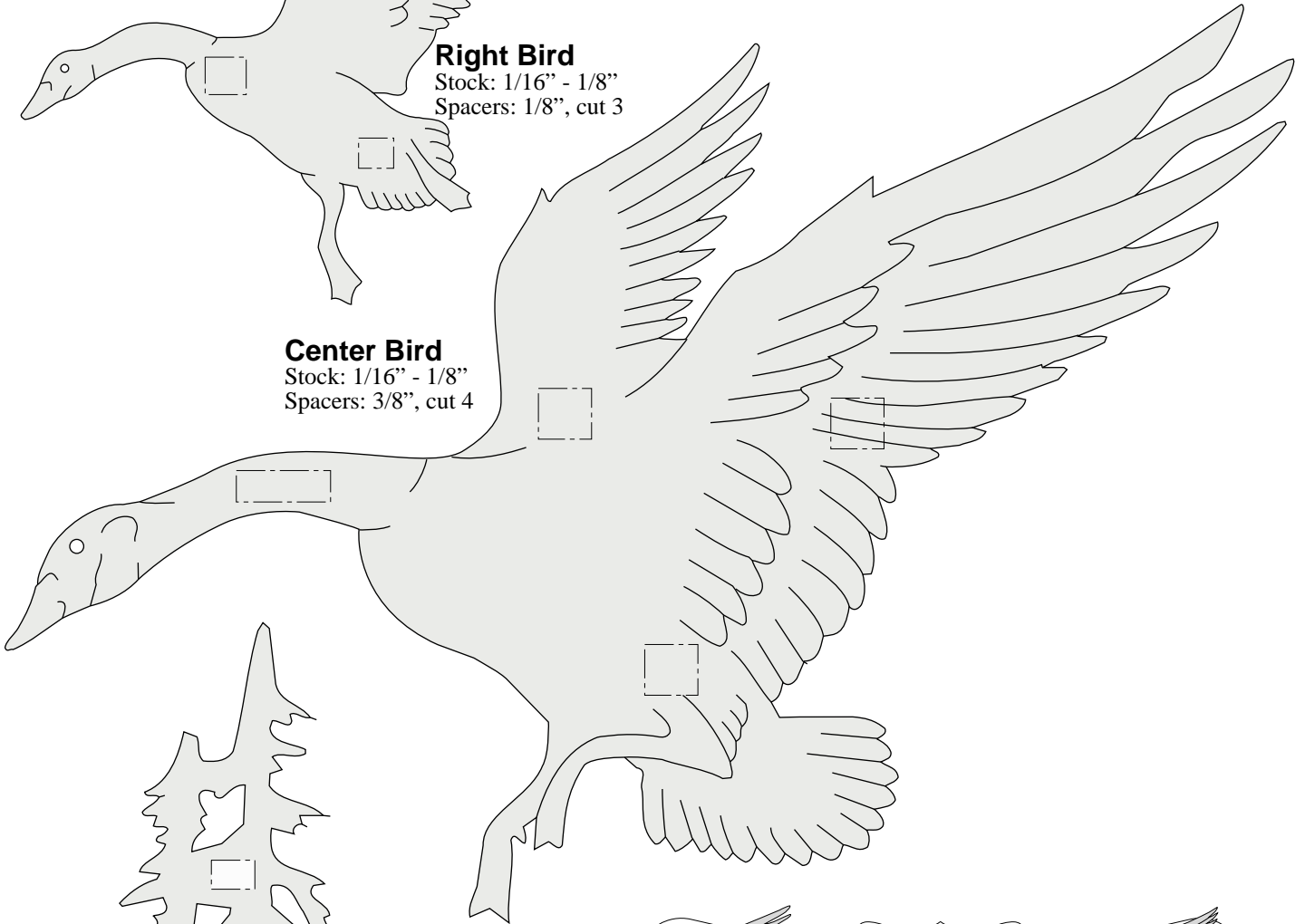

**Center Bird**  
Stock: 1/16" - 1/8"  
Spacers: 3/8", cut 4

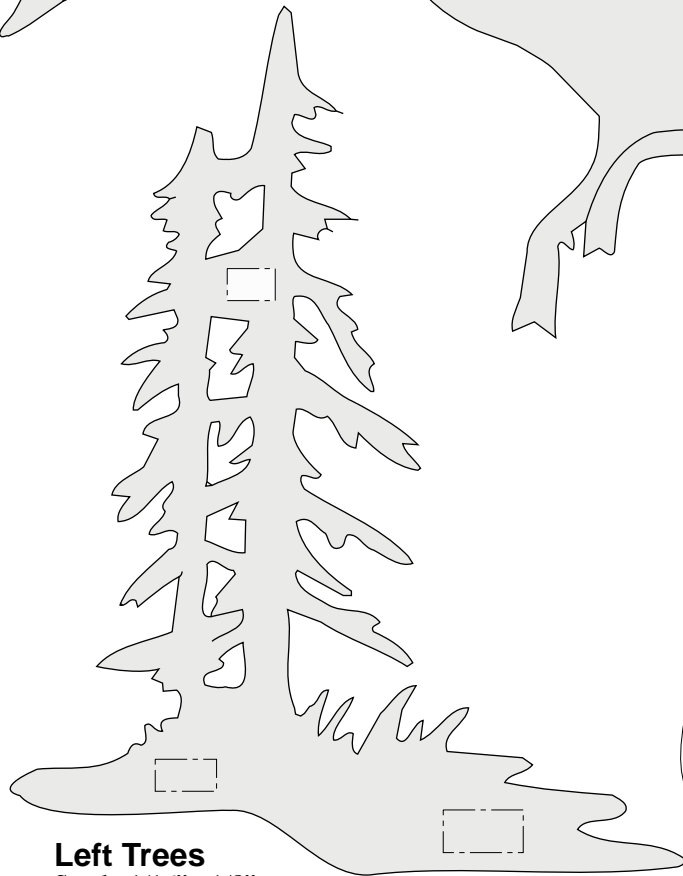

**Left Trees**  
Stock: 1/16" - 1/8"  
Spacers: 1/8", cut 3

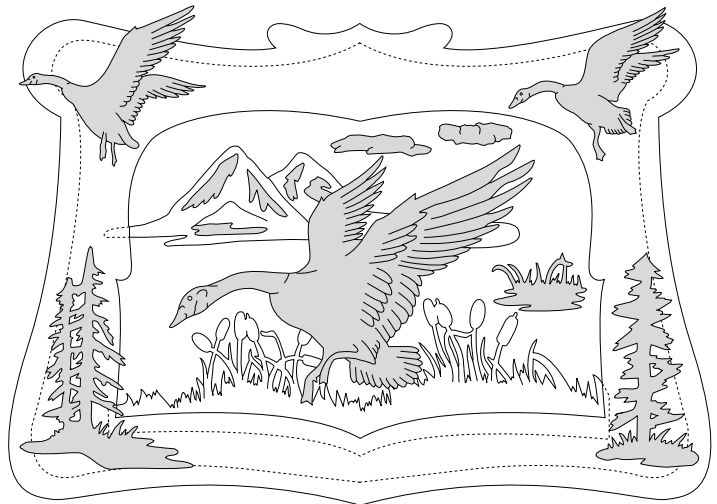

**Canadian Goose**

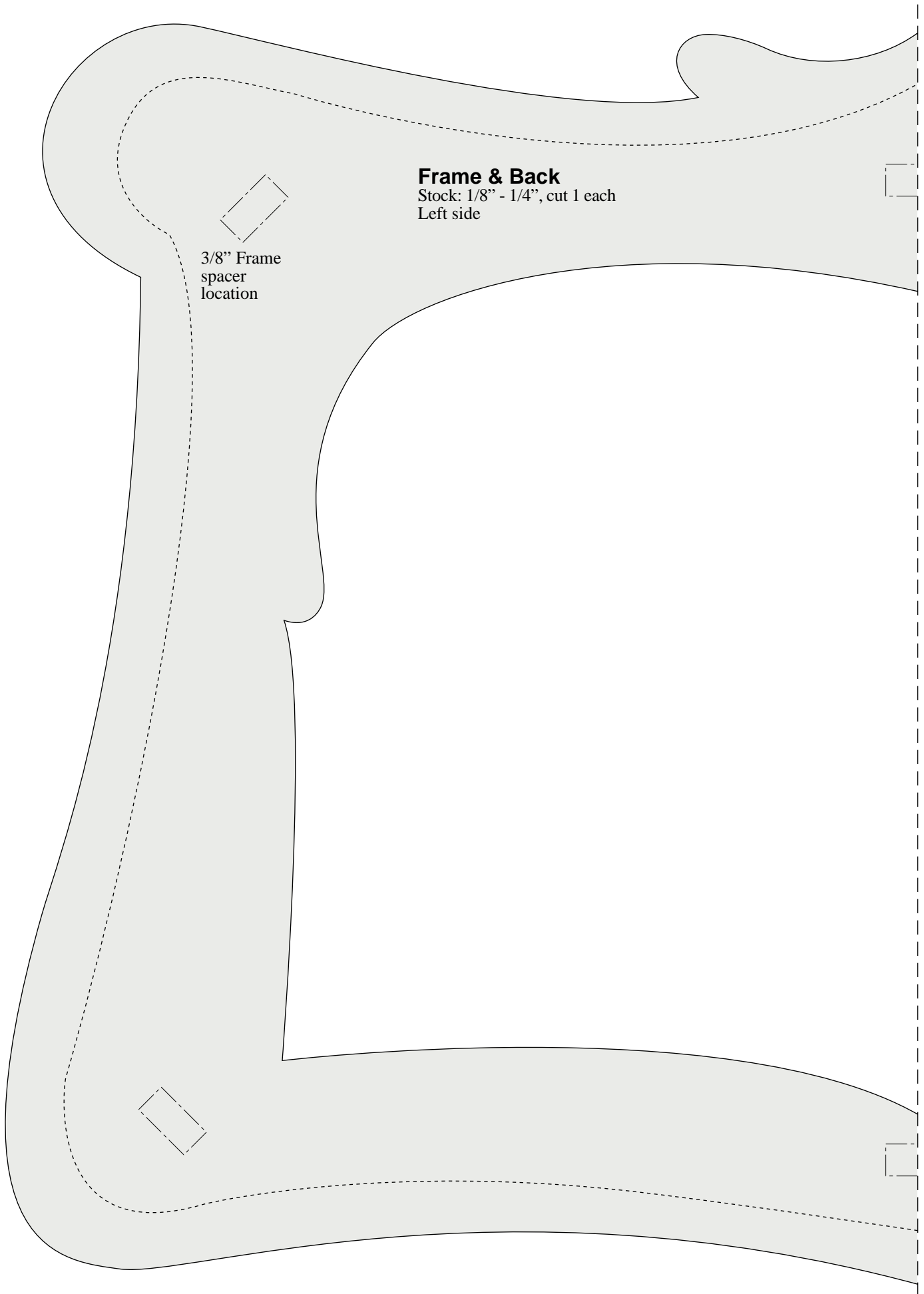

**Frame & Back**

Stock: 1/8" - 1/4", cut 1 each

Left side

3/8" Frame  
spacer  
location

Pattern overlap line

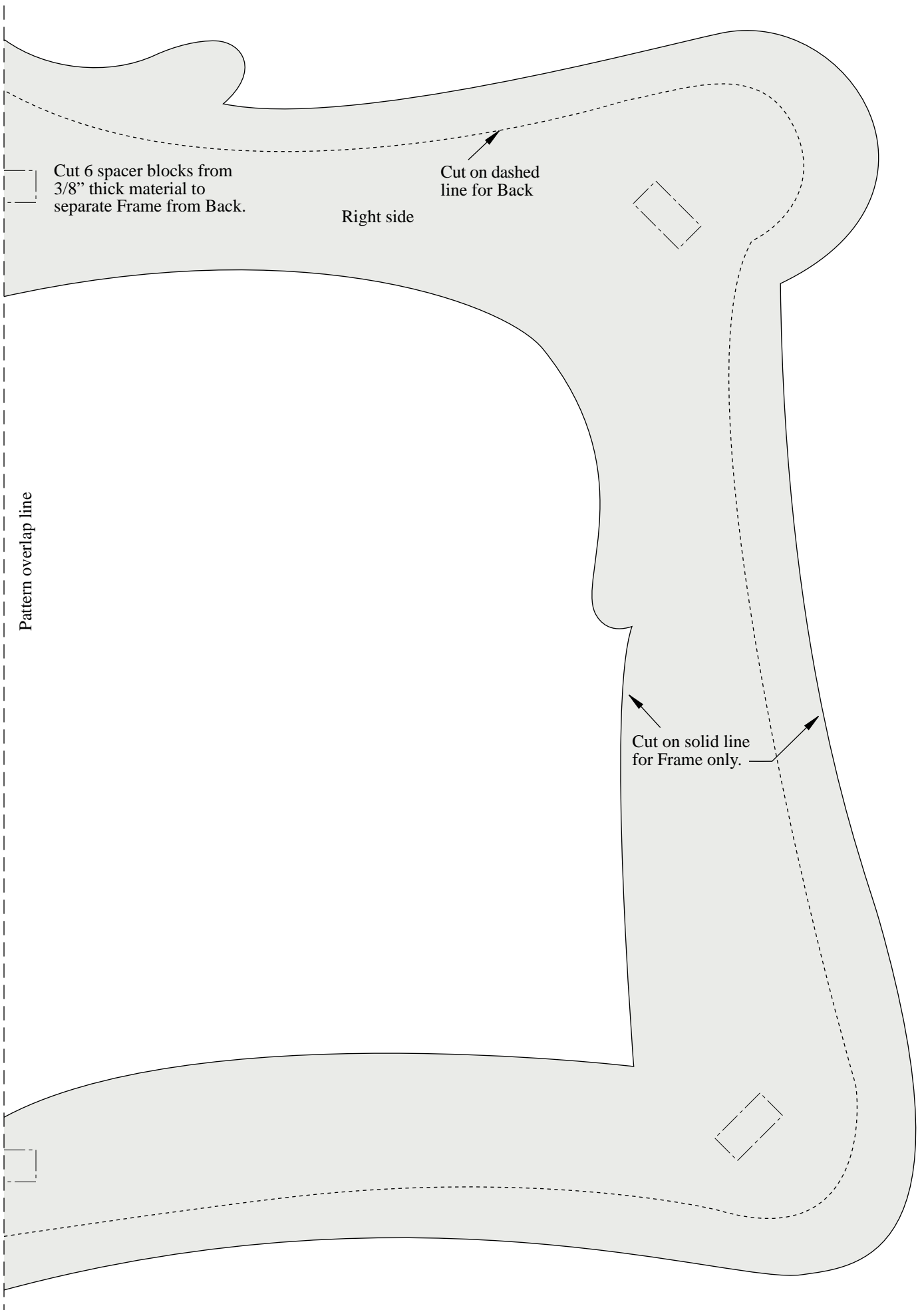

Cut 6 spacer blocks from  
3/8" thick material to  
separate Frame from Back.

Right side

Cut on dashed  
line for Back

Pattern overlap line

Cut on solid line  
for Frame only.



**Top Left Bird**  
Stock: 1/16" - 1/8"  
Spacers: 1/8", cut 3

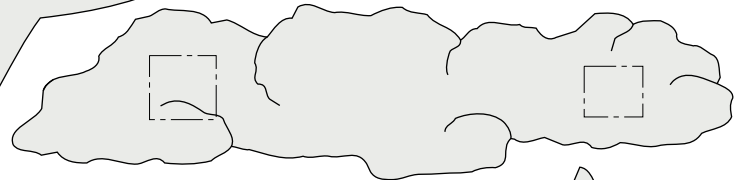

**Cloud**  
Stock: 1/16" - 1/8"  
Spacers: 1/8", cut 2

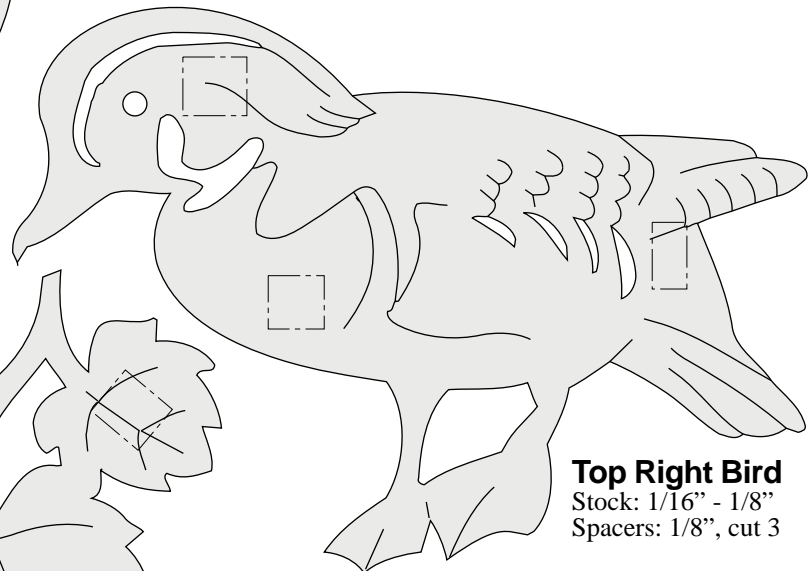

**Top Right Bird**  
Stock: 1/16" - 1/8"  
Spacers: 1/8", cut 3



**Leaves**  
Stock: 1/16" - 1/8", cut 2  
Spacers: 1/8, cut 6

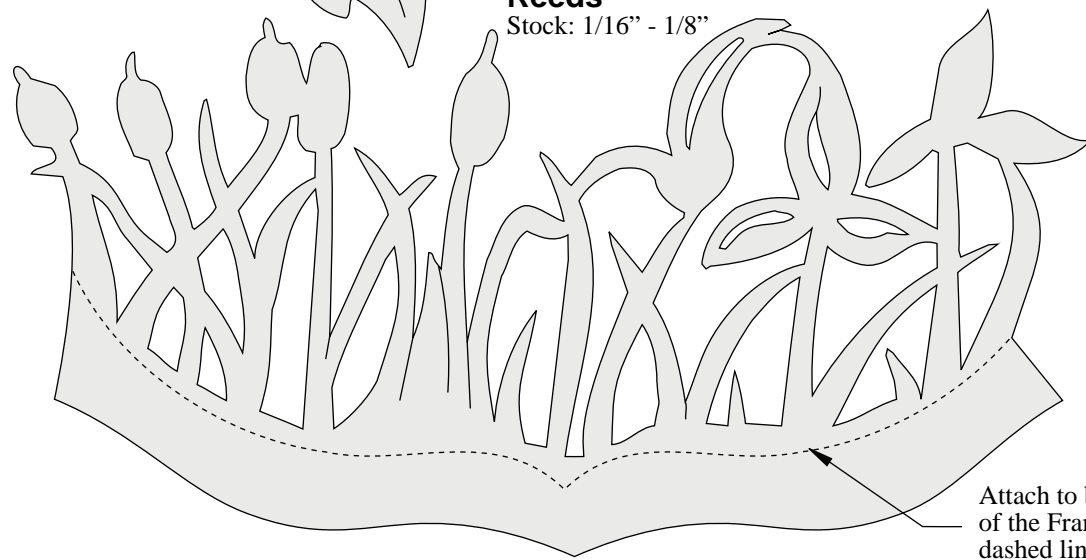

**Reeds**  
Stock: 1/16" - 1/8"

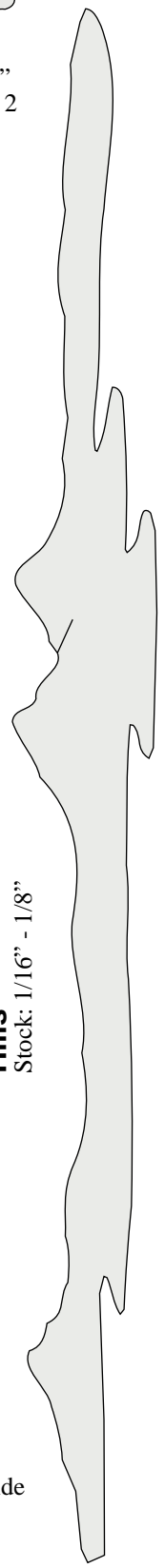

**Hills**  
Stock: 1/16" - 1/8"

Attach to backside of the Frame on dashed line.

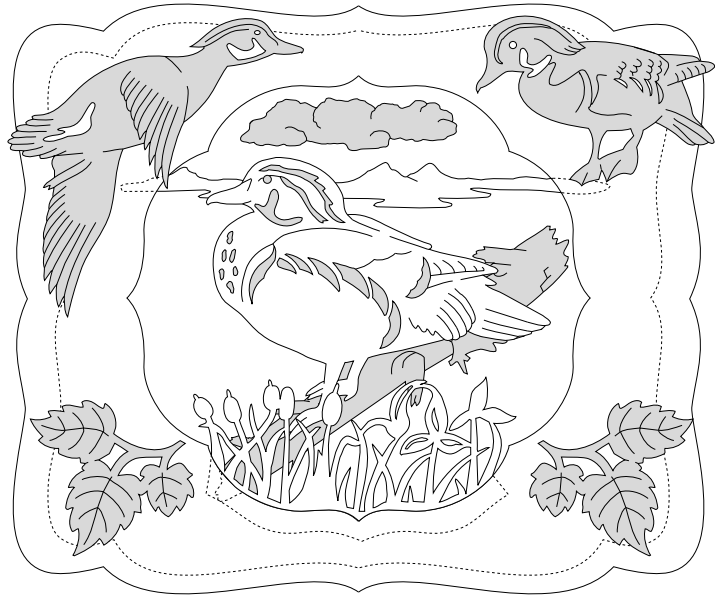

**Wood Duck**

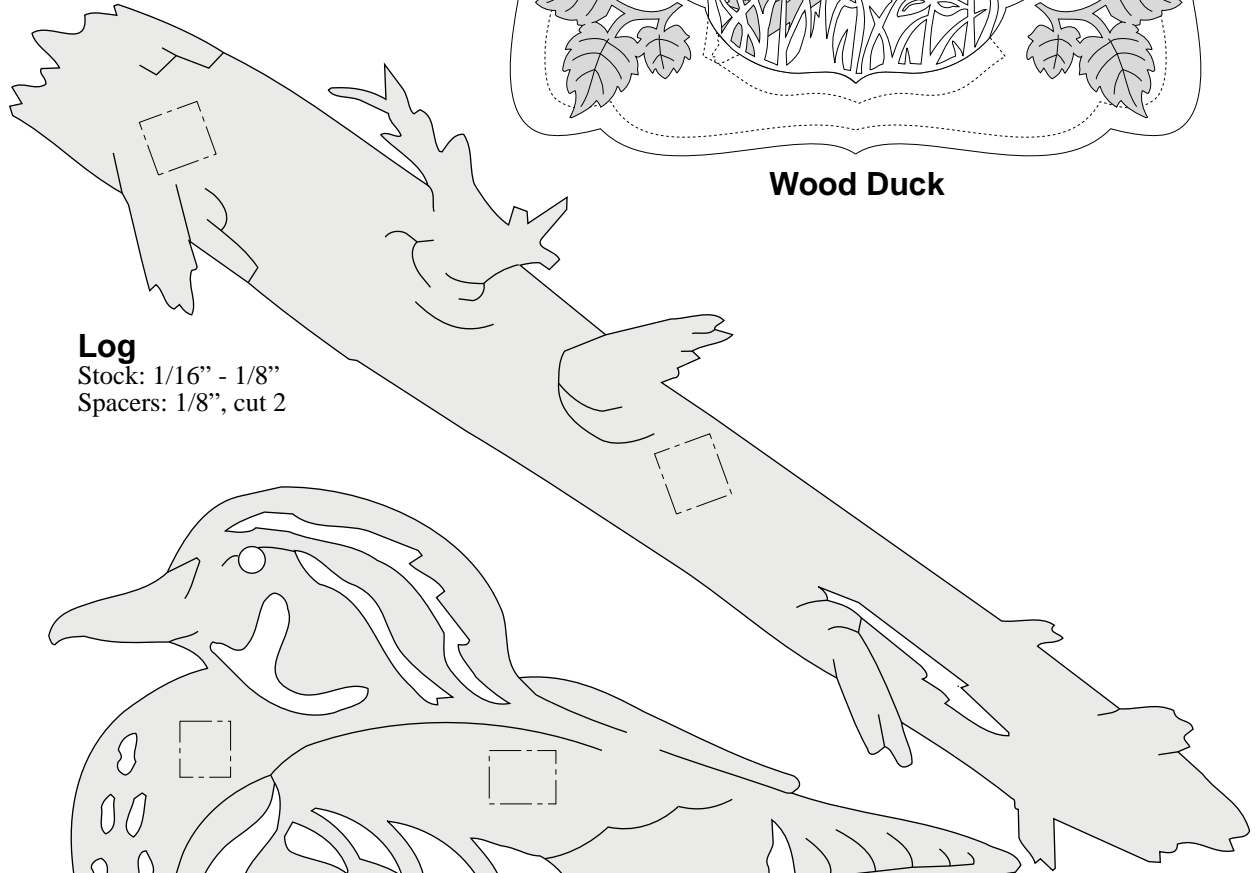

**Log**  
Stock: 1/16" - 1/8"  
Spacers: 1/8", cut 2

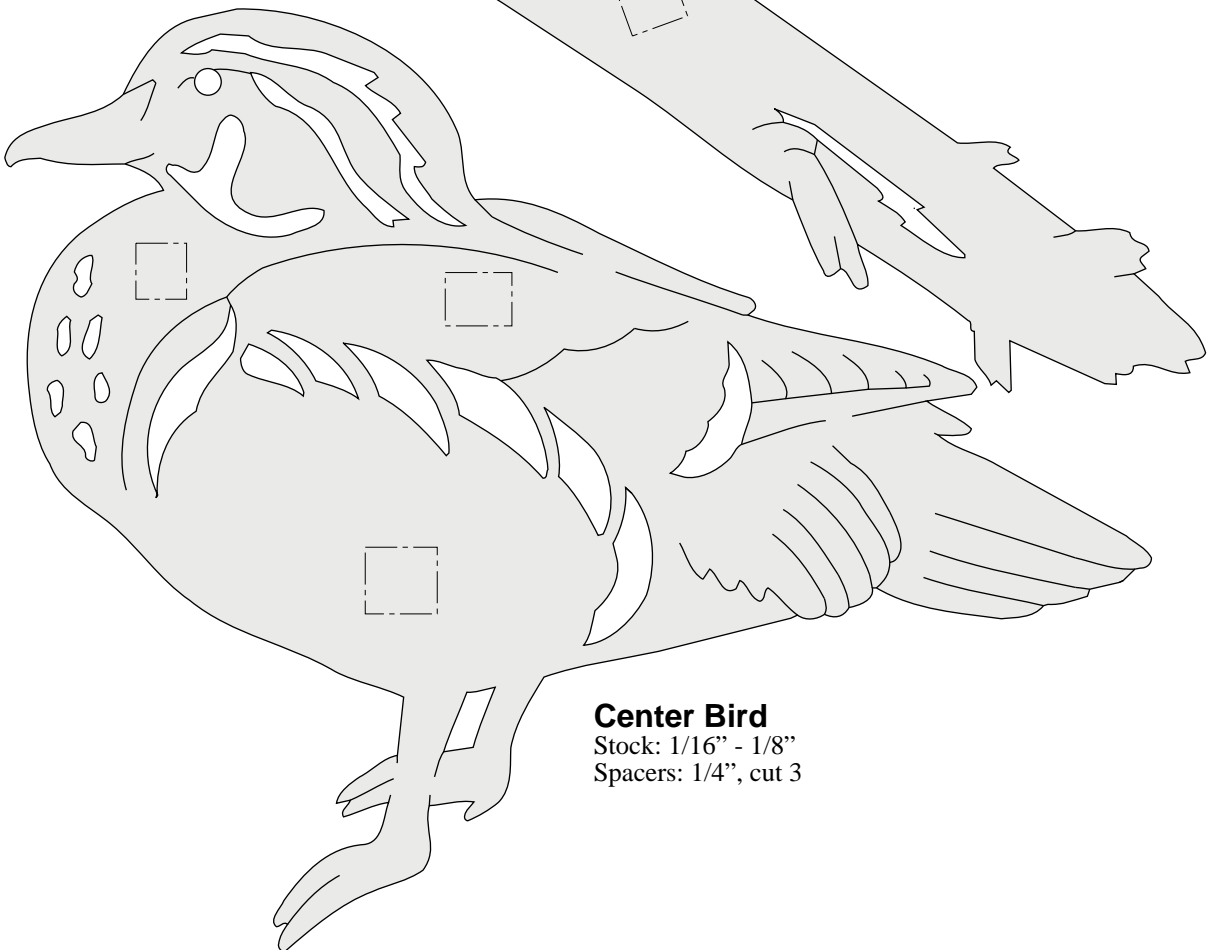

**Center Bird**  
Stock: 1/16" - 1/8"  
Spacers: 1/4", cut 3

**Frame & Back**

Stock: 1/8" - 1/4", cut 1 each  
Left side

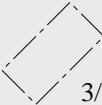

3/8" Frame  
spacer  
location

Pattern overlap line

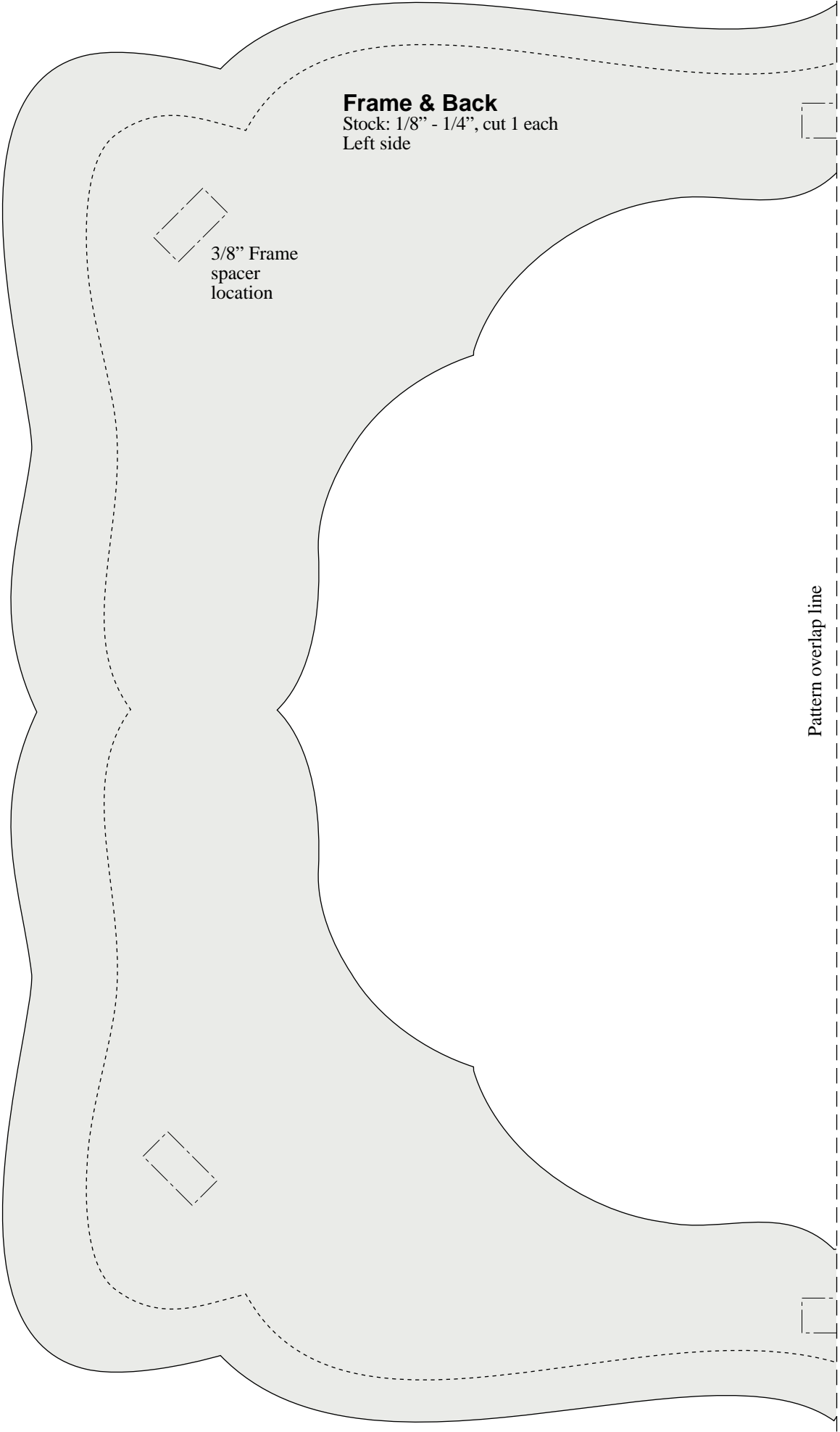



Pattern overlap line

Cut 6 spacer blocks from  
3/8" thick material to  
separate Frame from Back.

Right side

Cut on dashed line  
for Back

Cut on solid line for  
Frame only.

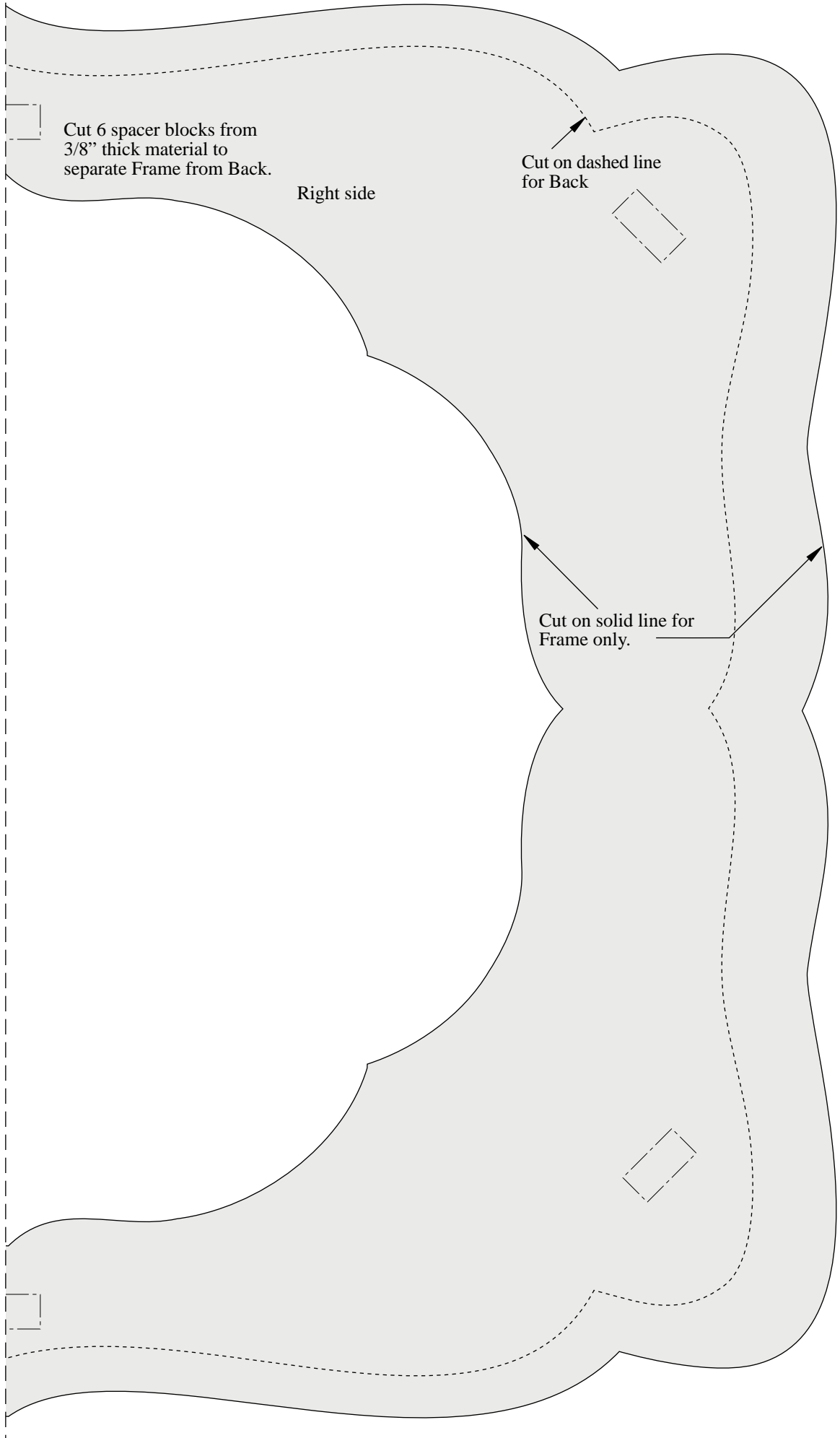

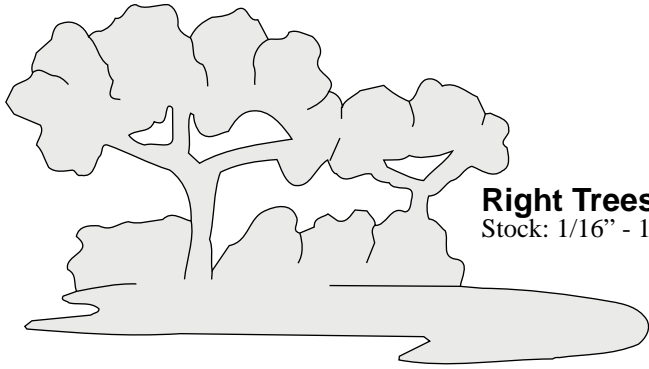

**Right Trees**  
Stock: 1/16" - 1/8"

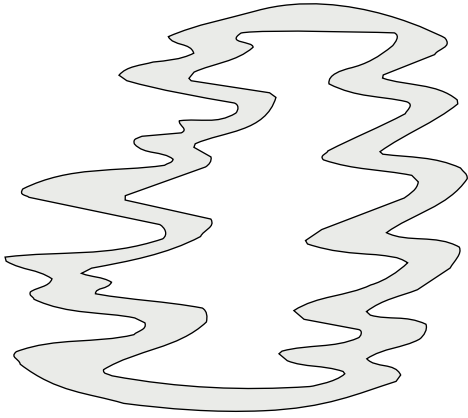

**Right Water**  
Stock: 1/16" - 1/8"

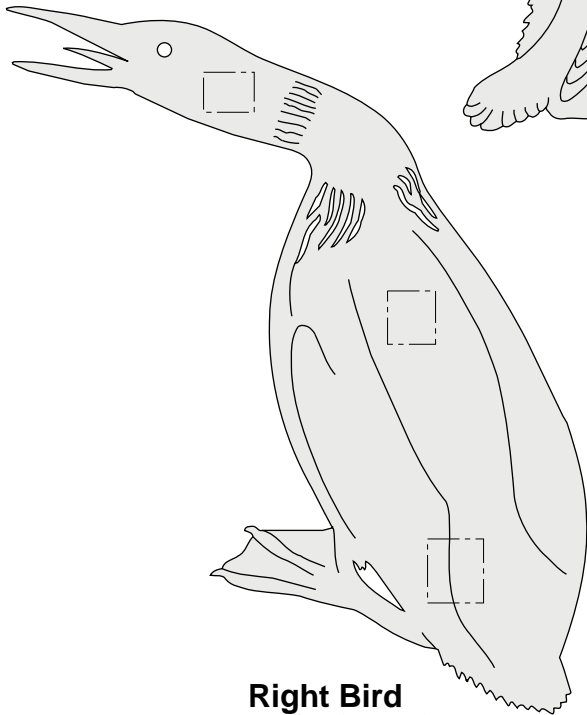

**Right Bird**  
Stock: 1/16" - 1/8"  
Spacers: 1/8", cut 3

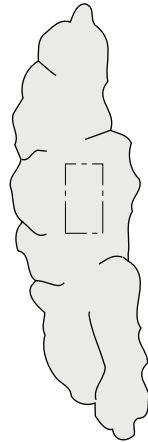

**Right Cloud**  
Stock: 1/16" - 1/8"  
Spacers: 1/8"

**Grass**  
Stock: 1/16" - 1/8"

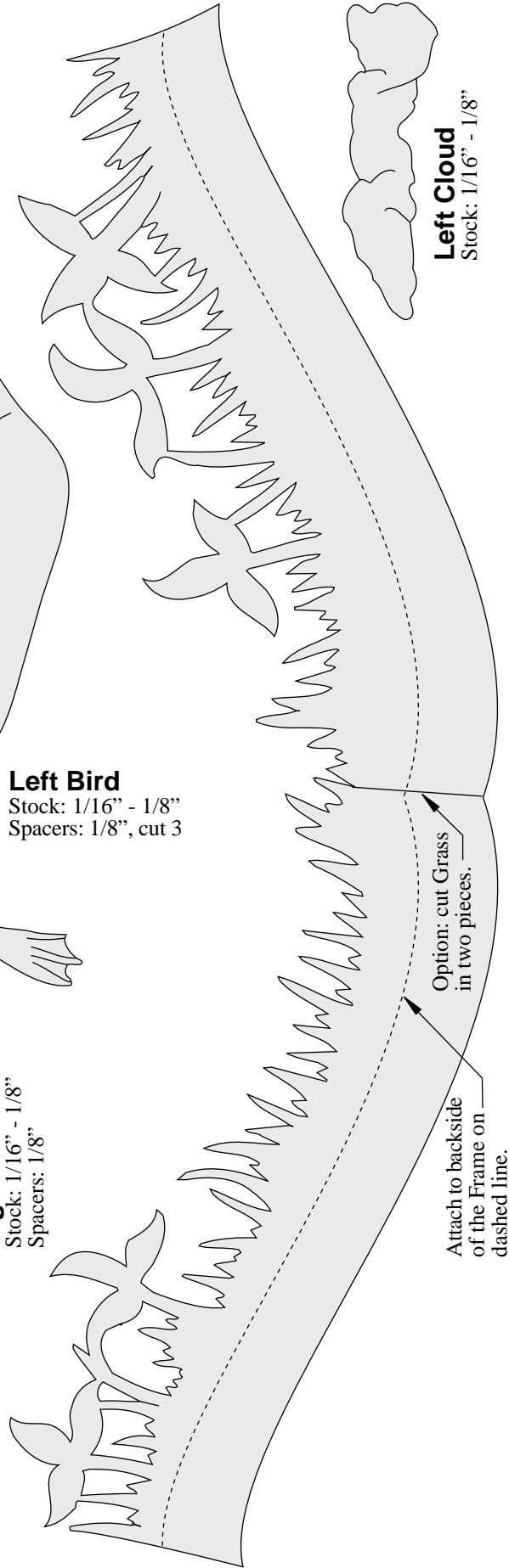

**Left Cloud**  
Stock: 1/16" - 1/8"

**Left Bird**  
Stock: 1/16" - 1/8"  
Spacers: 1/8", cut 3

**Left Water**  
Stock: 1/16" - 1/8"

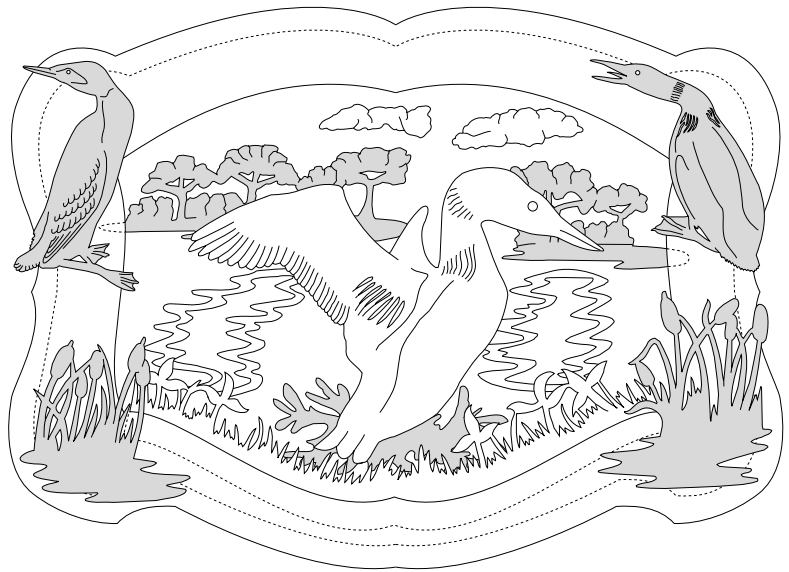

**Common Loon**

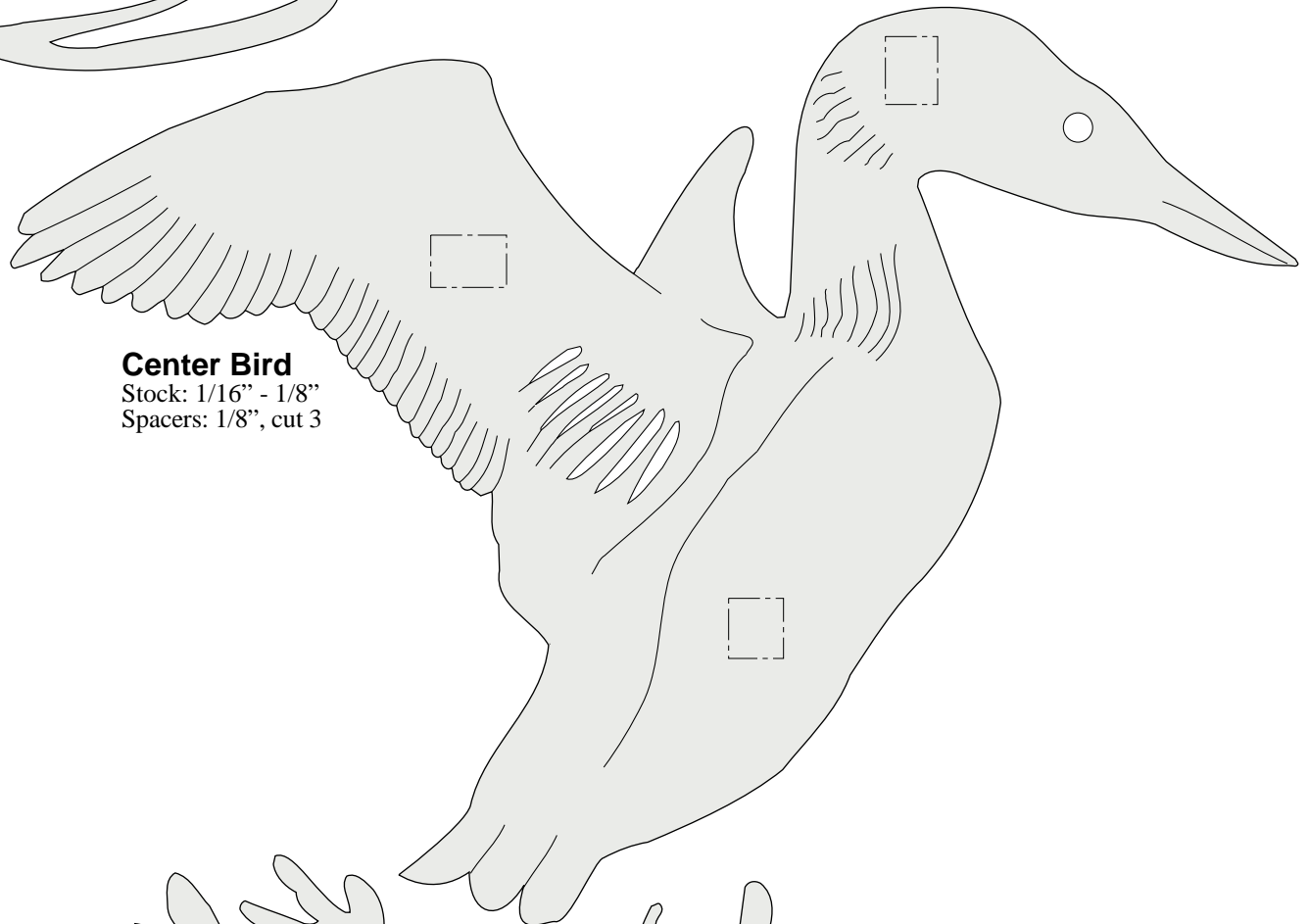

**Center Bird**  
Stock: 1/16" - 1/8"  
Spacers: 1/8", cut 3

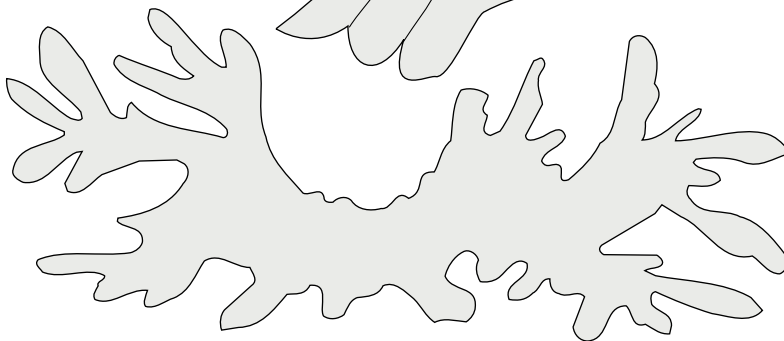

**Splash**  
Stock: 1/16" - 1/8"

**Frame & Back**

Stock: 1/8" - 1/4", cut 1 each  
Left Side

3/8" Frame  
spacer  
location

**Left Trees**

Stock: 1/16" - 1/8"

**Left Cattails**

Stock: 1/16" - 1/8"  
Spacers: 1/8", cut 3

Pattern overlap line

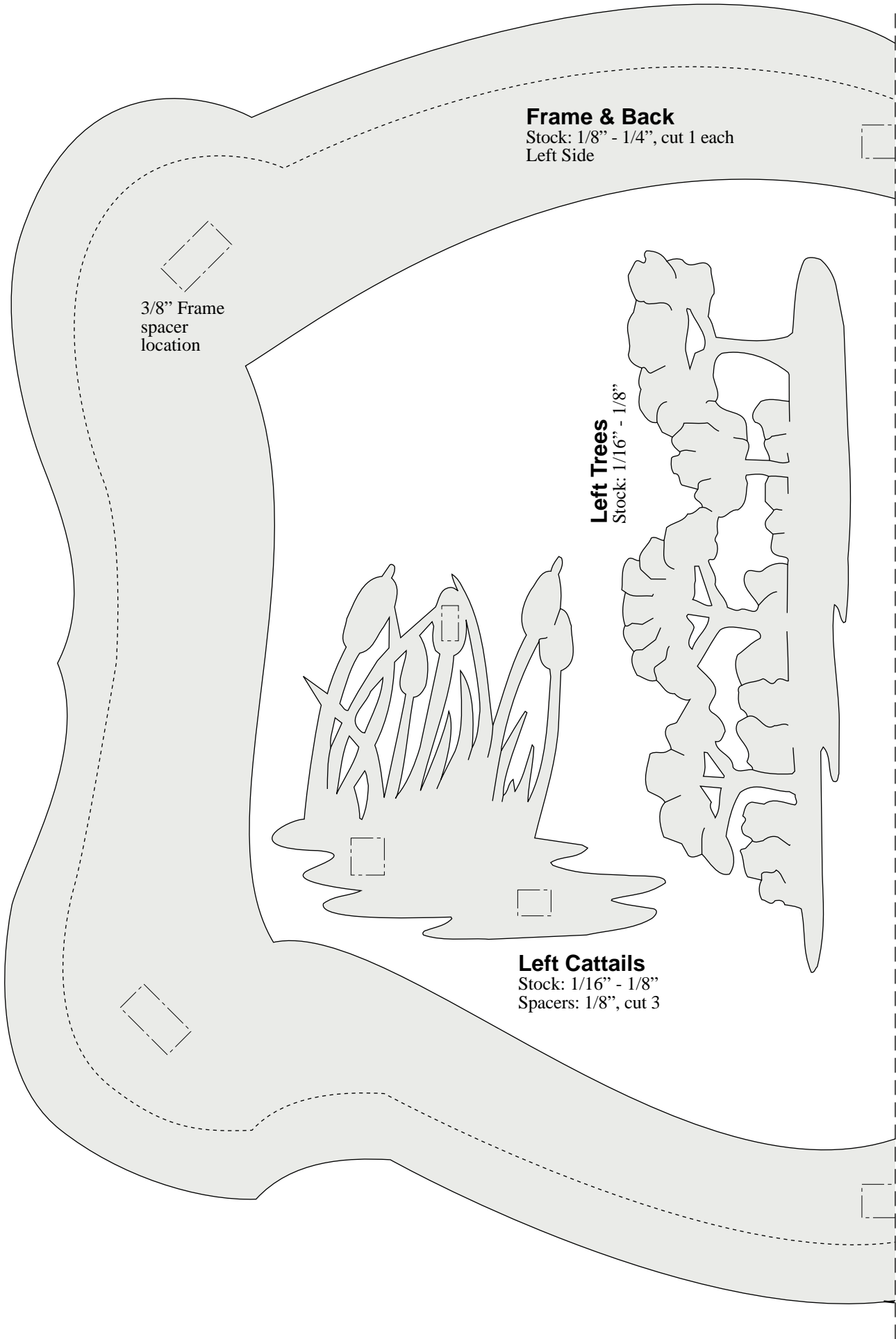

Pattern overlap line

Cut 6 spacer blocks from  
3/8" thick material to  
separate Frame from Back.

Right side

Cut on dashed line  
for Back

Cut on solid line  
for Frame only.

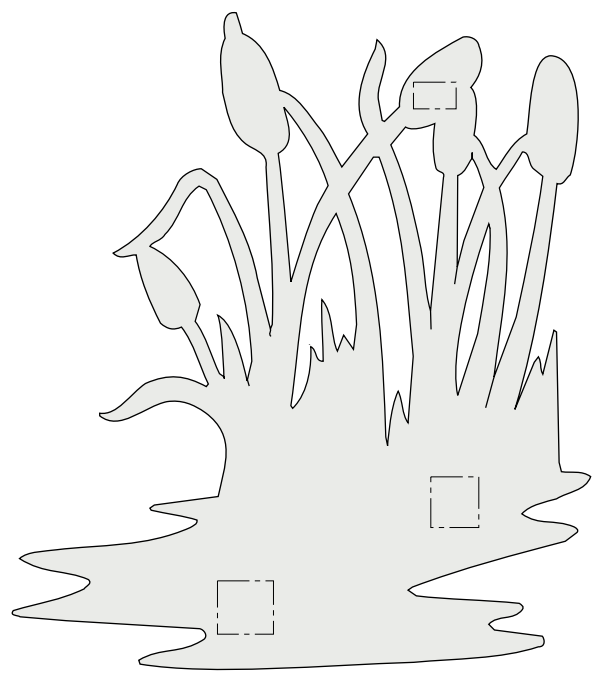

**Right Cattails**

Stock: 1/16" - 1/8"

Spacers: 1/8", cut 3

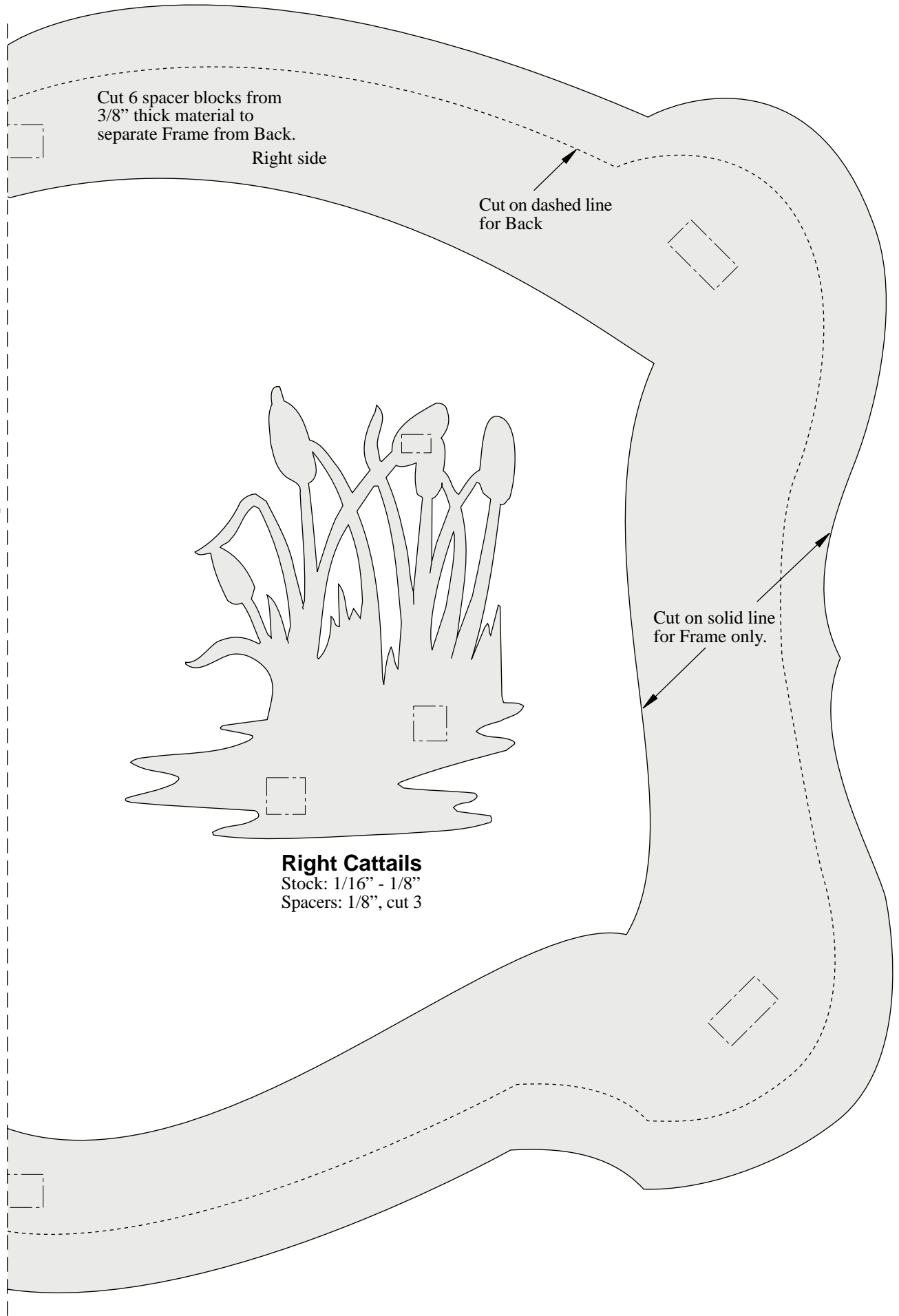

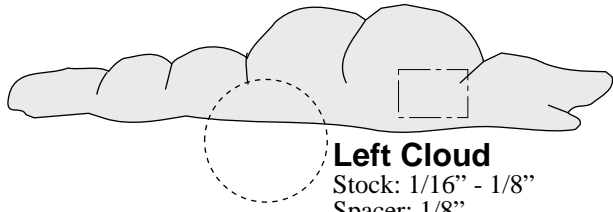

**Left Cloud**  
Stock: 1/16" - 1/8"  
Spacer: 1/8"

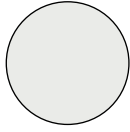

**Sun**  
Stock: 1/16" - 1/8"

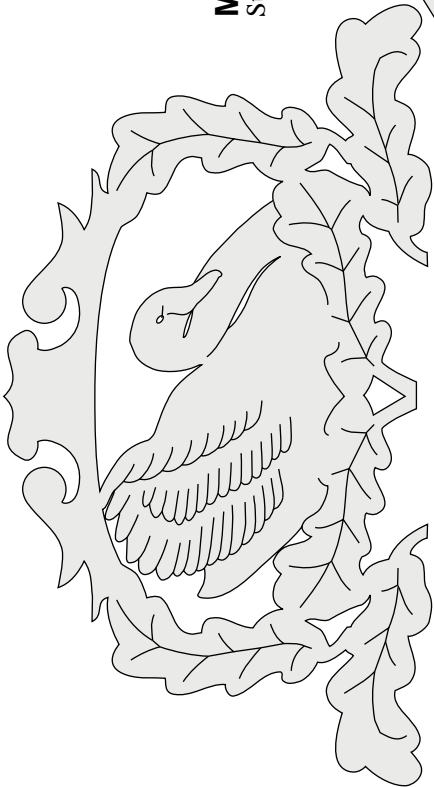

**Bottom Overlay**  
Stock: 1/16" - 1/8"

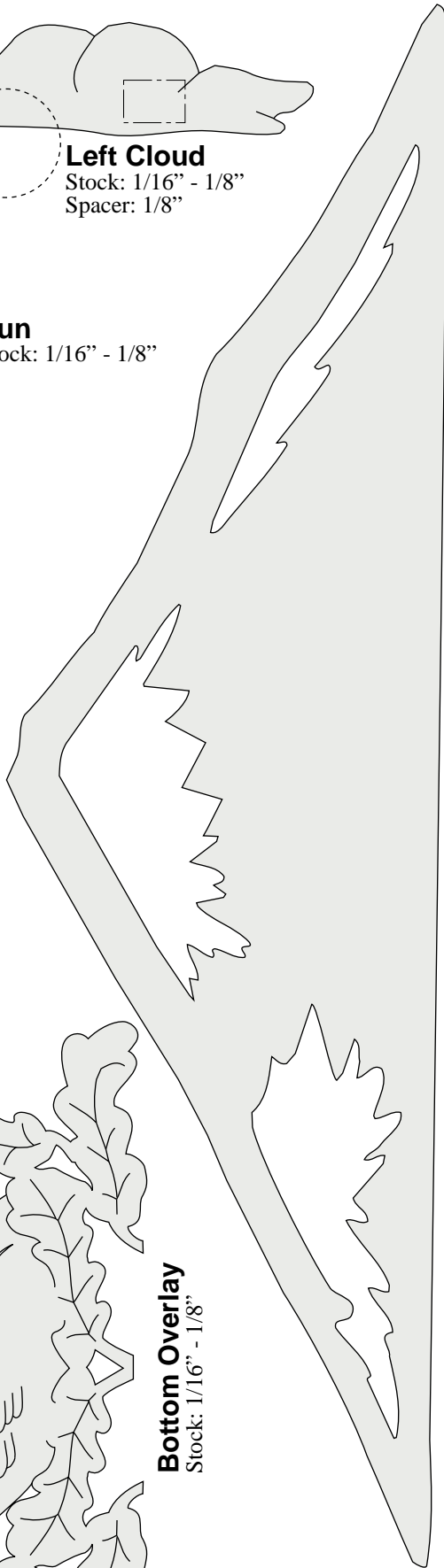

**Mountain**  
Stock: 1/16" - 1/8"

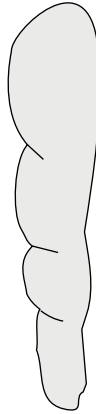

**Right Cloud**  
Stock: 1/16" - 1/8"

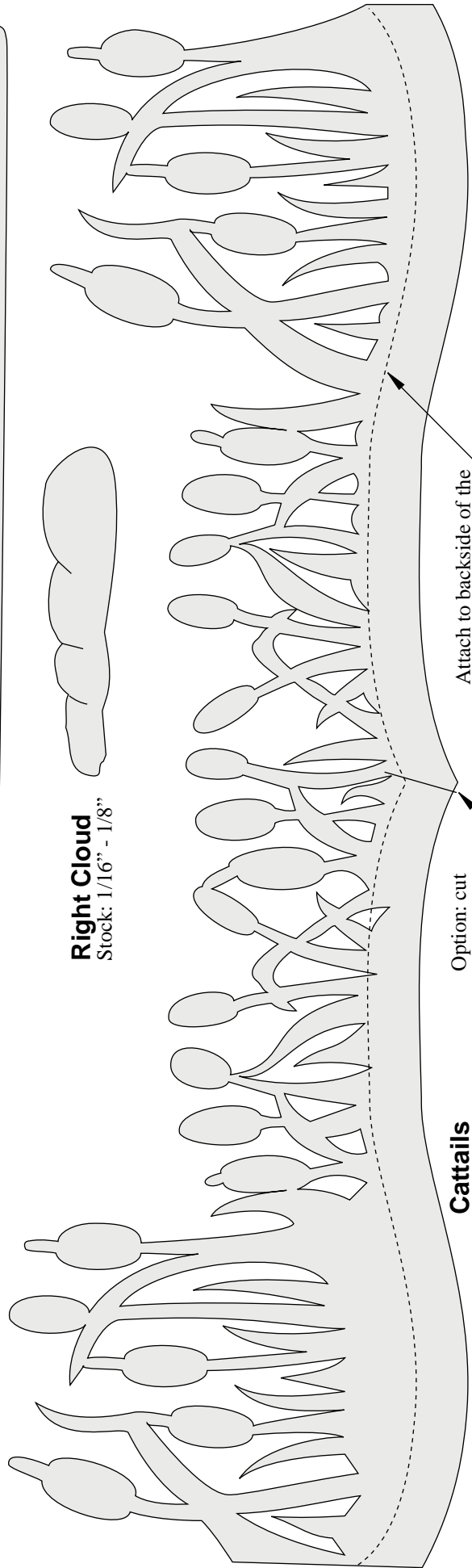

Attach to backside of the  
Frame on dashed line.

Option: cut  
Cattails in two  
pieces.

**Cattails**  
Stock: 1/16" - 1/8"

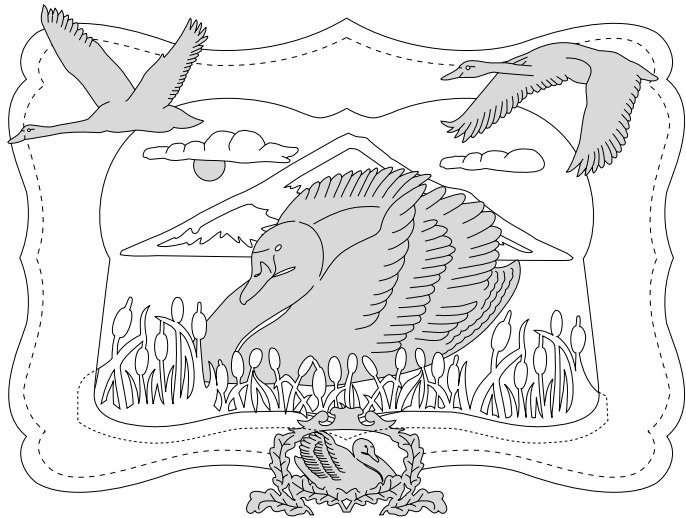

Swan

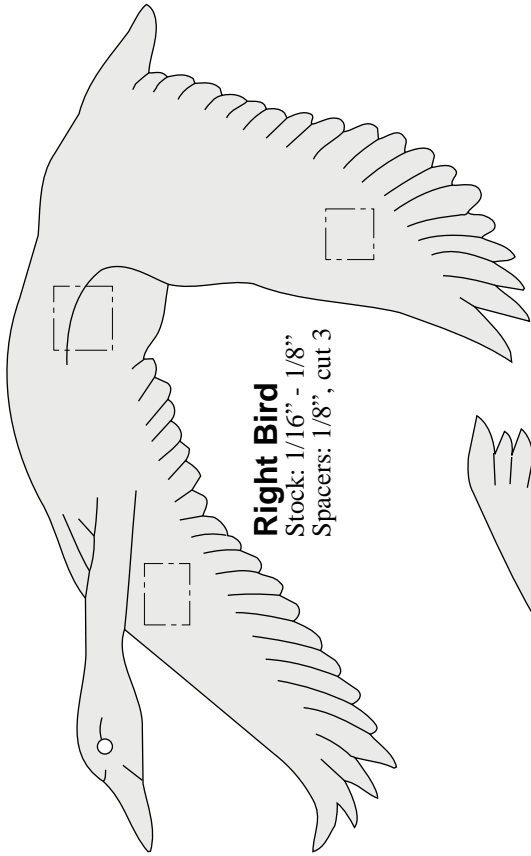

**Right Bird**

Stock: 1/16" - 1/8"  
Spacers: 1/8", cut 3

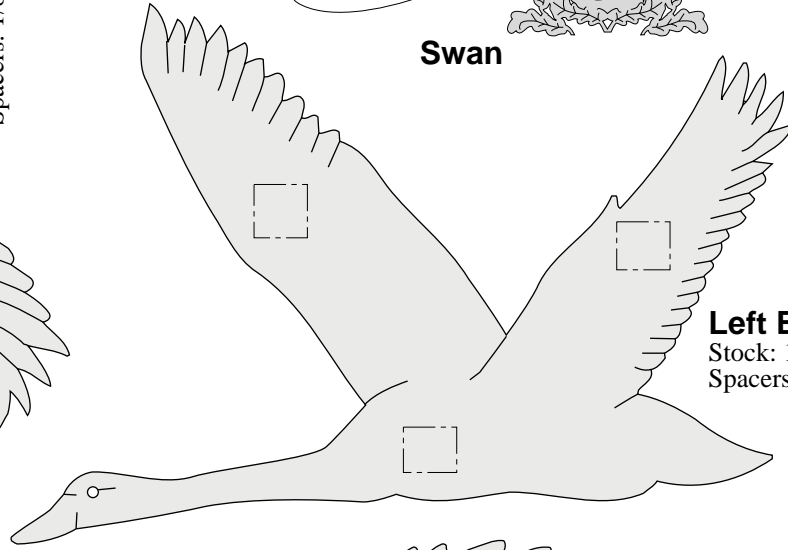

**Left Bird**

Stock: 1/16" - 1/8"  
Spacers: 1/8", cut 3

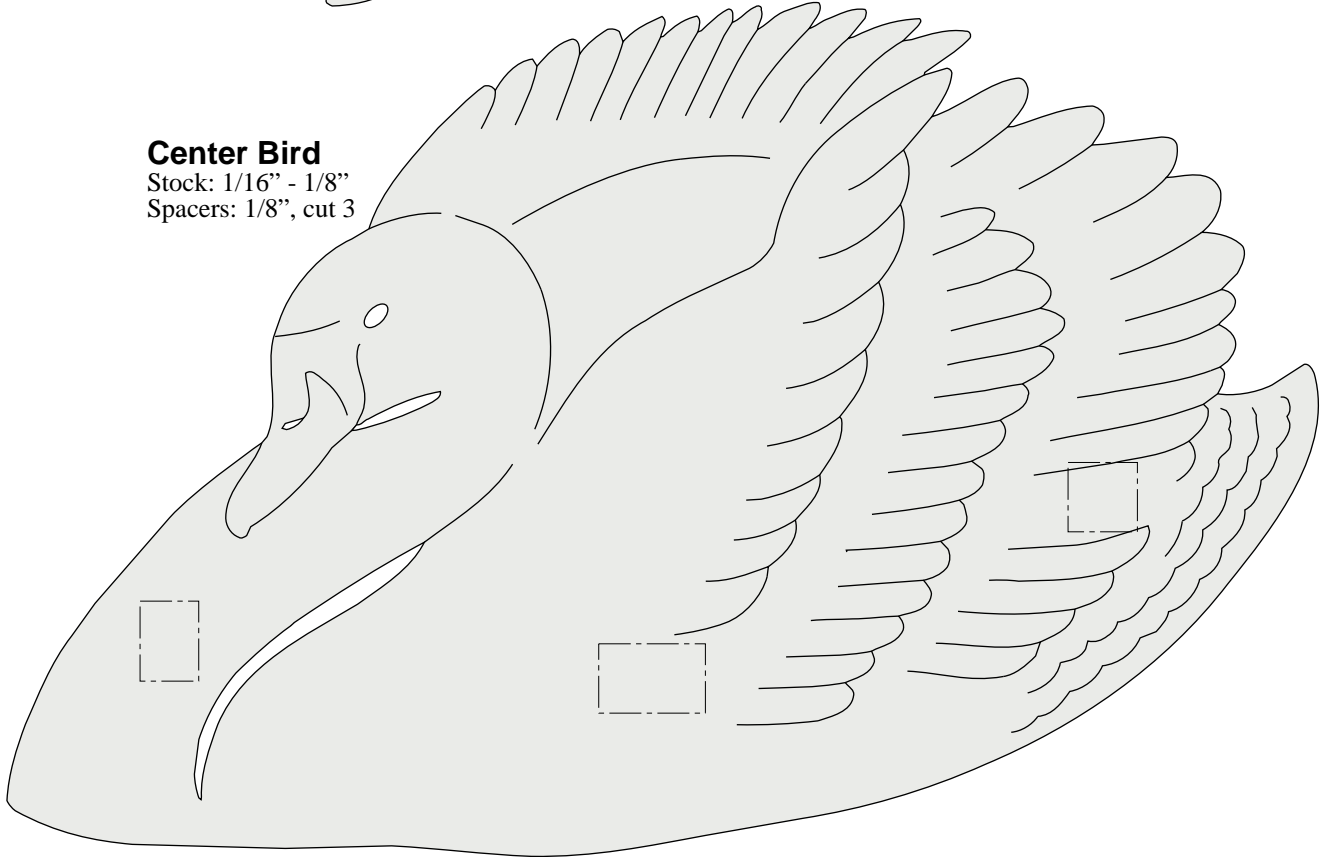

**Center Bird**

Stock: 1/16" - 1/8"  
Spacers: 1/8", cut 3

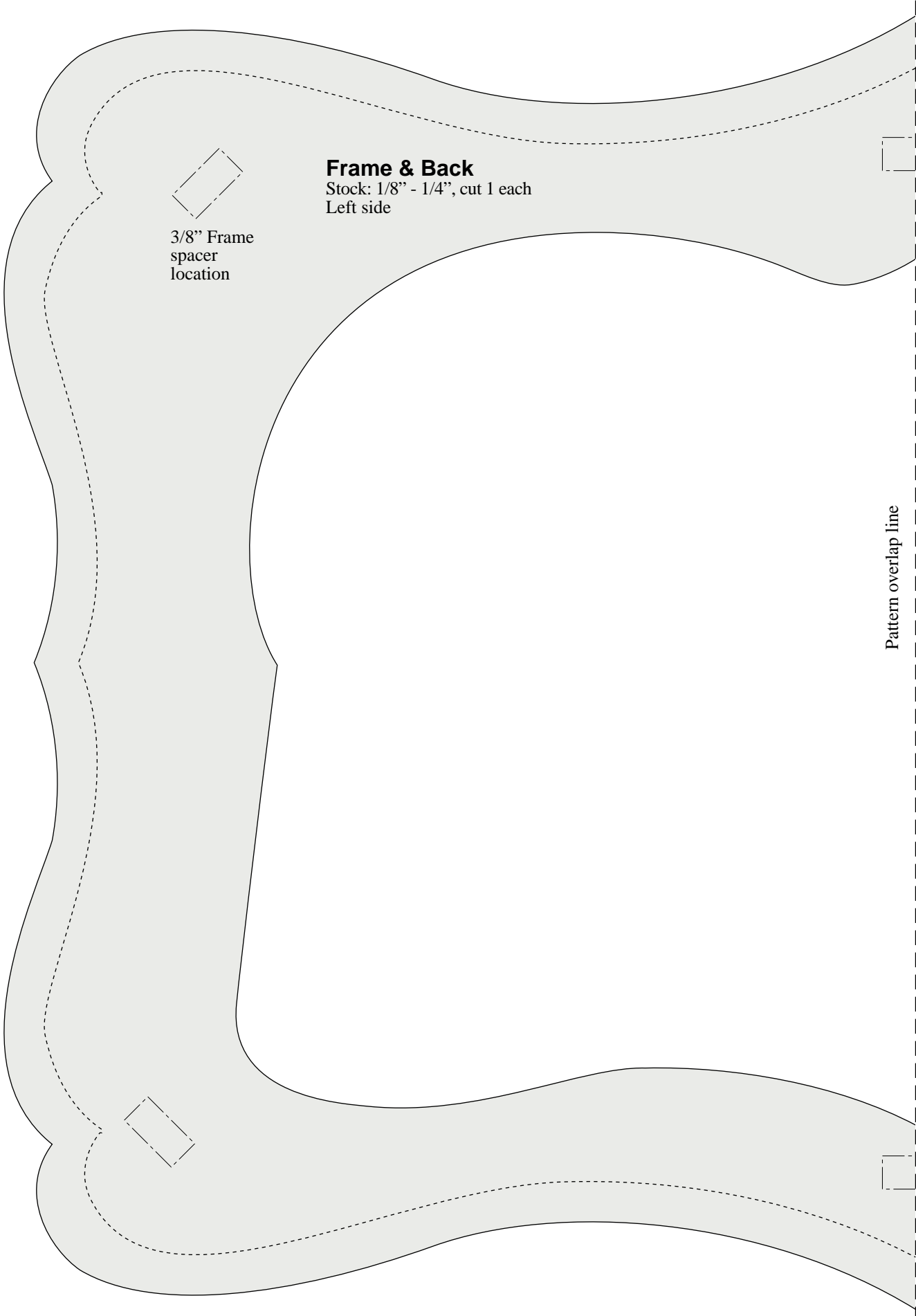

**Frame & Back**

Stock: 1/8" - 1/4", cut 1 each

Left side

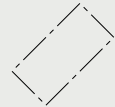

3/8" Frame  
spacer  
location

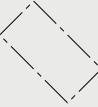

Pattern overlap line



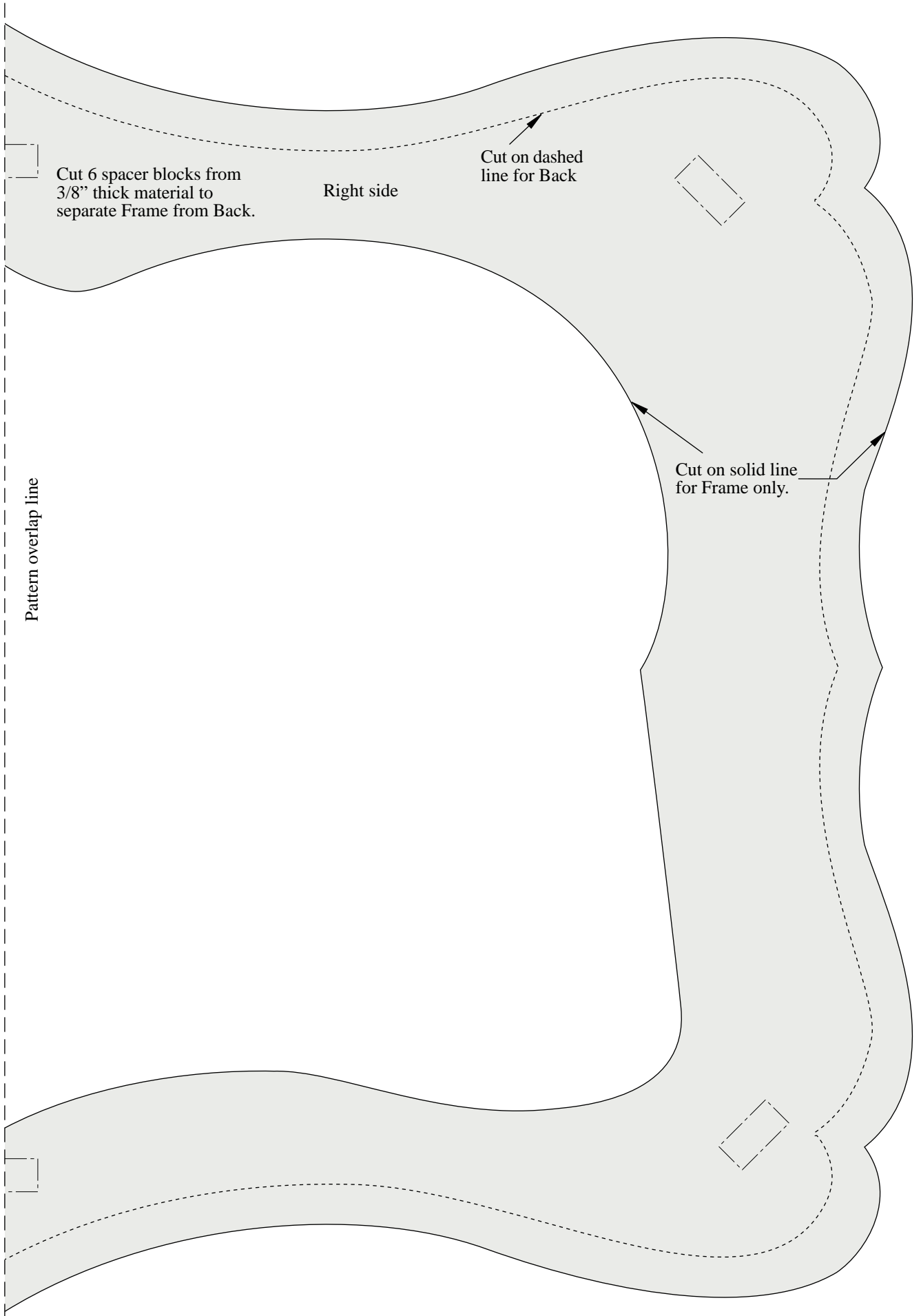

Cut 6 spacer blocks from  
3/8'' thick material to  
separate Frame from Back.

Right side

Cut on dashed  
line for Back

Cut on solid line  
for Frame only.

Pattern overlap line

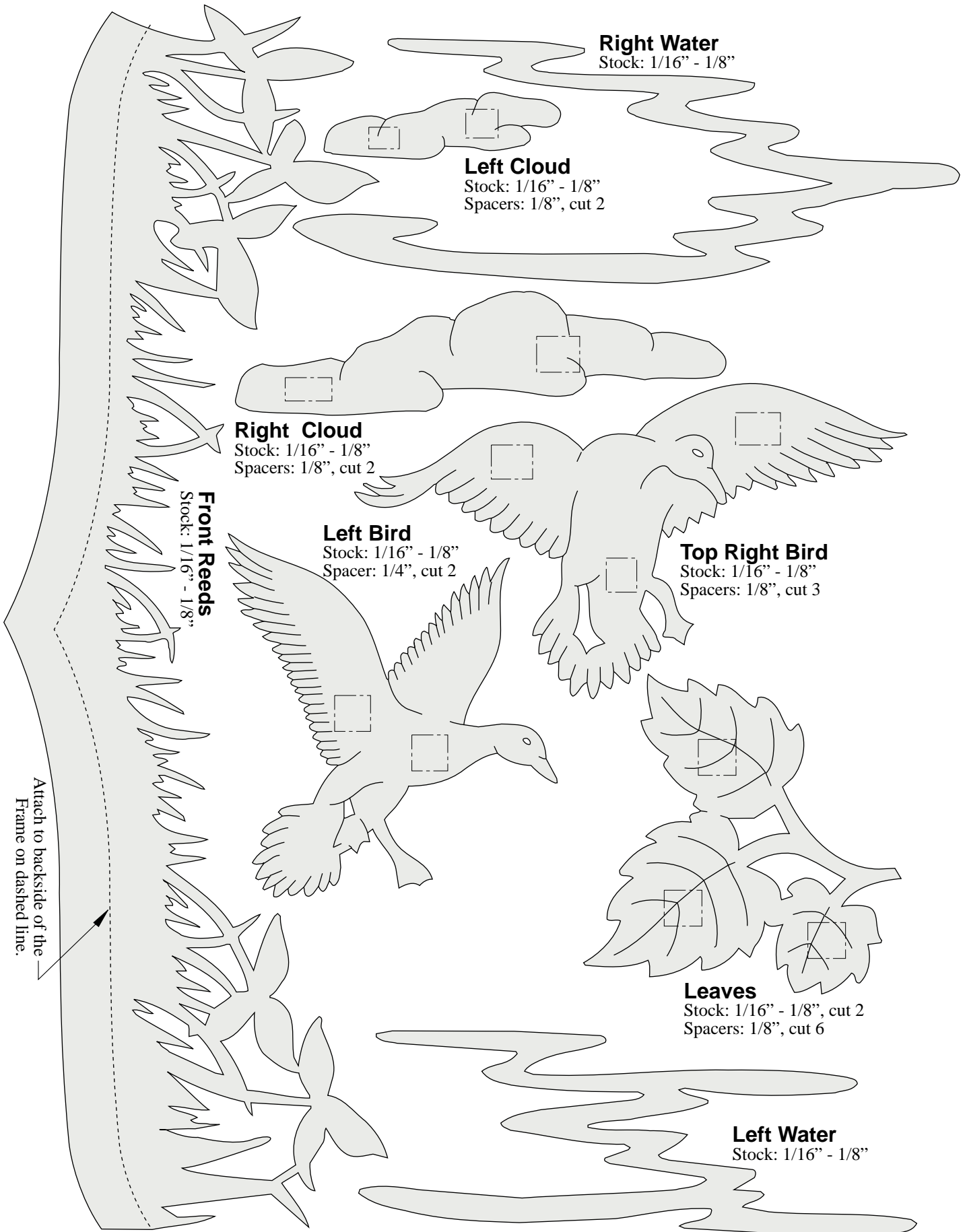

**Right Water**  
Stock: 1/16" - 1/8"

**Left Cloud**  
Stock: 1/16" - 1/8"  
Spacers: 1/8", cut 2

**Right Cloud**  
Stock: 1/16" - 1/8"  
Spacers: 1/8", cut 2

**Left Bird**  
Stock: 1/16" - 1/8"  
Spacer: 1/4", cut 2

**Top Right Bird**  
Stock: 1/16" - 1/8"  
Spacers: 1/8", cut 3

**Front Reeds**  
Stock: 1/16" - 1/8"

**Leaves**  
Stock: 1/16" - 1/8", cut 2  
Spacers: 1/8", cut 6

**Left Water**  
Stock: 1/16" - 1/8"

Attach to backside of the  
Frame on dashed line.

**Mountains**  
Stock: 1/16" - 1/8"

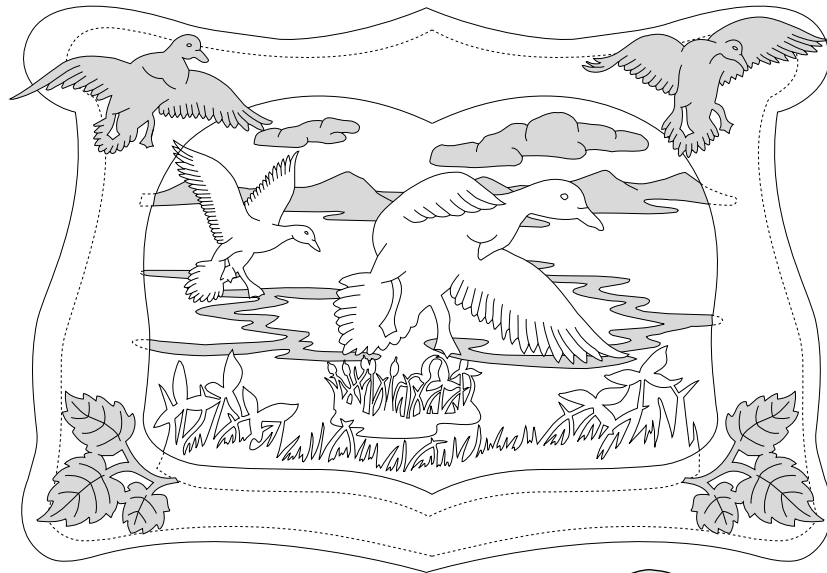
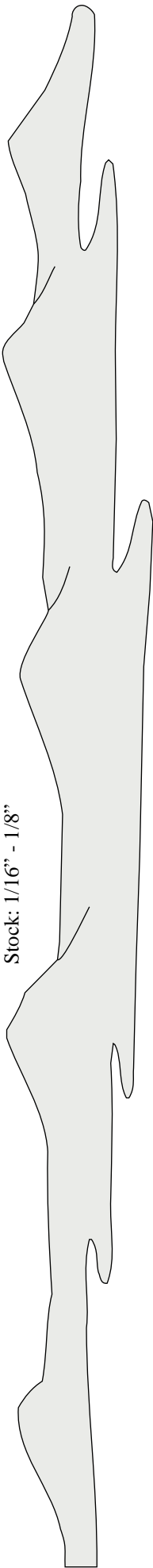

**Mallard Duck**

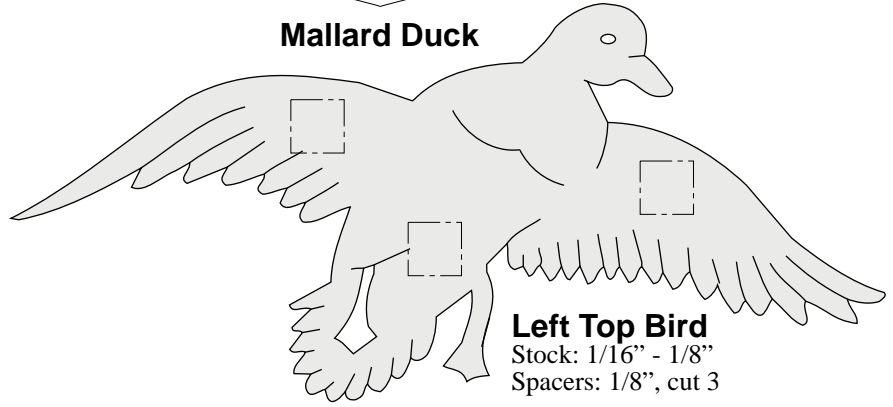

**Left Top Bird**  
Stock: 1/16" - 1/8"  
Spacers: 1/8", cut 3

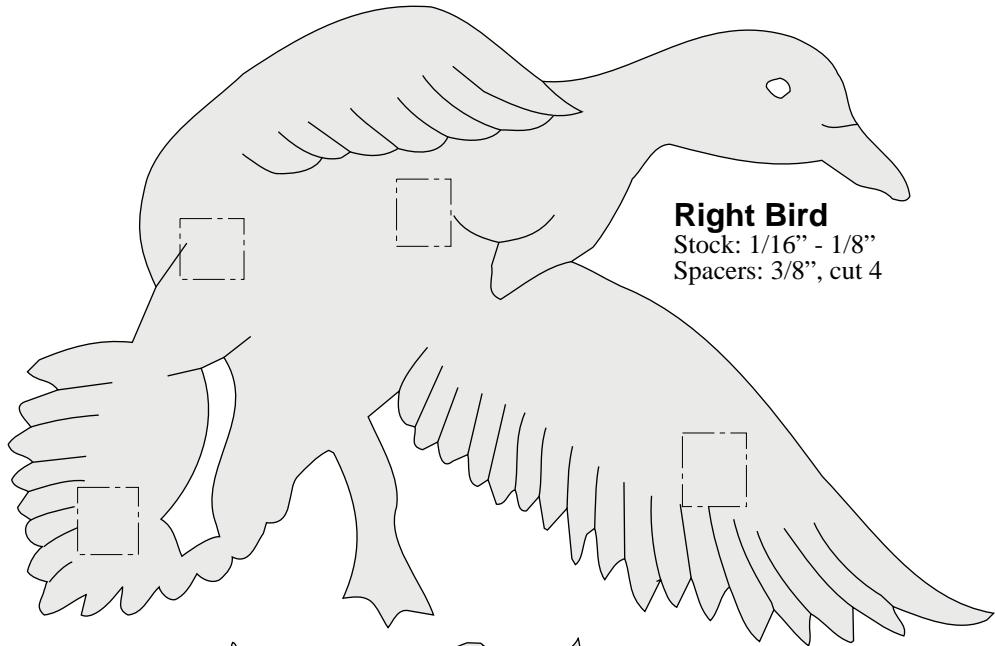

**Right Bird**  
Stock: 1/16" - 1/8"  
Spacers: 3/8", cut 4

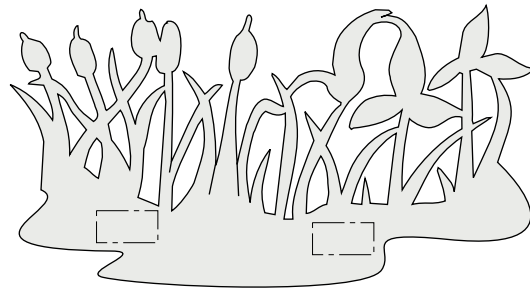

**Back Reeds**  
Stock: 1/16" - 1/8"  
Spacers: 1/8", cut 2

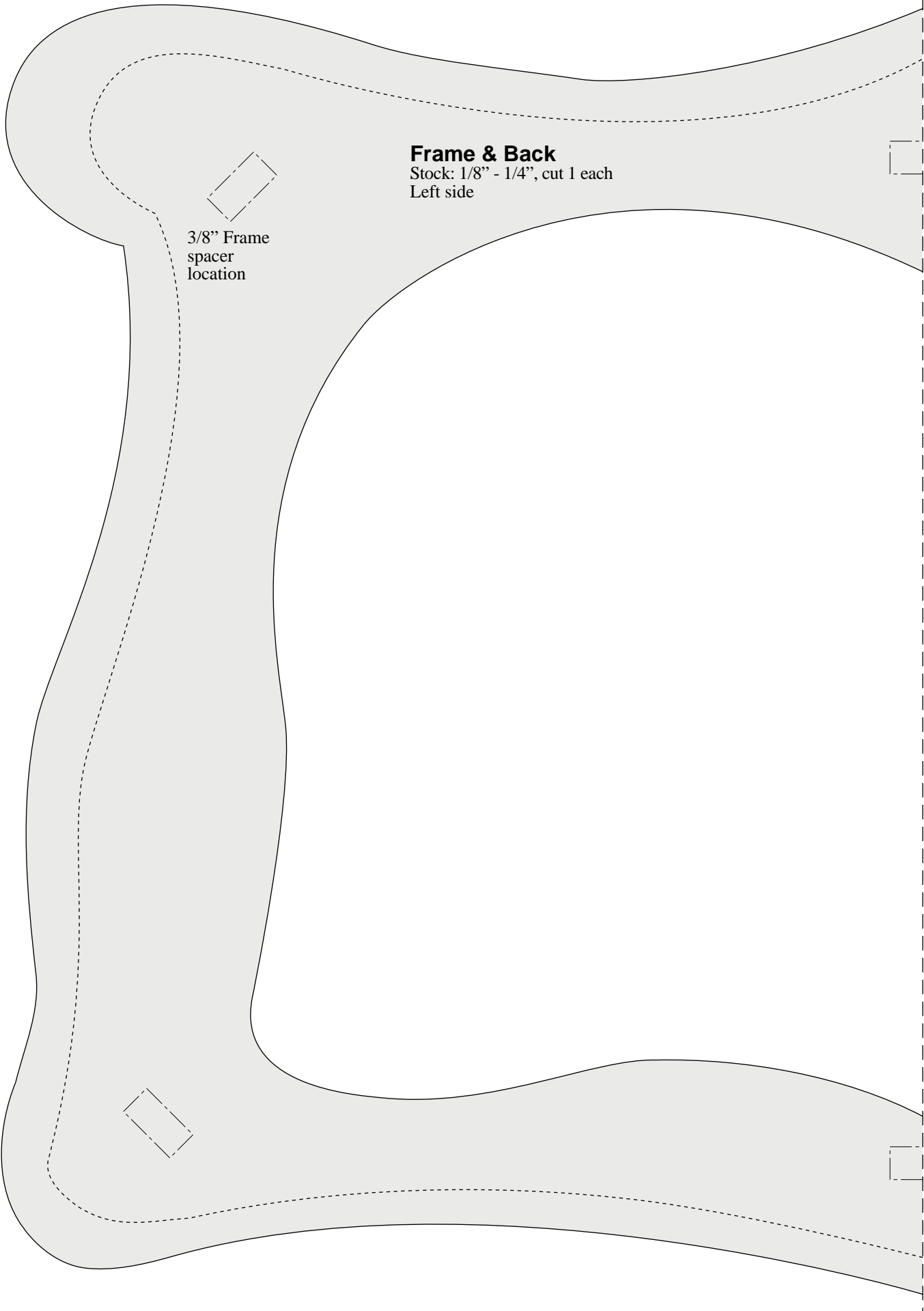

**Frame & Back**

Stock: 1/8" - 1/4", cut 1 each

Left side

3/8" Frame  
spacer  
location

Pattern overlap line

Pattern overlap line

Cut 6 spacer blocks from  
3/8" thick material to  
separate Frame from Back.

Right side

Cut on dashed  
line for Back

Cut on solid line  
for Frame only.

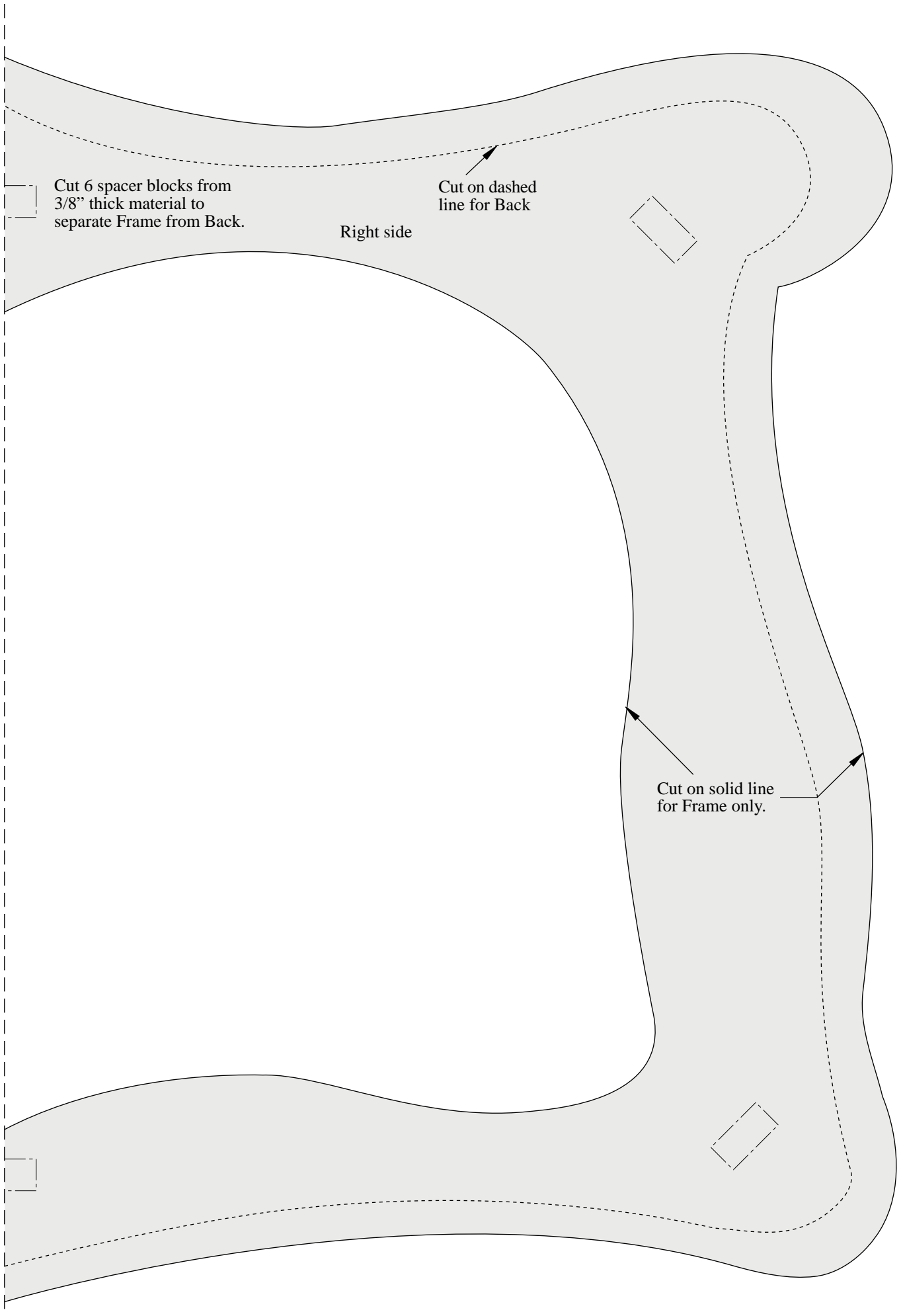

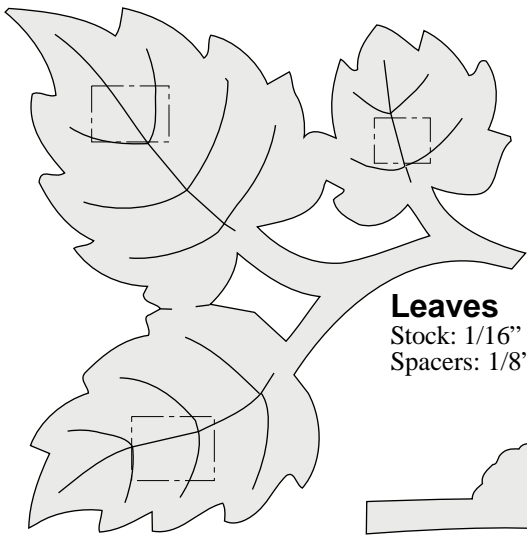

**Leaves**  
Stock: 1/16" - 1/8", cut 2  
Spacers: 1/8", cut 6

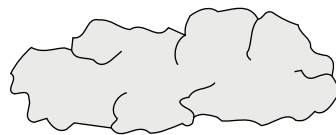

**Left Cloud**  
Stock: 1/16" - 1/8"

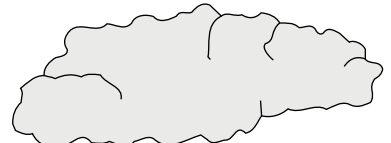

**Right Cloud**  
Stock: 1/16" - 1/8"



**Left Trees**  
Stock: 1/16" - 1/8"

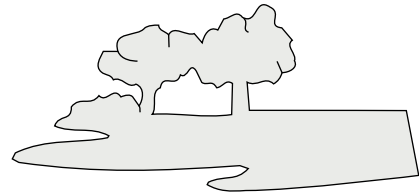

**Right Trees**  
Stock: 1/16" - 1/8"

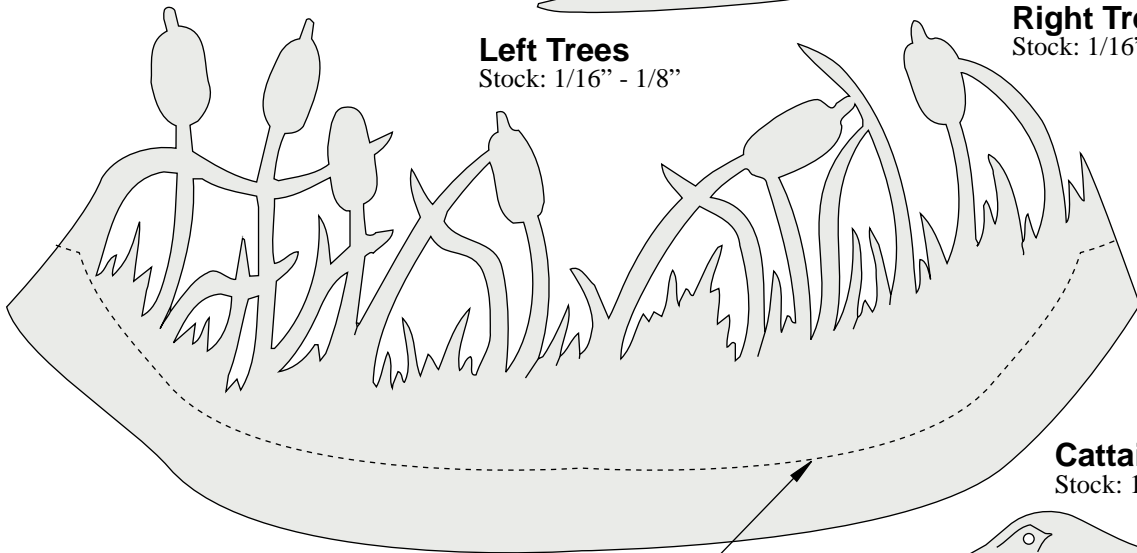

**Cattails**  
Stock: 1/16" - 1/8"

Attach to backside of the  
Frame on dashed line.

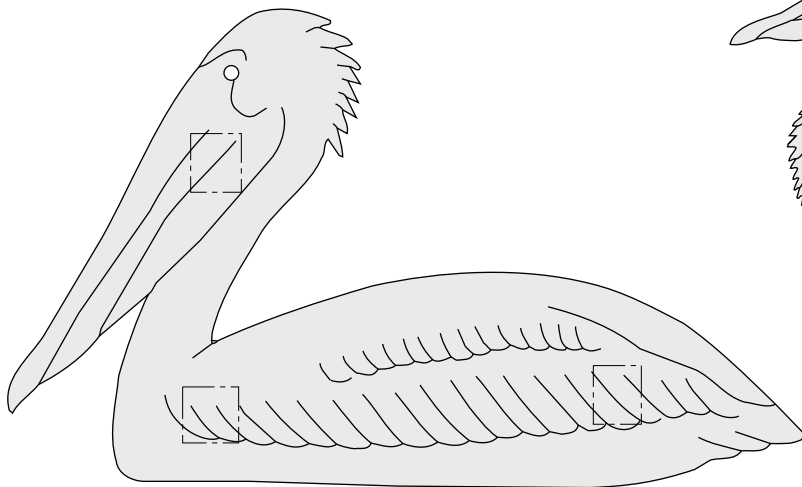

**Left Bird**  
Stock: 1/16" - 1/8"  
Spacers: 1/8", cut 3

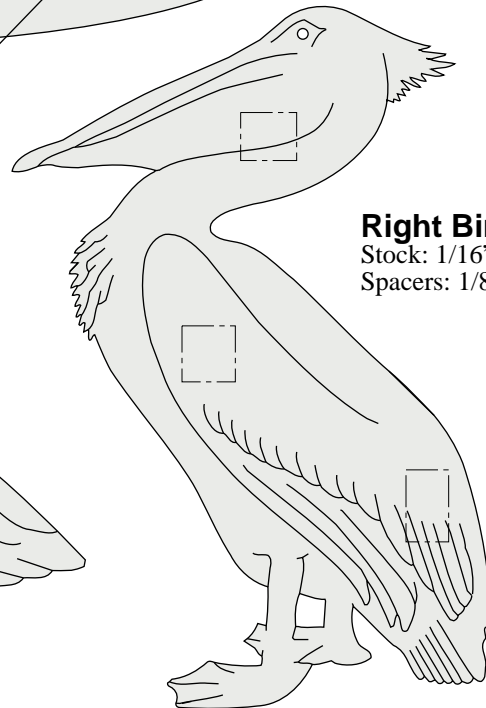

**Right Bird**  
Stock: 1/16" - 1/8"  
Spacers: 1/8", cut 3

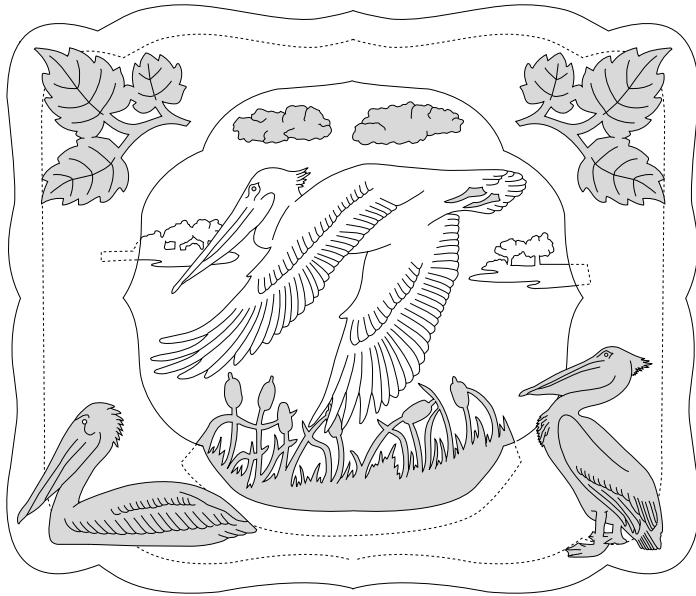

**White Pelican**

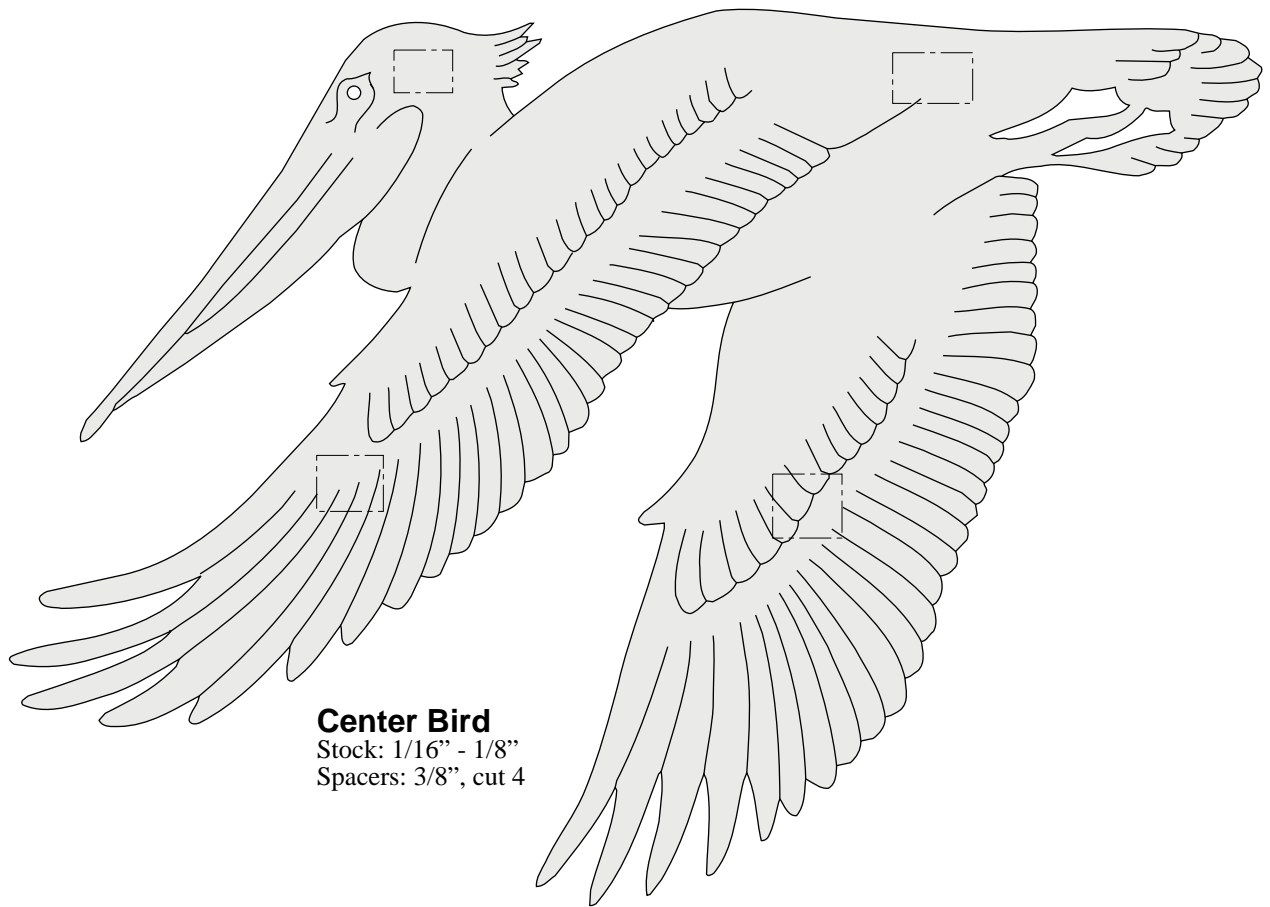

**Center Bird**  
Stock: 1/16" - 1/8"  
Spacers: 3/8", cut 4



**Frame & Back**

Stock: 1/8" - 1/4", cut 1 each  
Left side

3/8" Frame  
spacer  
location

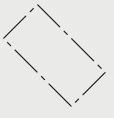
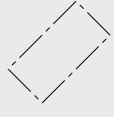

Pattern overlap line





Pattern overlap line

Cut 6 spacer blocks from  
3/8" thick material to  
separate Frame from Back.

Right side

Cut on dashed line  
for Back

Cut on solid line  
for Frame only.

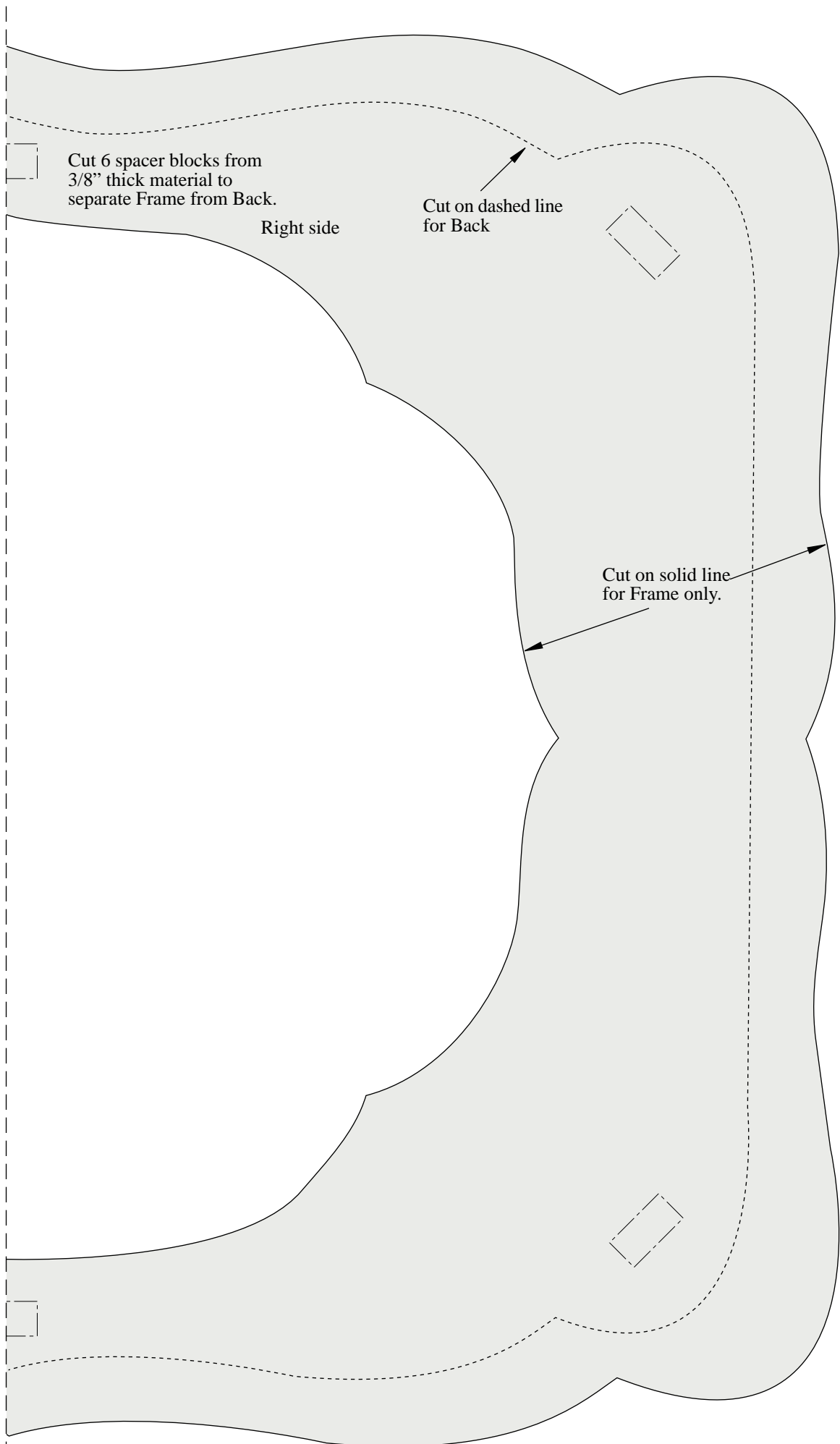

**Left Cloud**

Stock: 1/16" - 1/8"



**Center Cloud**

Stock: 1/16" - 1/8"  
Spacers: 1/8", cut 2

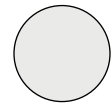
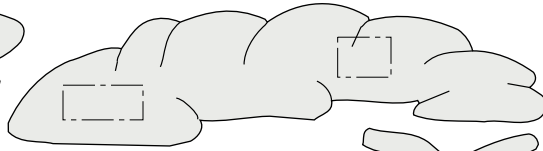

**Moon**

Stock: 1/16" - 1/8"



**Right Cloud**

Stock: 1/16" - 1/8"

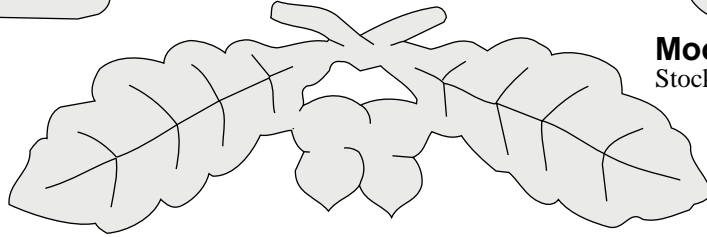

**Overlay Leaves**

Stock: 1/16" - 1/8", cut 2

**Right Back Trees**

Stock: 1/16" - 1/8"  
Spacers: 1/8", cut 3

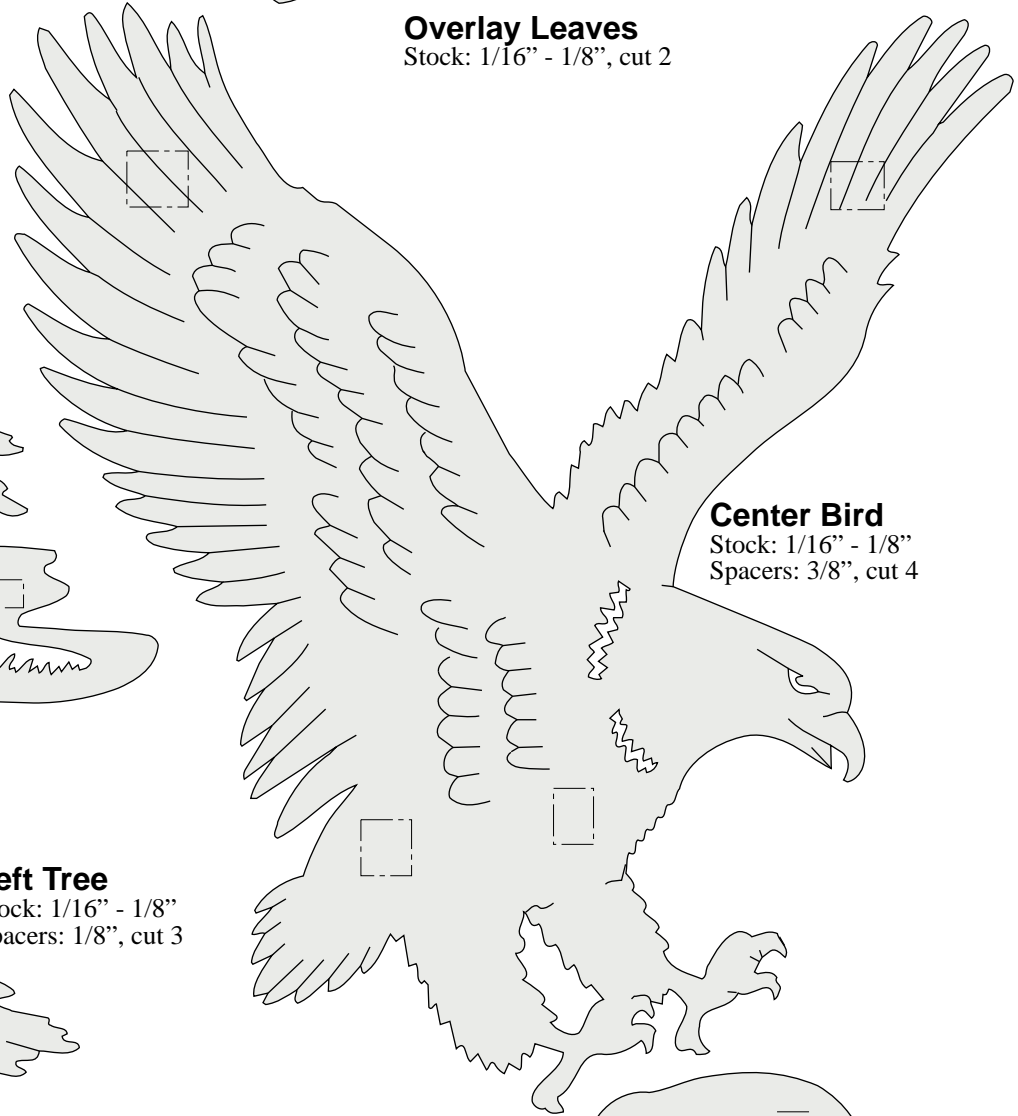

**Center Bird**

Stock: 1/16" - 1/8"  
Spacers: 3/8", cut 4

**Left Tree**

Stock: 1/16" - 1/8"  
Spacers: 1/8", cut 3

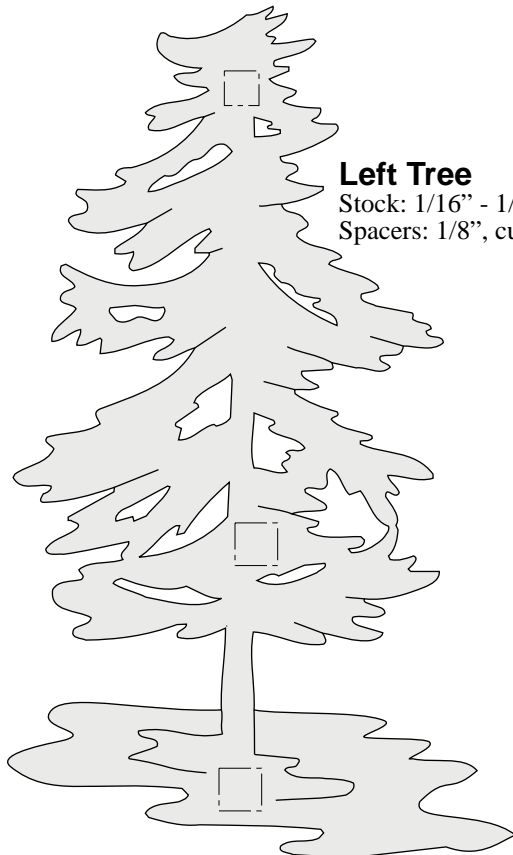

**Deer**

Stock: 1/16" - 1/8"  
Spacers: 1/8", cut 2

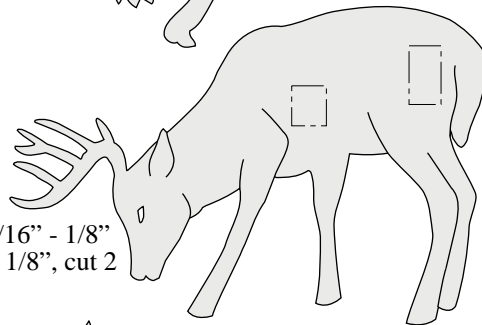

**Grass**

Stock: 1/16" - 1/8"

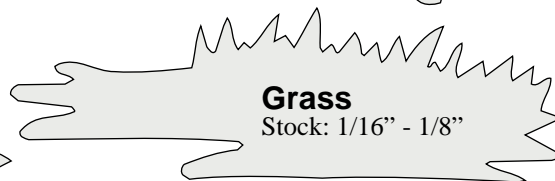

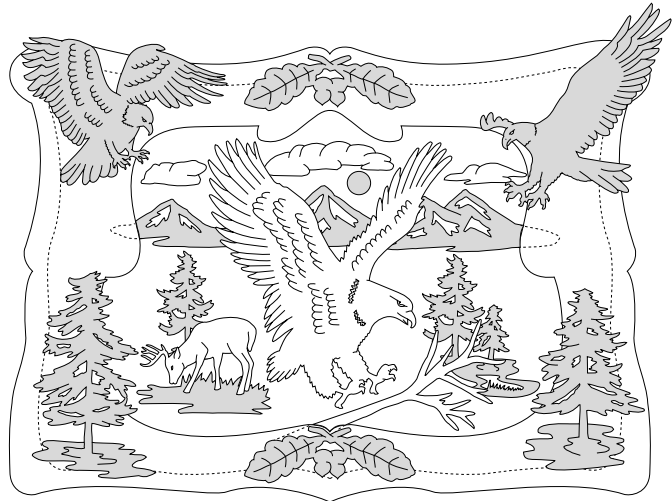

**American Bald Eagle**

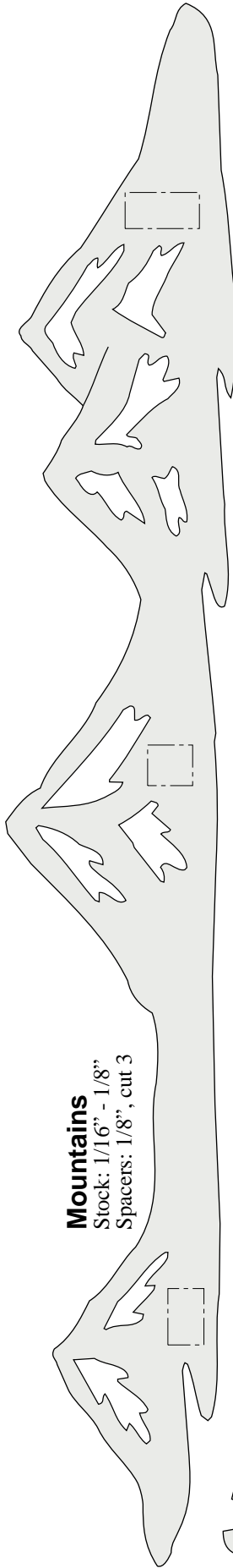

**Mountains**  
Stock: 1/16" - 1/8"  
Spacers: 1/8", cut 3

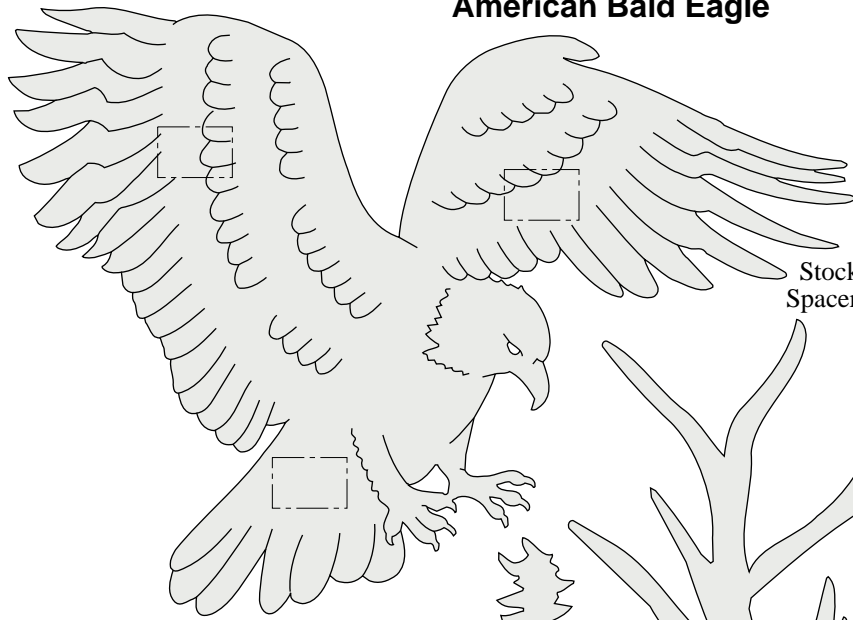

**Left Bird**  
Stock: 1/16" - 1/8"  
Spacers: 1/8", cut 3

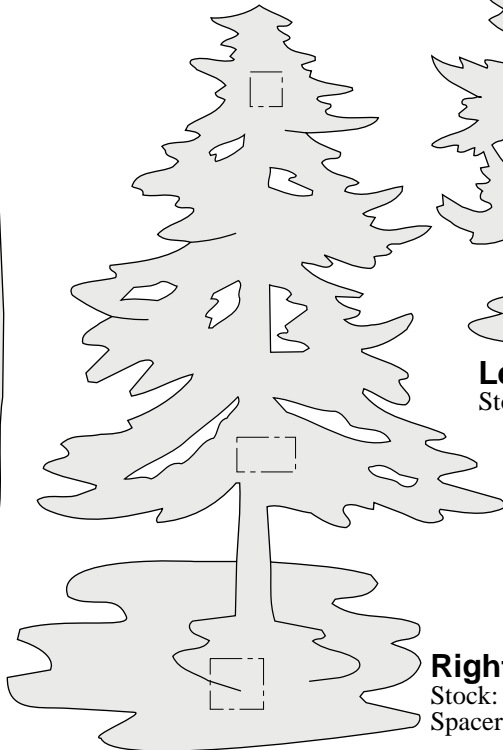

**Left Back Tree**  
Stock: 1/16" - 1/8"

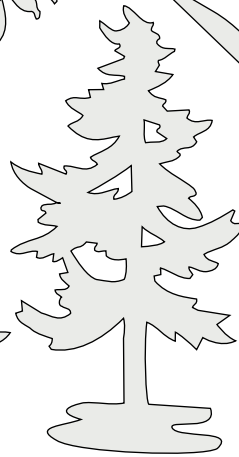

**Right Tree**  
Stock: 1/16" - 1/8"  
Spacers: 1/8", cut 3

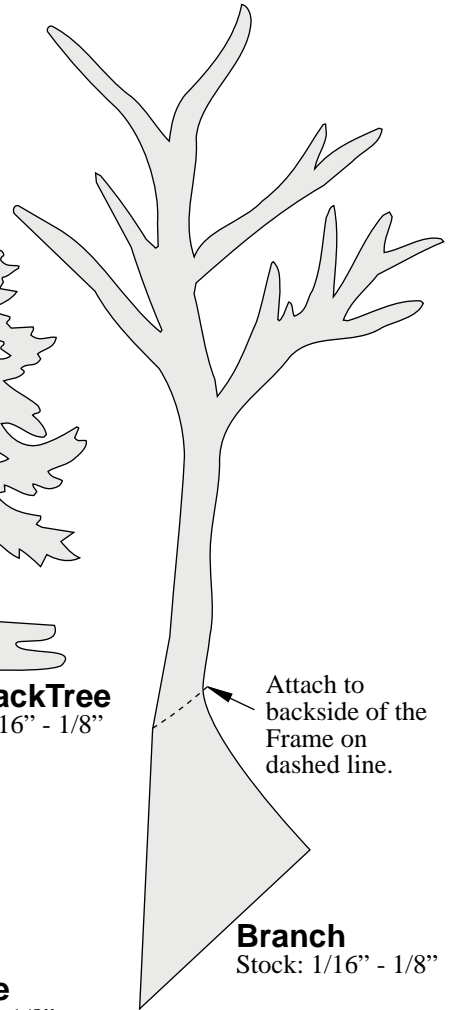

**Branch**  
Stock: 1/16" - 1/8"

Attach to backside of the Frame on dashed line.

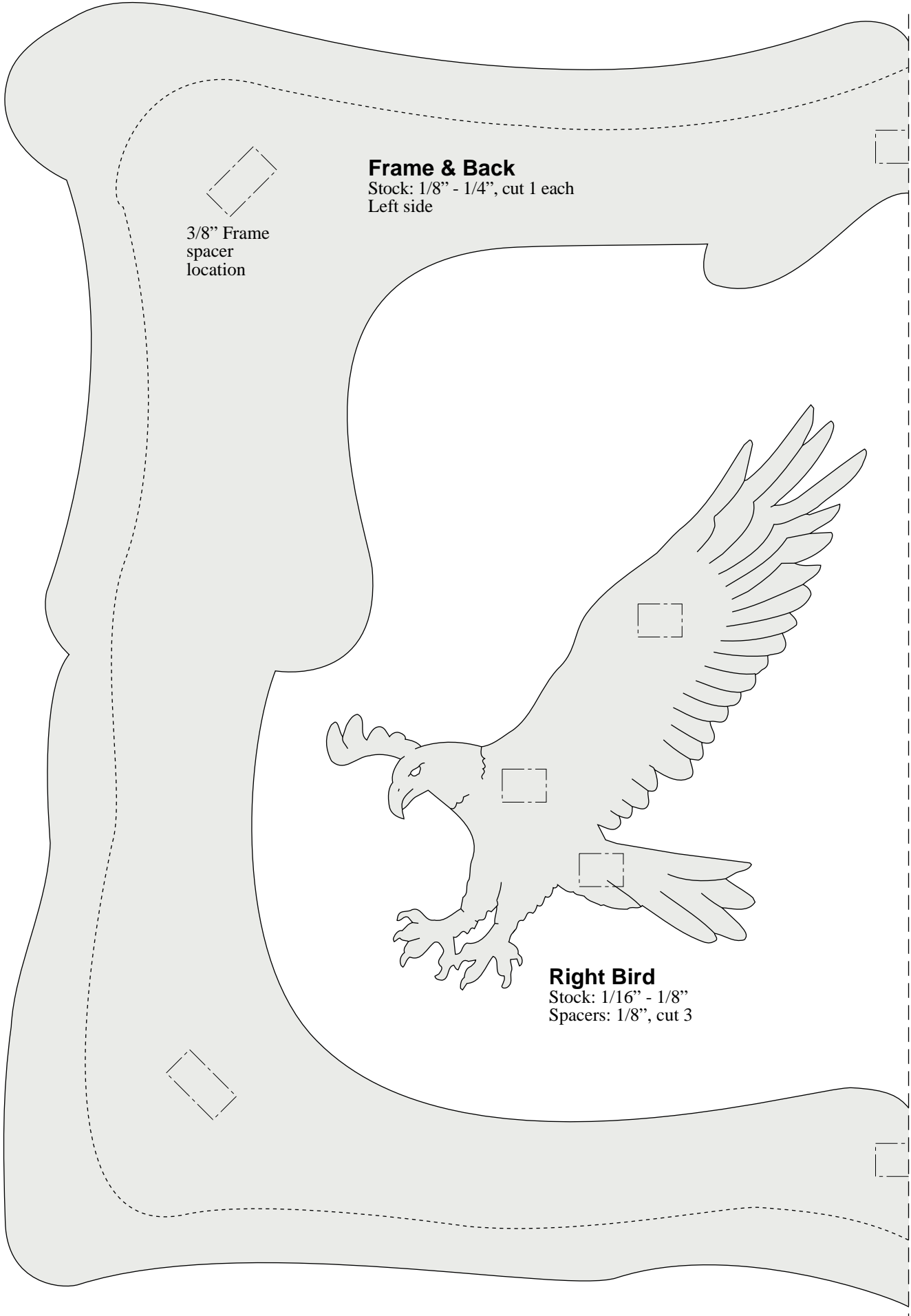

**Frame & Back**

Stock: 1/8" - 1/4", cut 1 each  
Left side

3/8" Frame  
spacer  
location

**Right Bird**

Stock: 1/16" - 1/8"  
Spacers: 1/8", cut 3

Pattern overlap line

Pattern overlap line

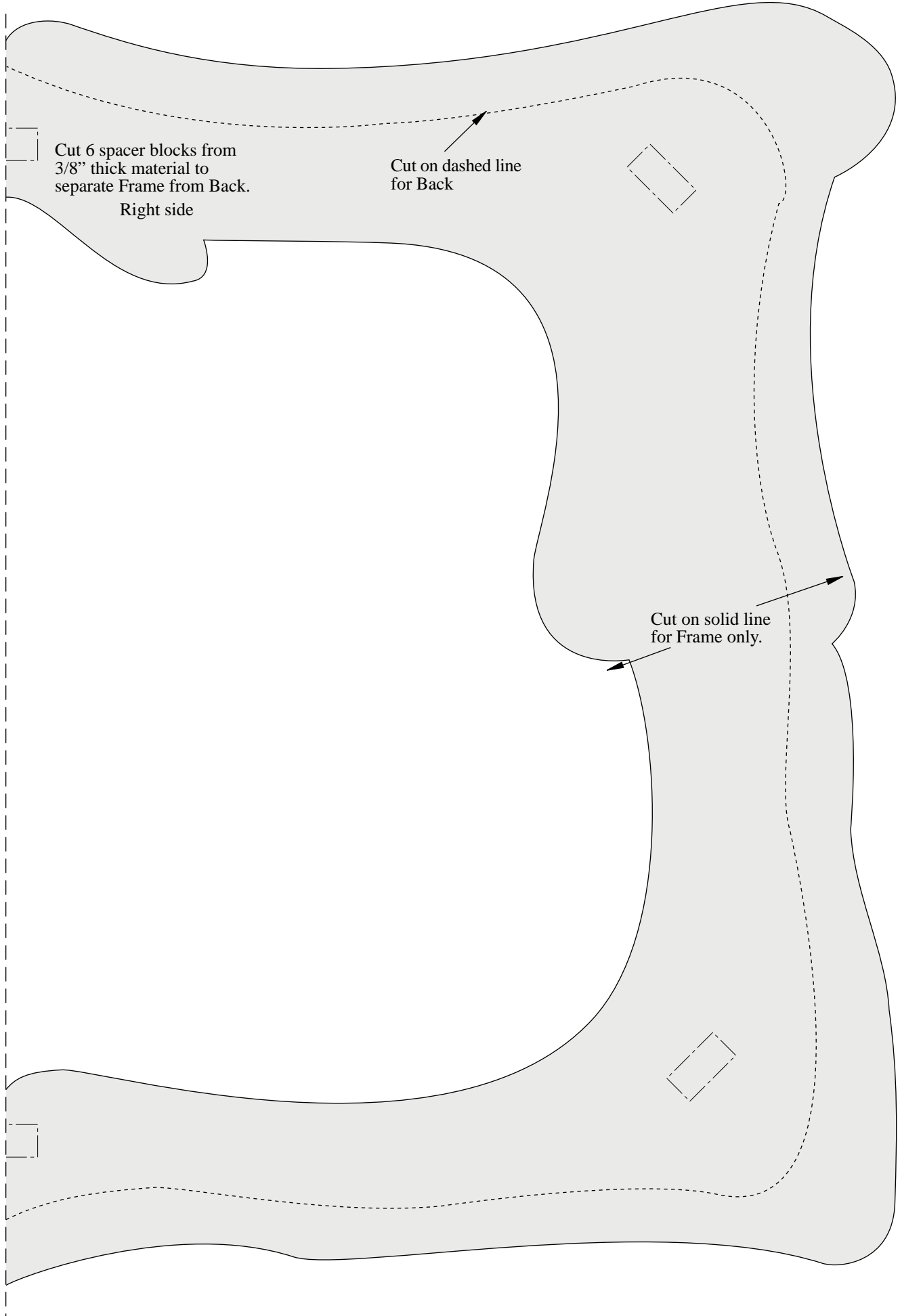

Cut 6 spacer blocks from  
3/8" thick material to  
separate Frame from Back.  
Right side

Cut on dashed line  
for Back

Cut on solid line  
for Frame only.

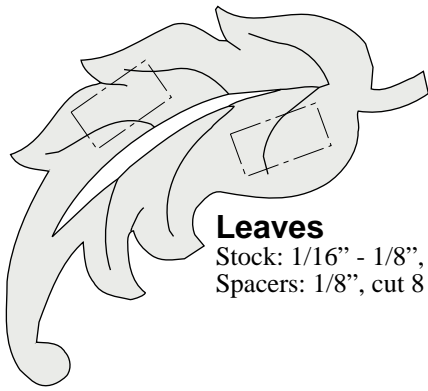

**Leaves**

Stock: 1/16" - 1/8", cut 4  
Spacers: 1/8", cut 8

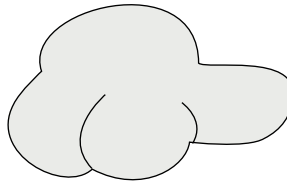

**Left Cloud**

Stock: 1/16" - 1/8"

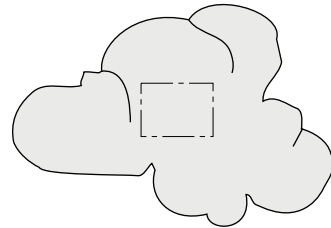

**Right Cloud**

Stock: 1/16" - 1/8"  
Spacer: 1/8"

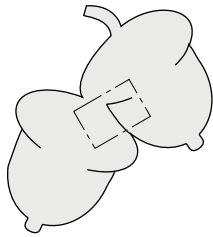

**Acorns**

Stock: 1/16" - 1/8", cut 2  
Spacer: 1/8", cut 2

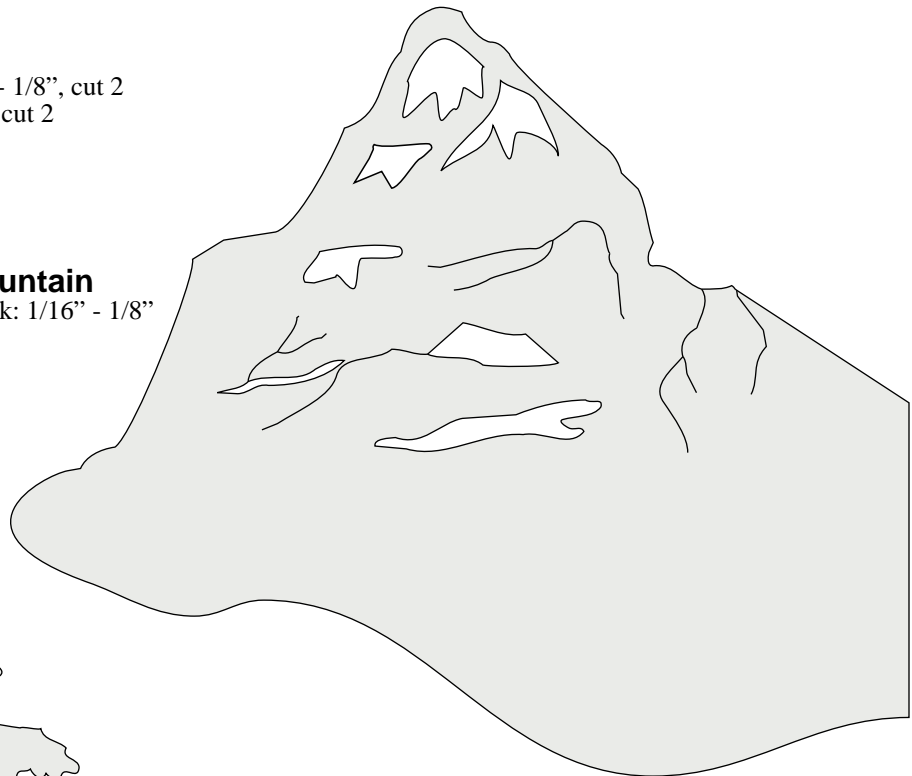

**Mountain**

Stock: 1/16" - 1/8"

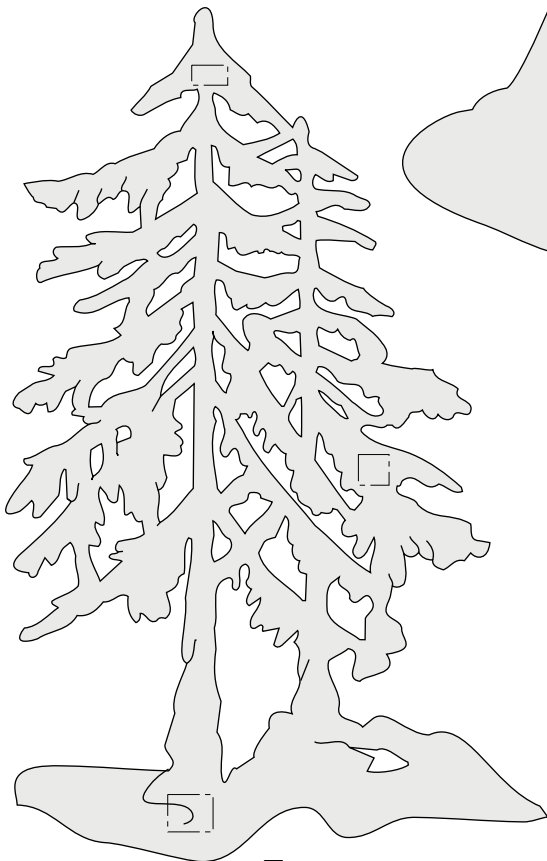

**Trees**

Stock: 1/16" - 1/8"  
Spacers: 1/8", cut 3

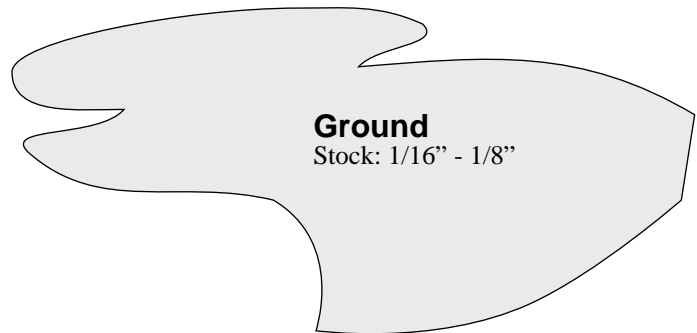

**Ground**

Stock: 1/16" - 1/8"

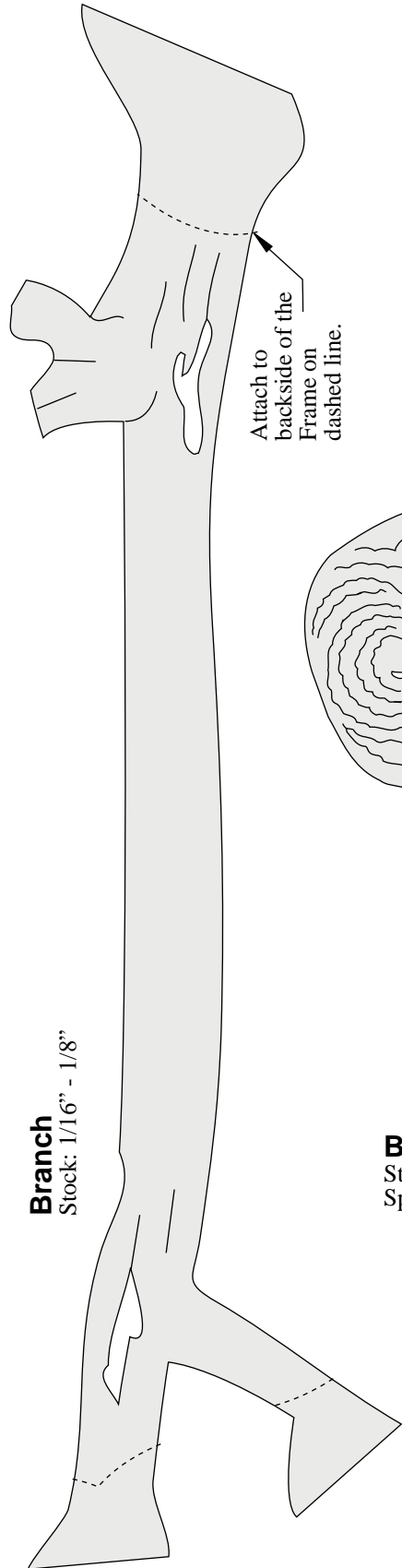

**Great Grey Owl**

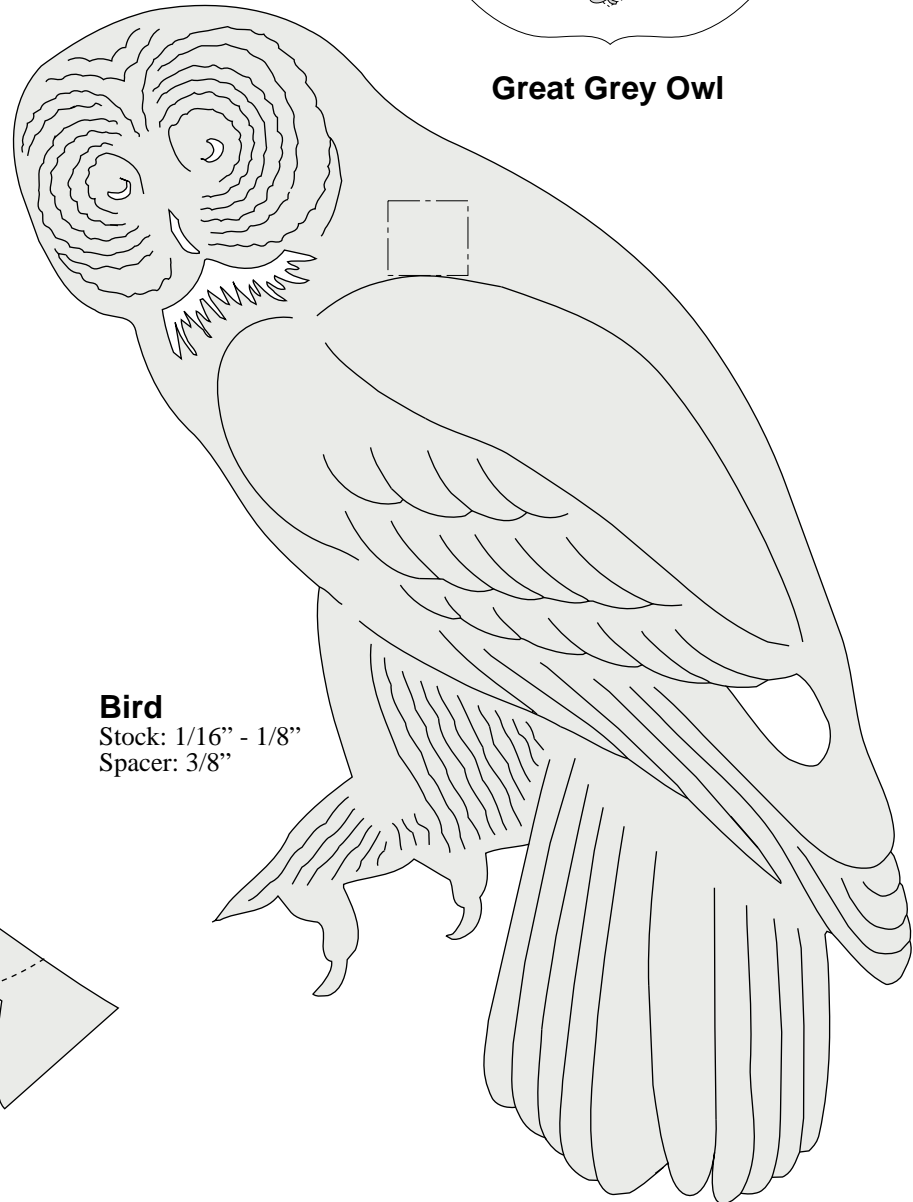

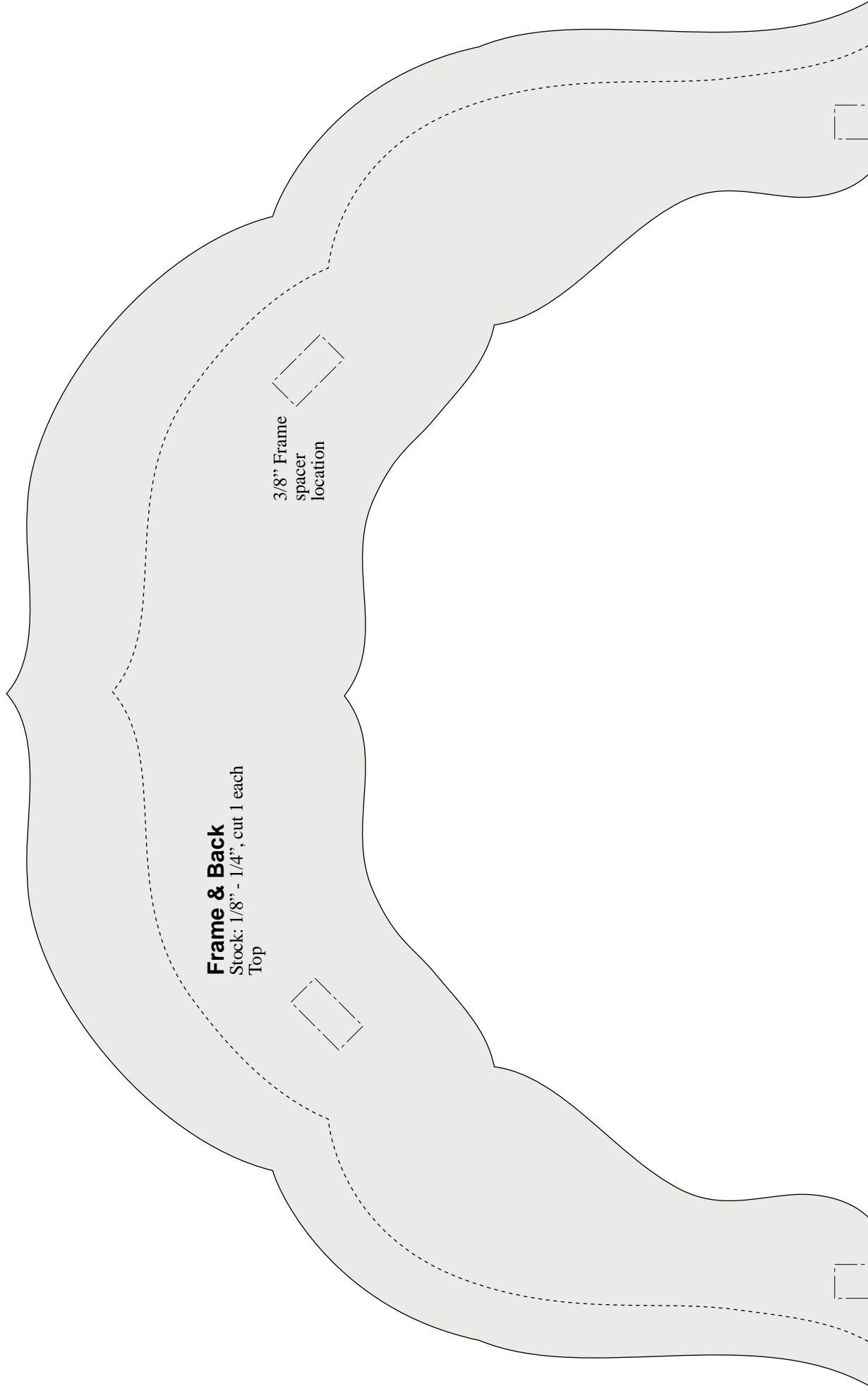

**Frame & Back**

Stock: 1/8" - 1/4", cut 1 each  
Top

3/8" Frame  
spacer  
location

Pattern overlap line



Pattern overlap line

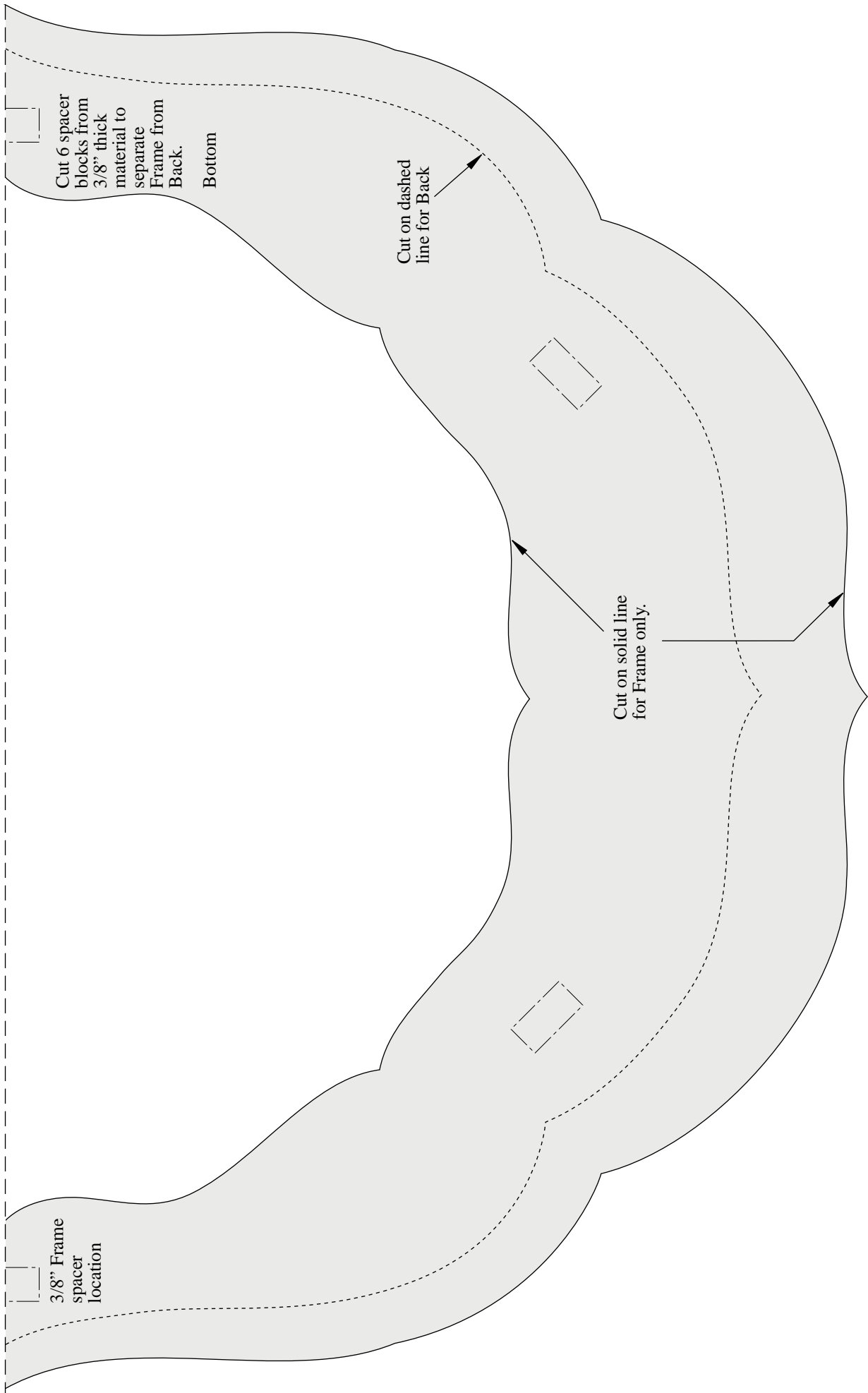

3/8" Frame spacer location

Cut 6 spacer blocks from 3/8" thick material to separate Frame from Back. Bottom

Cut on dashed line for Back

Cut on solid line for Frame only.

**Left Peak**

Stock: 1/16" - 1/8"

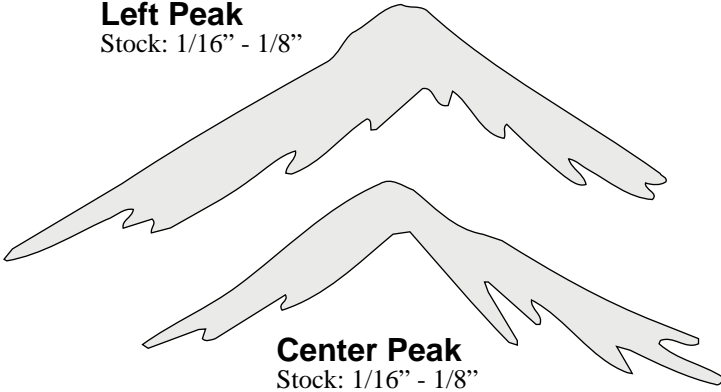

**Center Peak**

Stock: 1/16" - 1/8"

**Right Peak**

Stock: 1/16" - 1/8"



**Mountain**

Stock: 1/16" - 1/8"  
Spacers: 1/8", cut 3

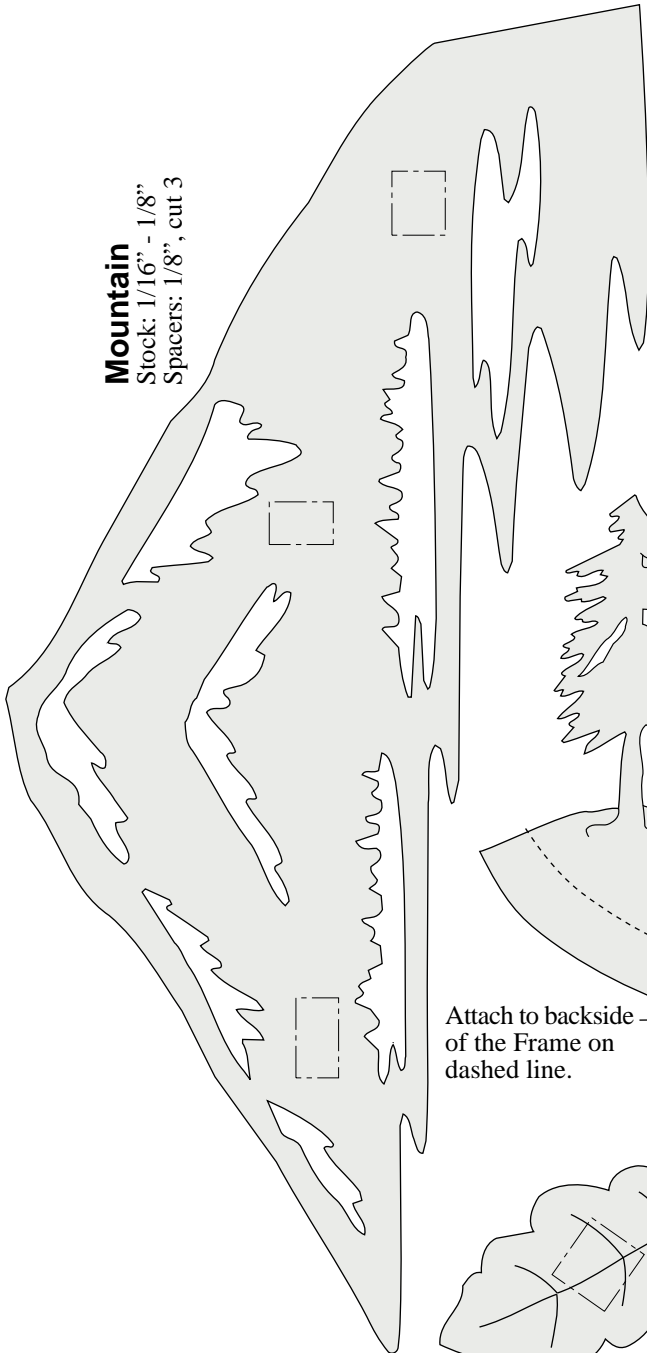

**Water**

Stock: 1/16" - 1/8"

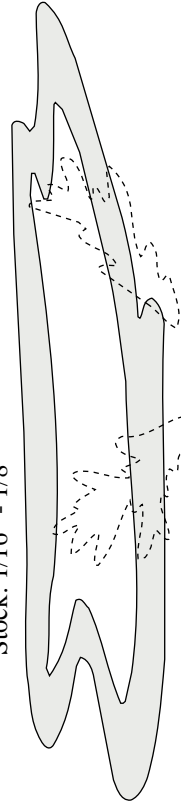

**Right Trees**

Stock: 1/16" - 1/8"  
Spacers: 1/8", cut 3

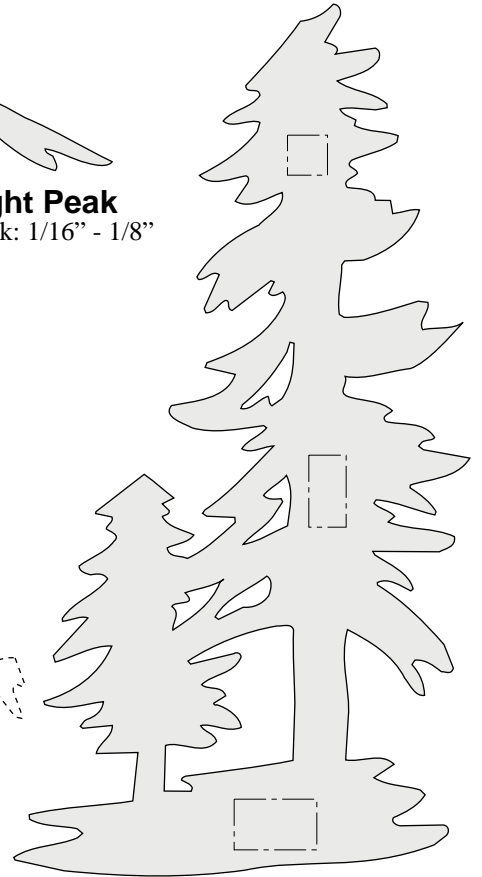

**Fish**

Stock: 1/16" - 1/8"  
Spacers: 1/4", cut 2

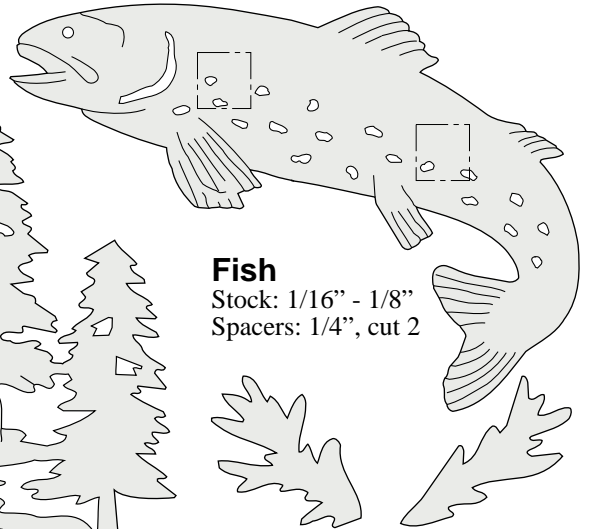

Attach to backside of the Frame on dashed line.

**Left Trees**

Stock: 1/16" - 1/8"

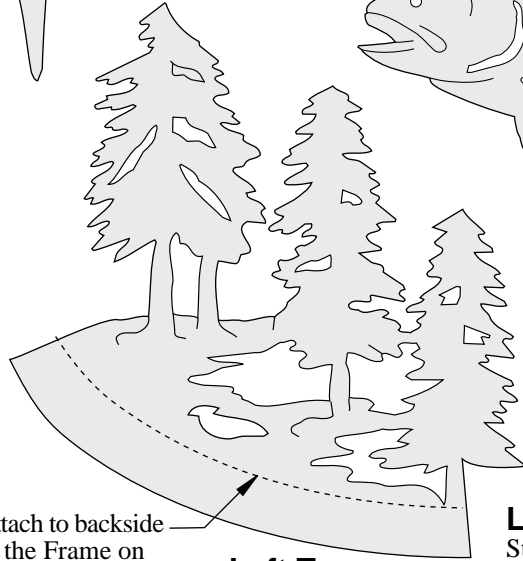

**Left Splash**

Stock: 1/16" - 1/8"  
Attach to front of Water.

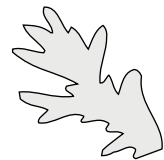

**Right Splash**

Stock: 1/16" - 1/8".  
Attach to front of Water.

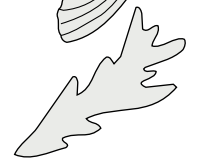

**Leaves**

Stock: 1/16" - 1/8", cut 3  
Spacers: 1/8", cut 6

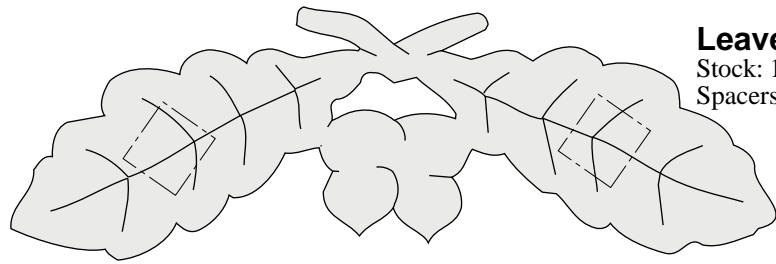

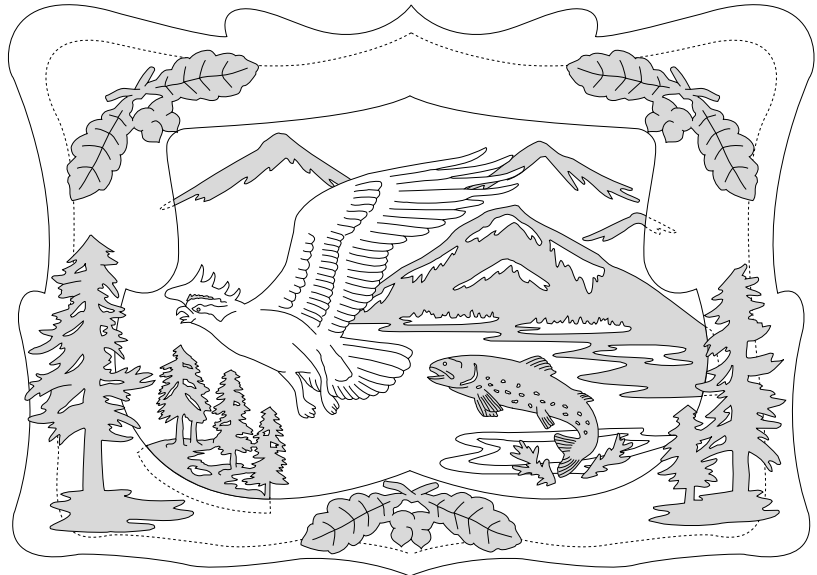

**Osprey**

**Left Trees**

Stock: 1/16" - 1/8"  
Spacers: 1/8", cut 3

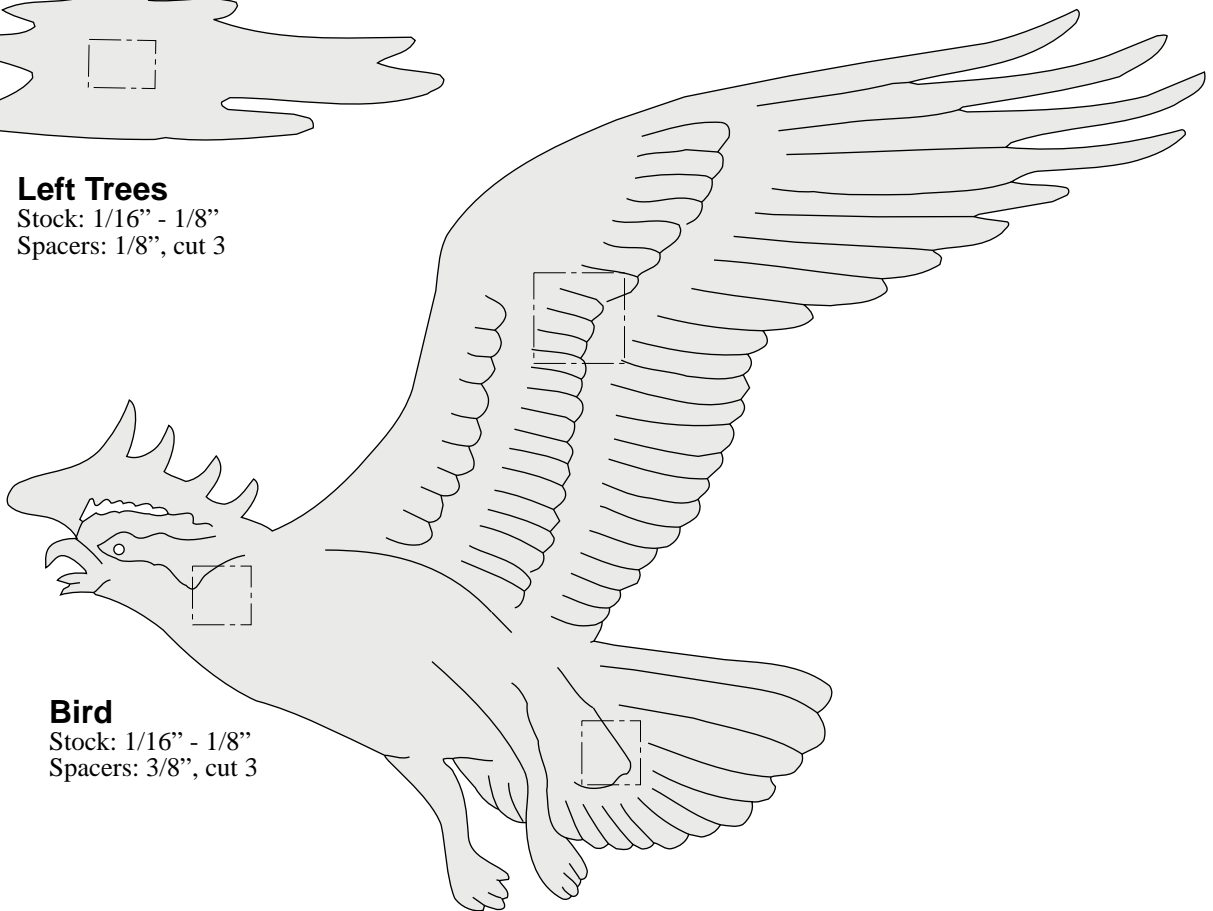

**Bird**

Stock: 1/16" - 1/8"  
Spacers: 3/8", cut 3

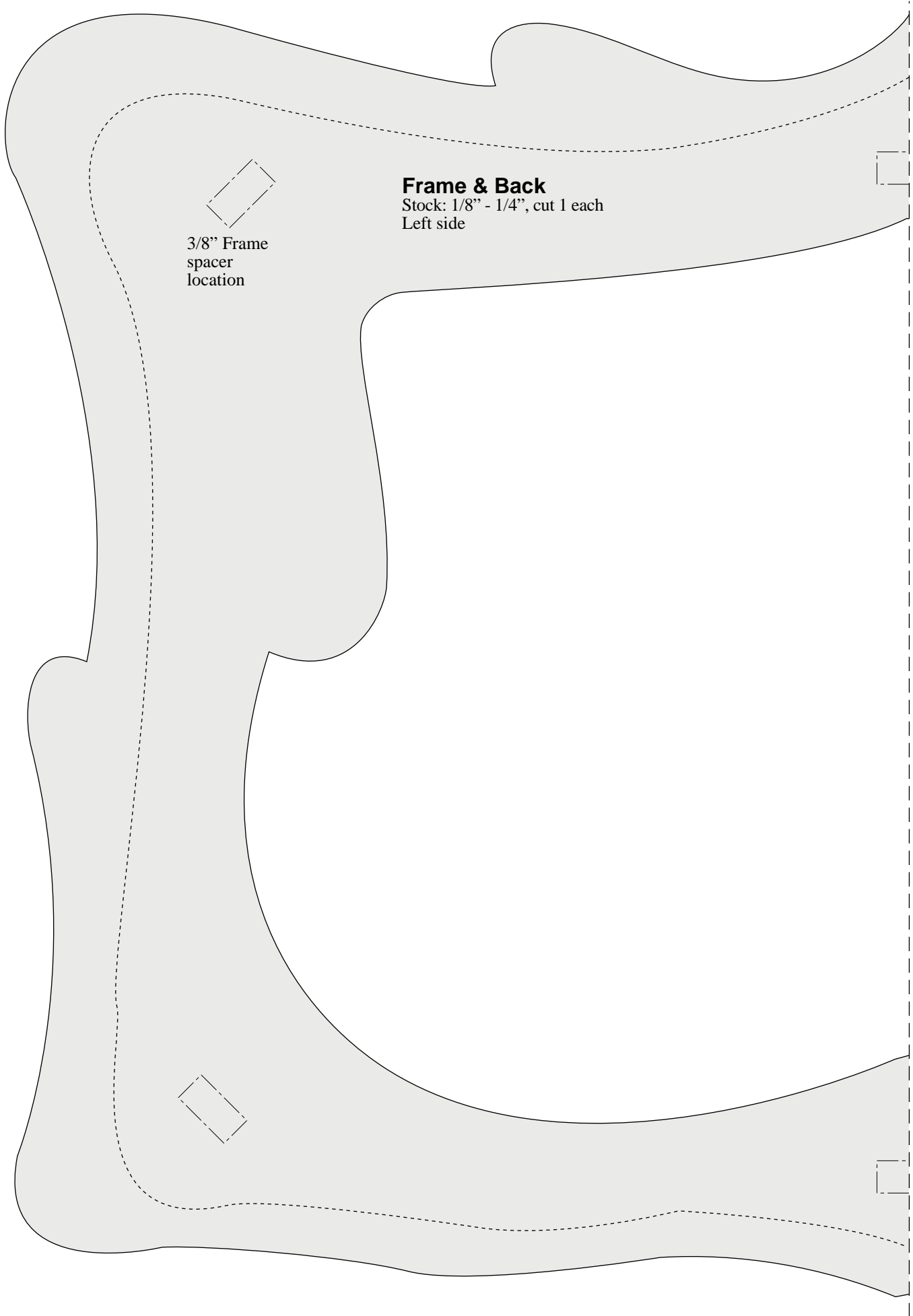

3/8" Frame  
spacer  
location

**Frame & Back**  
Stock: 1/8" - 1/4", cut 1 each  
Left side

Pattern overlap line

Pattern overlap line

Cut 6 spacer blocks from  
3/8" thick material to  
separate Frame from Back.

Right side

Cut on dashed line  
for Back

Cut on solid line  
for Frame only.

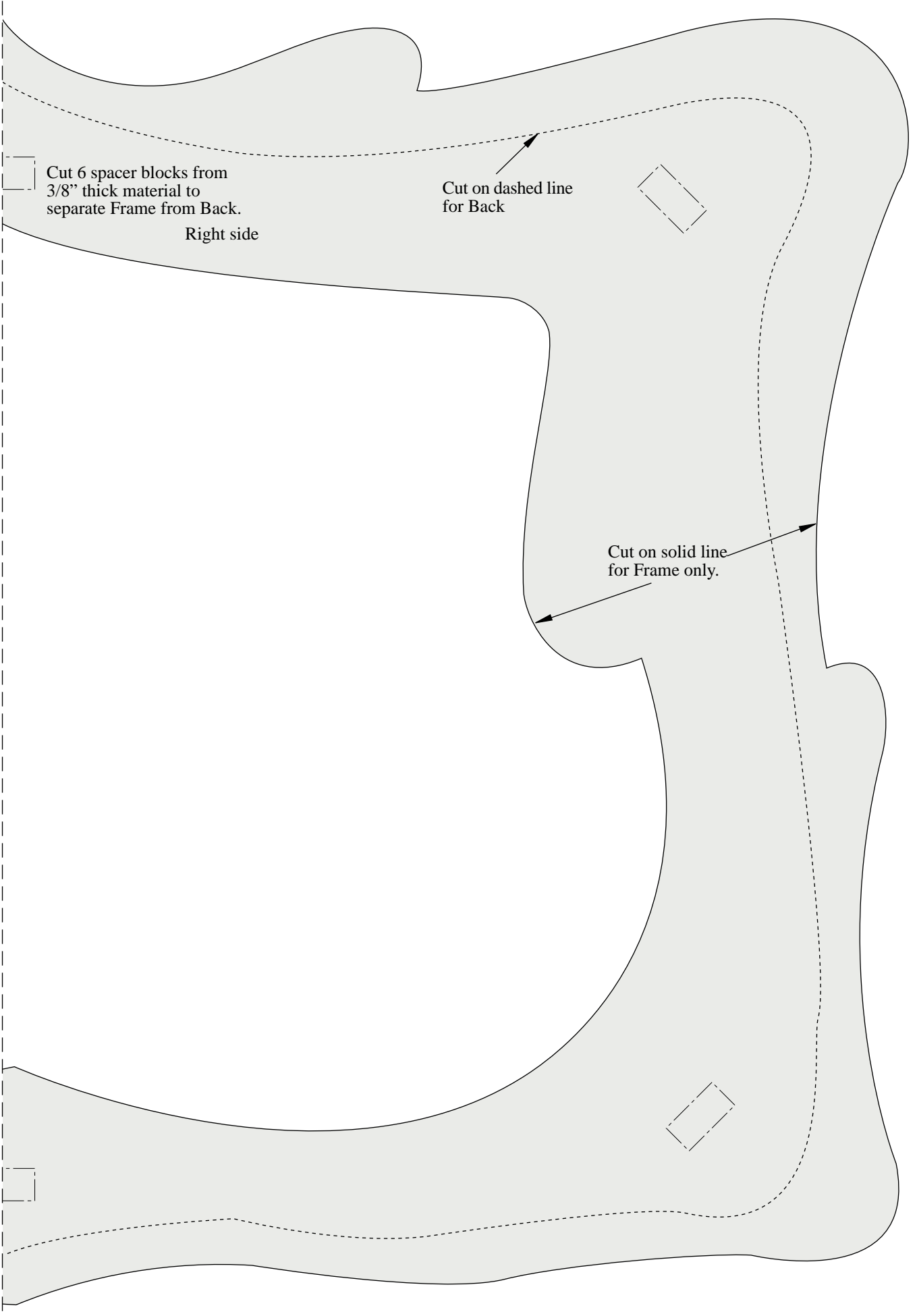



**Top Branch**  
Stock: 1/16" - 1/8"  
Spacers: 1/8", cut 4

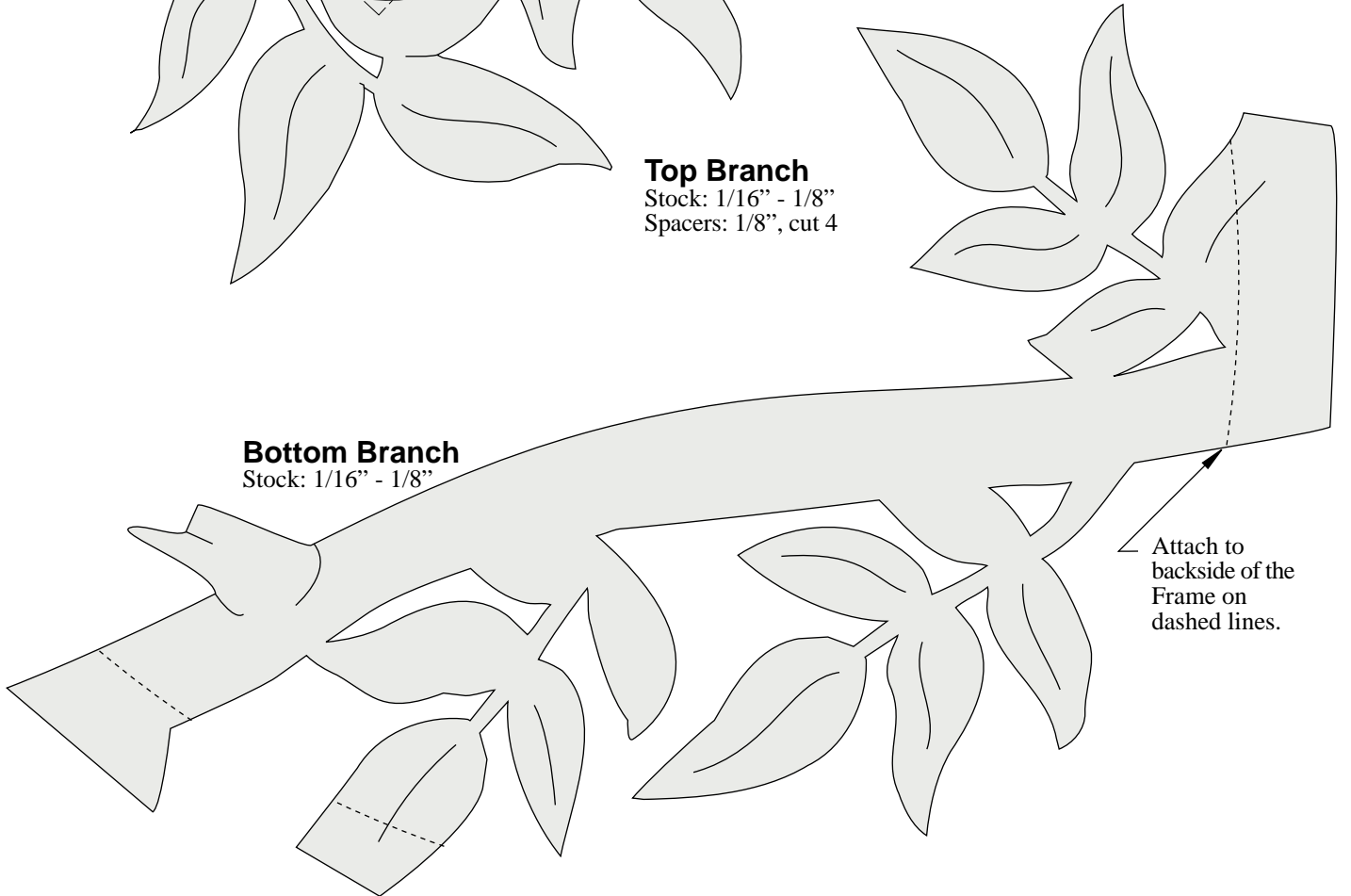

**Bottom Branch**  
Stock: 1/16" - 1/8"

Attach to  
backside of the  
Frame on  
dashed lines.

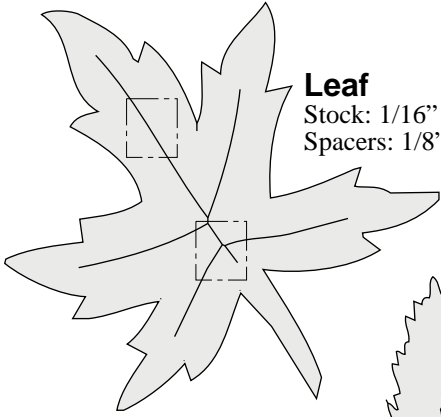

**Leaf**  
Stock: 1/16" - 1/8", cut 2  
Spacers: 1/8", cut 4

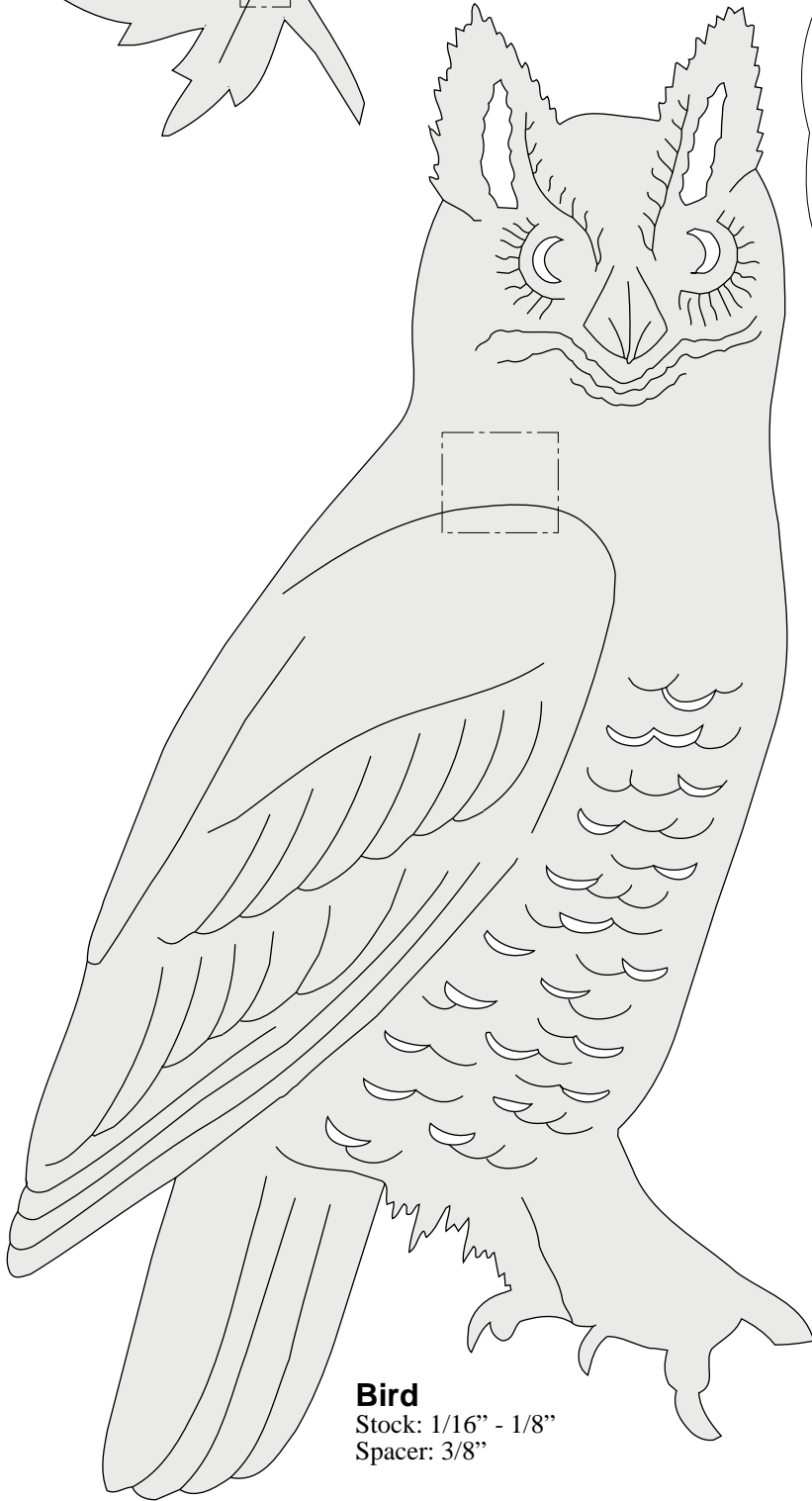

**Bird**  
Stock: 1/16" - 1/8"  
Spacer: 3/8"



**Great Horned Owl**

Attach to  
backside of the  
Frame on  
dashed lines.

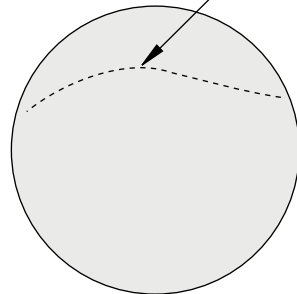

**Moon**  
Stock: 1/16" - 1/8"

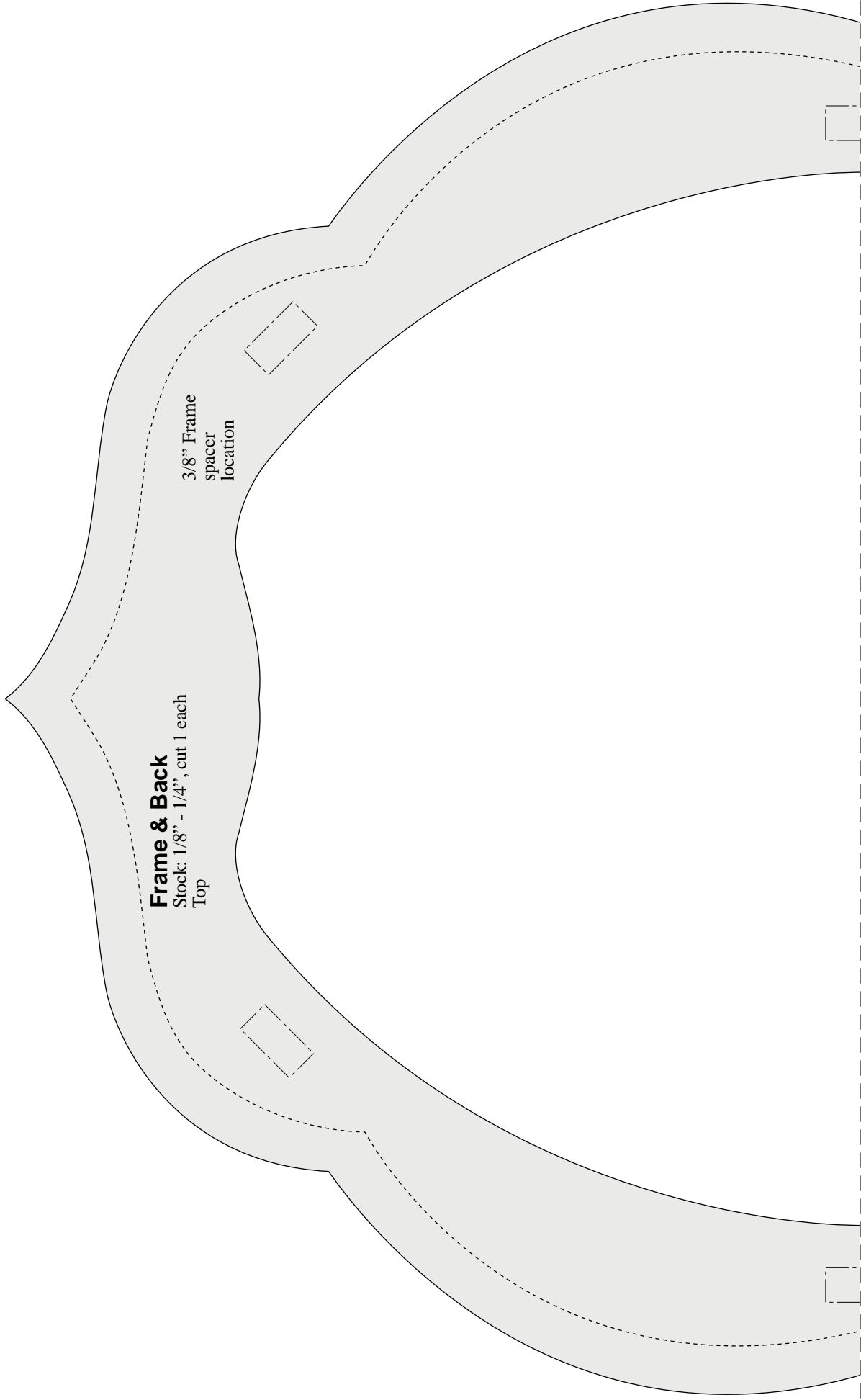

**Frame & Back**

Stock: 1/8" - 1/4", cut 1 each  
Top

3/8" Frame  
spacer  
location

Pattern overlap line



Pattern overlap line

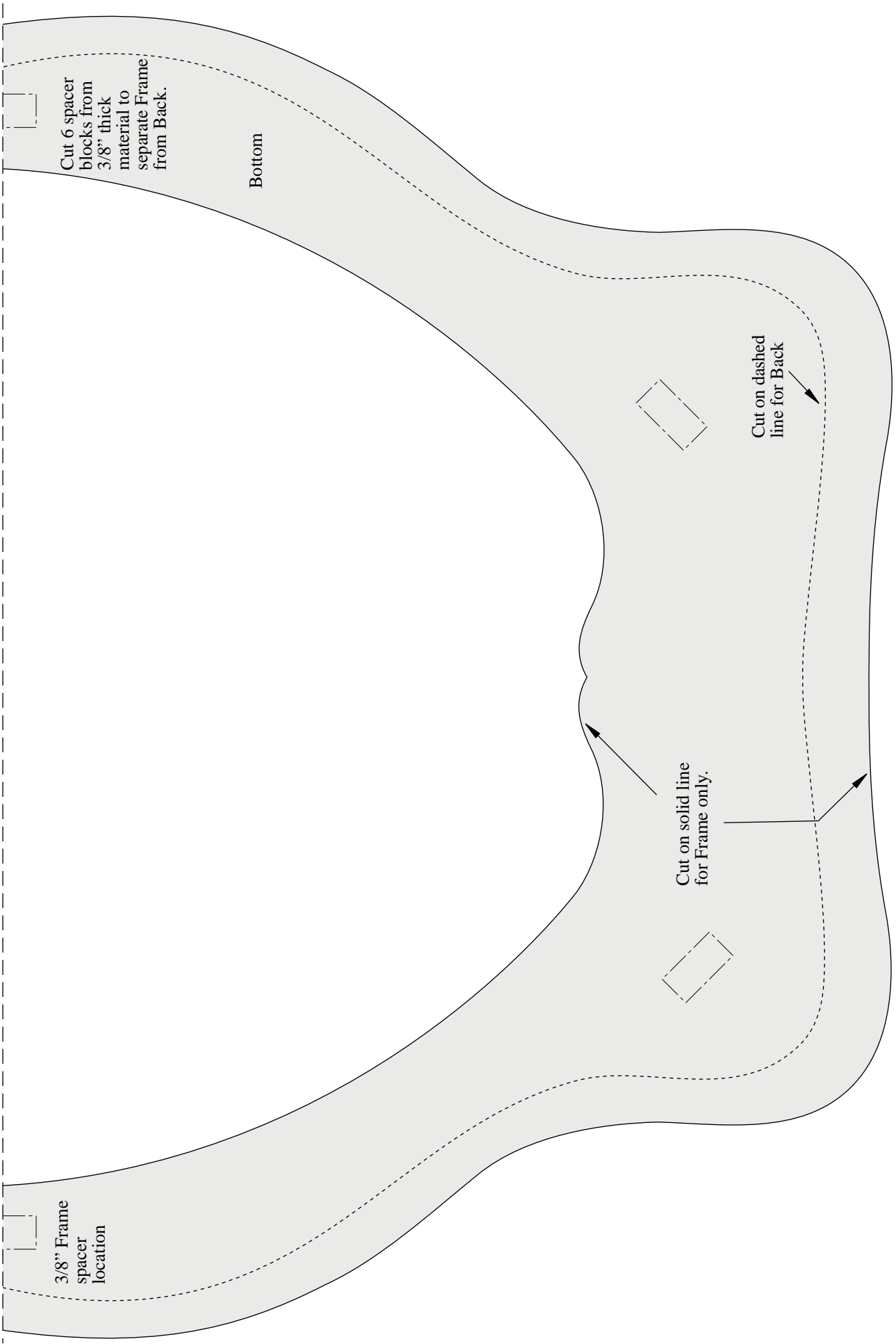

3/8" Frame spacer location



Cut 6 spacer blocks from 3/8" thick material to separate Frame from Back.

Bottom

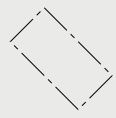

Cut on dashed line for Back

Cut on solid line for Frame only.

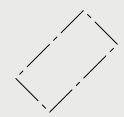

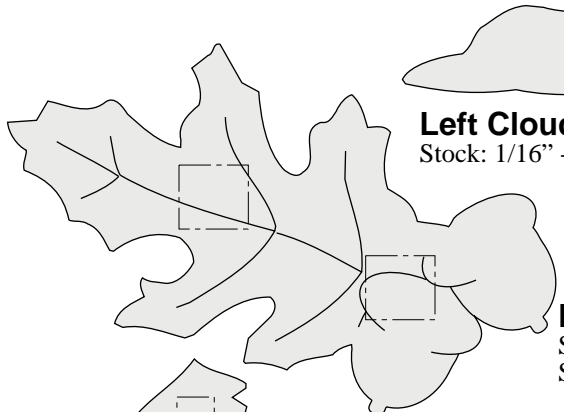

**Left Cloud**  
Stock: 1/16" - 1/8"

**Leaves**  
Stock: 1/16" - 1/8", cut 2  
Spacers: 1/8", cut 4

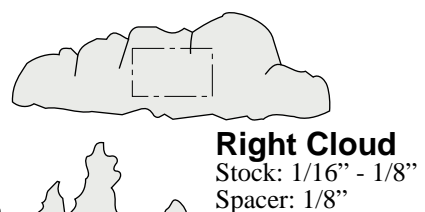

**Right Cloud**  
Stock: 1/16" - 1/8"  
Spacer: 1/8"

**Right Horizon**  
Stock: 1/16" - 1/8"

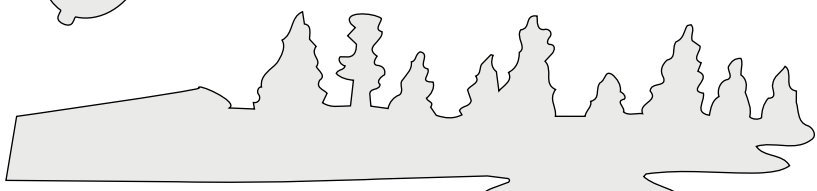

**Left Horizon**  
Stock: 1/16" - 1/8"

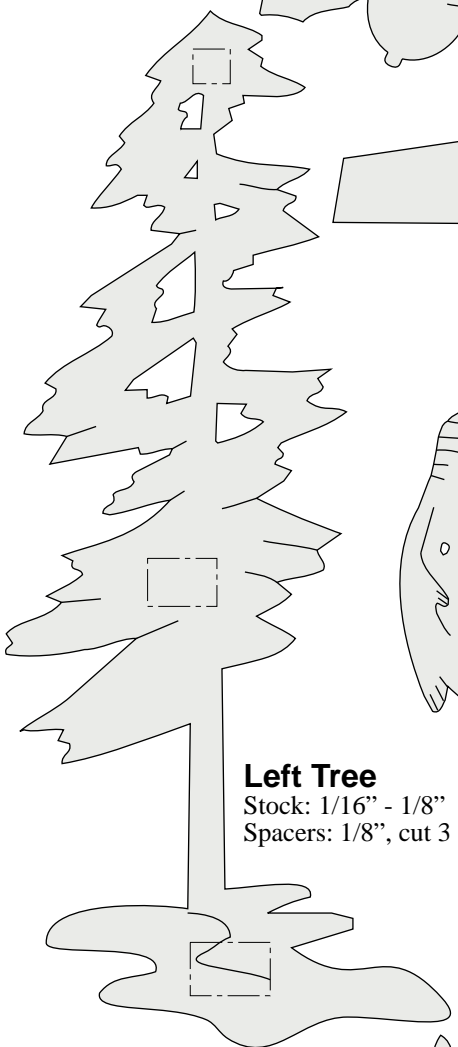

**Left Tree**  
Stock: 1/16" - 1/8"  
Spacers: 1/8", cut 3

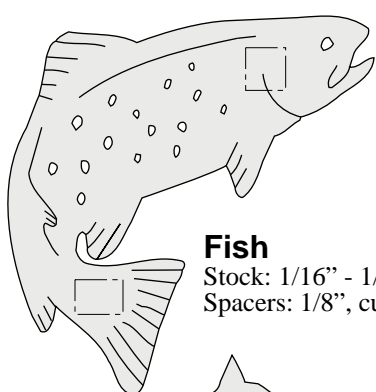

**Fish**  
Stock: 1/16" - 1/8"  
Spacers: 1/8", cut 2

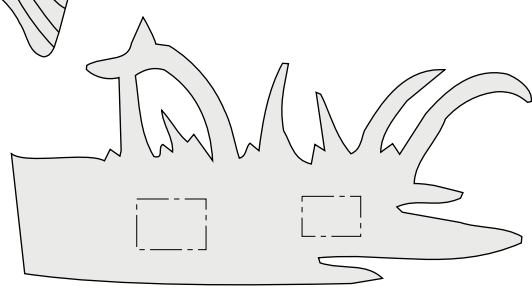

**Grass**  
Stock: 1/16" - 1/8"  
Spacers: 1/8", cut 2

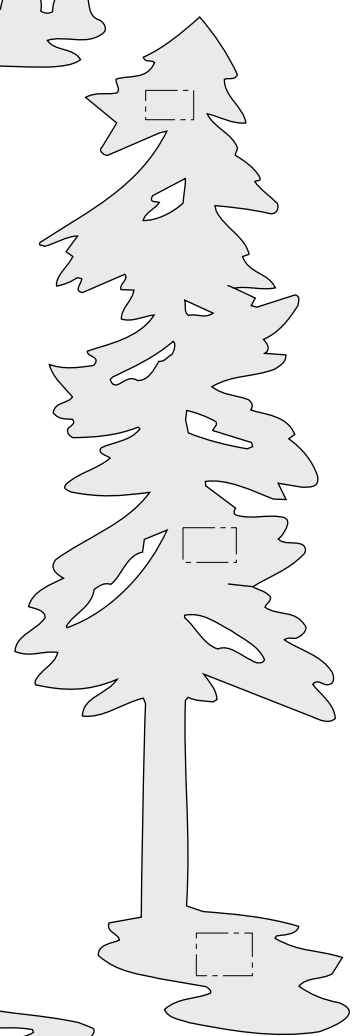

**Right Tree**  
Stock: 1/16" - 1/8"  
Spacers: 1/8", cut 3

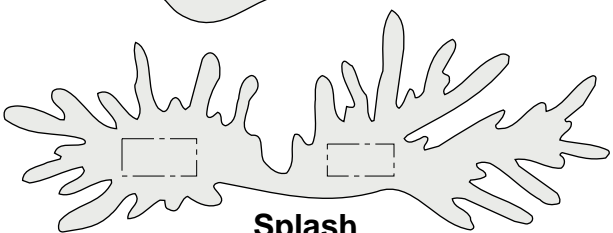

**Splash**  
Stock: 1/16" - 1/8"  
Spacers: 1/4", cut 2

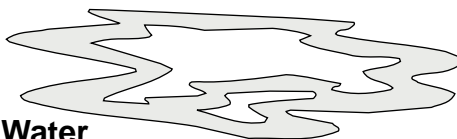

**Water**  
Stock: 1/16" - 1/8"

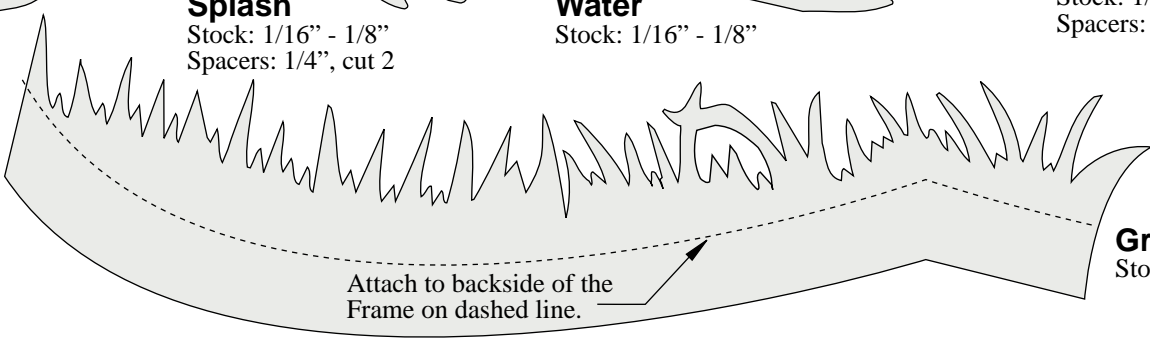

Attach to backside of the Frame on dashed line.

**Grass**  
Stock: 1/16" - 1/8"

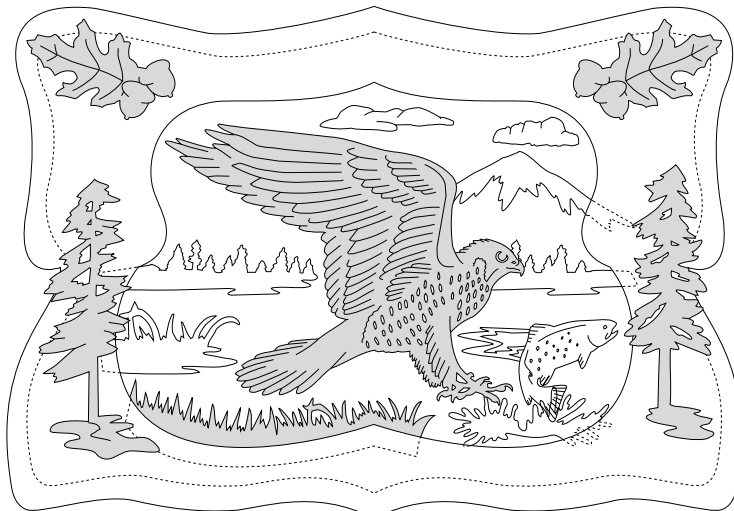

**Peregrine Falcon**

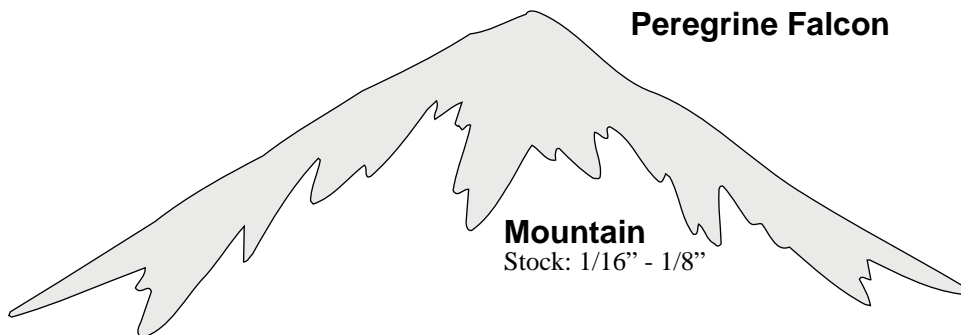

**Mountain**  
Stock: 1/16" - 1/8"

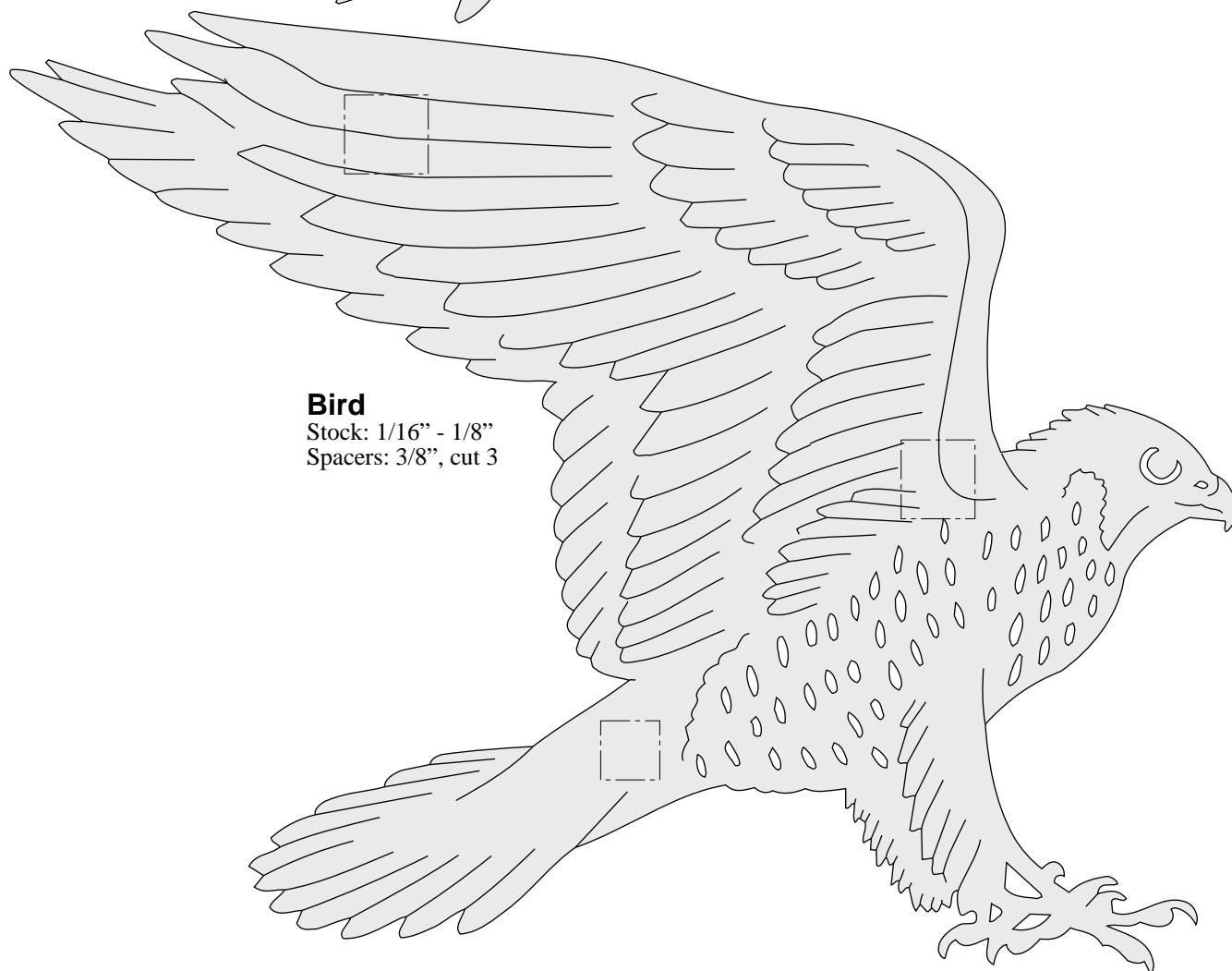

**Bird**  
Stock: 1/16" - 1/8"  
Spacers: 3/8", cut 3

**Frame & Back**

Stock: 1/8" - 1/4", cut 1 each  
Left side

3/8" Frame  
spacer  
location

Pattern overlap line

Pattern overlap line

Cut 6 spacer blocks from  
3/8" thick material to  
separate Frame from Back.

Right side

Cut on dashed  
line for Back

Cut on solid line  
for Frame only.

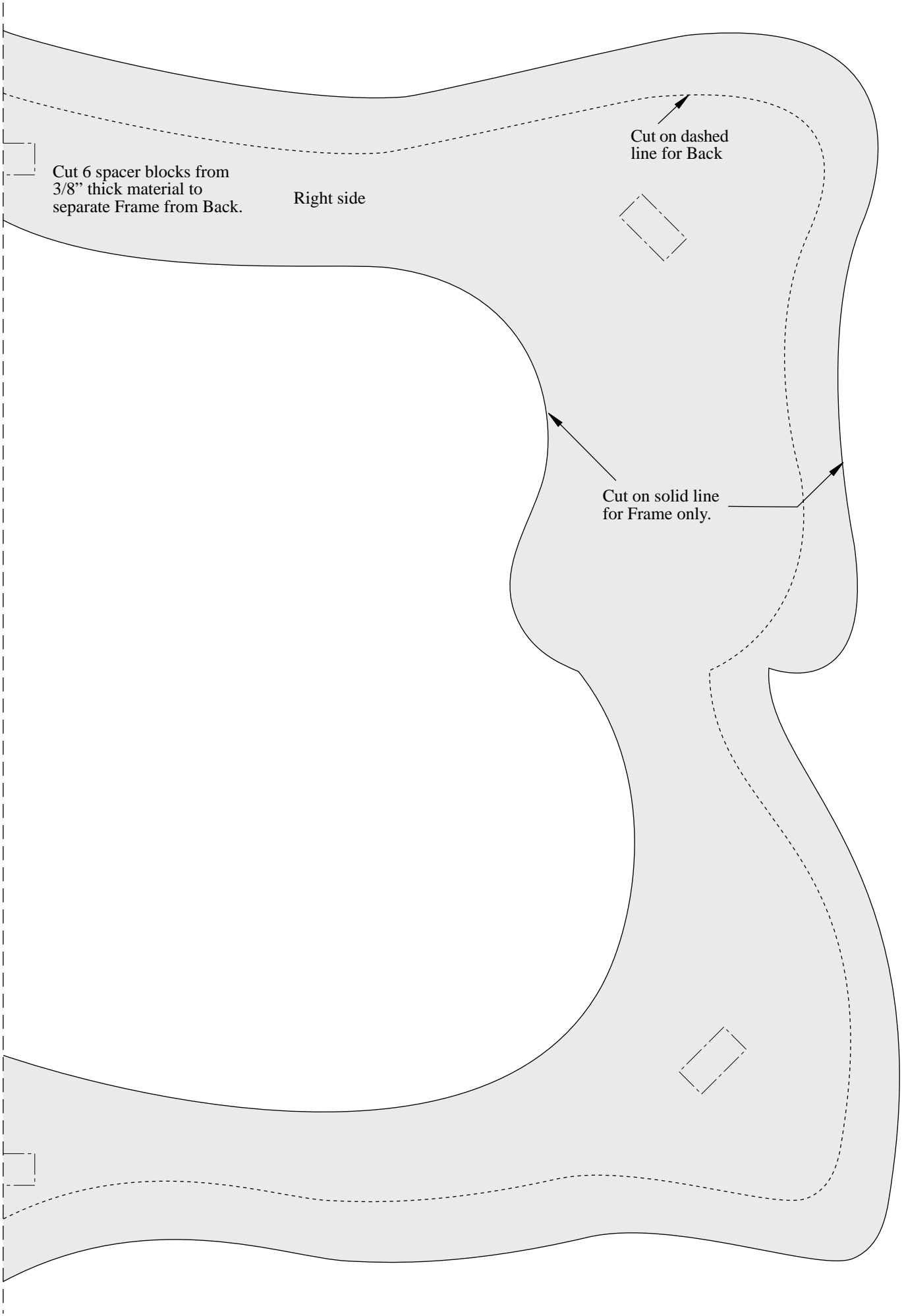

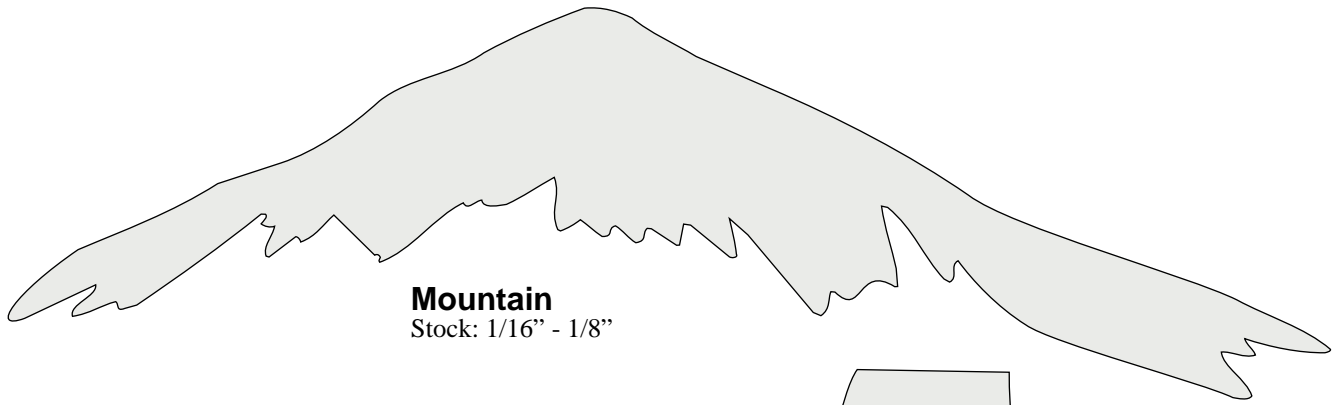

**Mountain**  
Stock: 1/16" - 1/8"

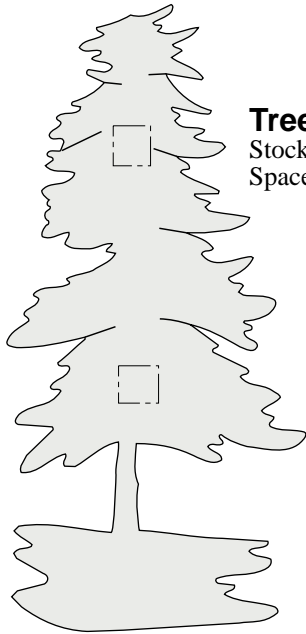

**Tree**  
Stock: 1/16" - 1/8"  
Spacers: 1/8", cut 2

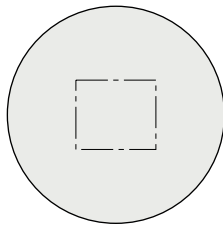

**Moon**  
Stock: 1/16" - 1/8"  
Spacer: 1/8"

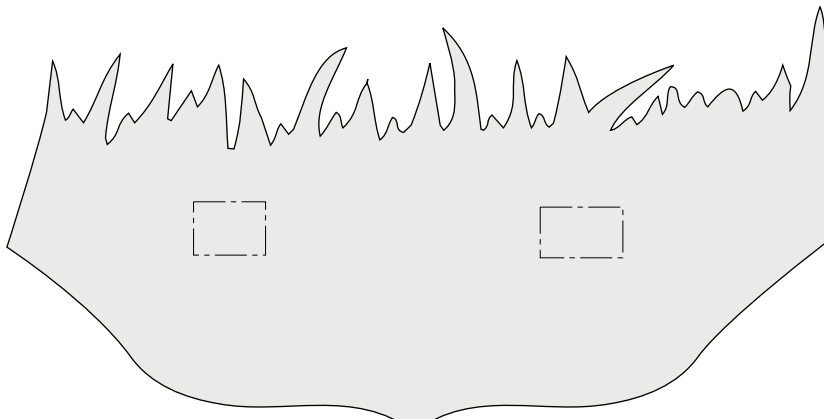

**Grass**  
Stock: 1/16" - 1/8"  
Spacers: 1/8", cut 2

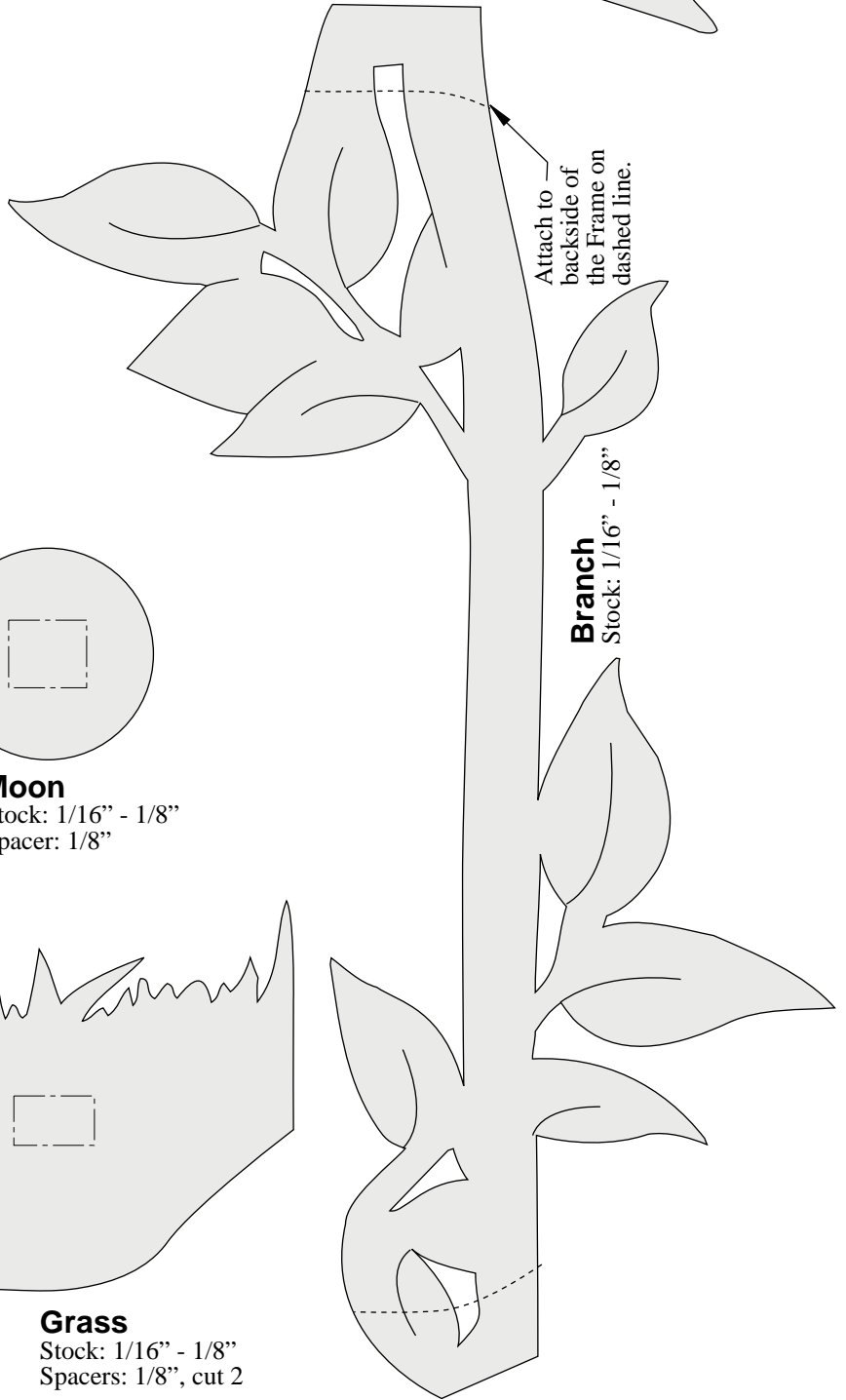

Attach to  
backside of  
the Frame on  
the dashed line.

**Branch**  
Stock: 1/16" - 1/8"

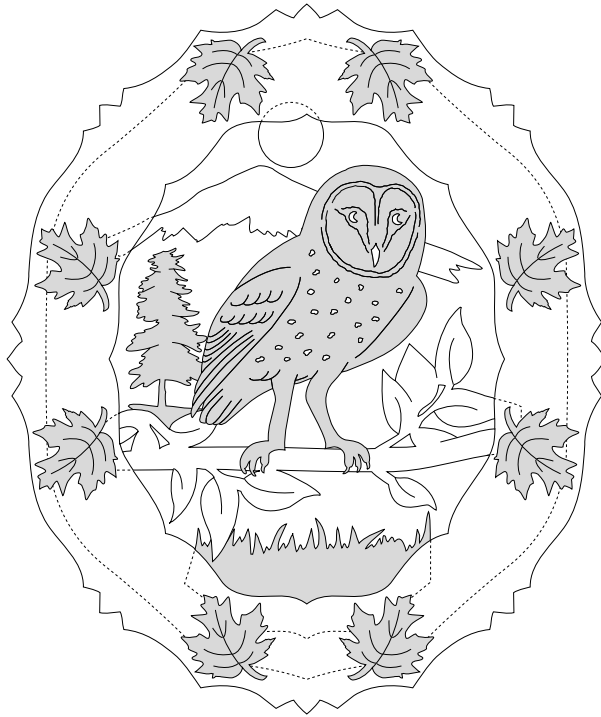

**Barn Owl**

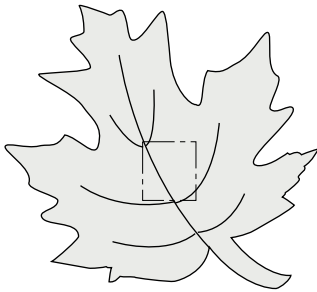

**Leaf**

Stock: 1/16" - 1/8", cut 8  
Spacers: 1/8", cut 8

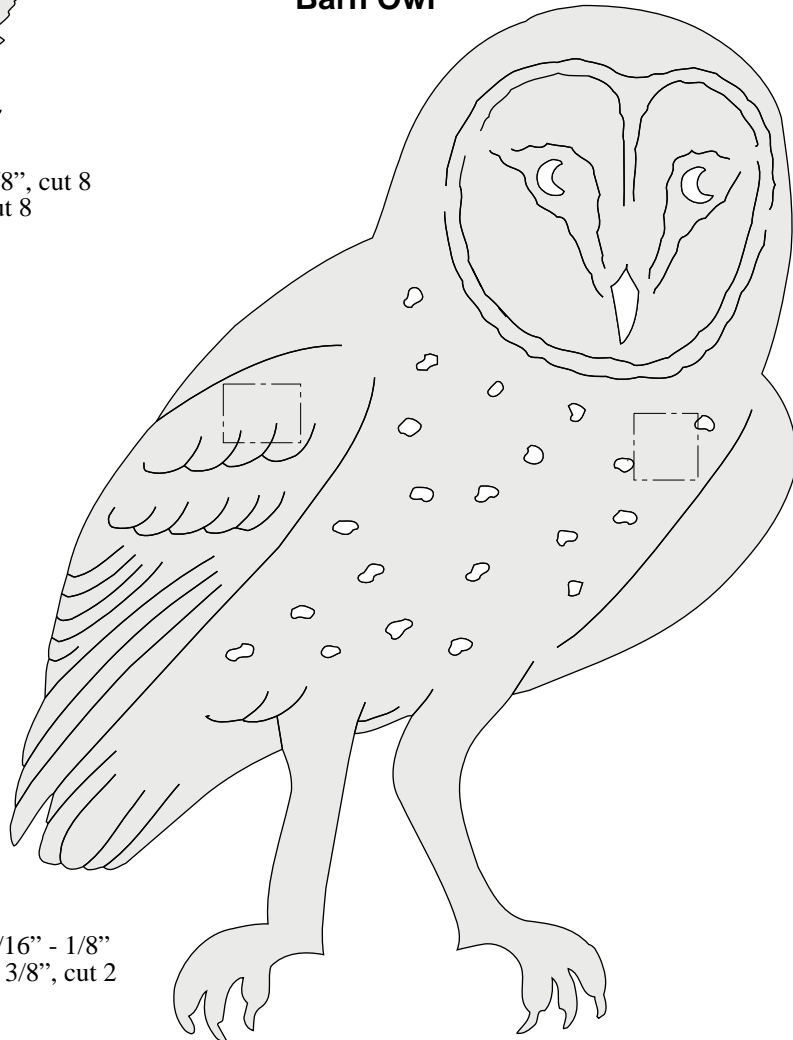

**Bird**

Stock: 1/16" - 1/8"  
Spacers: 3/8", cut 2

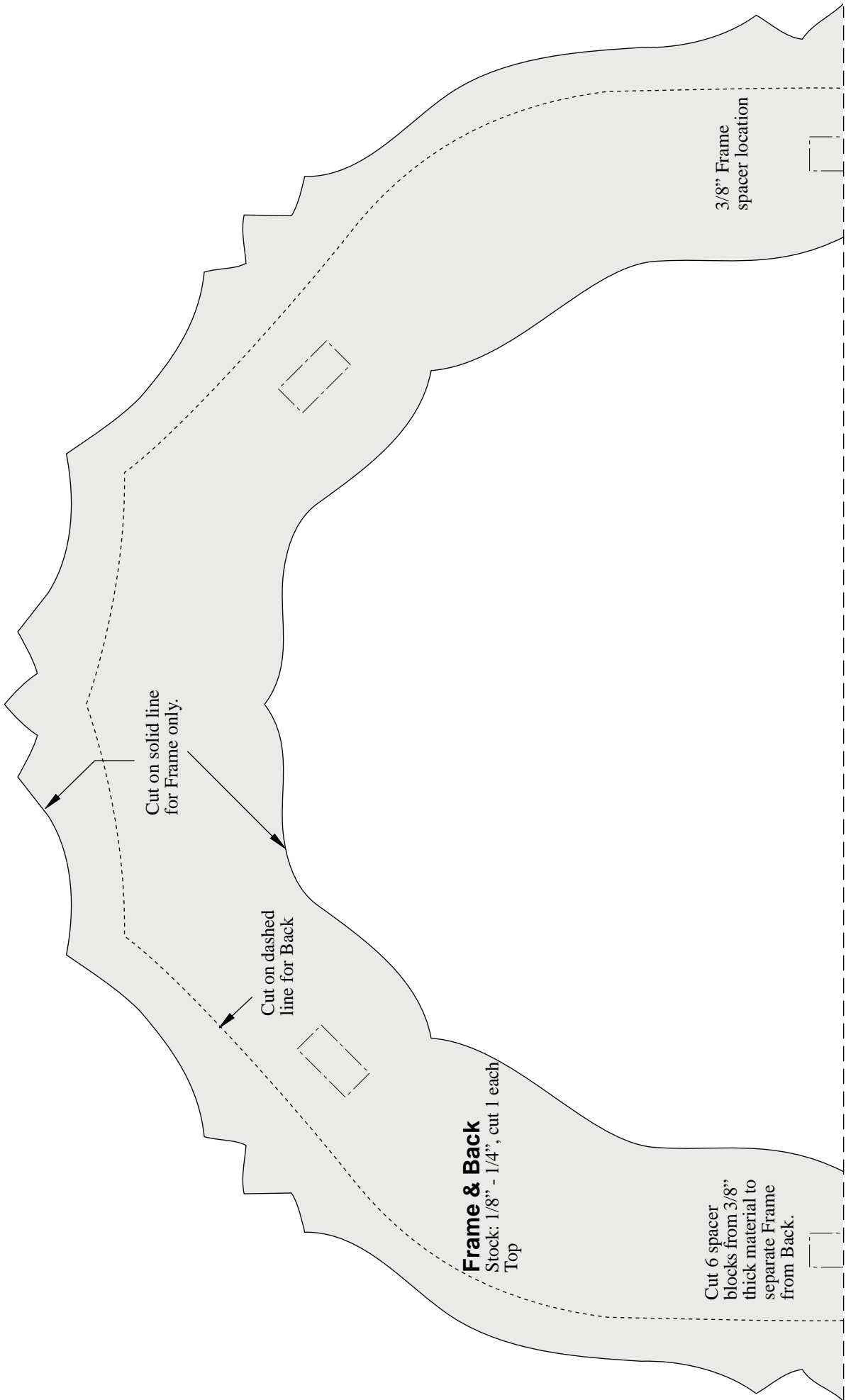

Cut on solid line  
for Frame only.

Cut on dashed  
line for Back

**Frame & Back**  
Stock: 1/8" - 1/4", cut 1 each  
Top

Cut 6 spacer  
blocks from 3/8"  
thick material to  
separate Frame  
from Back.

3/8" Frame  
spacer location

Pattern overlap line



Pattern overlap line

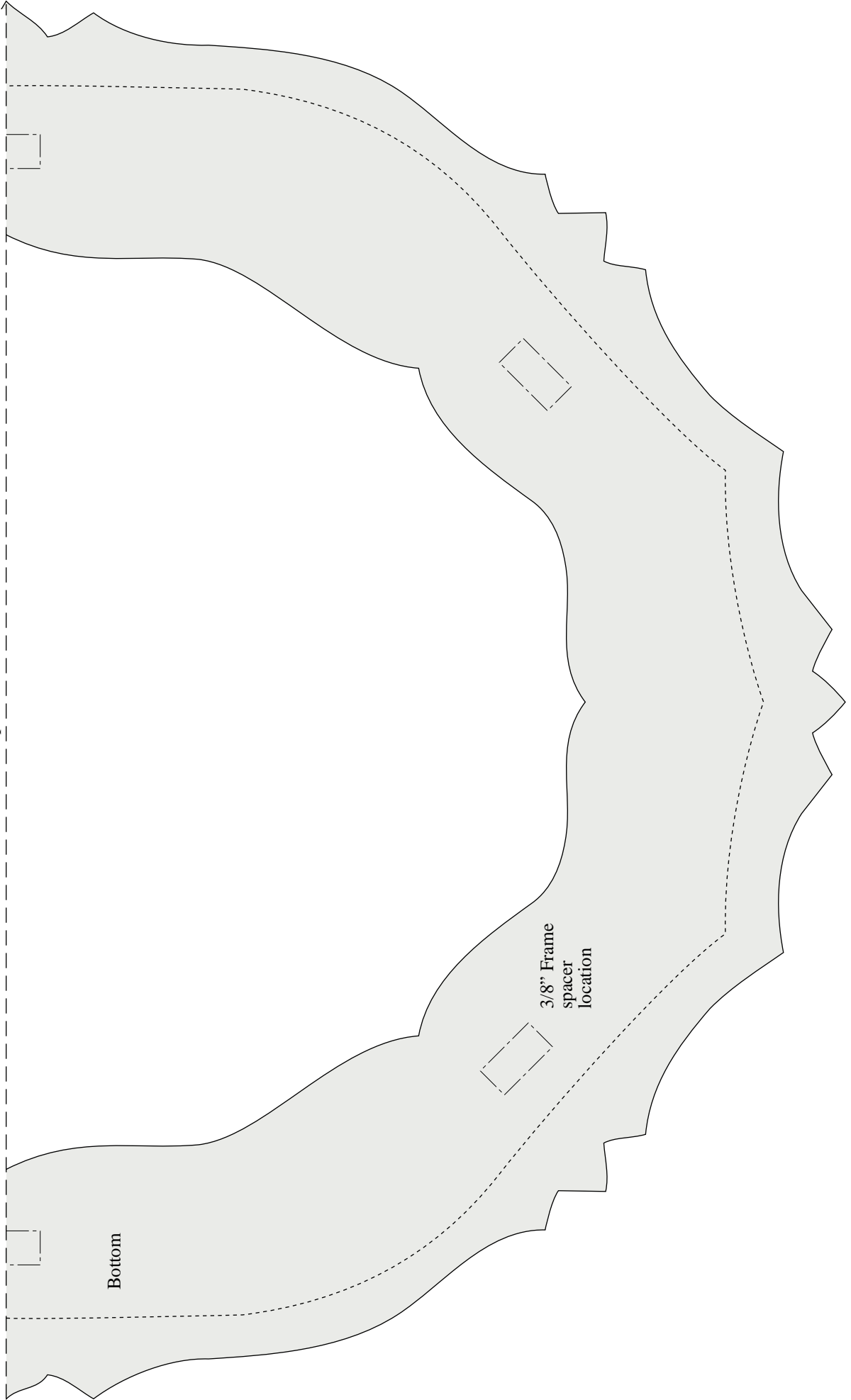

Bottom

3/8" Frame  
spacer  
location

**Top Branch**  
Stock: 1/16" - 1/8"

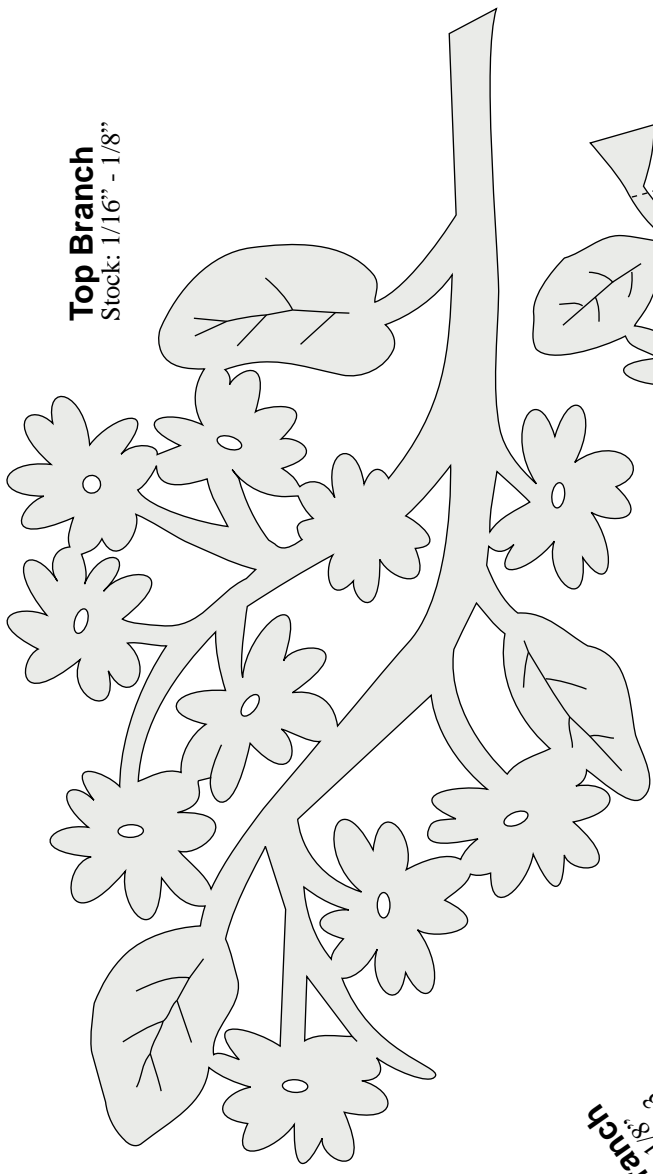

**Middle Branch**  
Stock: 1/16" - 1/8"  
Attach to back of  
Frame at dashed lines.

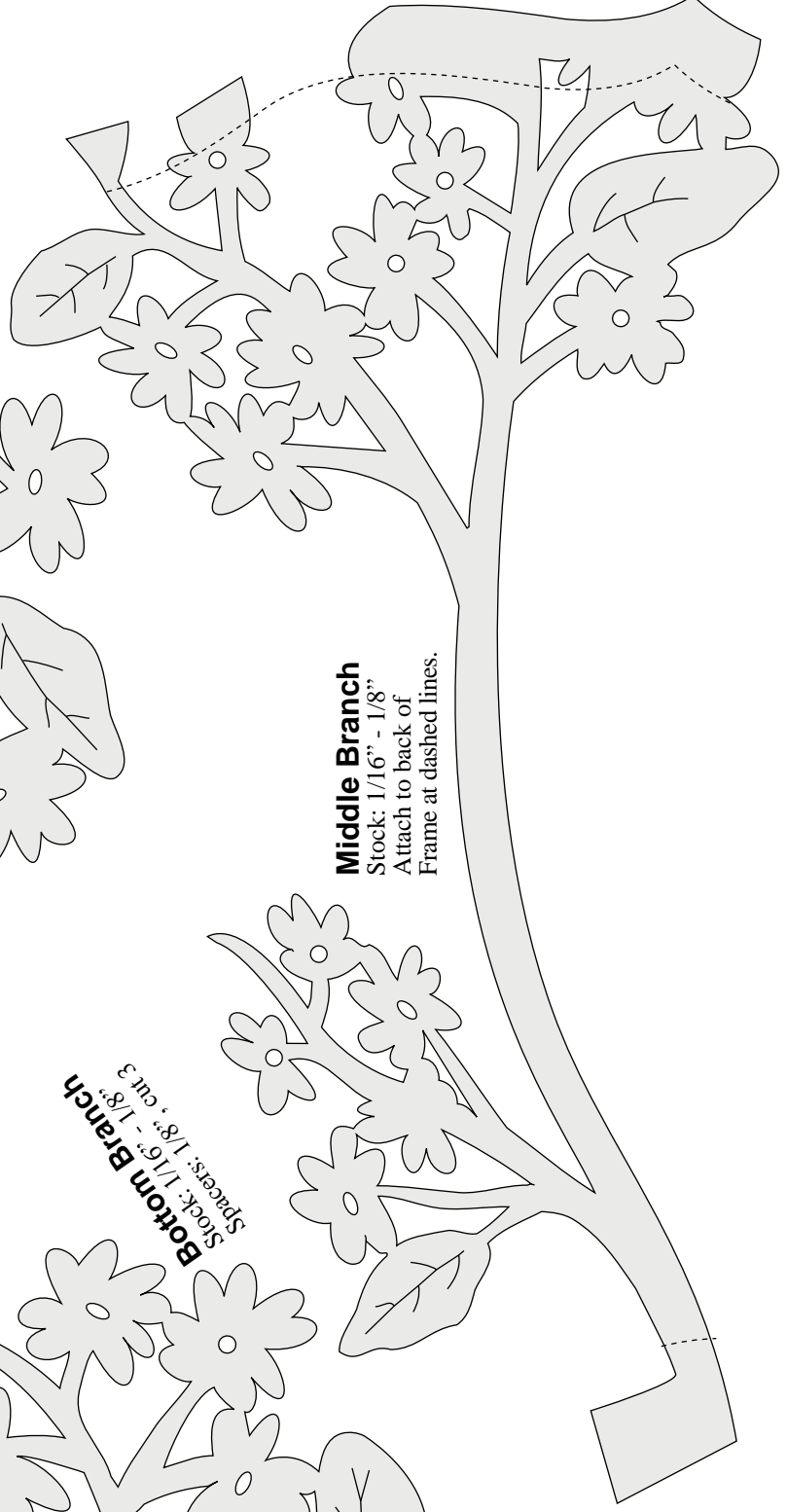

**Bottom Branch**  
Stock: 1/16" - 1/8"  
Spacers: 1/8" - cut 3

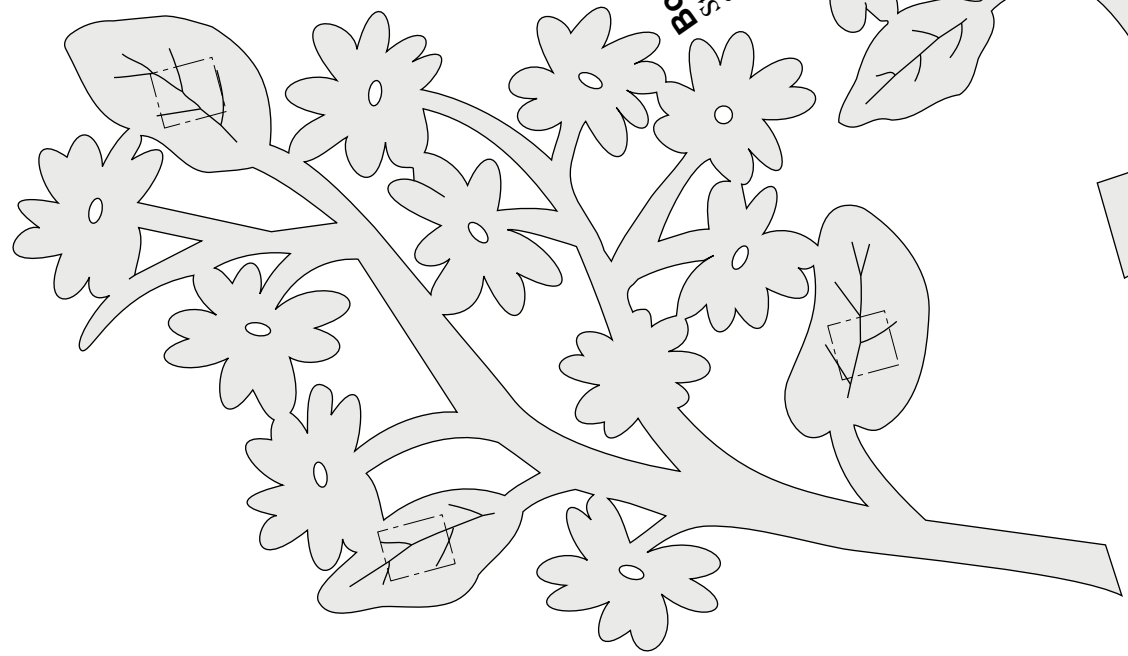



**Long-Eared Owl**

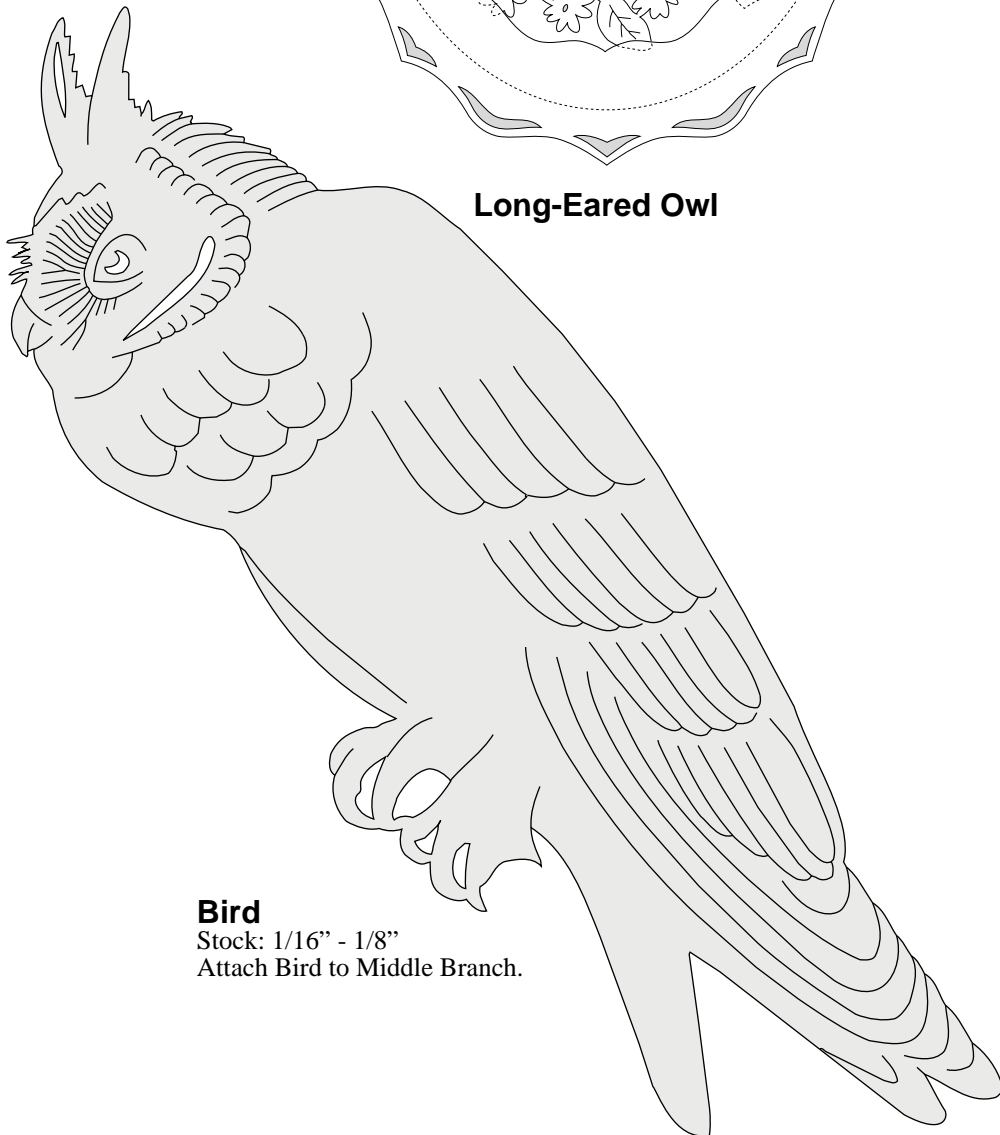

**Bird**  
Stock: 1/16" - 1/8"  
Attach Bird to Middle Branch.

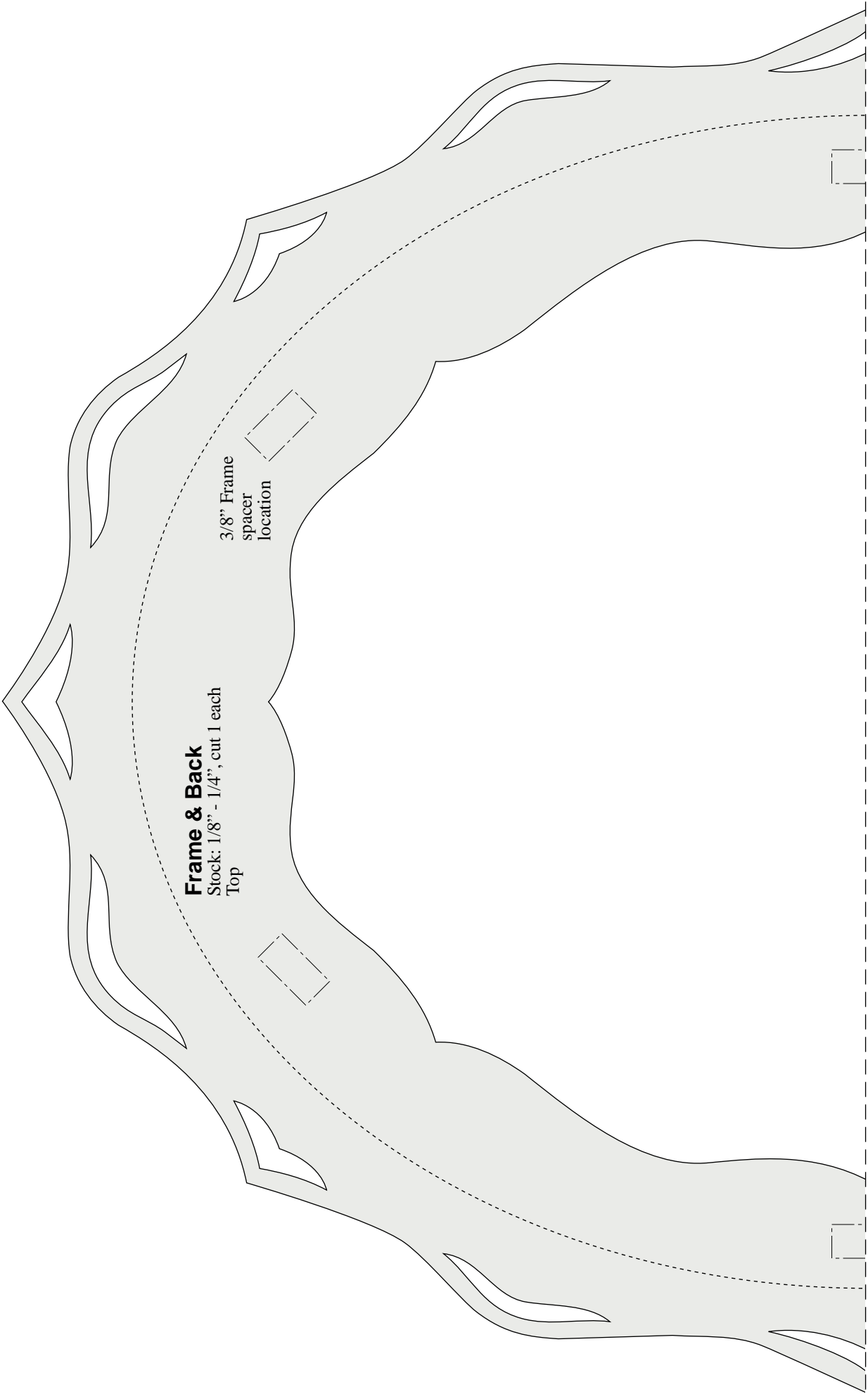

**Frame & Back**

Stock: 1/8" - 1/4", cut 1 each  
Top

3/8" Frame  
spacer  
location

Pattern overlap line

Pattern overlap line

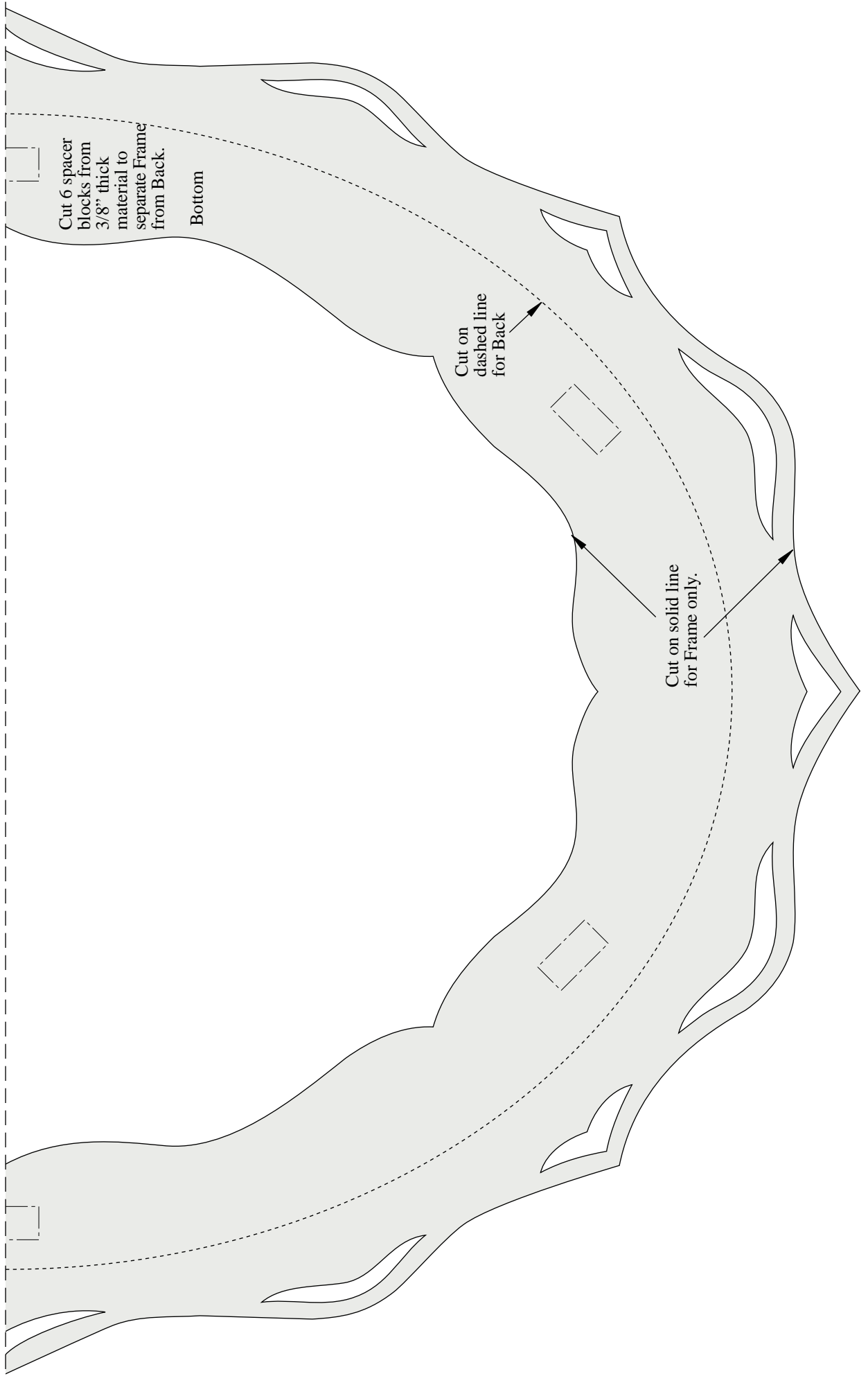

Cut 6 spacer blocks from 3/8" thick material to separate Frame from Back.

Bottom

Cut on dashed line for Back

Cut on solid line for Frame only.

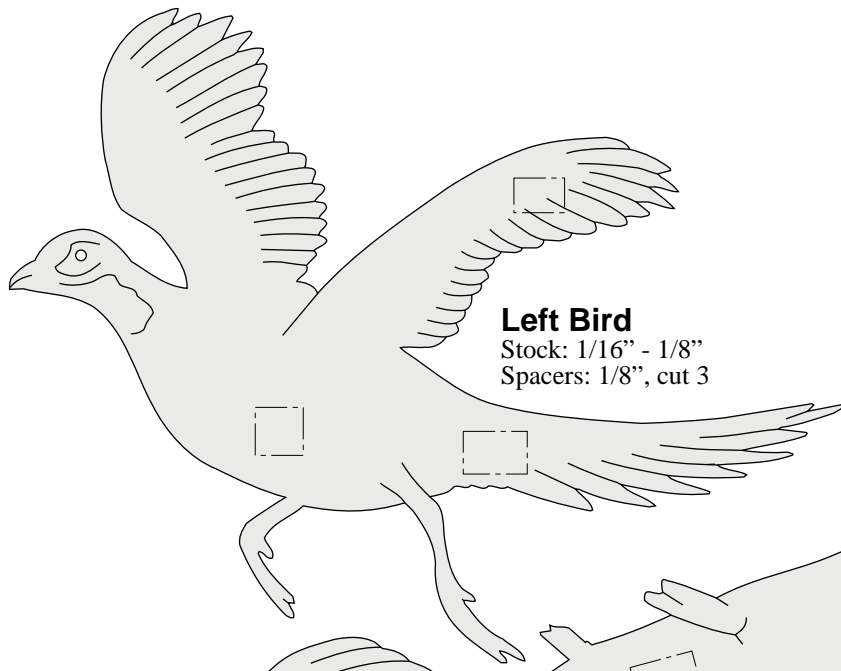

**Left Bird**  
Stock: 1/16" - 1/8"  
Spacers: 1/8", cut 3

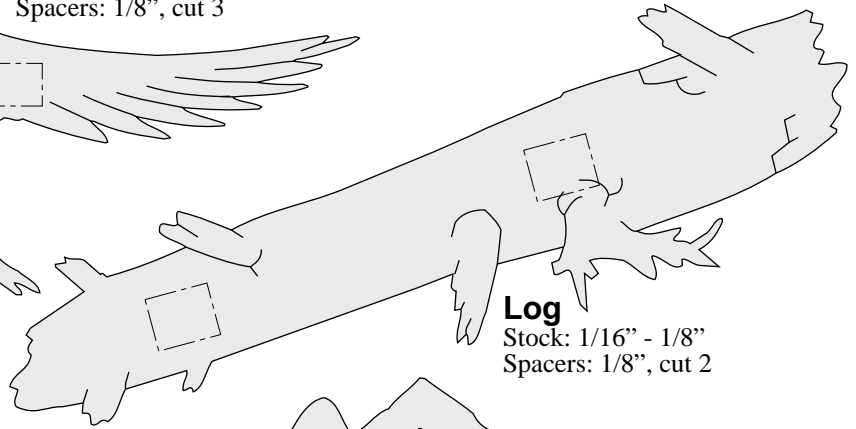

**Log**  
Stock: 1/16" - 1/8"  
Spacers: 1/8", cut 2

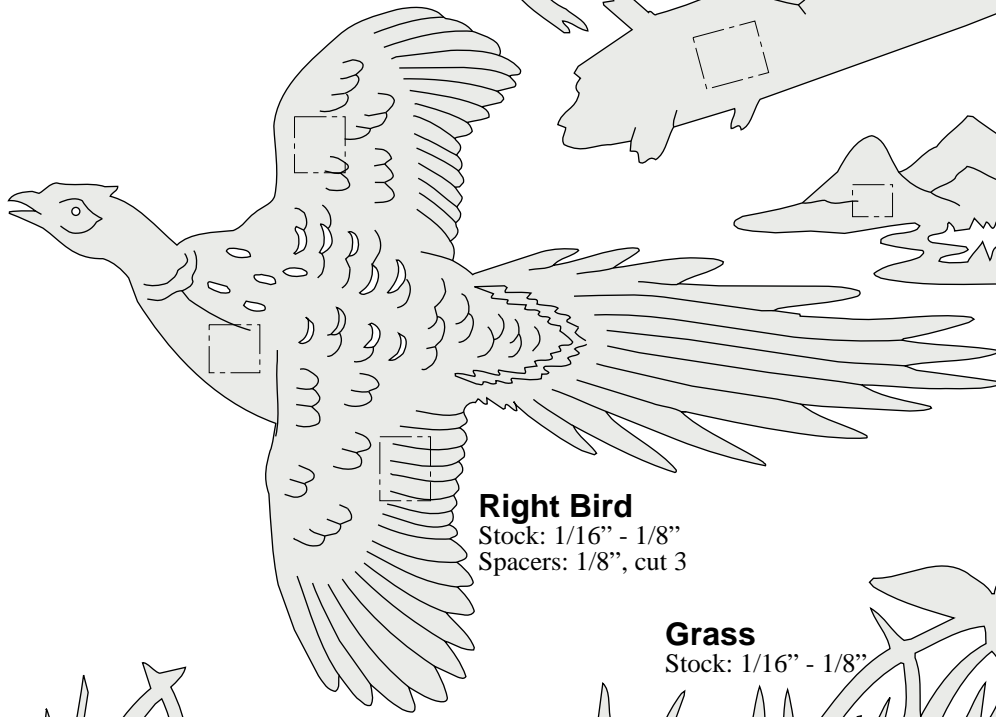

**Right Bird**  
Stock: 1/16" - 1/8"  
Spacers: 1/8", cut 3

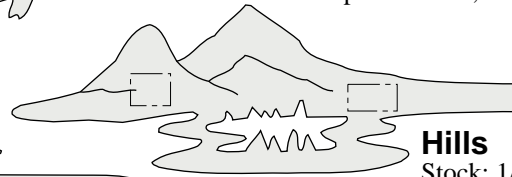

**Hills**  
Stock: 1/16" - 1/8"  
Spacers: 1/8", cut 2

**Grass**  
Stock: 1/16" - 1/8"

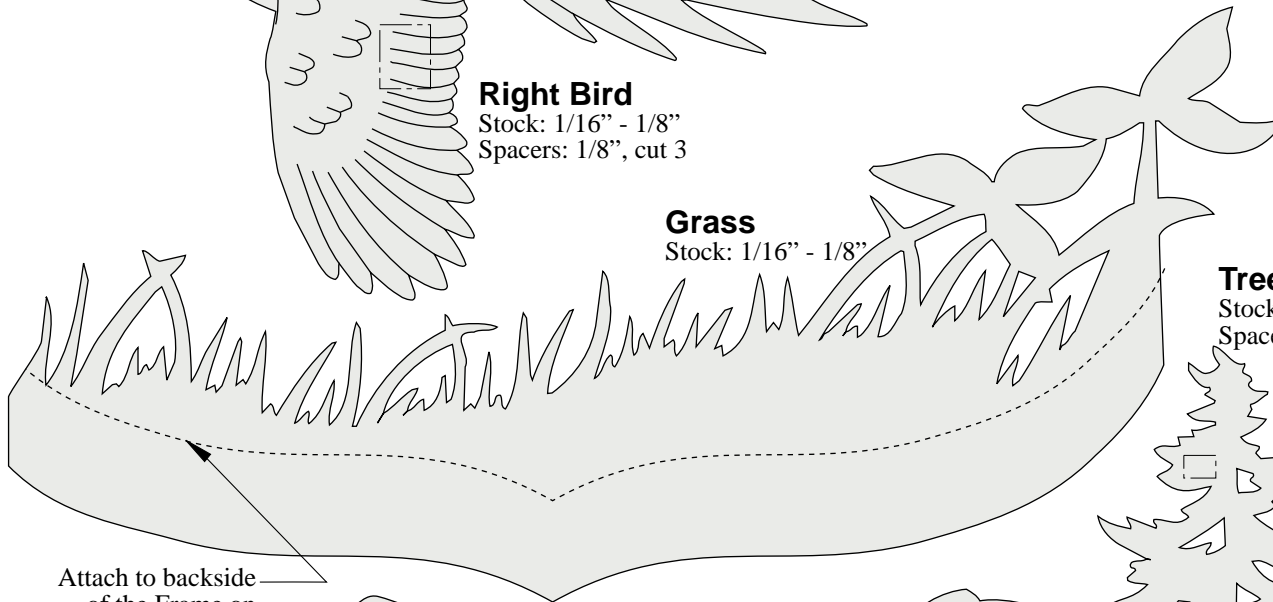

Attach to backside  
of the Frame on  
dashed line.

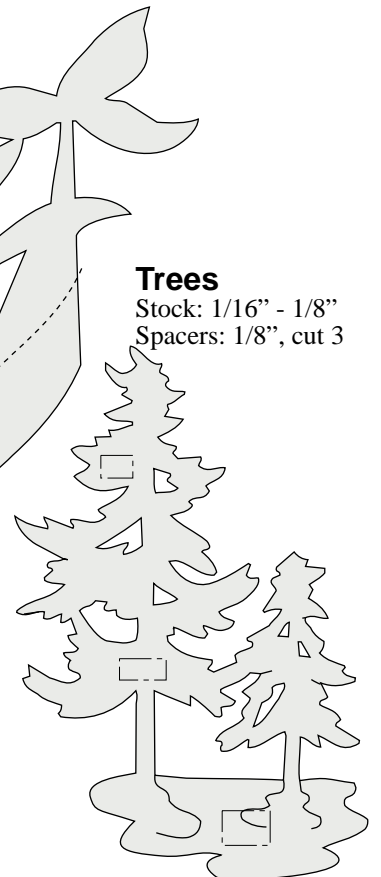

**Trees**  
Stock: 1/16" - 1/8"  
Spacers: 1/8", cut 3

**Leaves**  
Stock: 1/16" - 1/8", cut 3  
Spacers: 1/8", cut 6

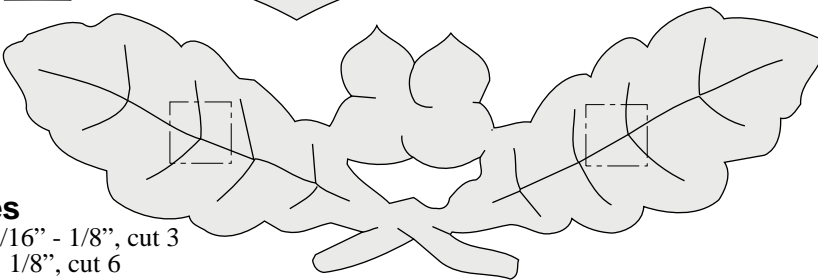

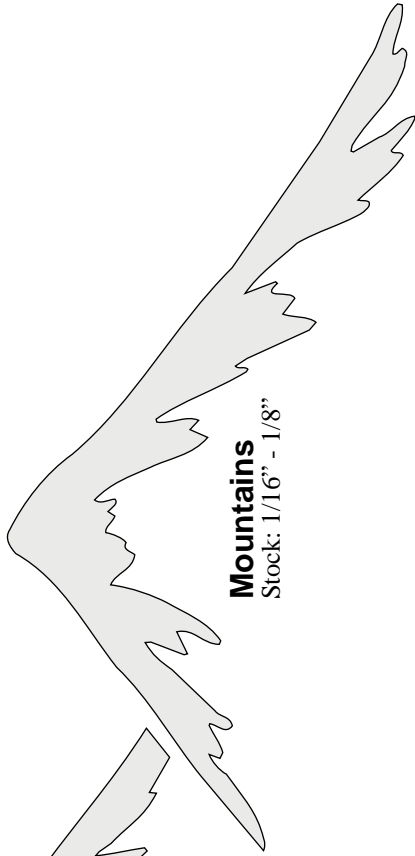

**Mountains**  
Stock: 1/16" - 1/8"

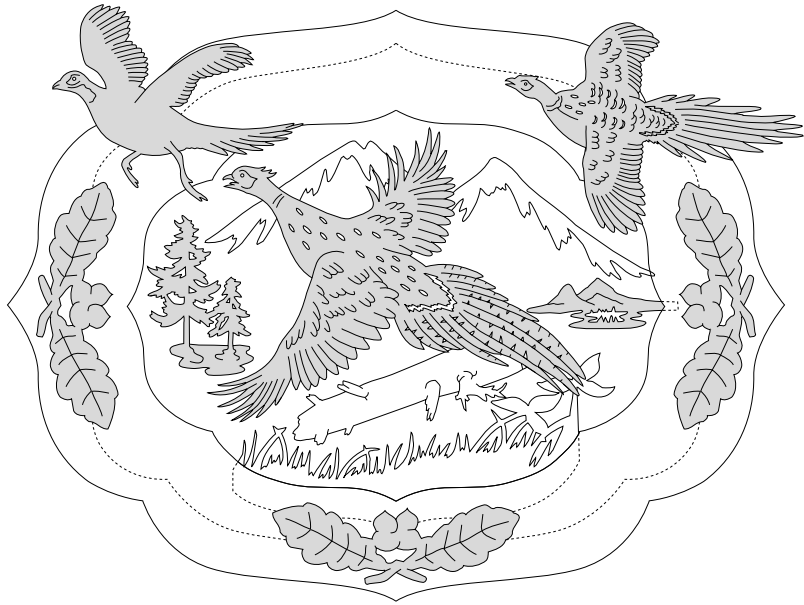

**Ring-Necked Pheasant**

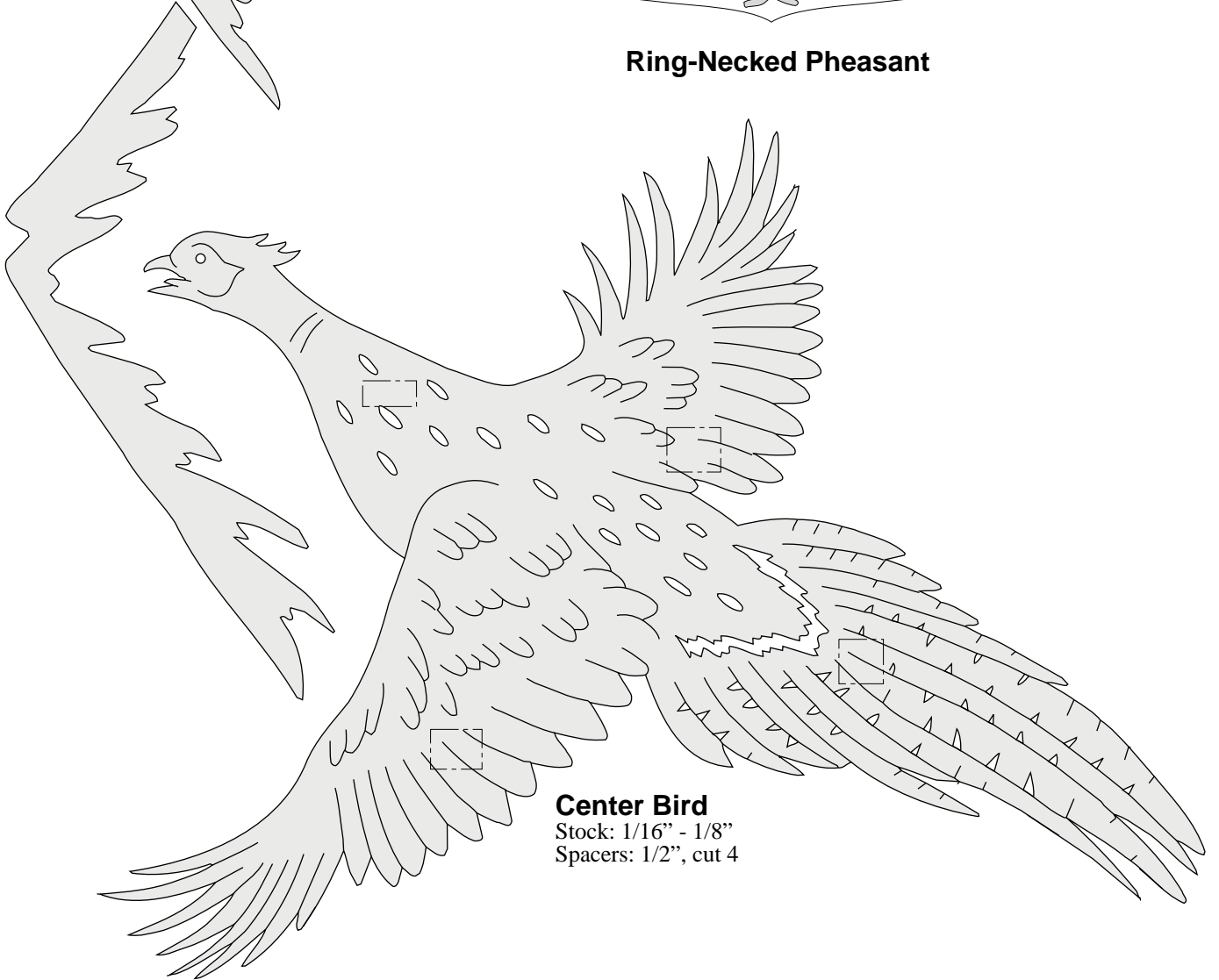

**Center Bird**  
Stock: 1/16" - 1/8"  
Spacers: 1/2", cut 4

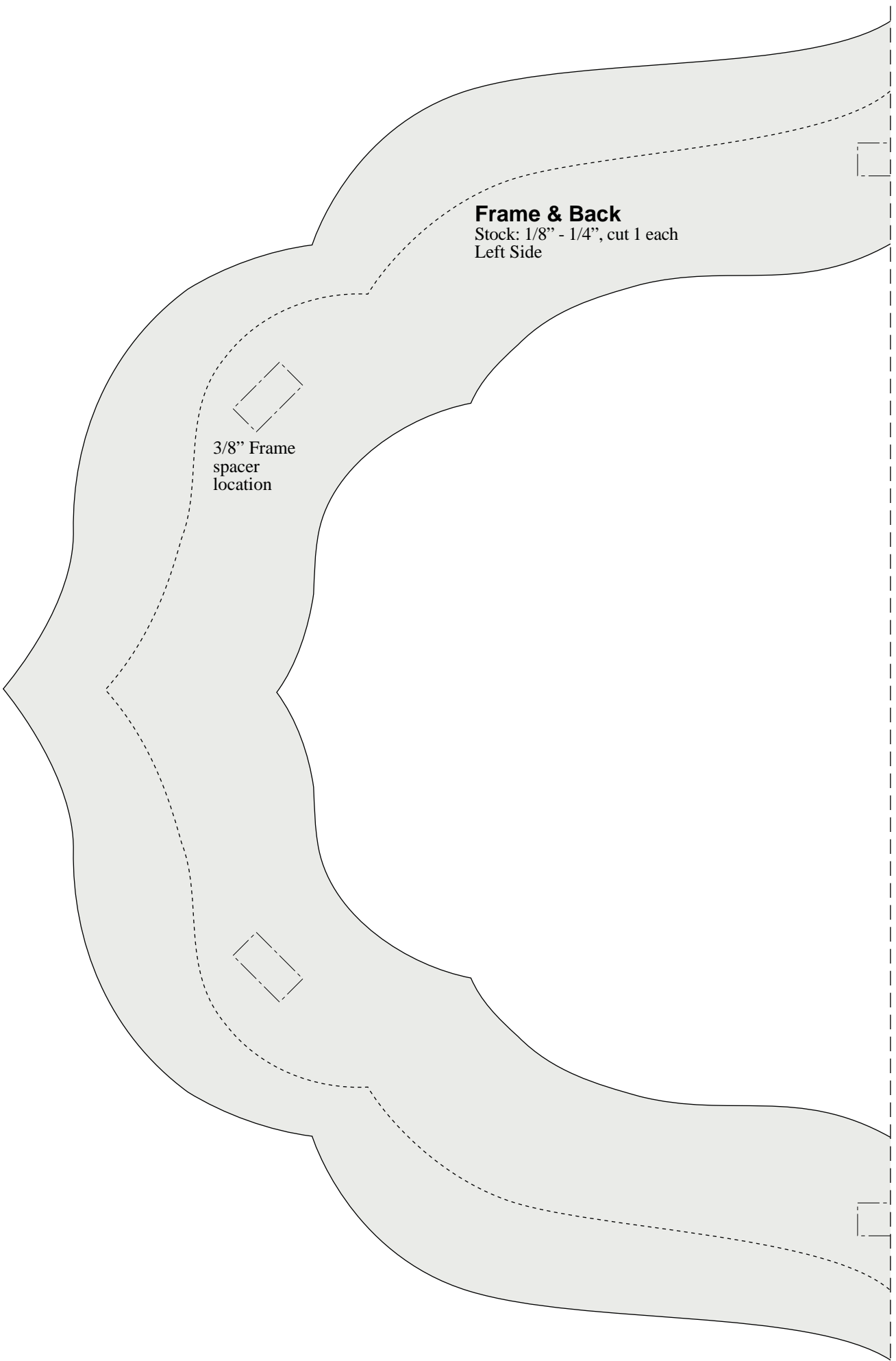

**Frame & Back**

Stock: 1/8" - 1/4", cut 1 each  
Left Side

3/8" Frame  
spacer  
location

Pattern overlap line



Pattern overlap line

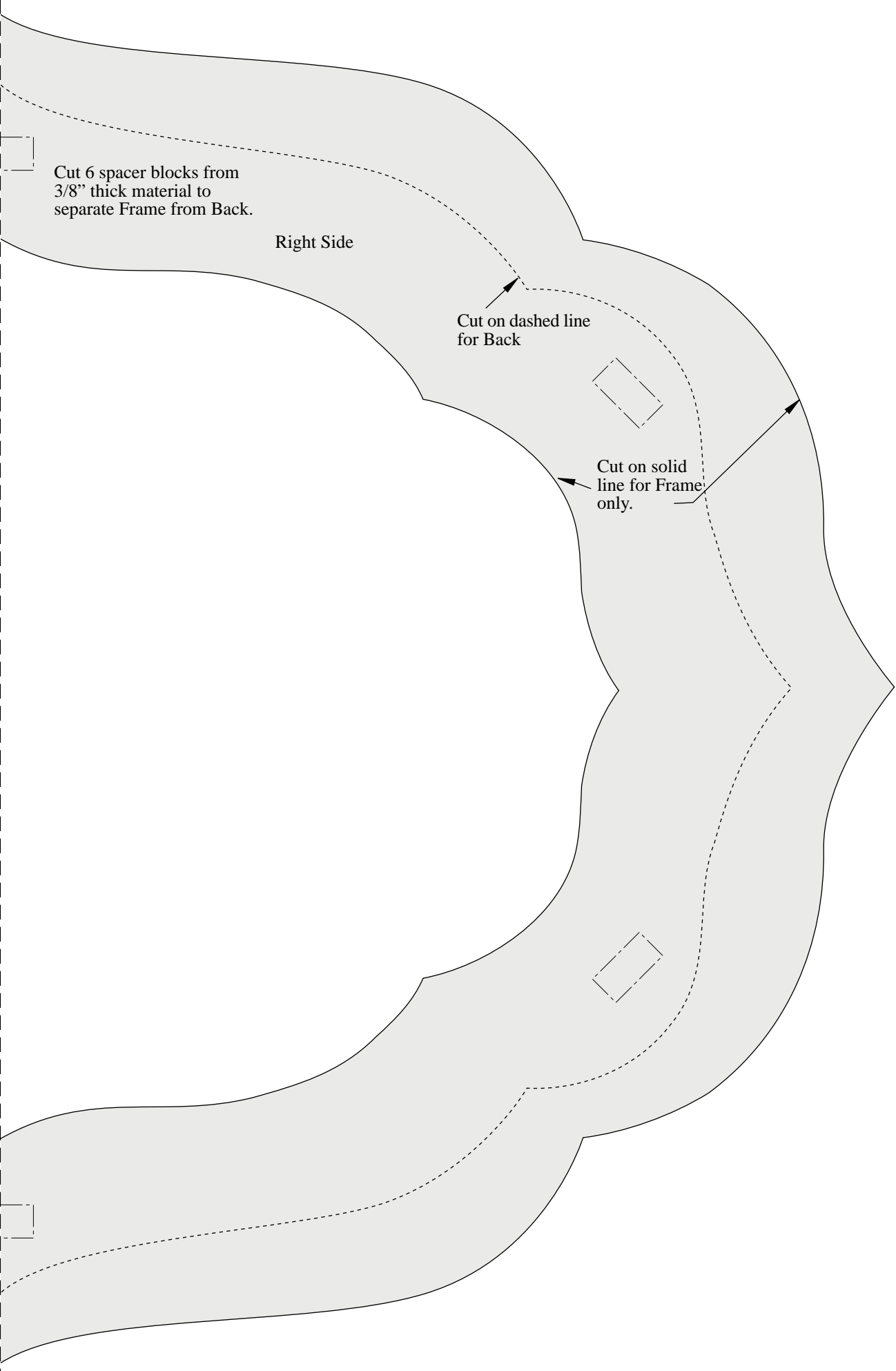

Cut 6 spacer blocks from  
3/8" thick material to  
separate Frame from Back.

Right Side

Cut on dashed line  
for Back

Cut on solid  
line for Frame  
only.

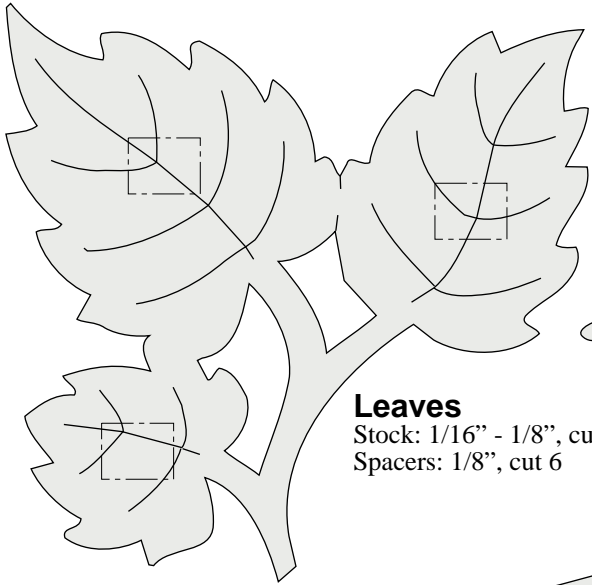

**Leaves**  
Stock: 1/16" - 1/8", cut 2  
Spacers: 1/8", cut 6

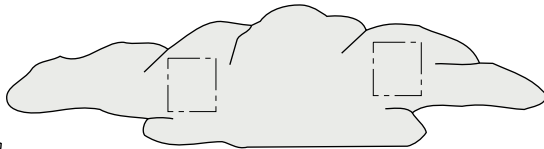

**Cloud**  
Stock: 1/16" - 1/8"  
Spacers: 1/8", cut 2



**Sun**  
Stock: 1/16" - 1/8"

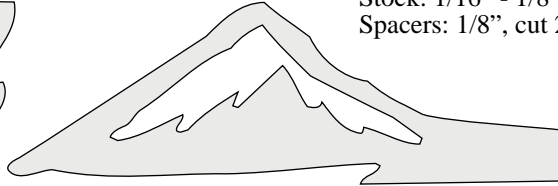

**Right Mountain**  
Stock: 1/16" - 1/8"

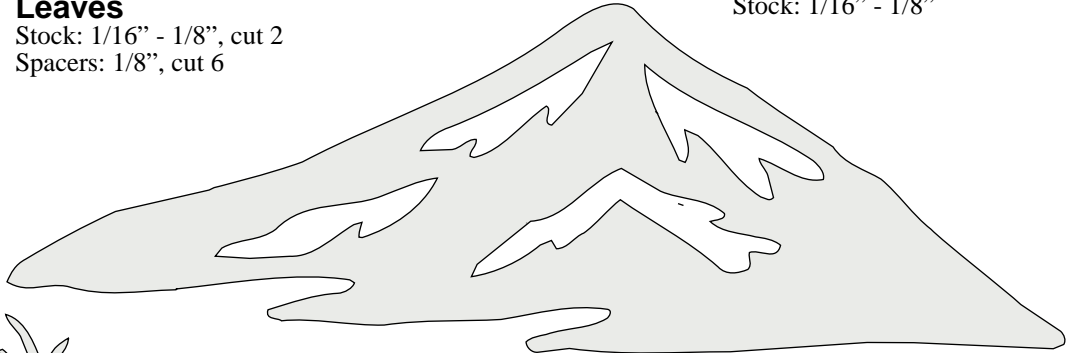

**Left Mountain**  
Stock: 1/16" - 1/8"

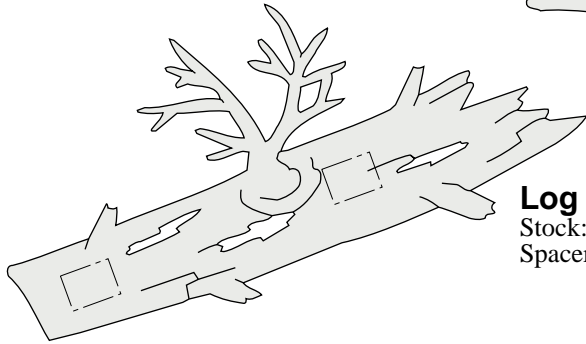

**Log**  
Stock: 1/16" - 1/8"  
Spacers: 1/4", cut 2

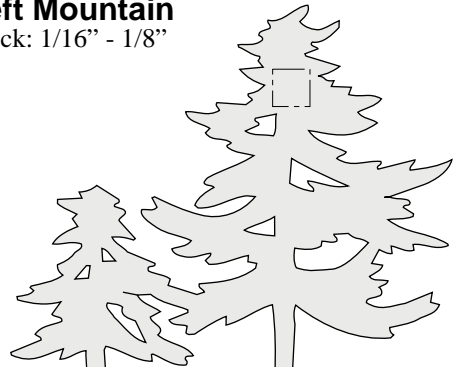

**Trees**  
Stock: 1/16" - 1/8"  
Spacers: 1/4", cut 3

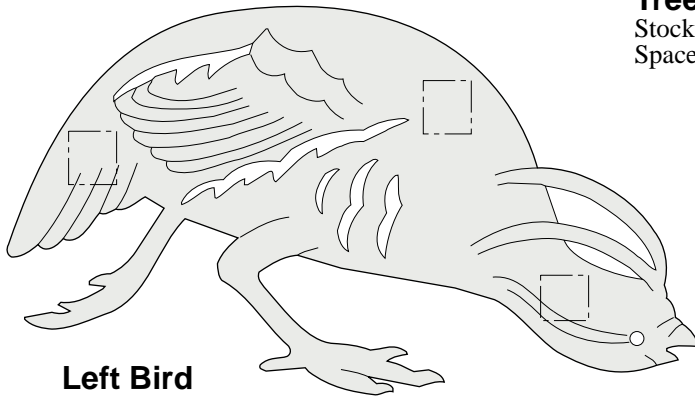

**Left Bird**  
Stock: 1/16" - 1/8"  
Spacers: 1/8", cut 3

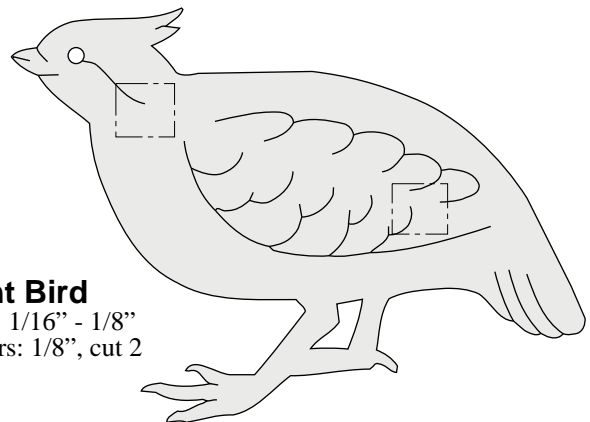
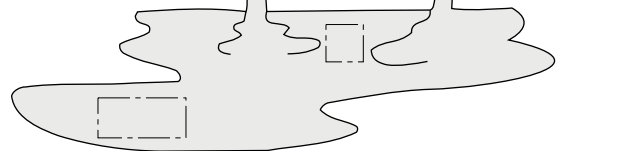

**Right Bird**  
Stock: 1/16" - 1/8"  
Spacers: 1/8", cut 2

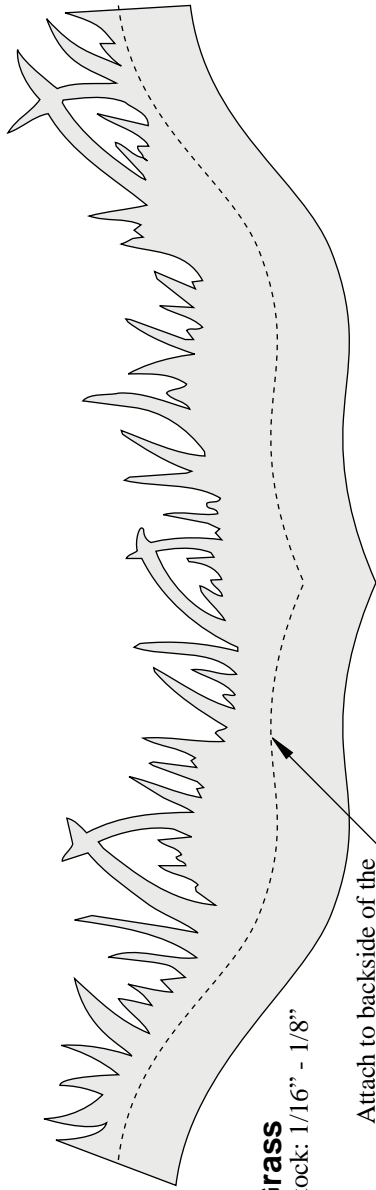

**Grass**  
Stock: 1/16" - 1/8"

Attach to backside of the  
Frame on dashed line.



**Mountain Quail**

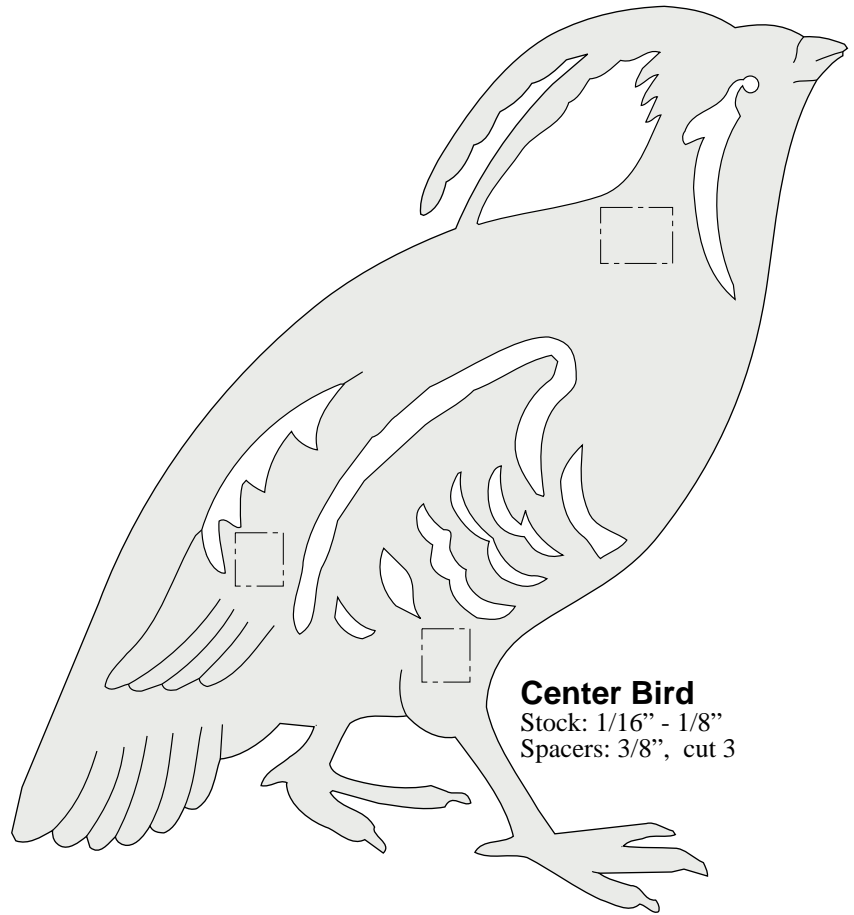

**Center Bird**  
Stock: 1/16" - 1/8"  
Spacers: 3/8", cut 3

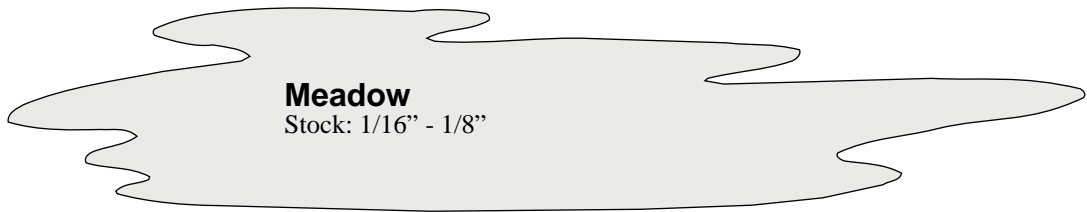

**Meadow**  
Stock: 1/16" - 1/8"



3/8" Frame  
spacer  
location

**Frame & Back**

Stock: 1/8" - 1/4", cut 1 each  
Left side

Pattern overlap line

Pattern overlap line

Cut 6 spacer blocks from  
3/8" thick material to  
separate Frame from Back.

Right side

Cut on dashed  
line for Back

Cut on solid line  
for Frame only.



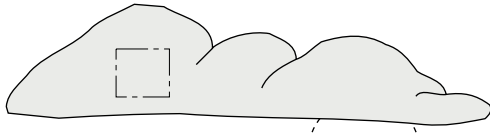

**Cloud**  
Stock: 1/16" - 1/8"  
Spacer: 1/8"

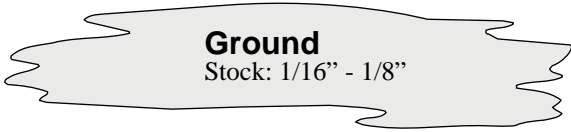

**Ground**  
Stock: 1/16" - 1/8"

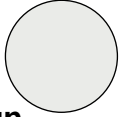

**Sun**  
Stock: 1/16" - 1/8"

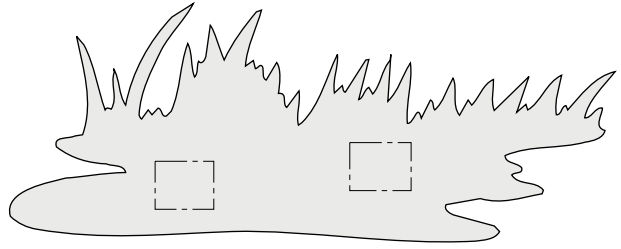

**Grass**  
Stock: 1/16" - 1/8"  
Spacers: 1/8", cut 2

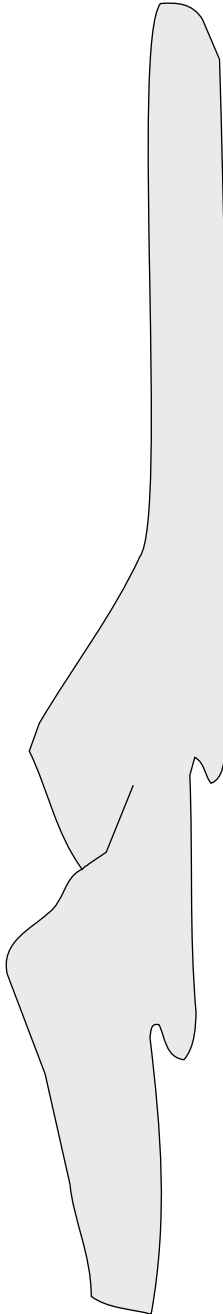

**Hills**  
Stock: 1/16" - 1/8"

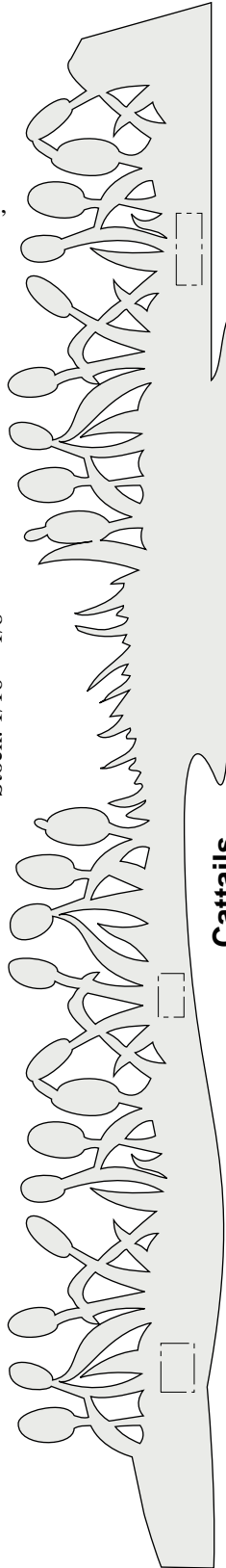

**Cattails**  
Stock: 1/16" - 1/8"  
Spacers: 1/8", cut 3

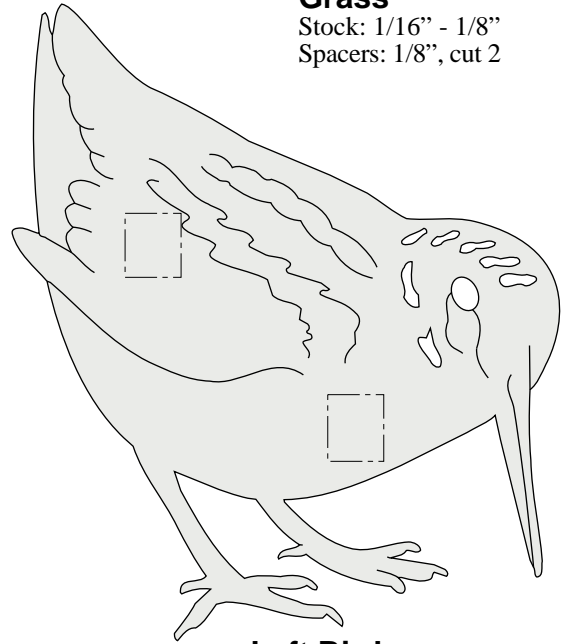

**Left Bird**  
Stock: 1/16" - 1/8"  
Spacers: 1/8", cut 2

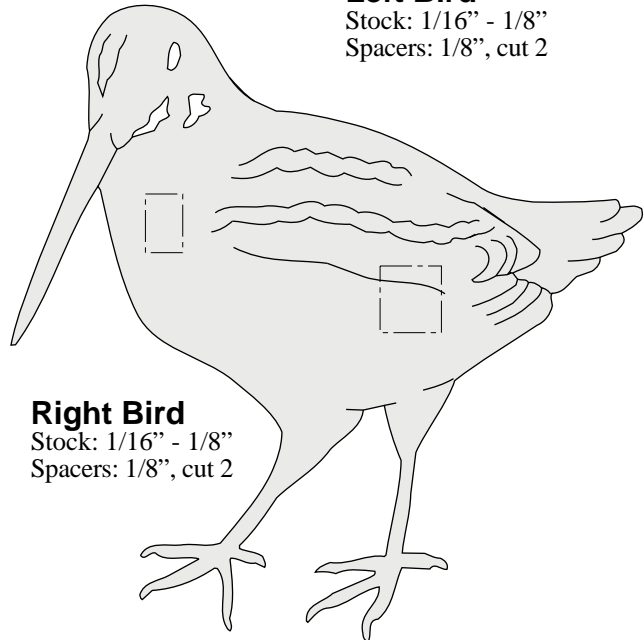

**Right Bird**  
Stock: 1/16" - 1/8"  
Spacers: 1/8", cut 2

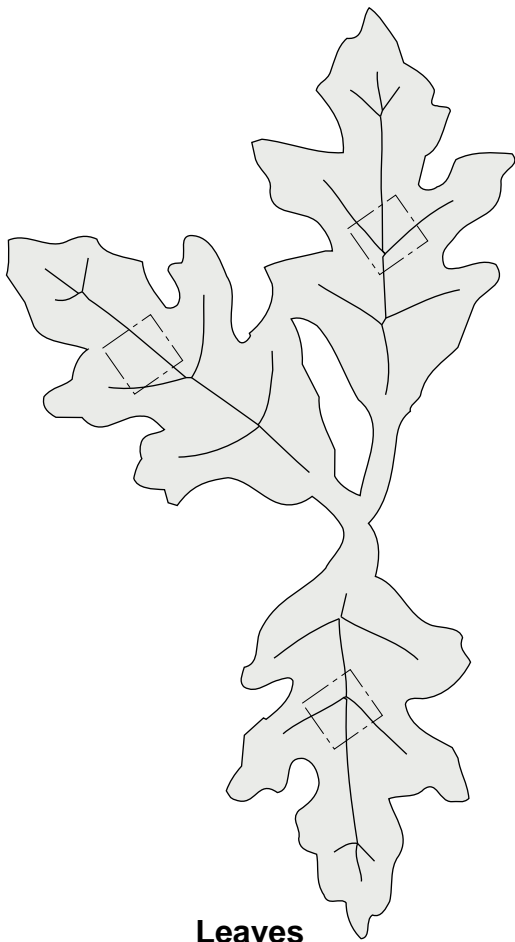

**Leaves**

Stock: 1/16" - 1/8", cut 2  
Spacers: 1/8", cut 6

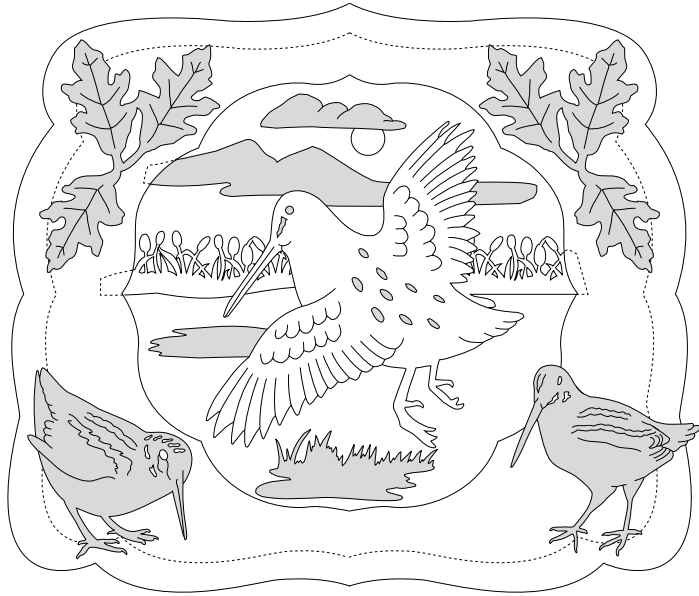

**Woodcock**

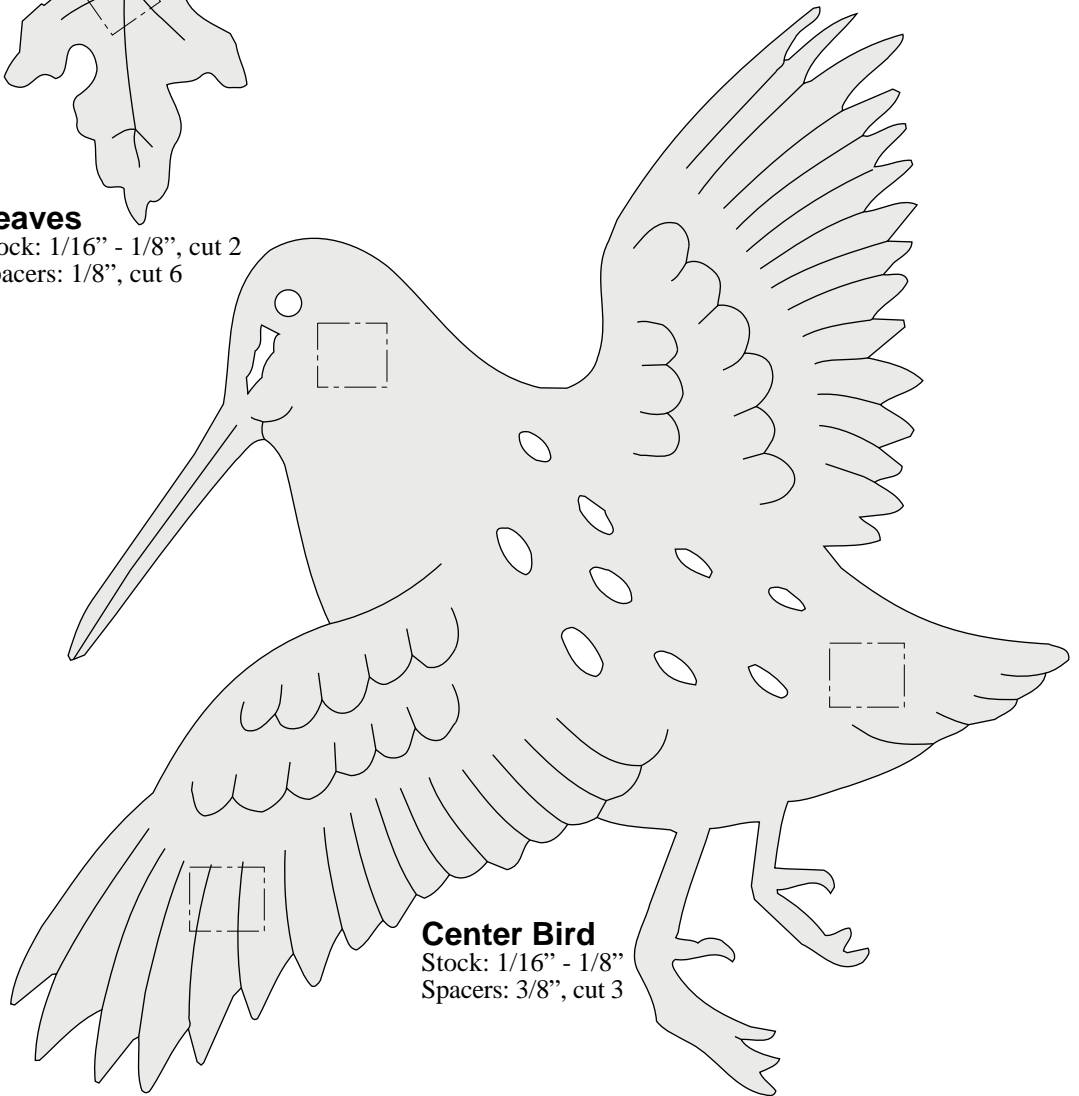

**Center Bird**

Stock: 1/16" - 1/8"  
Spacers: 3/8", cut 3

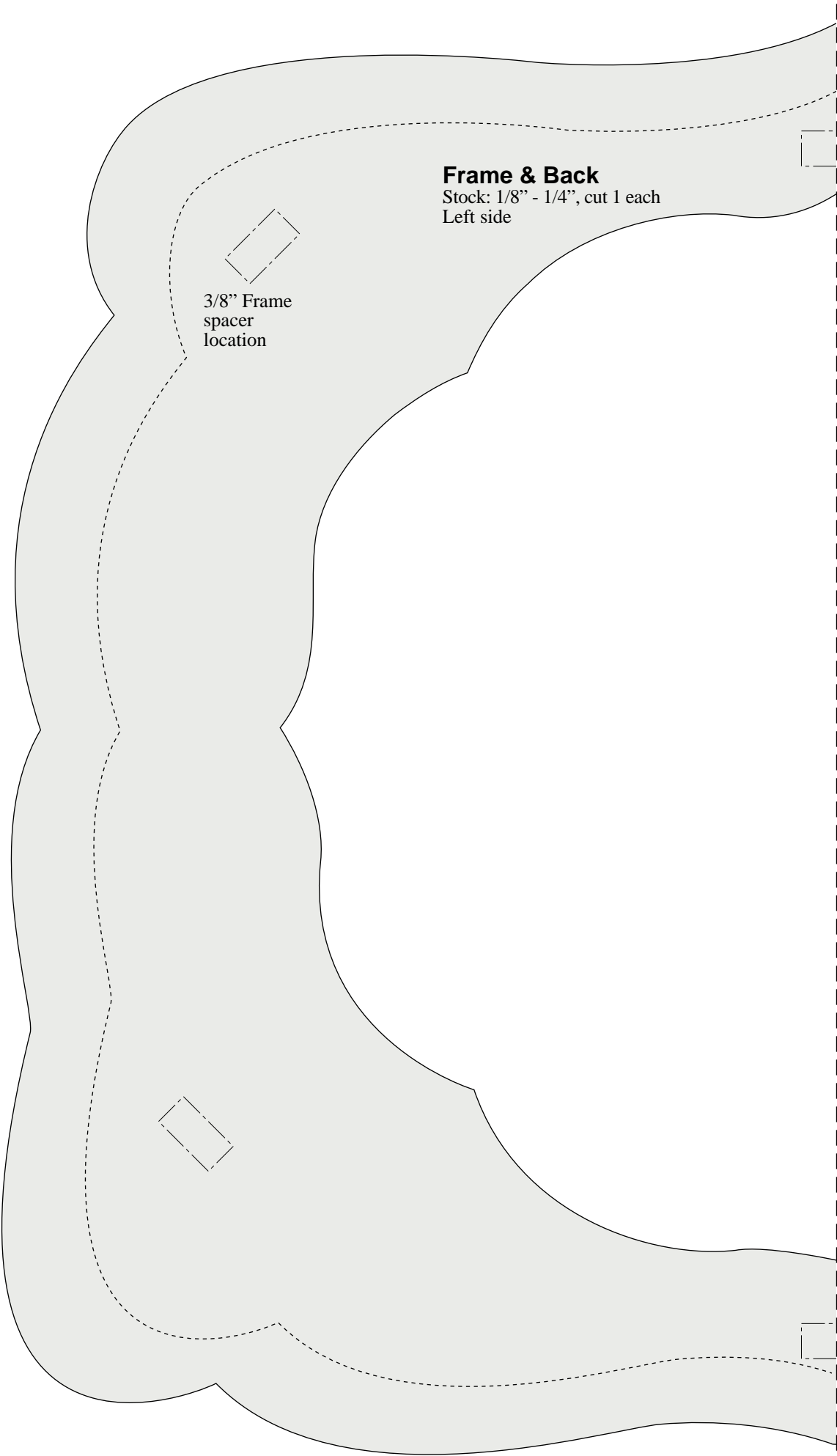

**Frame & Back**  
Stock: 1/8" - 1/4", cut 1 each  
Left side

3/8" Frame  
spacer  
location

Pattern overlap line



Pattern overlap line

Cut 6 spacer blocks from  
3/8" thick material to  
separate Frame from Back.

Right side

Cut on dashed  
line for Back

Cut on solid line  
for Frame only.

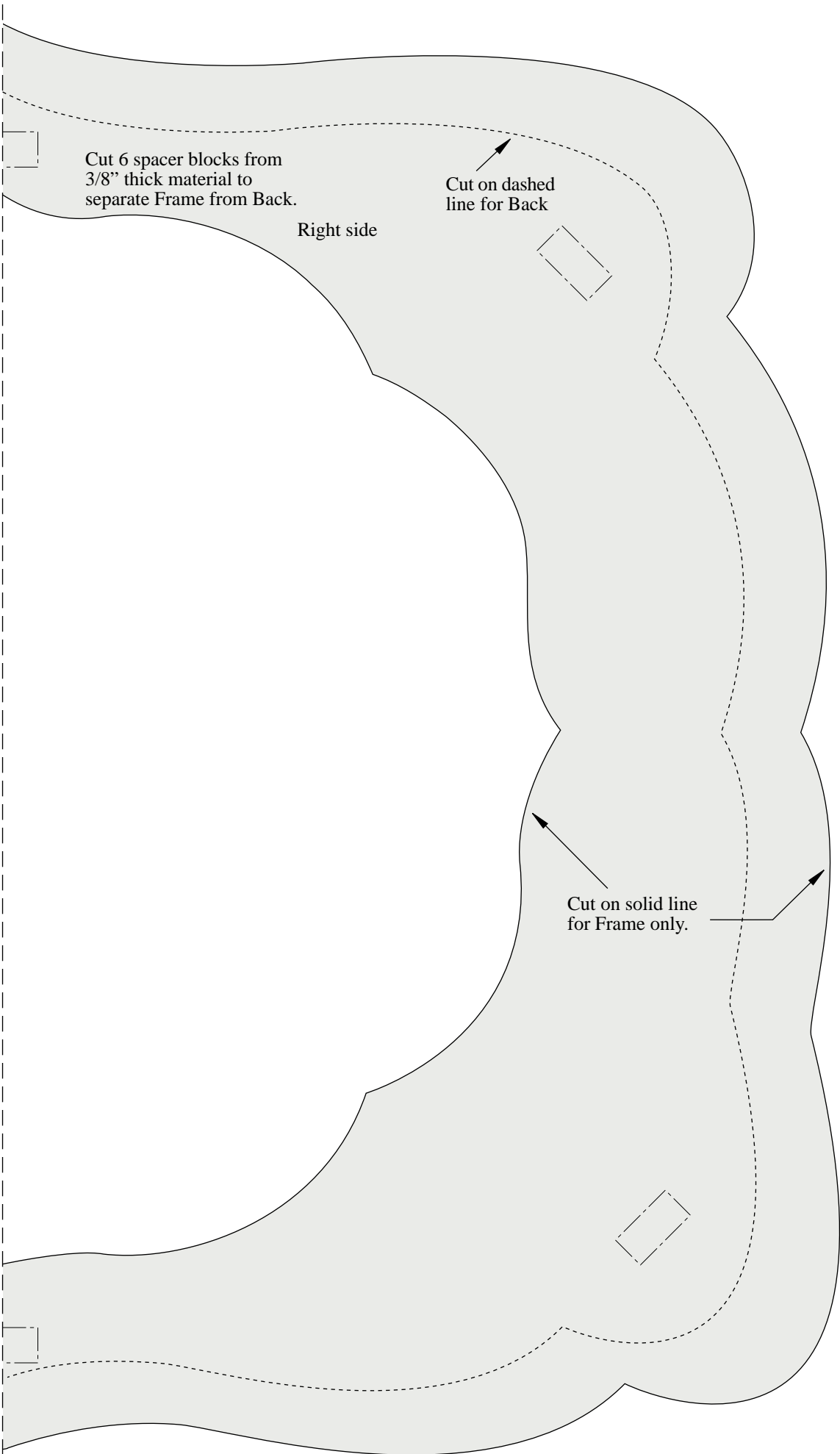



**Left Bird**  
Stock: 1/16" - 1/8"  
Spacers: 1/8", cut 3

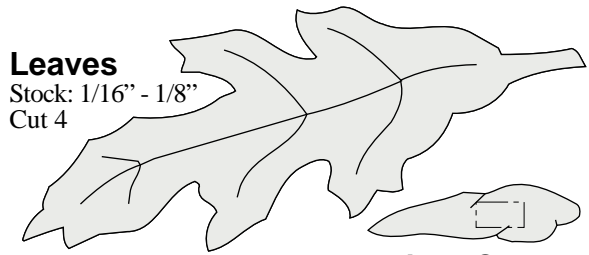

**Leaves**  
Stock: 1/16" - 1/8"  
Cut 4

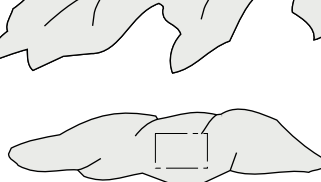

**Right Cloud**  
Stock: 1/16" - 1/8"  
Spacer: 1/8"

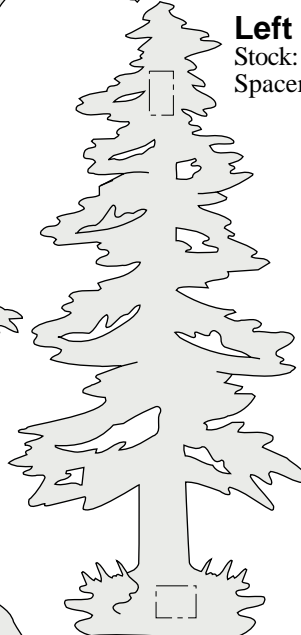

**Left Tree**  
Stock: 1/16" - 1/8"  
Spacer: 1/8"

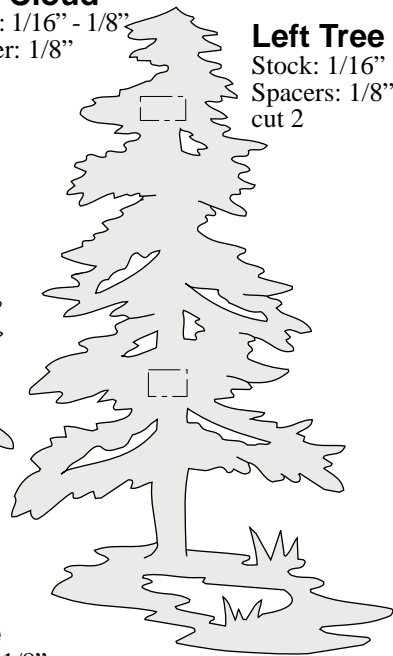

**Right Tree**  
Stock: 1/16" - 1/8"  
Spacers: 1/8", cut 2

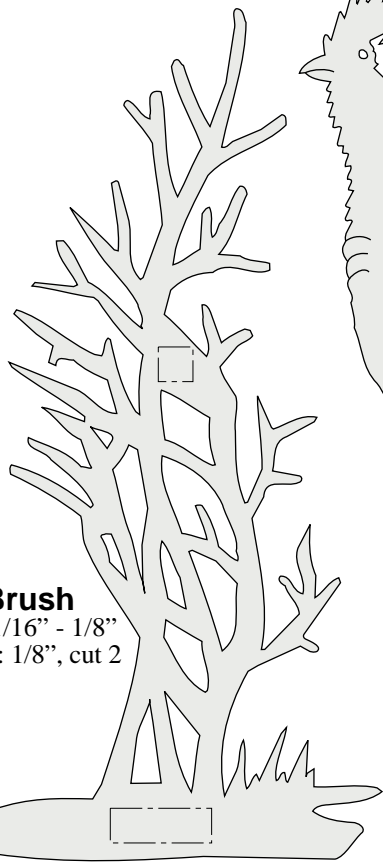

**Left Brush**  
Stock: 1/16" - 1/8"  
Spacers: 1/8", cut 2

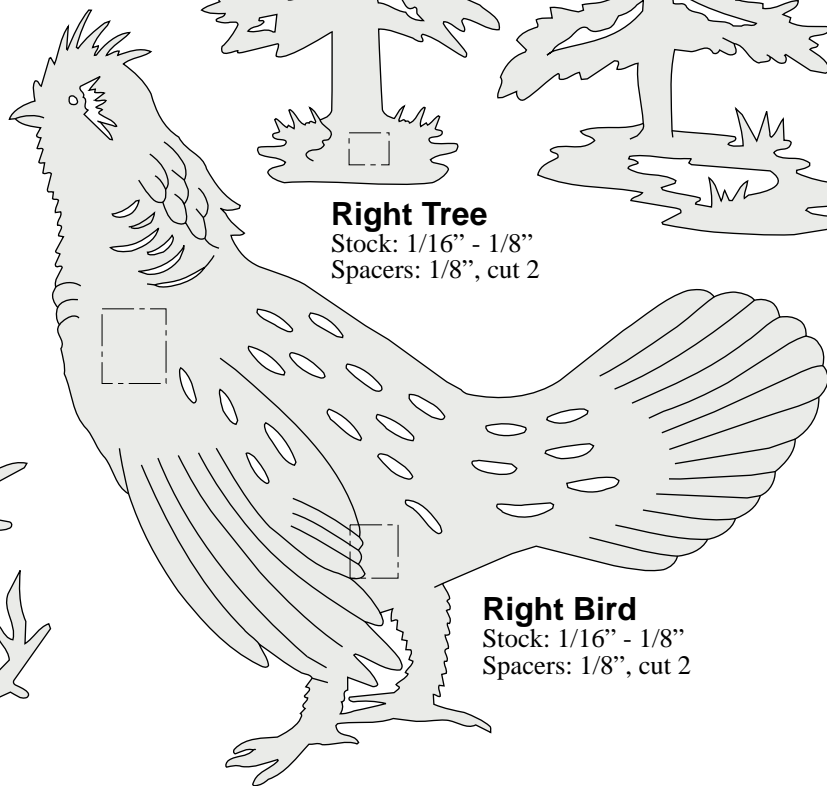

**Right Bird**  
Stock: 1/16" - 1/8"  
Spacers: 1/8", cut 2

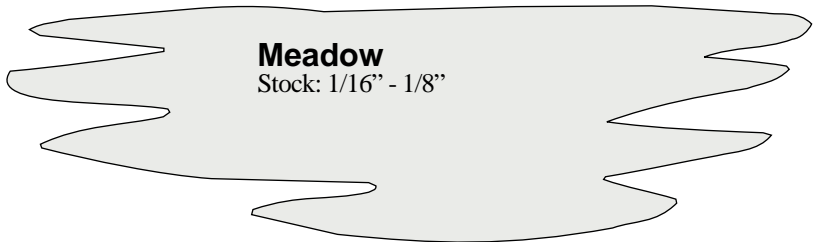

**Meadow**  
Stock: 1/16" - 1/8"

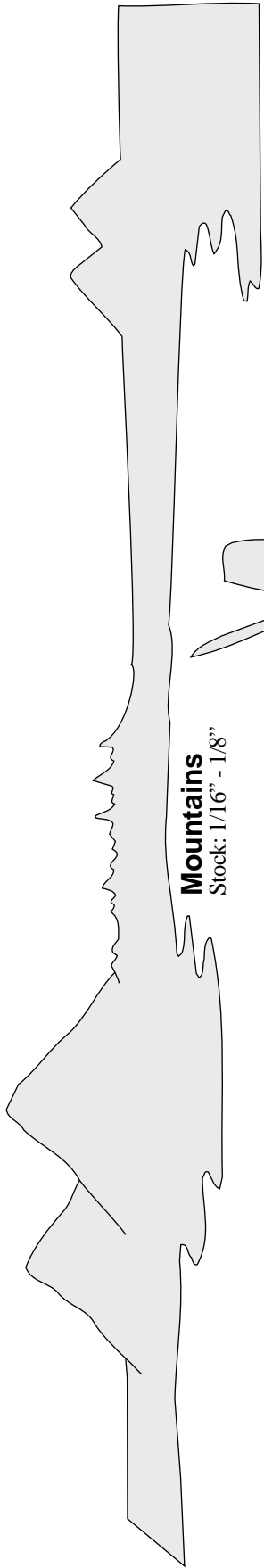

**Mountains**

Stock: 1/16" - 1/8"

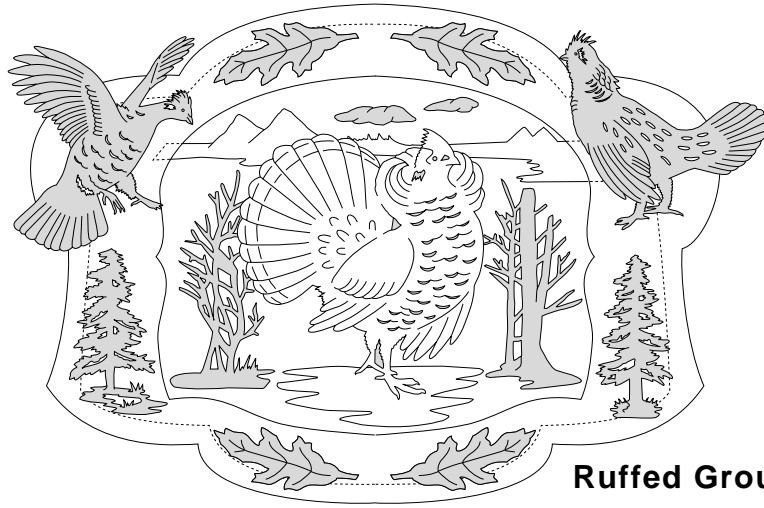

**Ruffed Grouse**

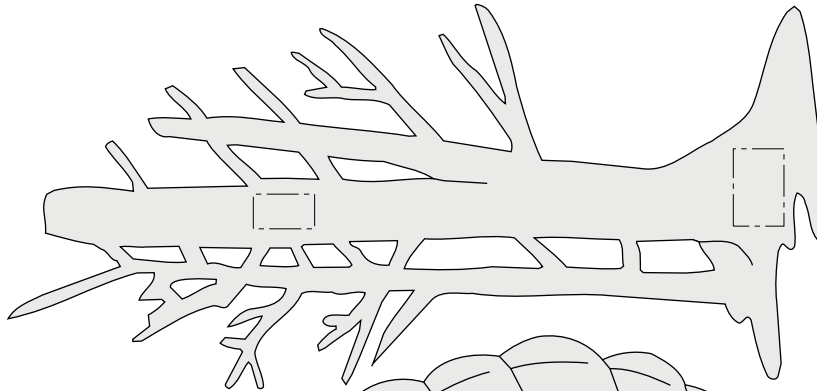

**Right Brush**

Stock: 1/16" - 1/8"  
Spacers: 1/8", cut 2

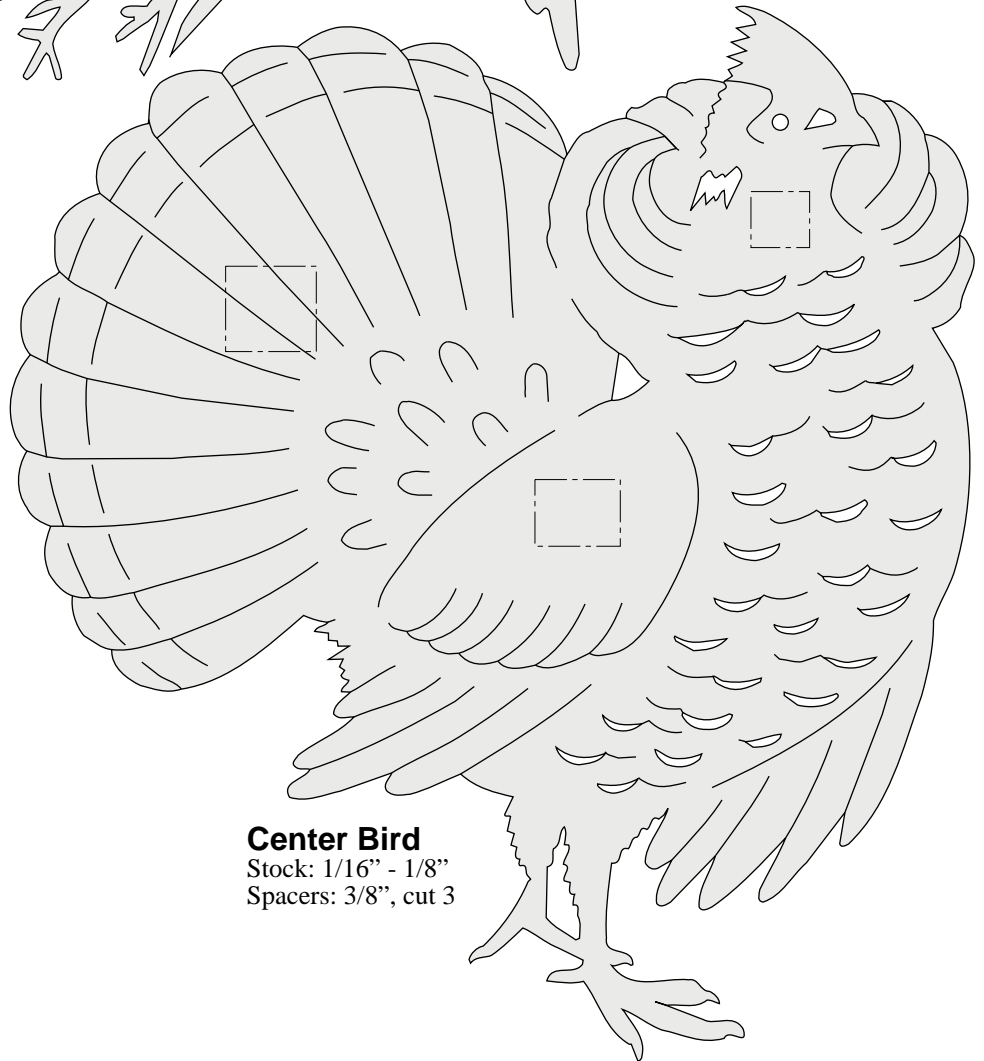

**Center Bird**

Stock: 1/16" - 1/8"  
Spacers: 3/8", cut 3

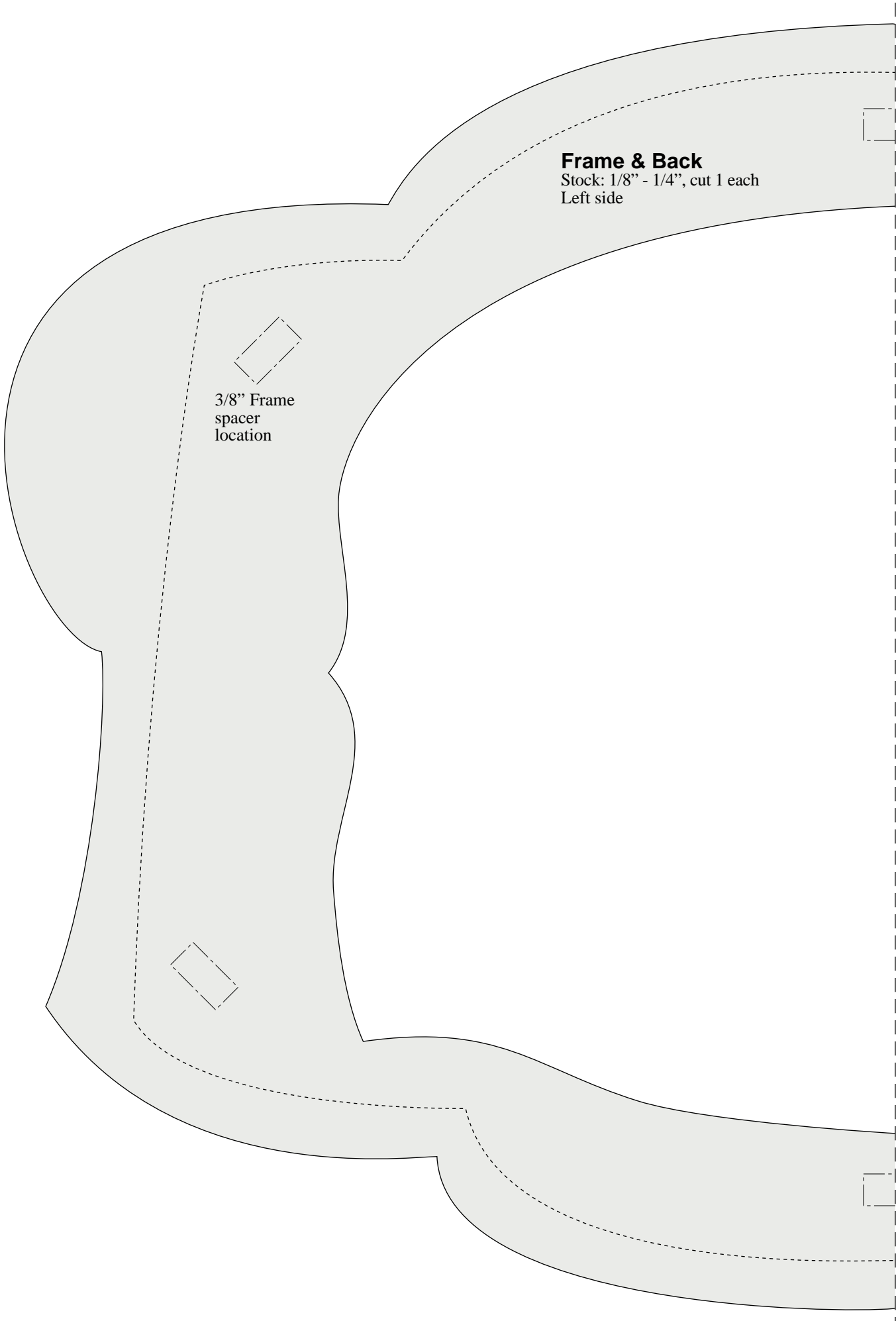

**Frame & Back**

Stock: 1/8" - 1/4", cut 1 each  
Left side

3/8" Frame  
spacer  
location

Pattern overlap line

Pattern overlap line



Cut 6 spacer blocks from  
3/8" thick material to  
separate Frame from Back.

Right side

Cut on dashed line  
for Back

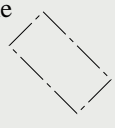

Cut on solid line  
for Frame only.

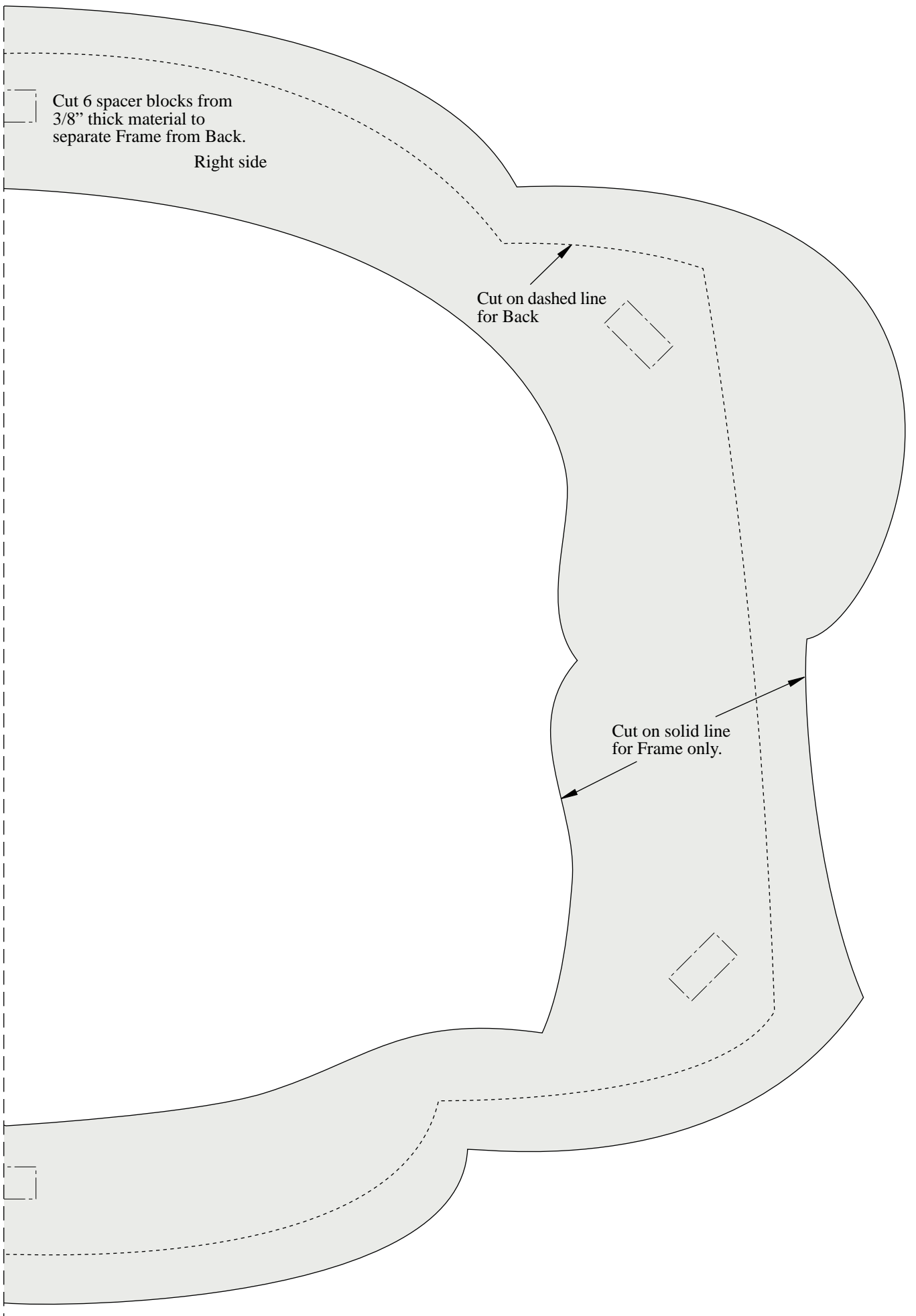
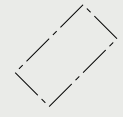

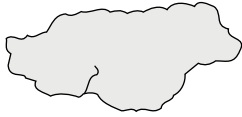

**Clouds**  
Stock: 1/16" - 1/8"

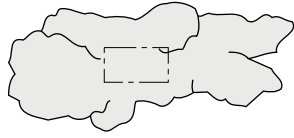

**Top Cloud**  
Stock: 1/16" - 1/8"  
Spacer: 1/8"

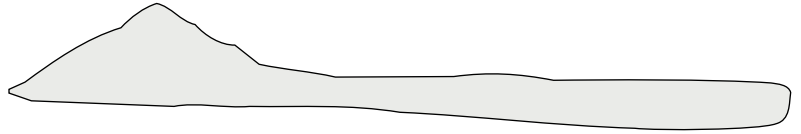

**Right Hills**  
Stock: 1/16" - 1/8"



**Left Hills**  
Stock: 1/16" - 1/8"

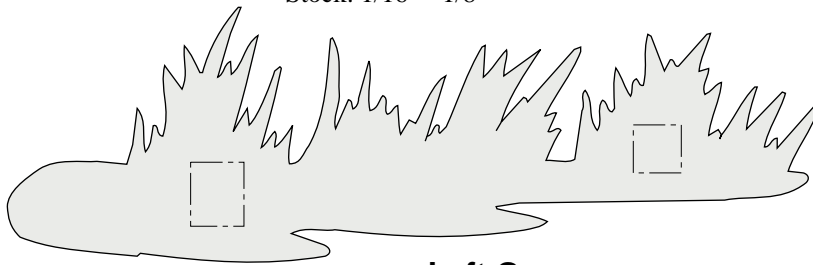

**Left Grass**  
Stock: 1/16" - 1/8"  
Spacers: 1/8", cut 2

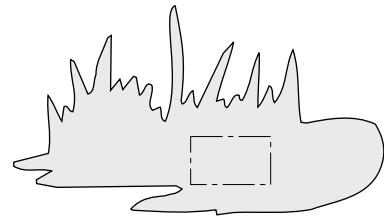

**Right Grass**  
Stock: 1/16" - 1/8"  
Spacer: 1/8"

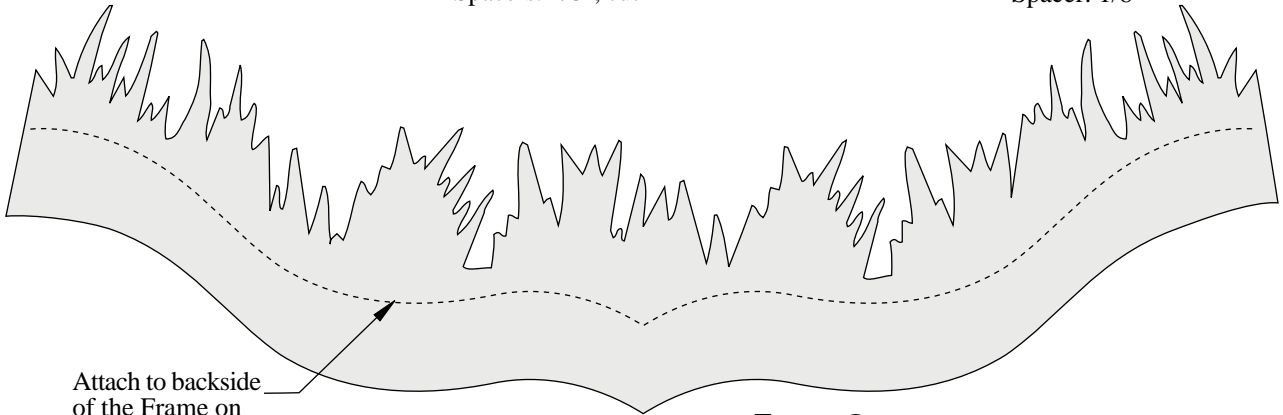

Attach to backside  
of the Frame on  
dashed line.

**Front Grass**  
Stock: 1/16" - 1/8"

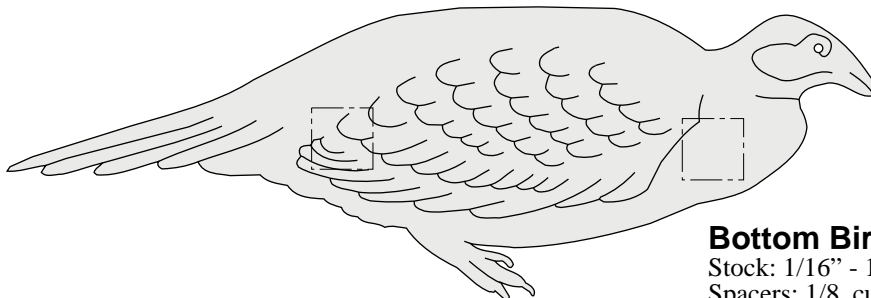

**Bottom Bird**  
Stock: 1/16" - 1/8"  
Spacers: 1/8, cut 2



**Sage Grouse**

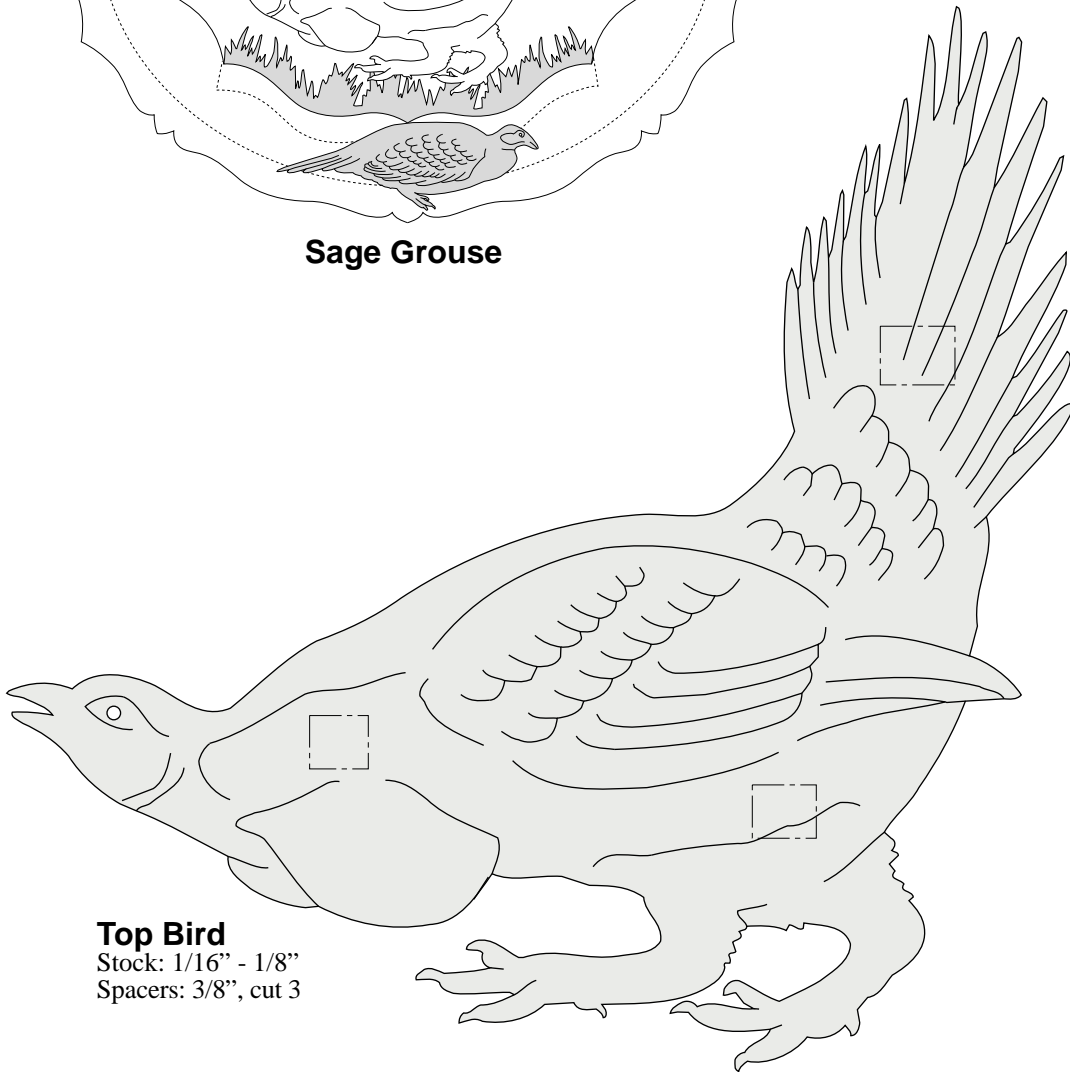

**Top Bird**  
Stock: 1/16" - 1/8"  
Spacers: 3/8", cut 3

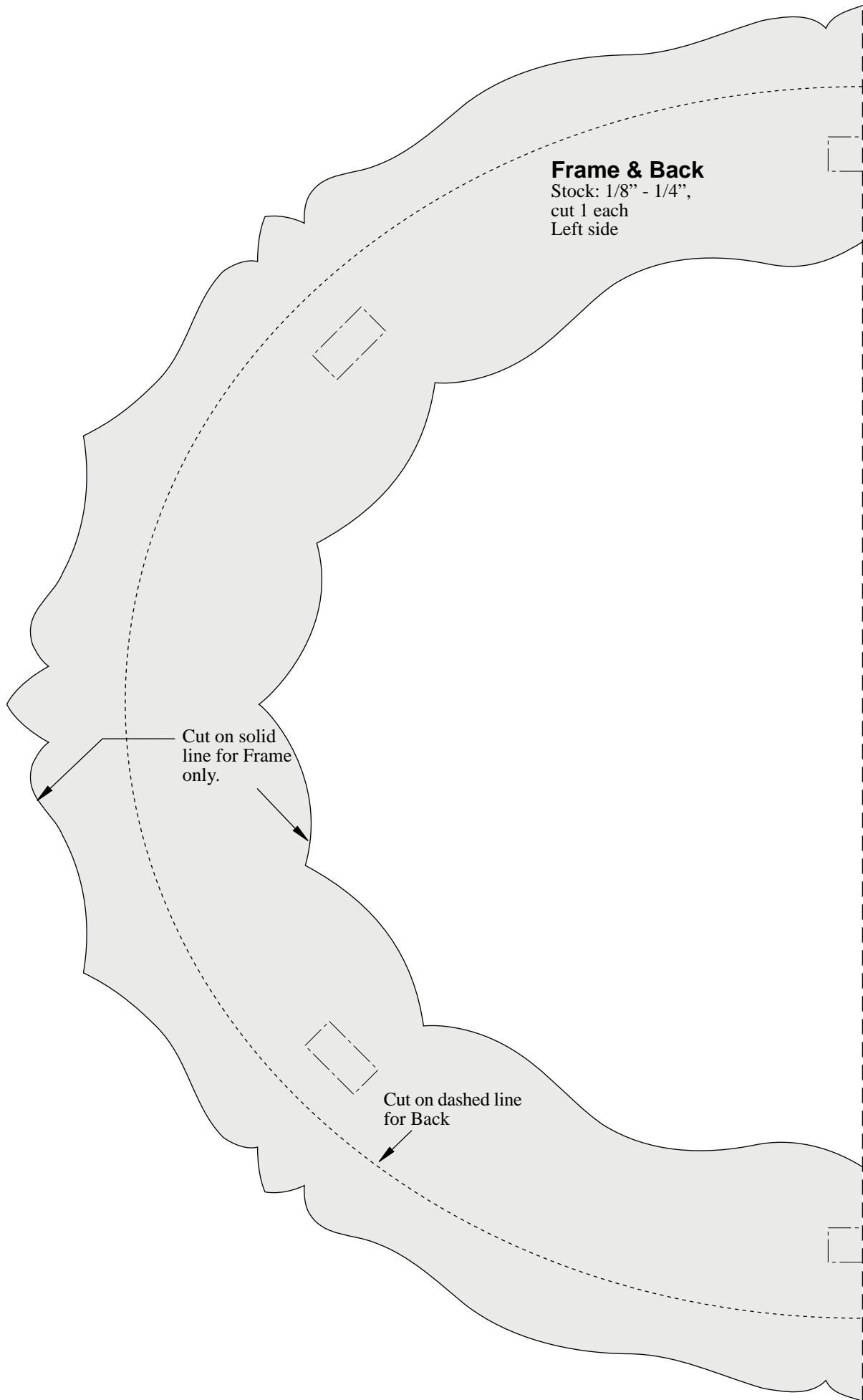

**Frame & Back**  
Stock: 1/8" - 1/4",  
cut 1 each  
Left side

Cut on solid  
line for Frame  
only.

Cut on dashed line  
for Back

Pattern overlap line



Pattern overlap line

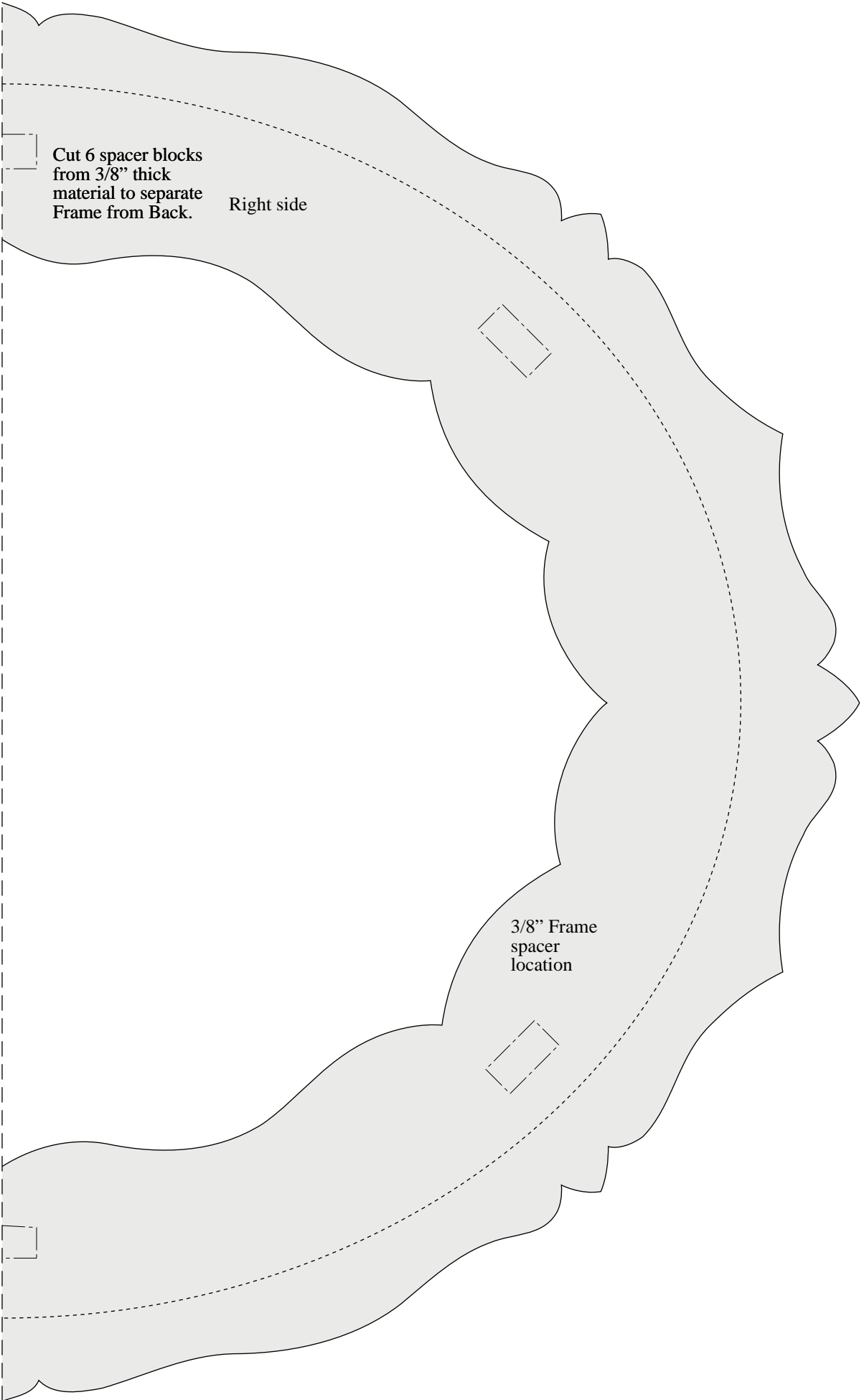

Cut 6 spacer blocks  
from 3/8" thick  
material to separate  
Frame from Back. Right side

3/8" Frame  
spacer  
location

3/8" Frame  
spacer  
location

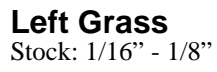
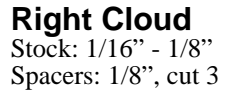
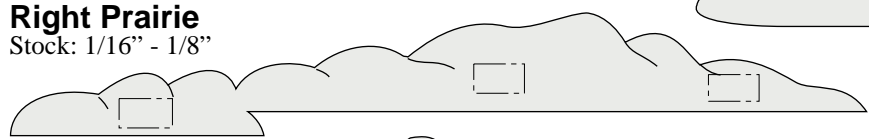
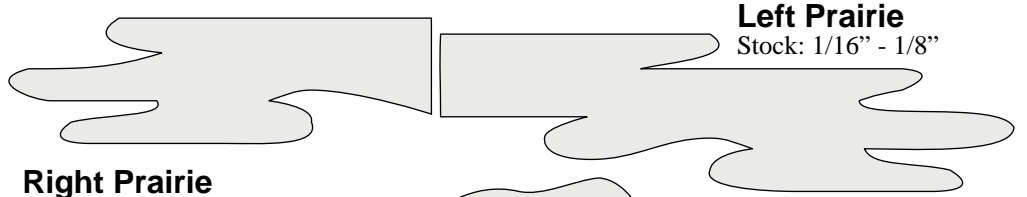
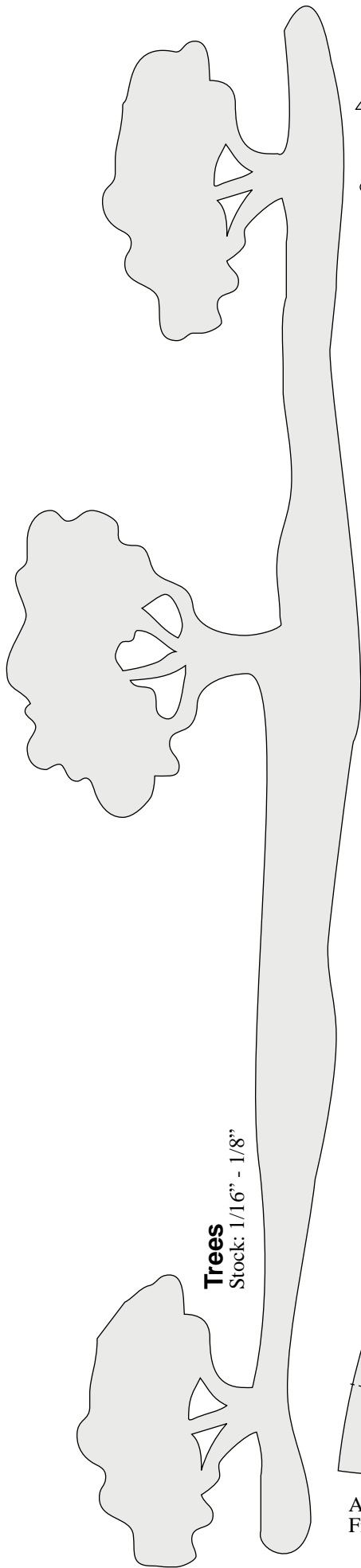

Attach to  
backside of the  
Frame on  
dashed line.

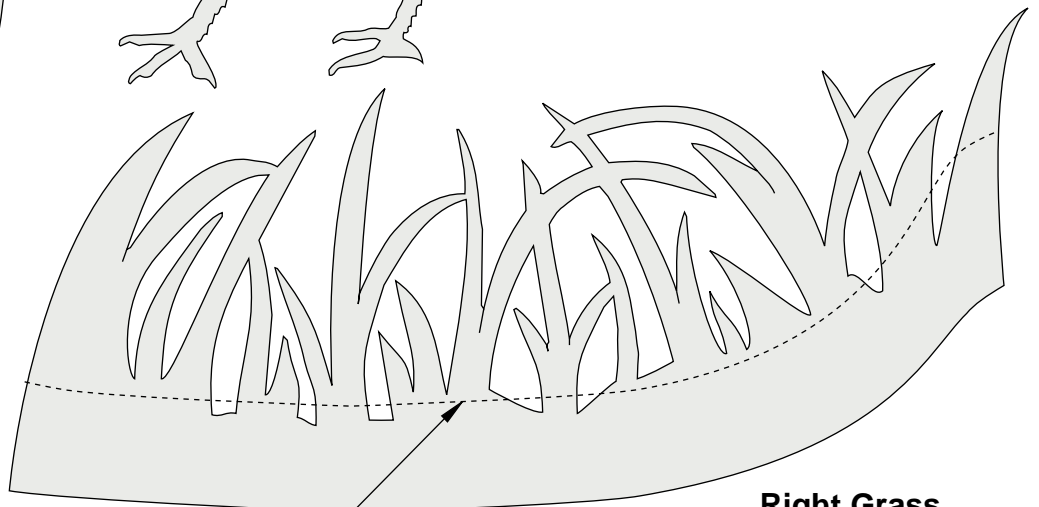
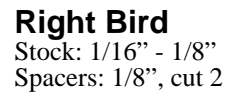
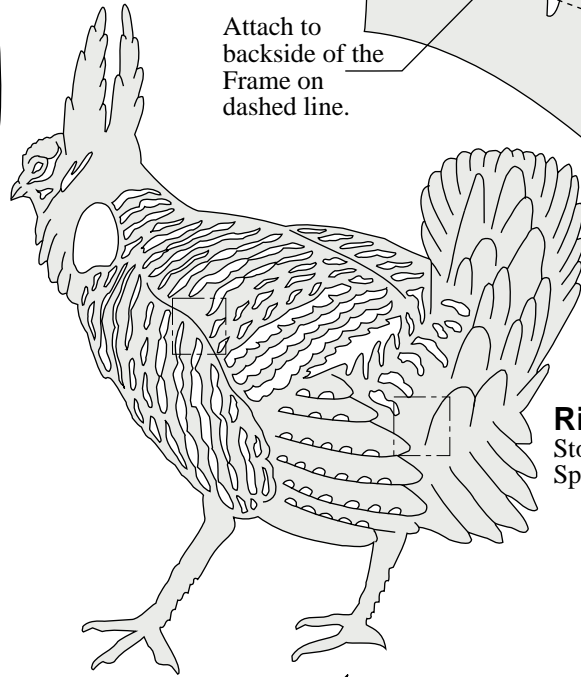

Attach to backside of the  
Frame on dashed line.

**Left Bird**

Stock: 1/16" - 1/8"  
Spacers: 1/8", cut 2

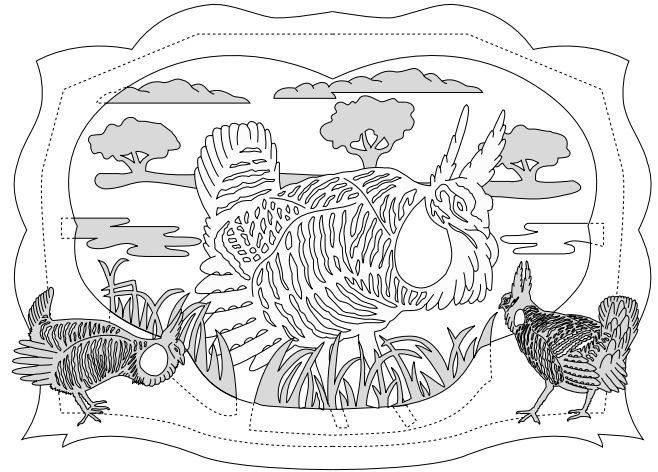
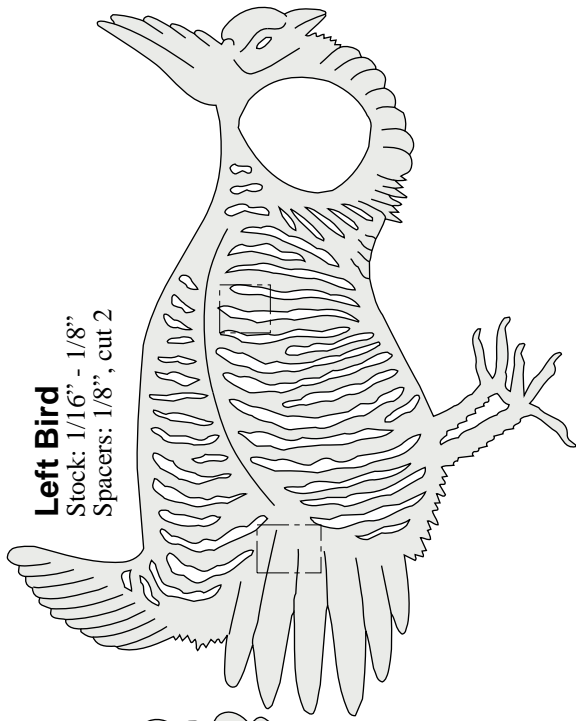

**Prairie Chicken**

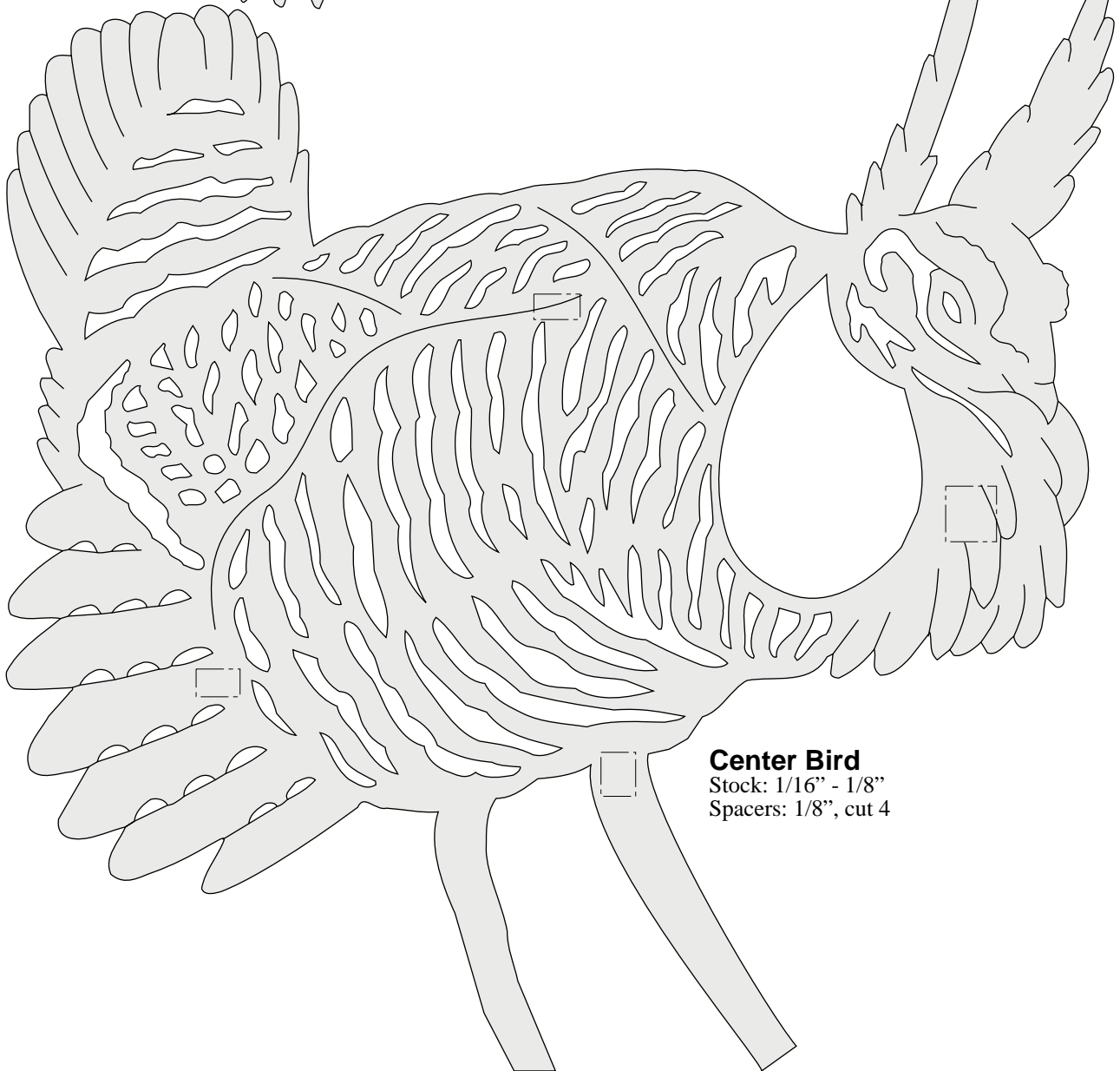

**Center Bird**

Stock: 1/16" - 1/8"  
Spacers: 1/8", cut 4

**Frame & Back**

Stock: 1/8" - 1/4", cut 1 each

Left side

3/8" Frame  
spacer  
location

Pattern overlap line

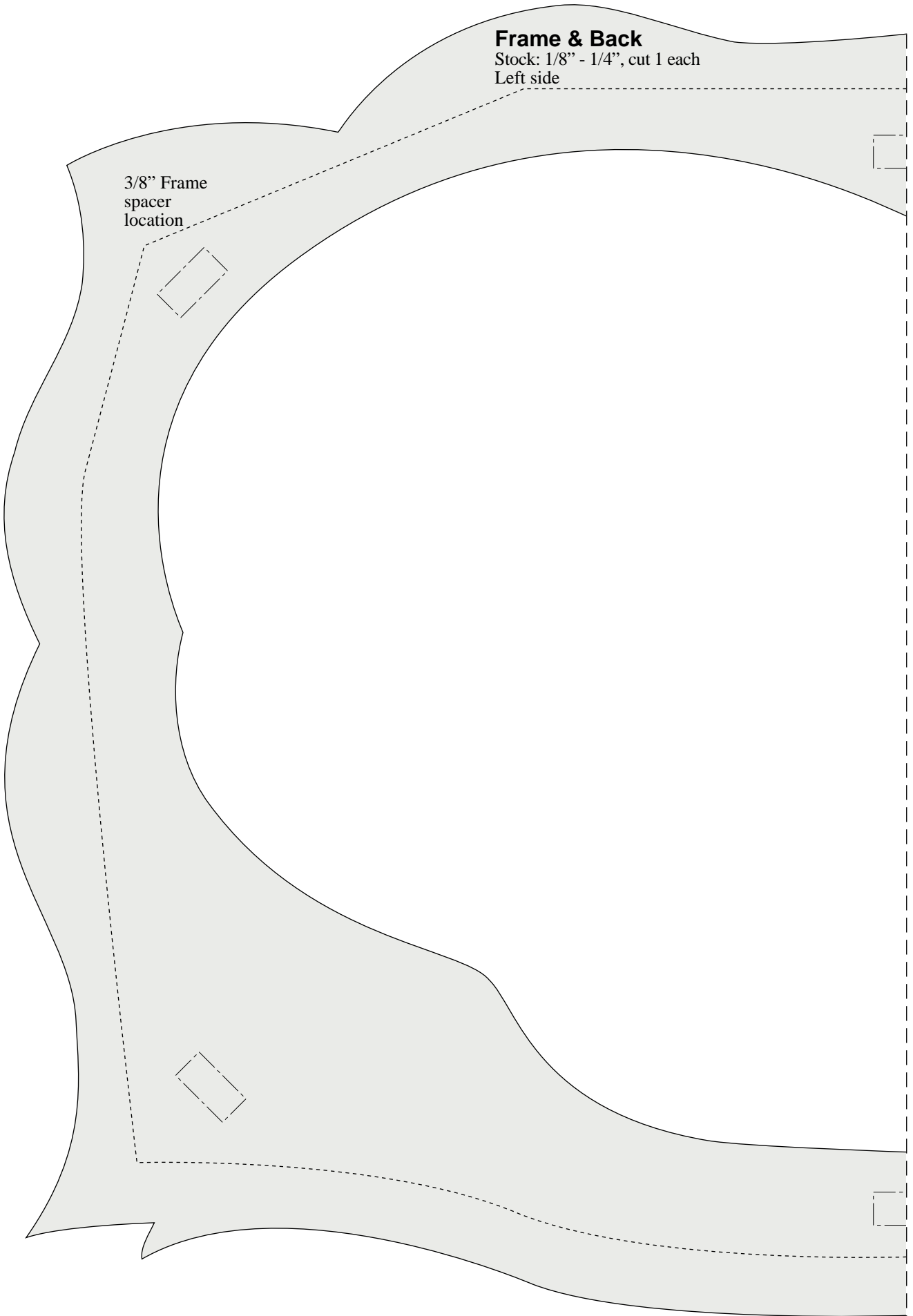

Pattern overlap line

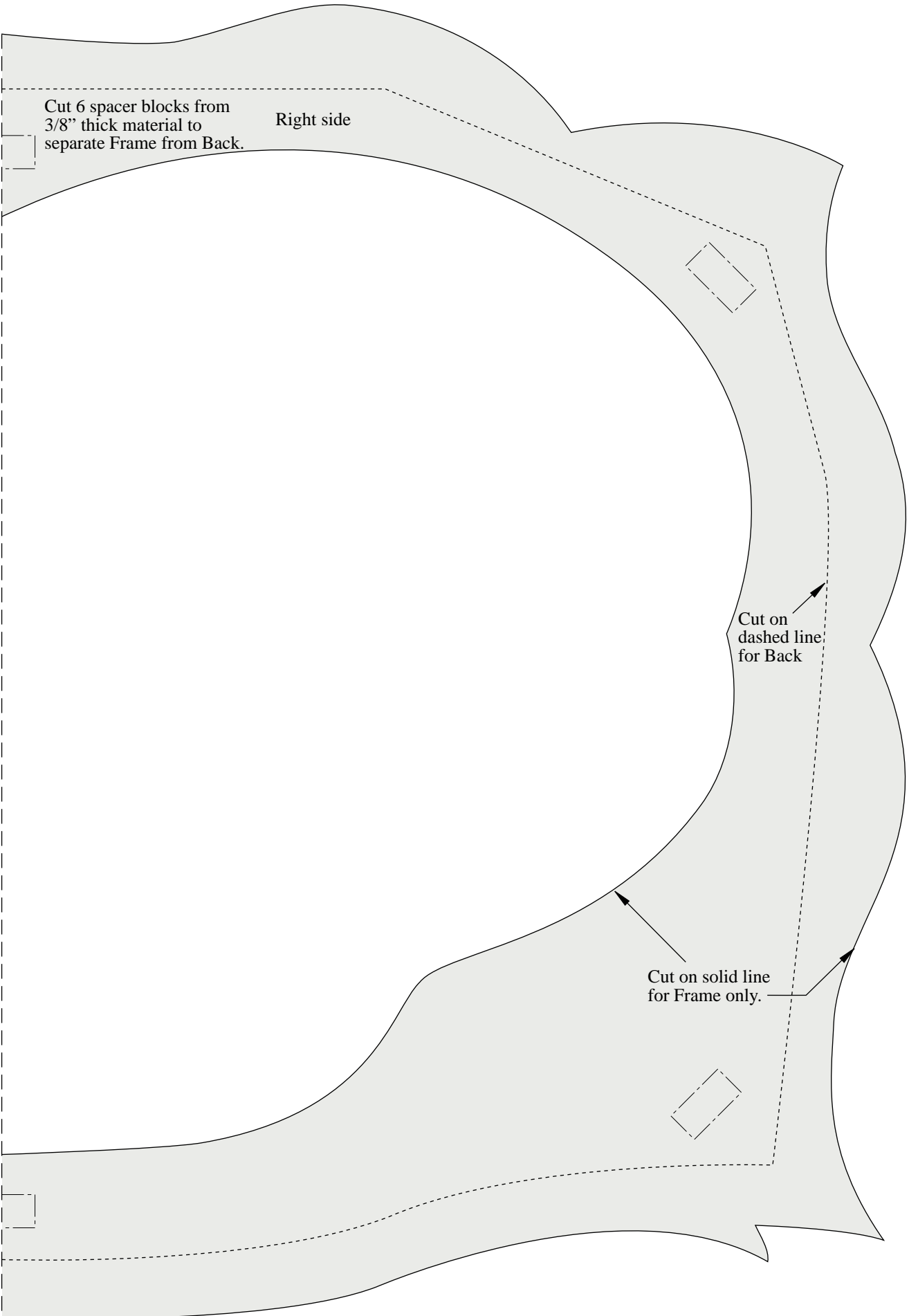

Cut 6 spacer blocks from  
3/8" thick material to  
separate Frame from Back.

Right side

Cut on dashed line  
for Back

Cut on solid line  
for Frame only.

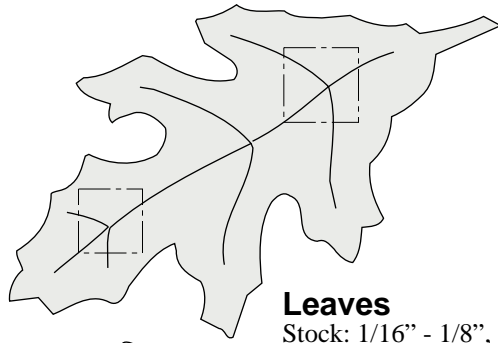

**Leaves**

Stock: 1/16" - 1/8", cut 2  
Stock: 1/8", cut 4

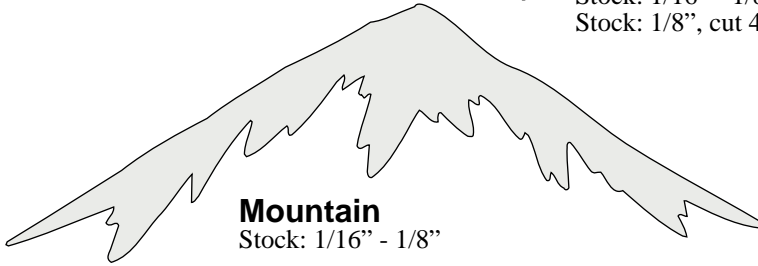

**Mountain**

Stock: 1/16" - 1/8"

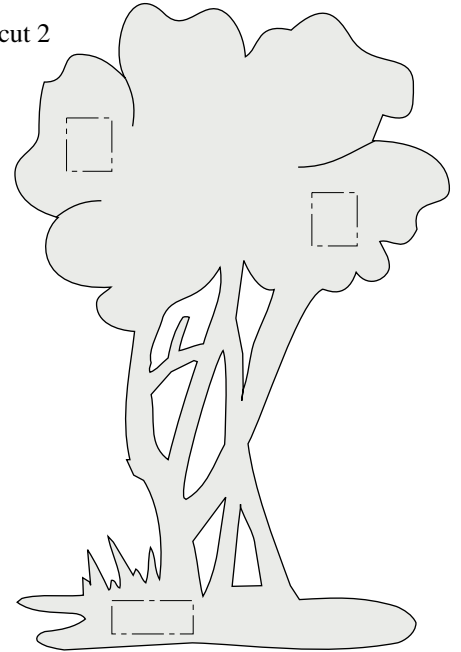

**Trees**

Stock: 1/16" - 1/8"  
Spacers: 1/8", cut 3

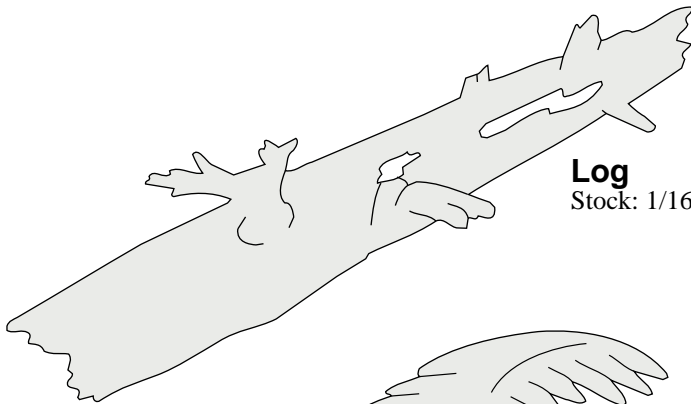

**Log**

Stock: 1/16" - 1/8"

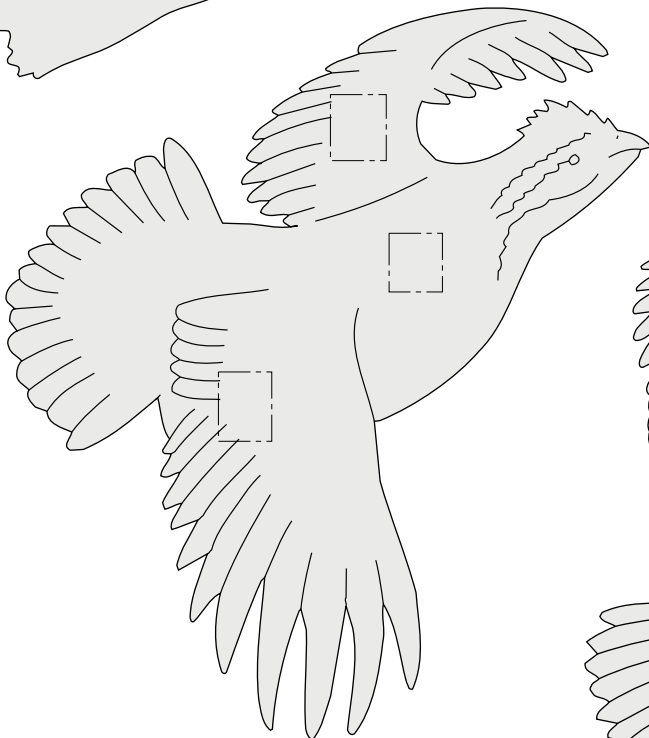

**Right Bird**

Stock: 1/16" - 1/8"  
Spacers: 1/8", cut 3

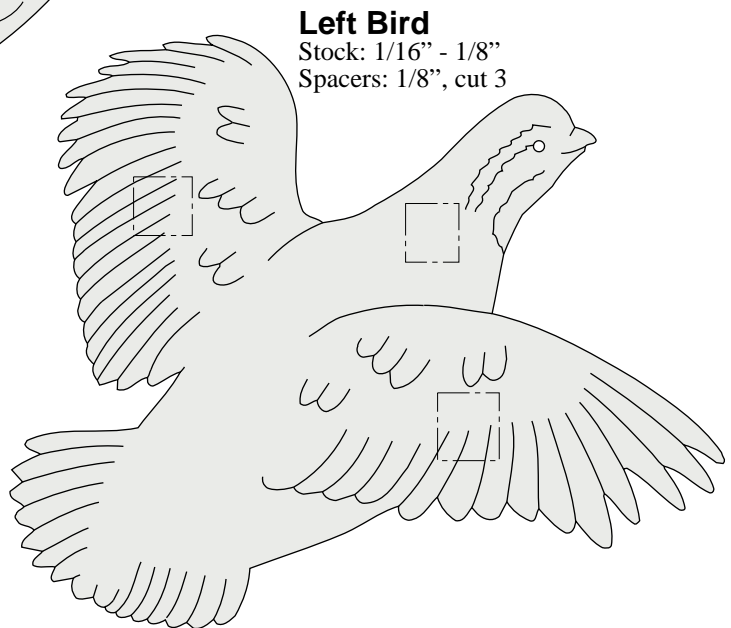

**Left Bird**

Stock: 1/16" - 1/8"  
Spacers: 1/8", cut 3

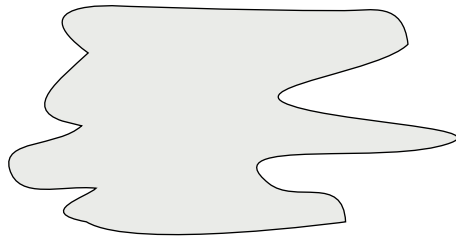

**Ground**  
Stock: 1/16" - 1/8"

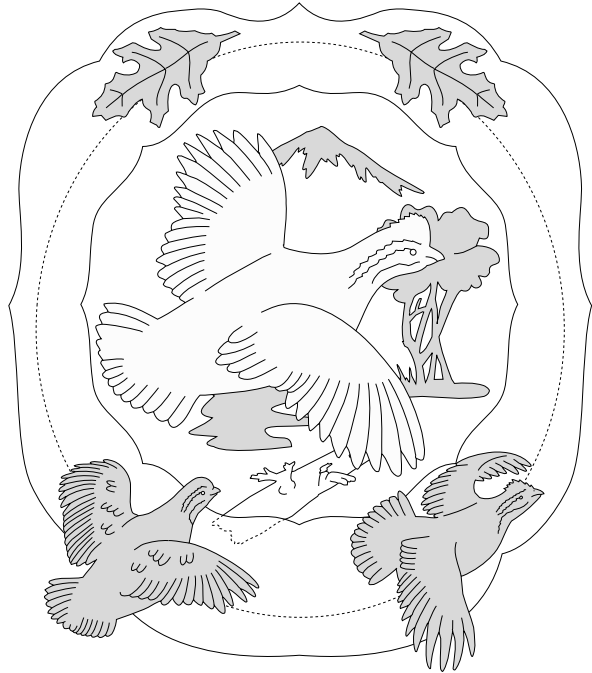

**Bobwhite**

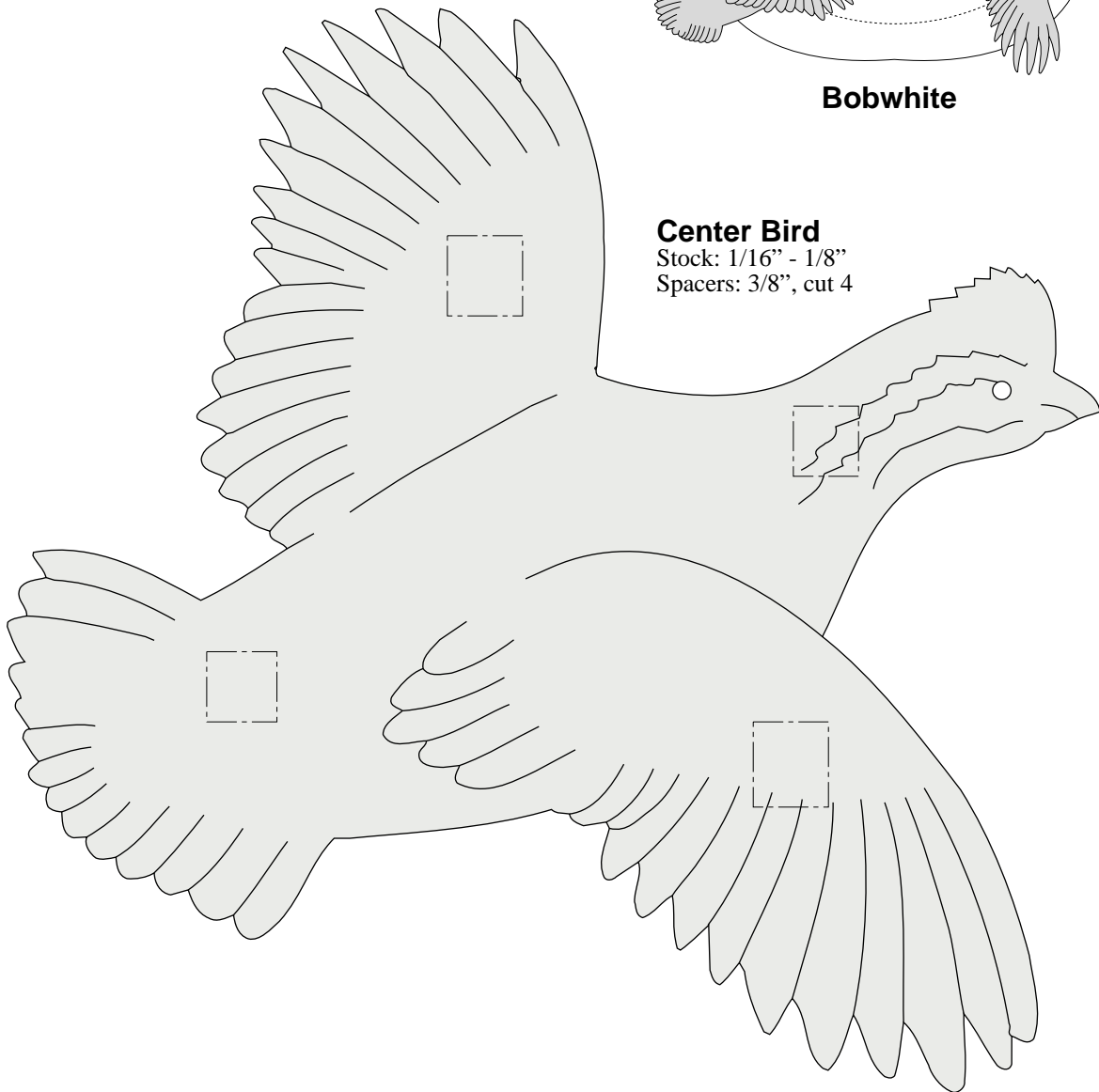

**Center Bird**  
Stock: 1/16" - 1/8"  
Spacers: 3/8", cut 4

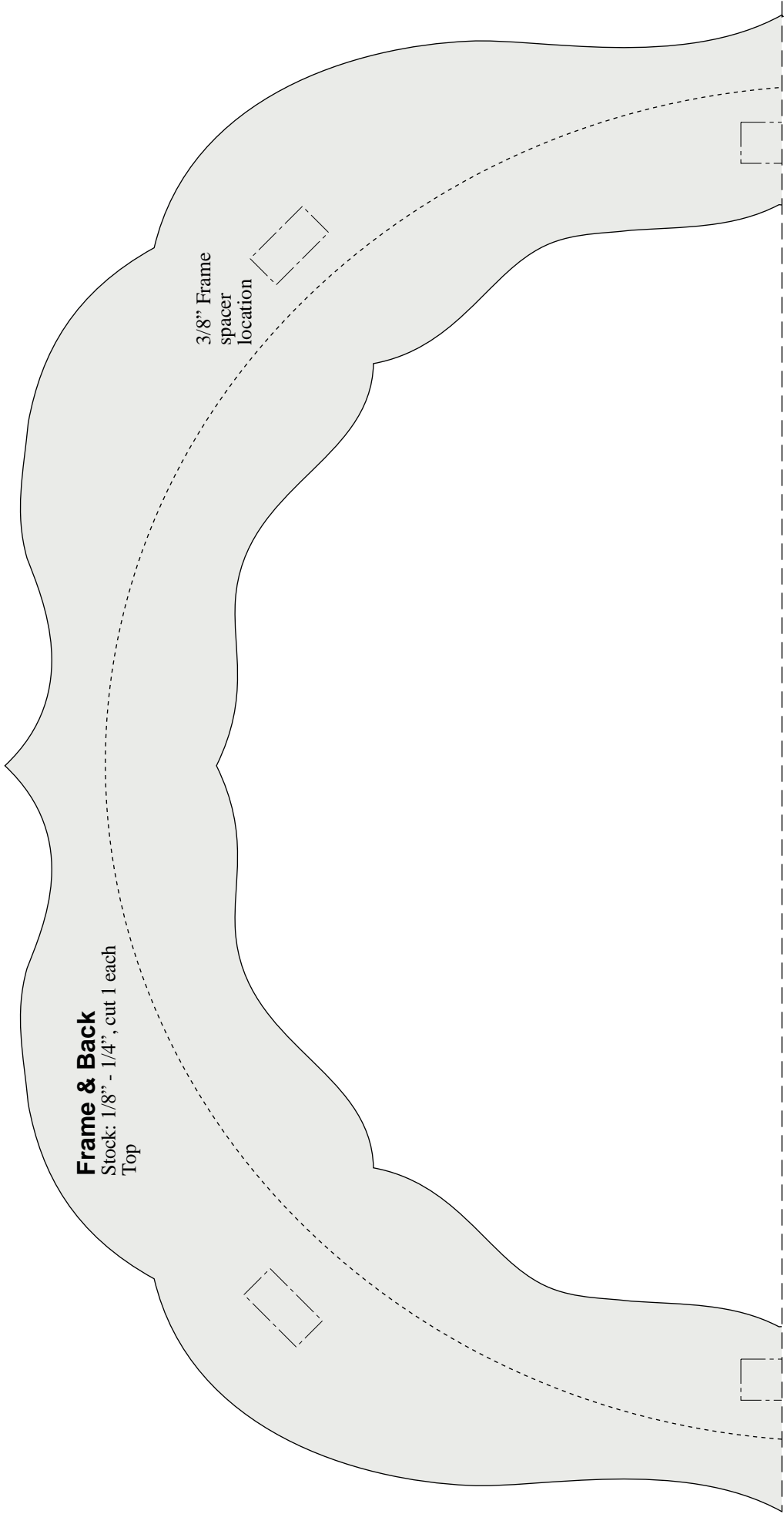

**Frame & Back**

Stock: 1/8" - 1/4", cut 1 each

Top

3/8" Frame  
spacer  
location

Pattern overlap line



Pattern overlap line

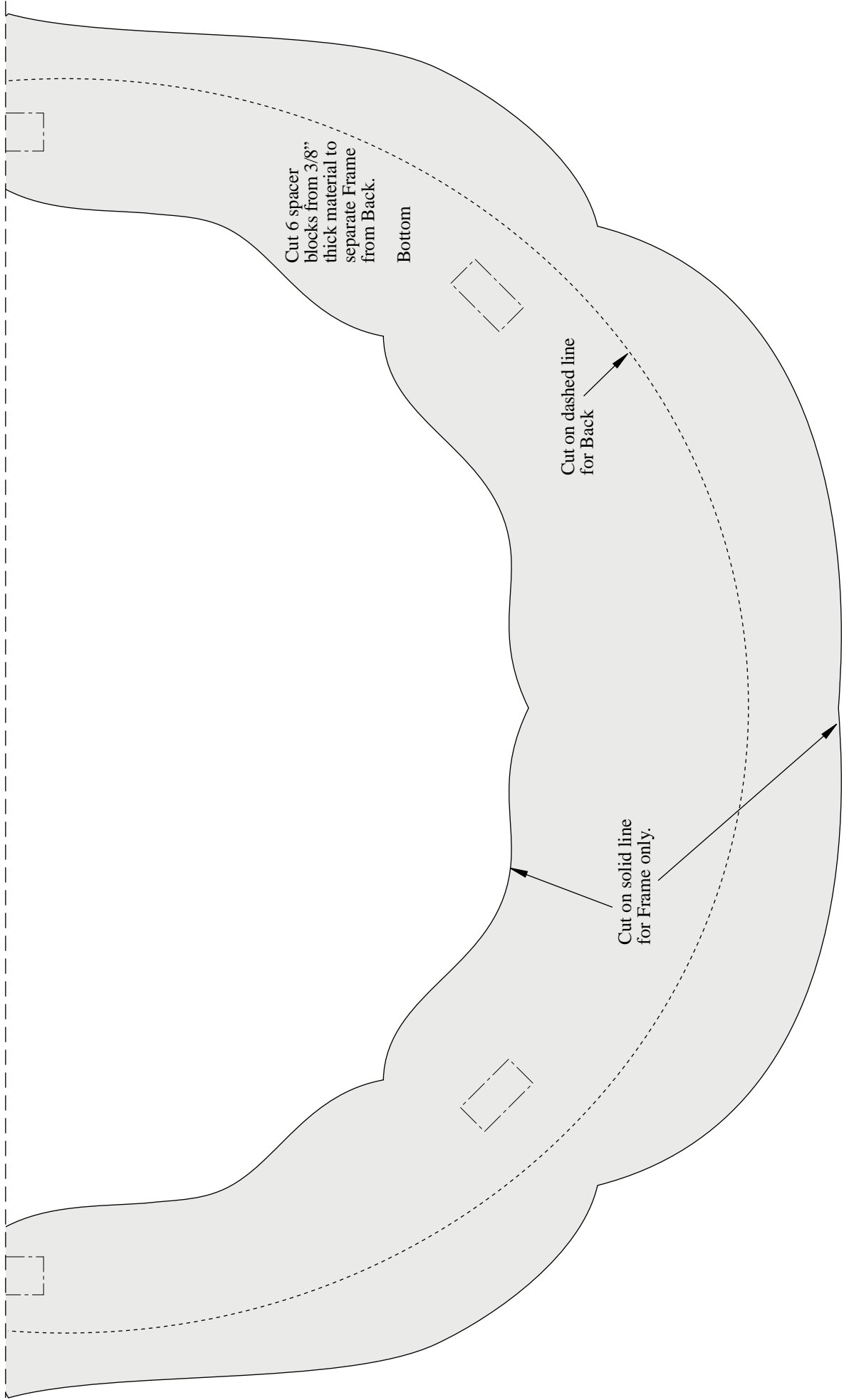

Cut 6 spacer blocks from 3/8" thick material to separate Frame from Back.

Bottom

Cut on dashed line for Back

Cut on solid line for Frame only.

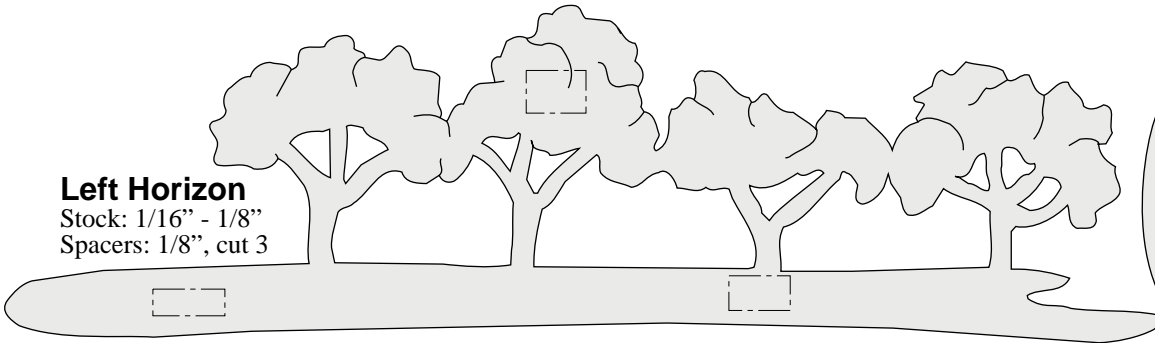

**Left Horizon**  
Stock: 1/16" - 1/8"  
Spacers: 1/8", cut 3

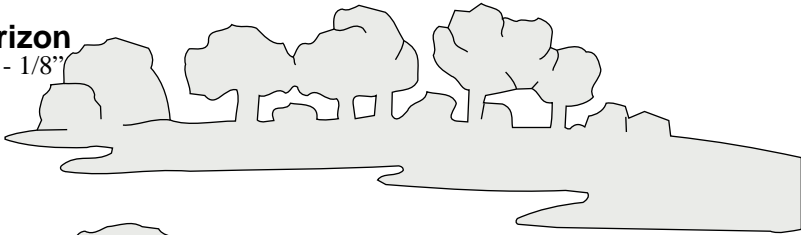

**Right Horizon**  
Stock: 1/16" - 1/8"

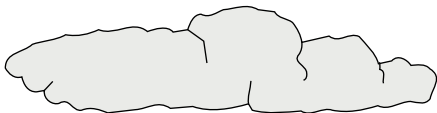

**Right Cloud**  
Stock: 1/16" - 1/8"



**Left Cloud**  
Stock: 1/16" - 1/8"  
Spacer: 1/8"

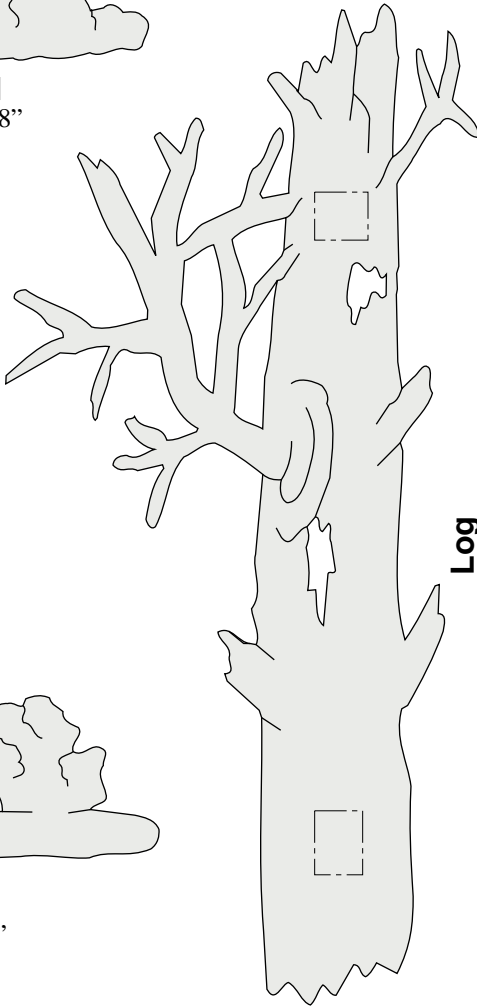

**Log**  
Stock: 1/16" - 1/8"  
Spacer: 1/8", cut 2

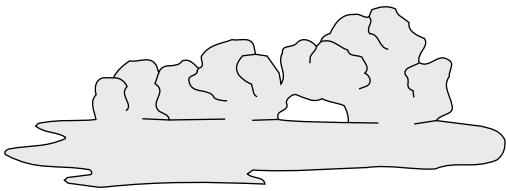

**Bushes**  
Stock: 1/16" - 1/8"

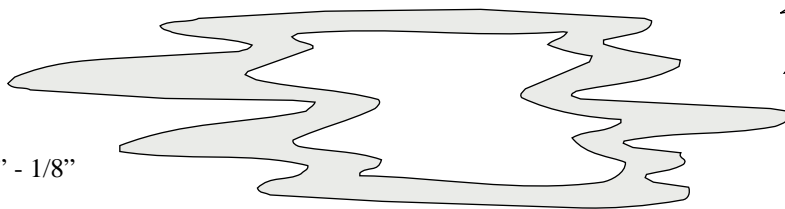

**Water**  
Stock: 1/16" - 1/8"

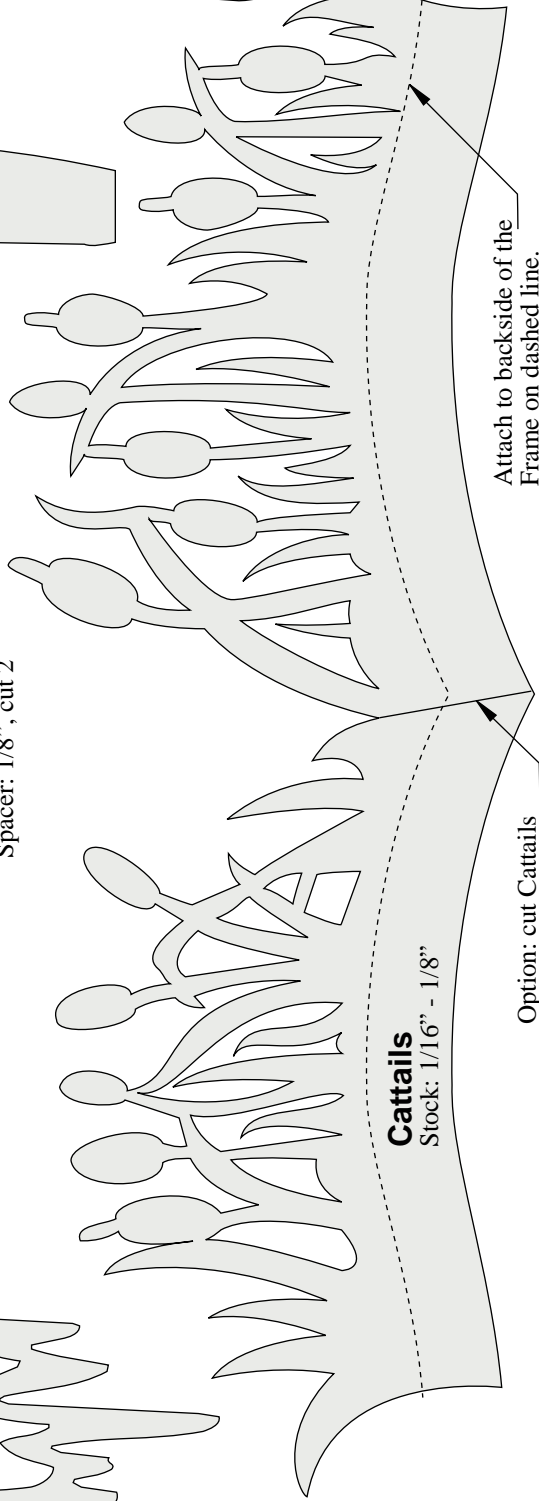

**Cattails**  
Stock: 1/16" - 1/8"

Attach to backside of the Frame on dashed line.

Option: cut Cattails in two pieces.

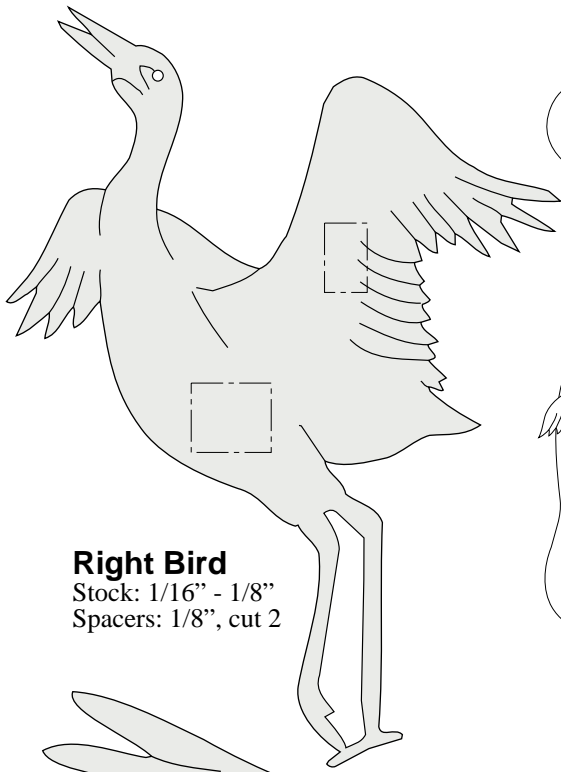

**Right Bird**  
Stock: 1/16" - 1/8"  
Spacers: 1/8", cut 2

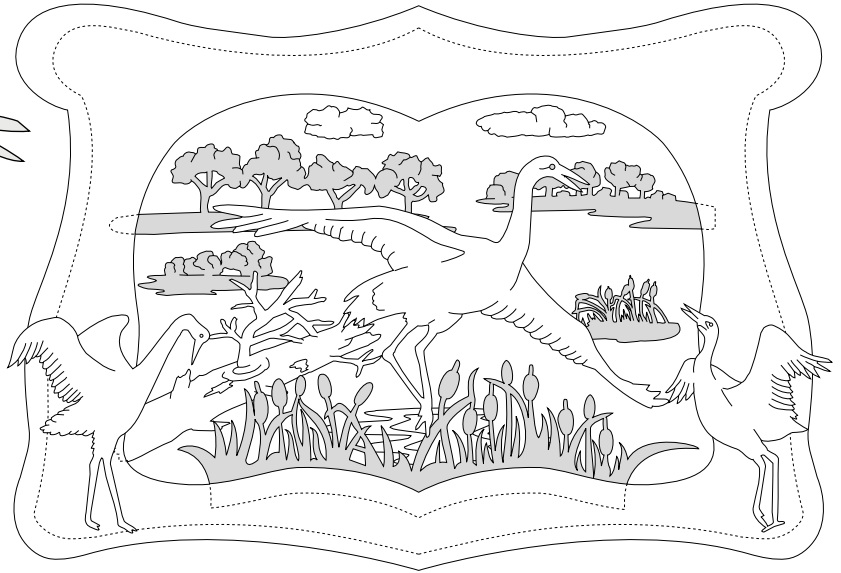

**Whooping Crane**

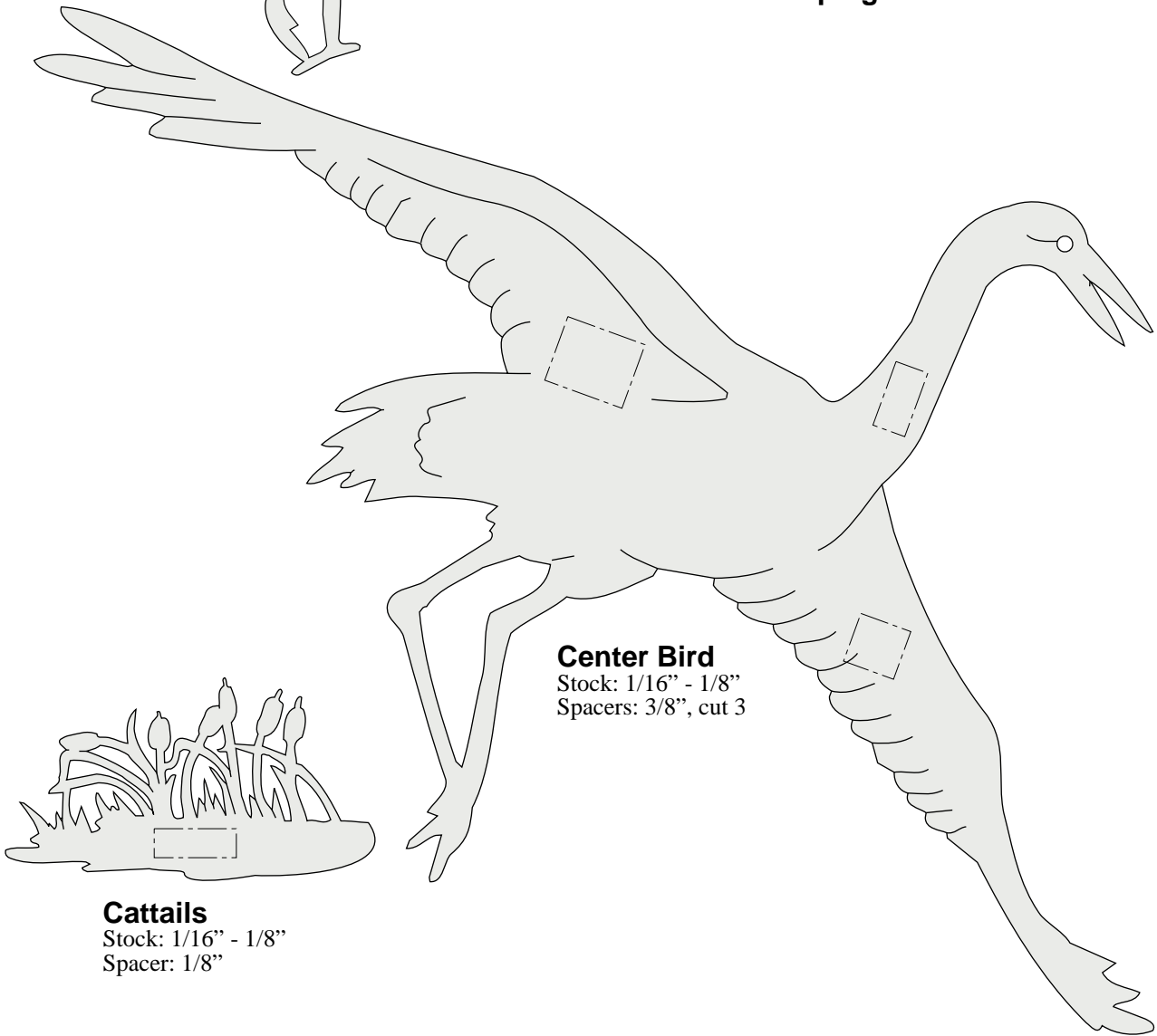

**Center Bird**  
Stock: 1/16" - 1/8"  
Spacers: 3/8", cut 3

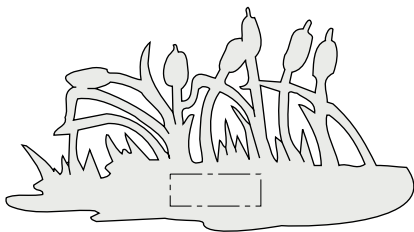

**Cattails**  
Stock: 1/16" - 1/8"  
Spacer: 1/8"

**Frame & Back**

Stock: 1/8" - 1/4", cut 1 each  
Left side

3/8" Frame  
spacer  
location

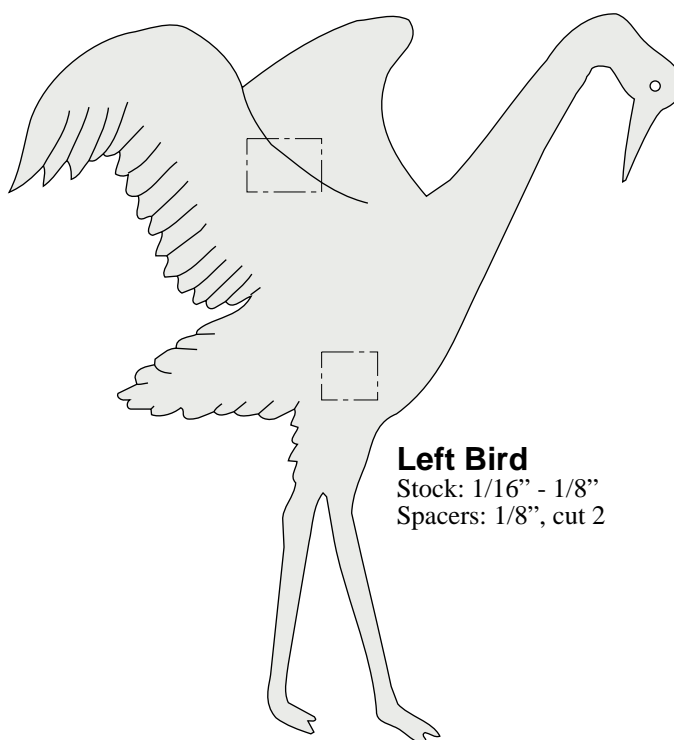

**Left Bird**

Stock: 1/16" - 1/8"  
Spacers: 1/8", cut 2

Pattern overlap line

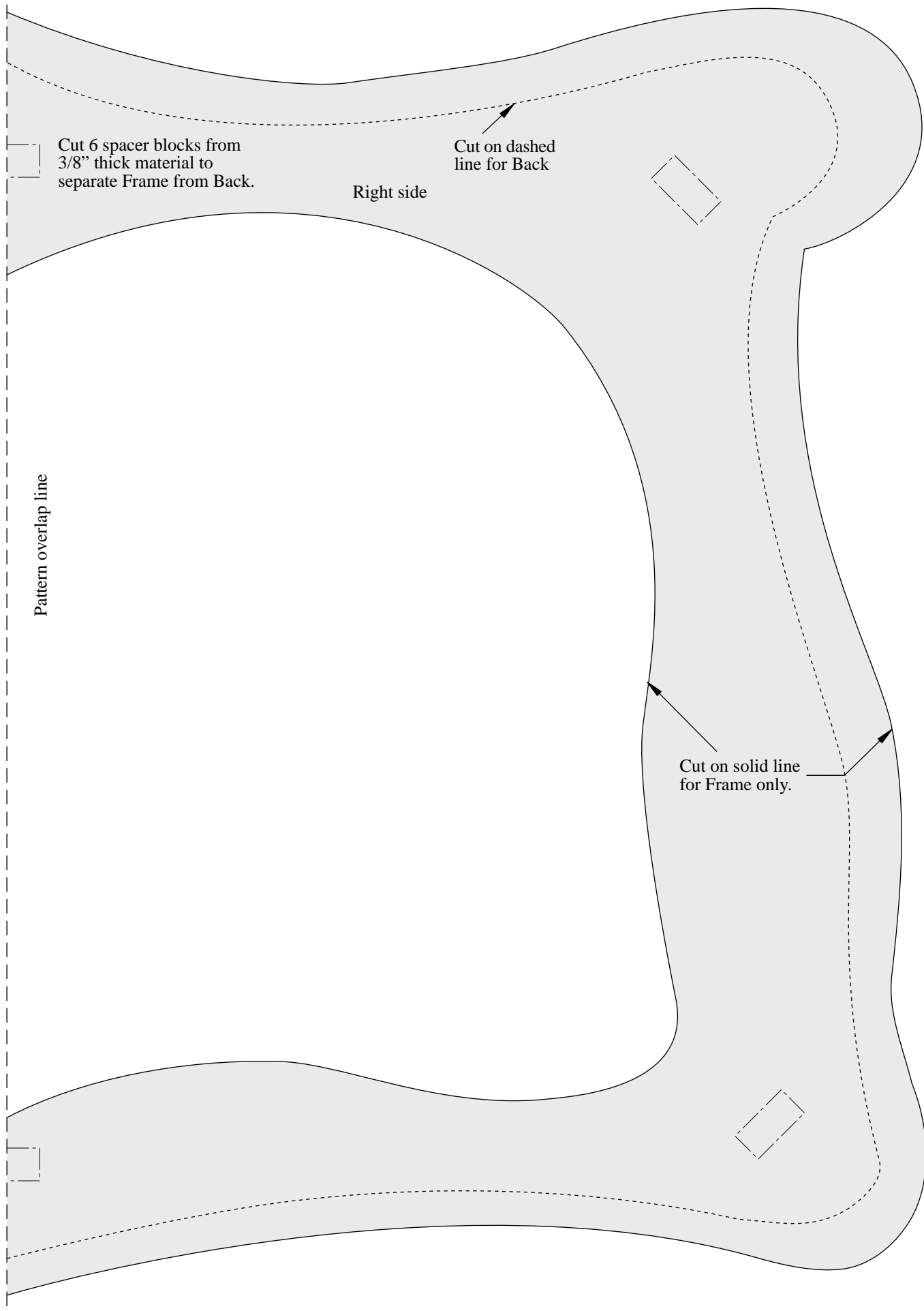

Cut 6 spacer blocks from  
3/8" thick material to  
separate Frame from Back.

Right side

Cut on dashed  
line for Back

Pattern overlap line

Cut on solid line  
for Frame only.

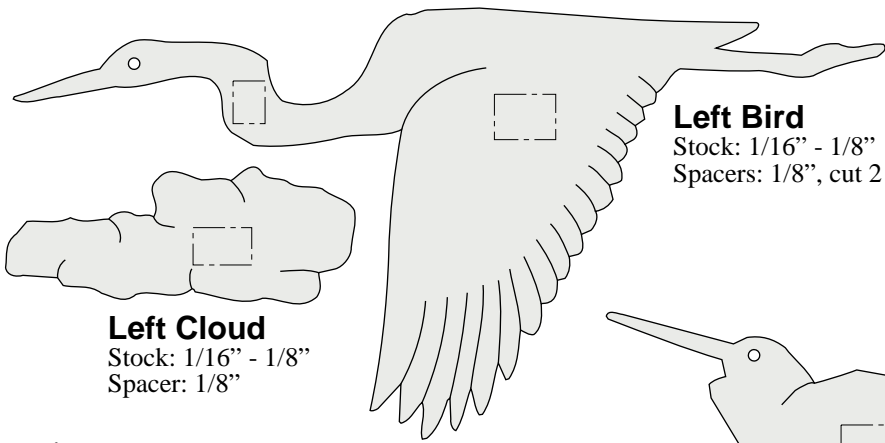

**Left Bird**  
Stock: 1/16" - 1/8"  
Spacers: 1/8", cut 2

**Left Cloud**  
Stock: 1/16" - 1/8"  
Spacer: 1/8"

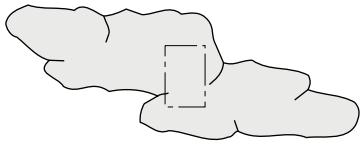

**Right Cloud**  
Stock: 1/16" - 1/8"  
Spacer: 1/8"

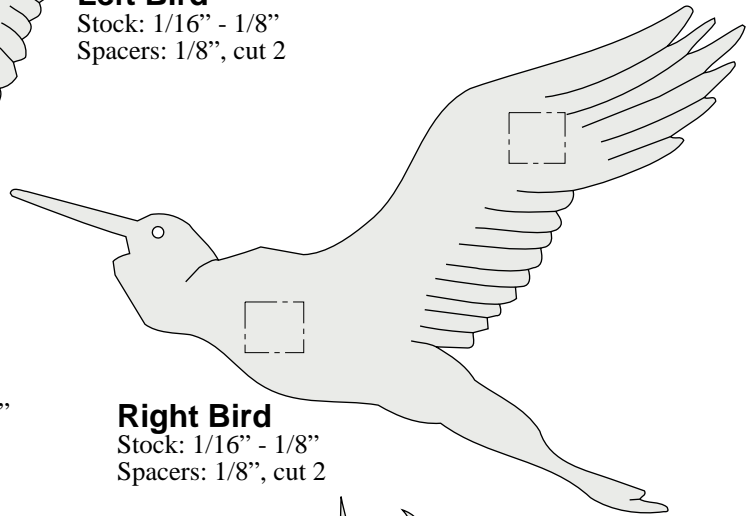

**Right Bird**  
Stock: 1/16" - 1/8"  
Spacers: 1/8", cut 2

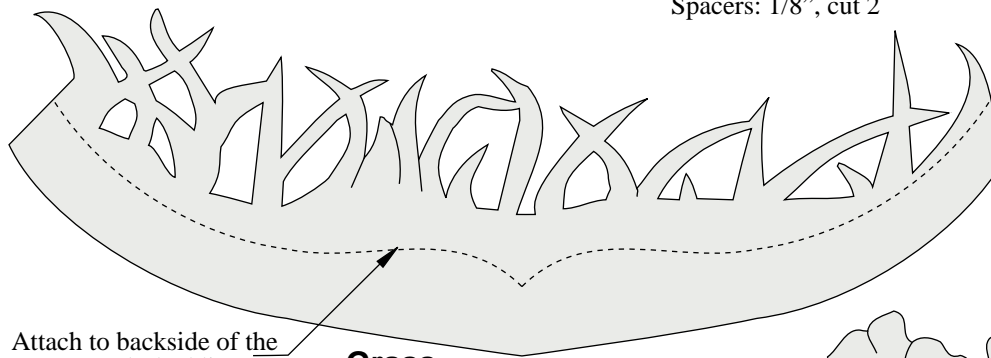

Attach to backside of the Frame on dashed line.

**Grass**  
Stock: 1/16" - 1/8"



**Right Horizon**  
Stock: 1/16" - 1/8"  
Spacers: 1/8", cut 2

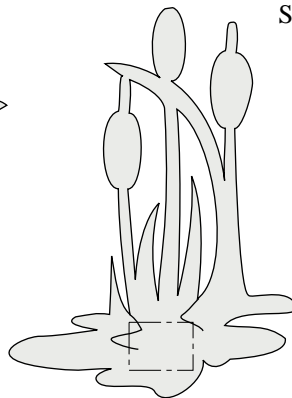
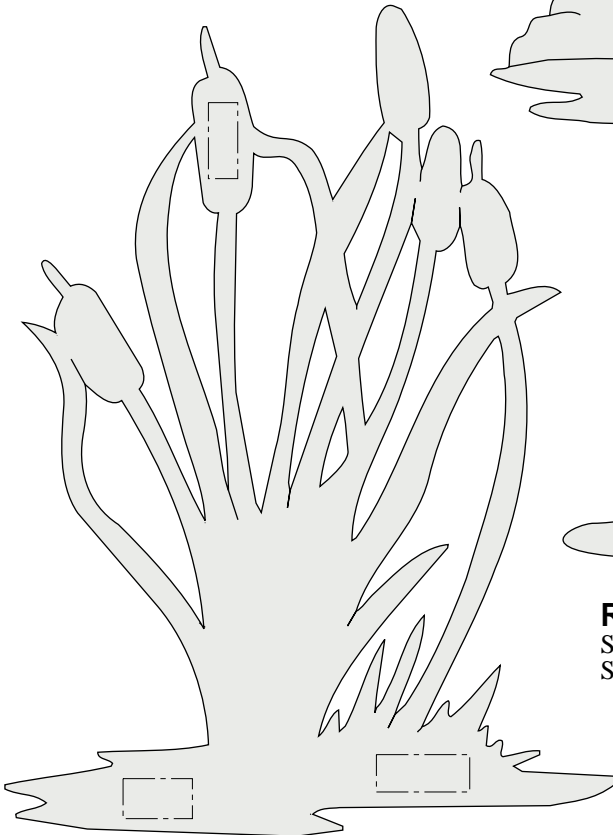

**Right Cattails**  
Stock: 1/16" - 1/8"  
Spacer: 1/4

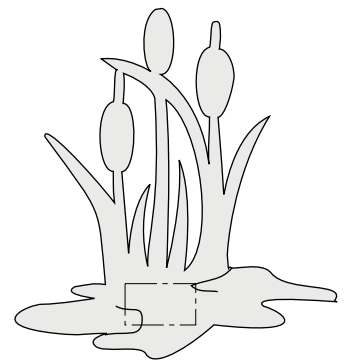

**Left Cattails**  
Stock: 1/16" - 1/8"  
Spacer: 1/8"

**Left Front Cattails**  
Stock: 1/16" - 1/8"  
Spacers: 1/8", cut 3

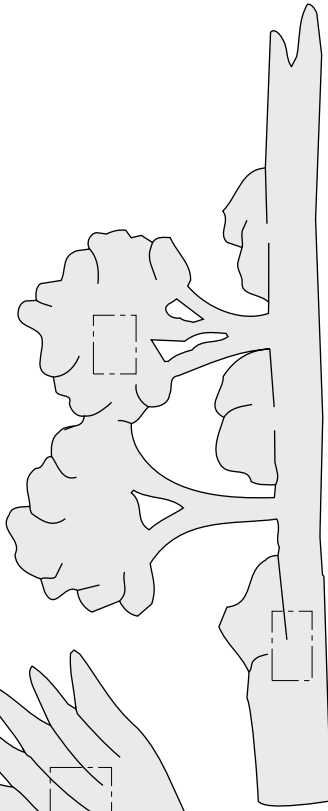

**Left Horizon**  
Stock: 1/16" - 1/8"  
Spacers: 1/8", cut 2

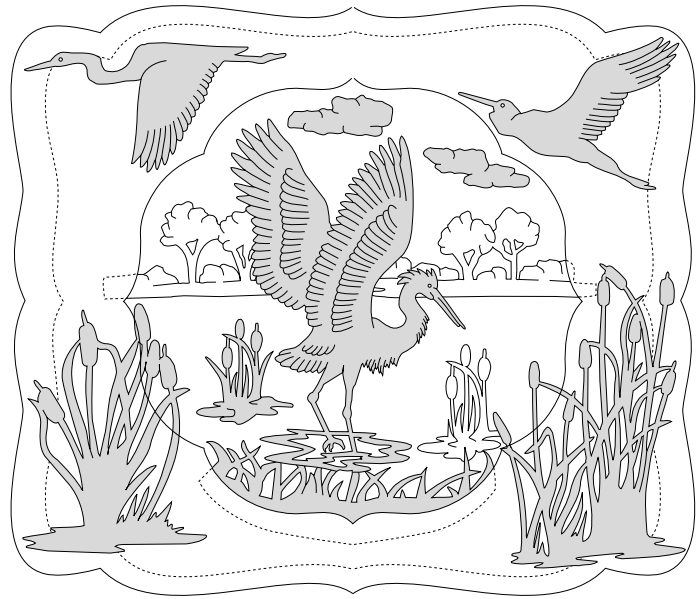

**Great Blue Heron**

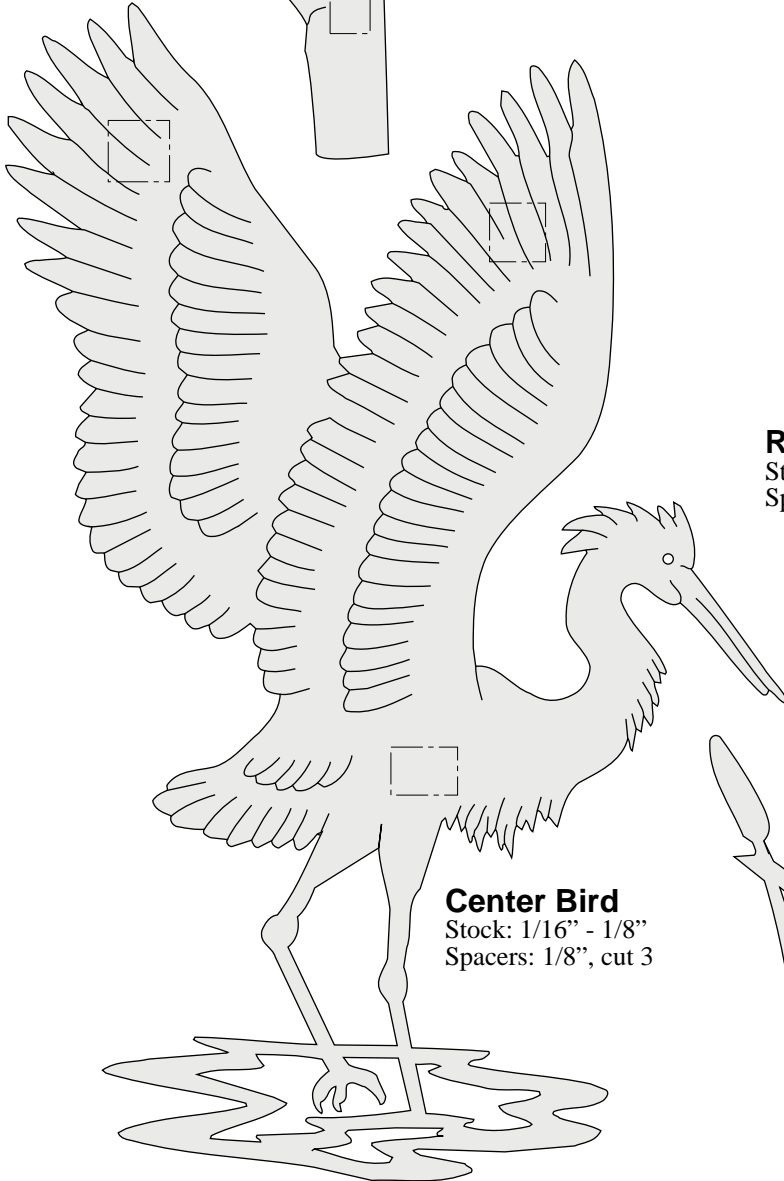

**Center Bird**  
Stock: 1/16" - 1/8"  
Spacers: 1/8", cut 3

**Right Front Cattails**  
Stock: 1/16" - 1/8"  
Spacers: 1/8", cut 3

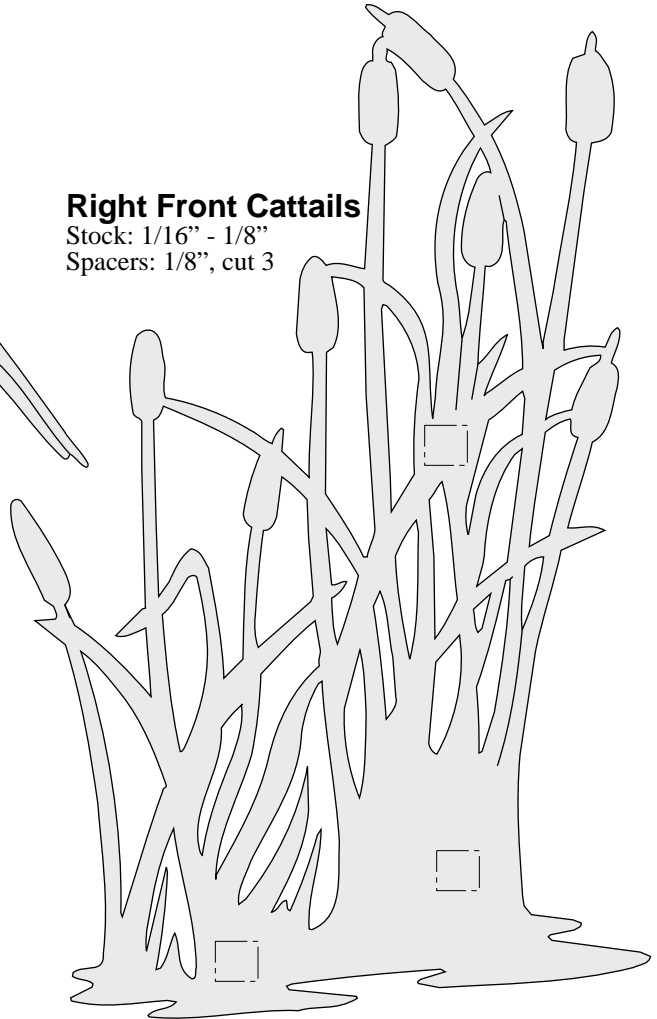

**Frame & Back**

Stock: 1/8" - 1/4", cut 1 each  
Left side

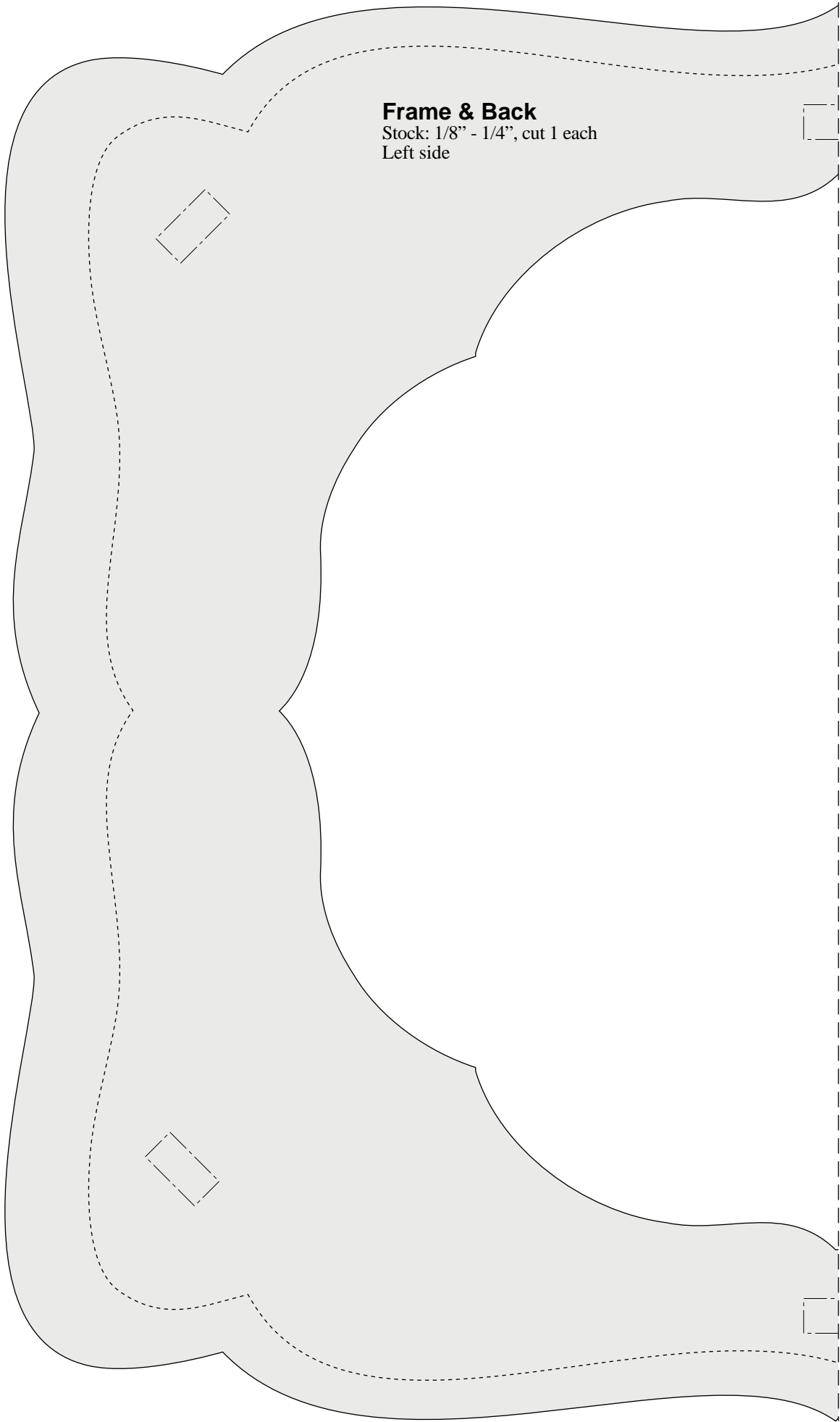

Pattern overlap line



Pattern overlap line

Cut 6 spacer blocks from 3/8" thick material to separate Frame from Back.

Right side

Cut on dashed line for Back

Cut on solid line for Frame only.

3/8" Frame spacer location



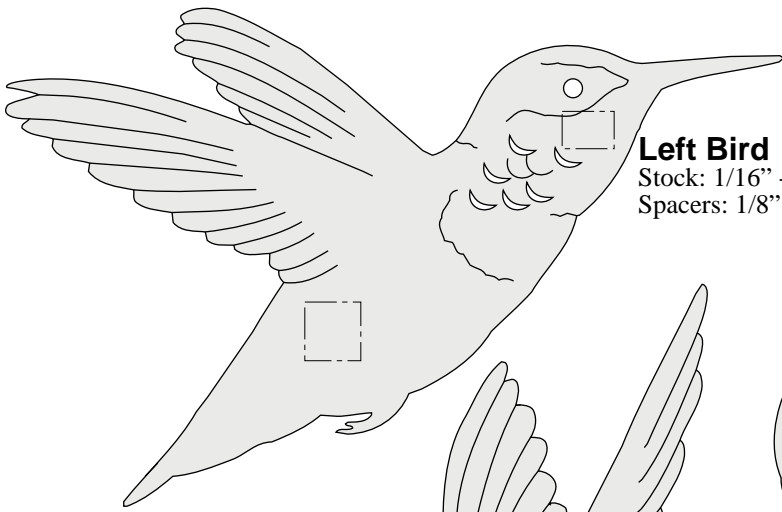

**Left Bird**  
Stock: 1/16" - 1/8"  
Spacers: 1/8", cut 2

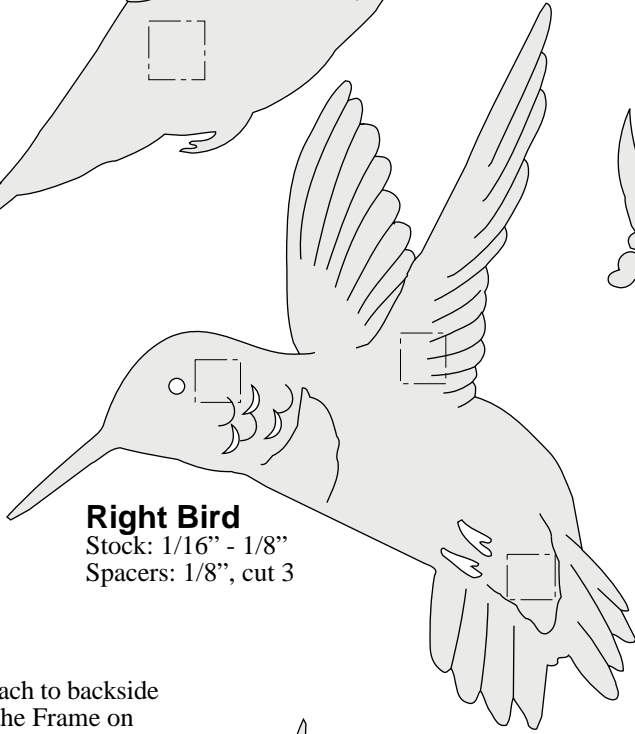

**Right Bird**  
Stock: 1/16" - 1/8"  
Spacers: 1/8", cut 3

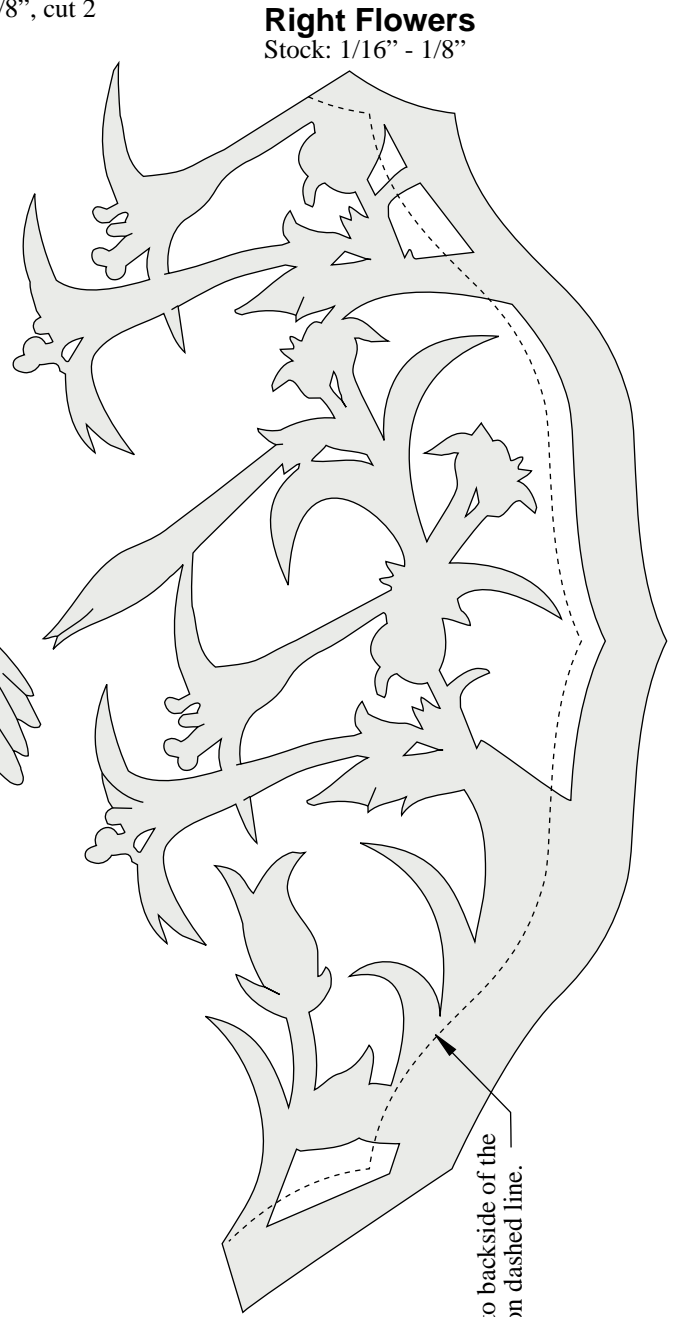

**Right Flowers**  
Stock: 1/16" - 1/8"

Attach to backside of the Frame on dashed line.

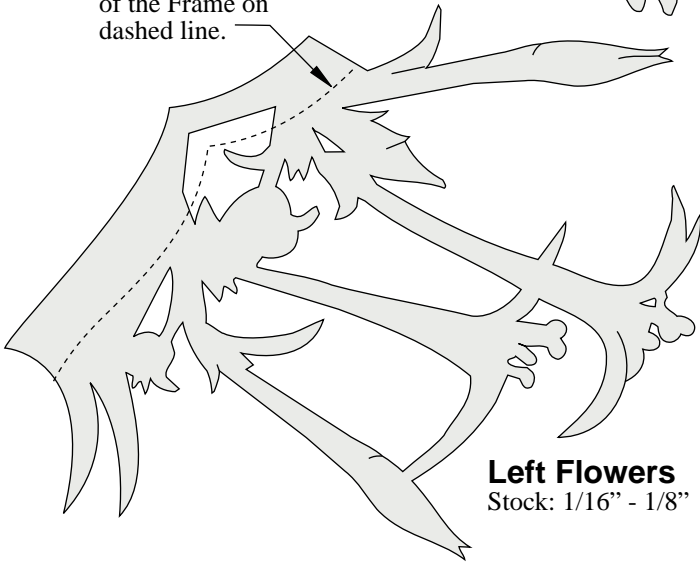

**Left Flowers**  
Stock: 1/16" - 1/8"

Attach to backside of the Frame on dashed line.

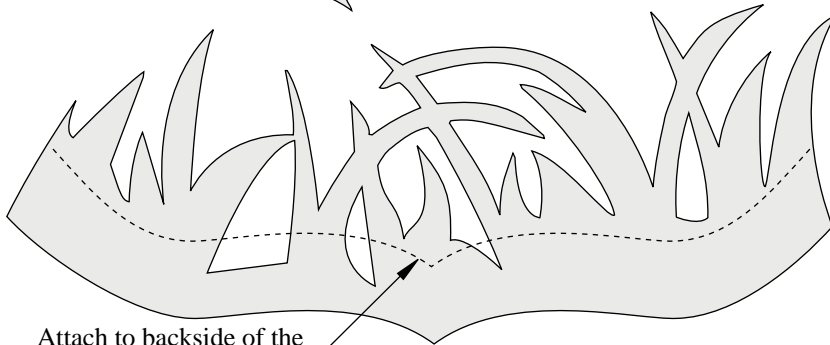

**Grass**  
Stock: 1/16" - 1/8"

Attach to backside of the Frame on dashed line.

**Cloud**

Stock: 1/16" - 1/8"  
Spacer: 1/8"

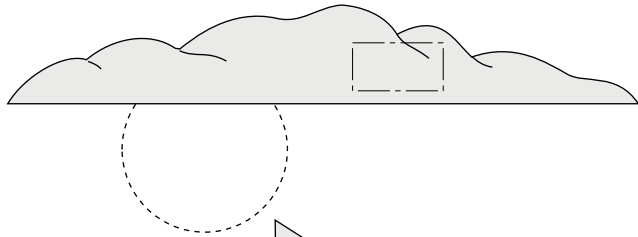

**Rufus Hummingbird**

**Horizon**  
Stock: 1/16" - 1/8"  
Spacer: 1/8", cut 4

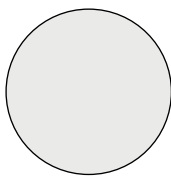
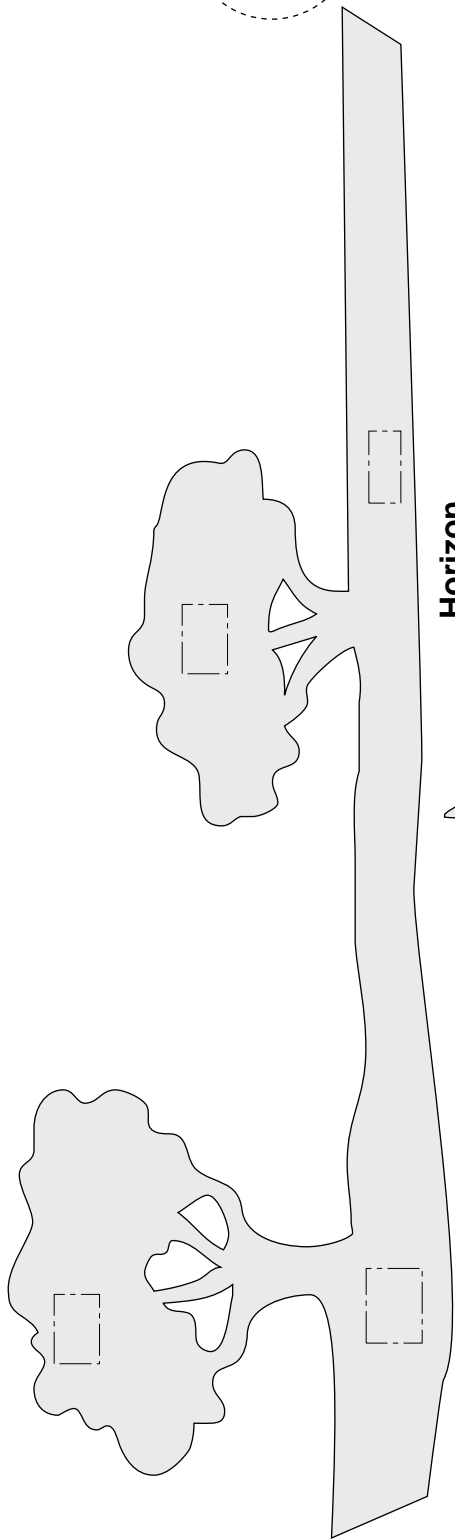

**Sun**

Stock: 1/16" - 1/8"

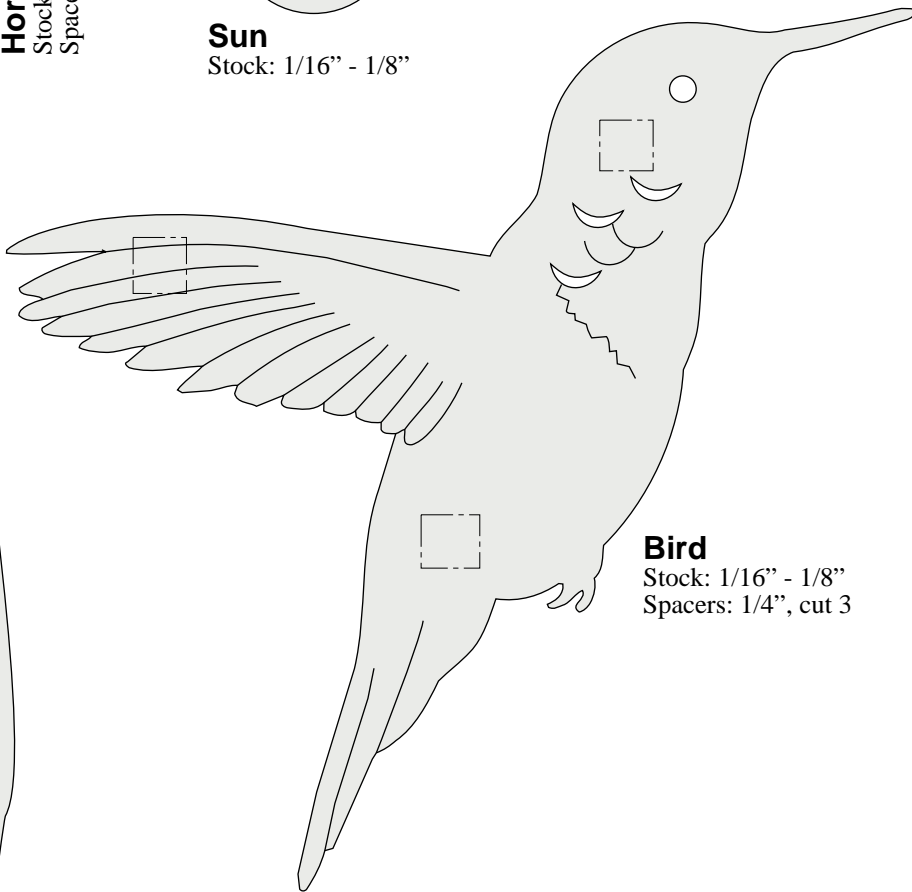

**Bird**

Stock: 1/16" - 1/8"  
Spacers: 1/4", cut 3

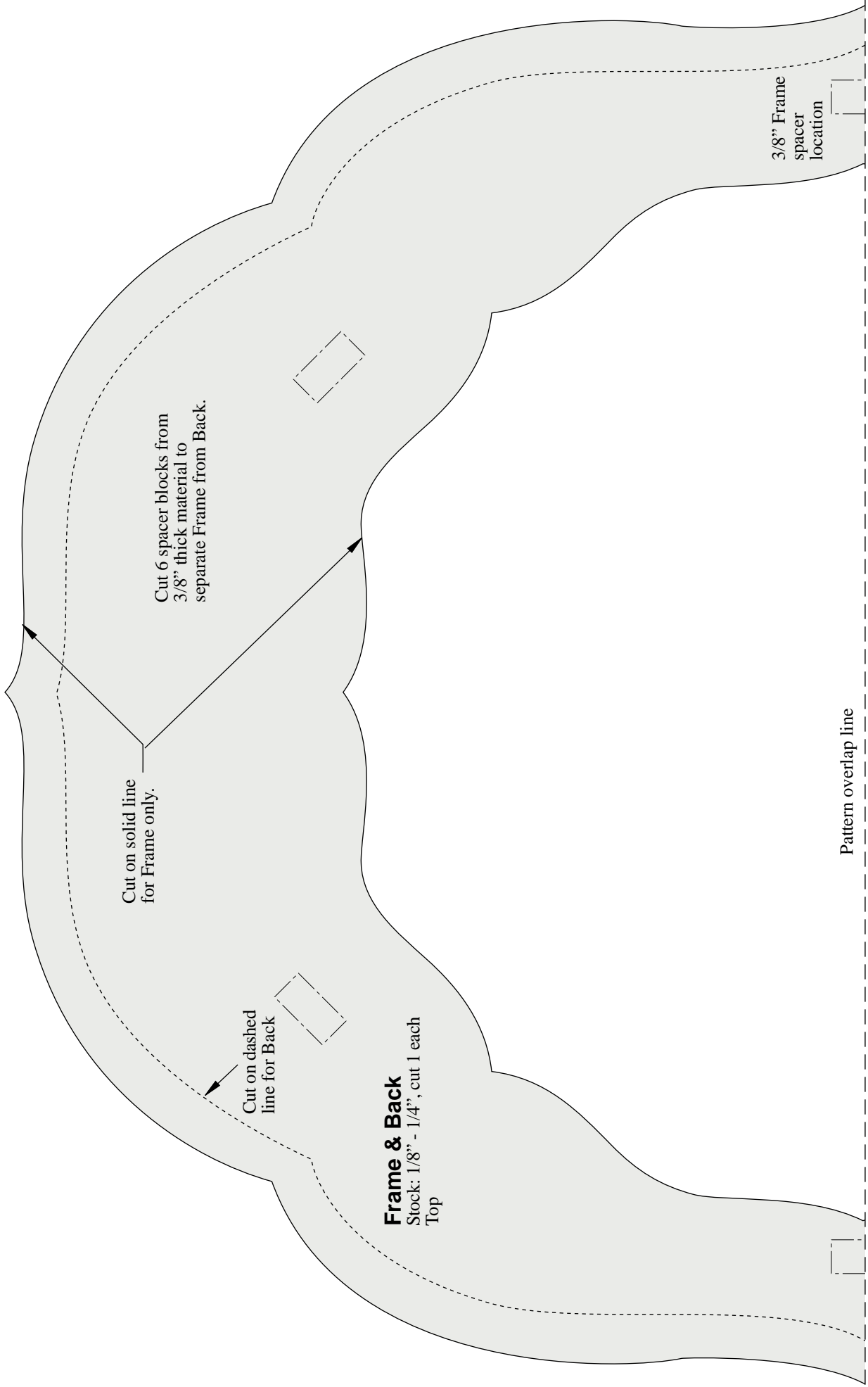

Cut on solid line for Frame only.

Cut 6 spacer blocks from 3/8" thick material to separate Frame from Back.

Cut on dashed line for Back

**Frame & Back**  
Stock: 1/8" - 1/4", cut 1 each  
Top

3/8" Frame spacer location

Pattern overlap line

Pattern overlap line

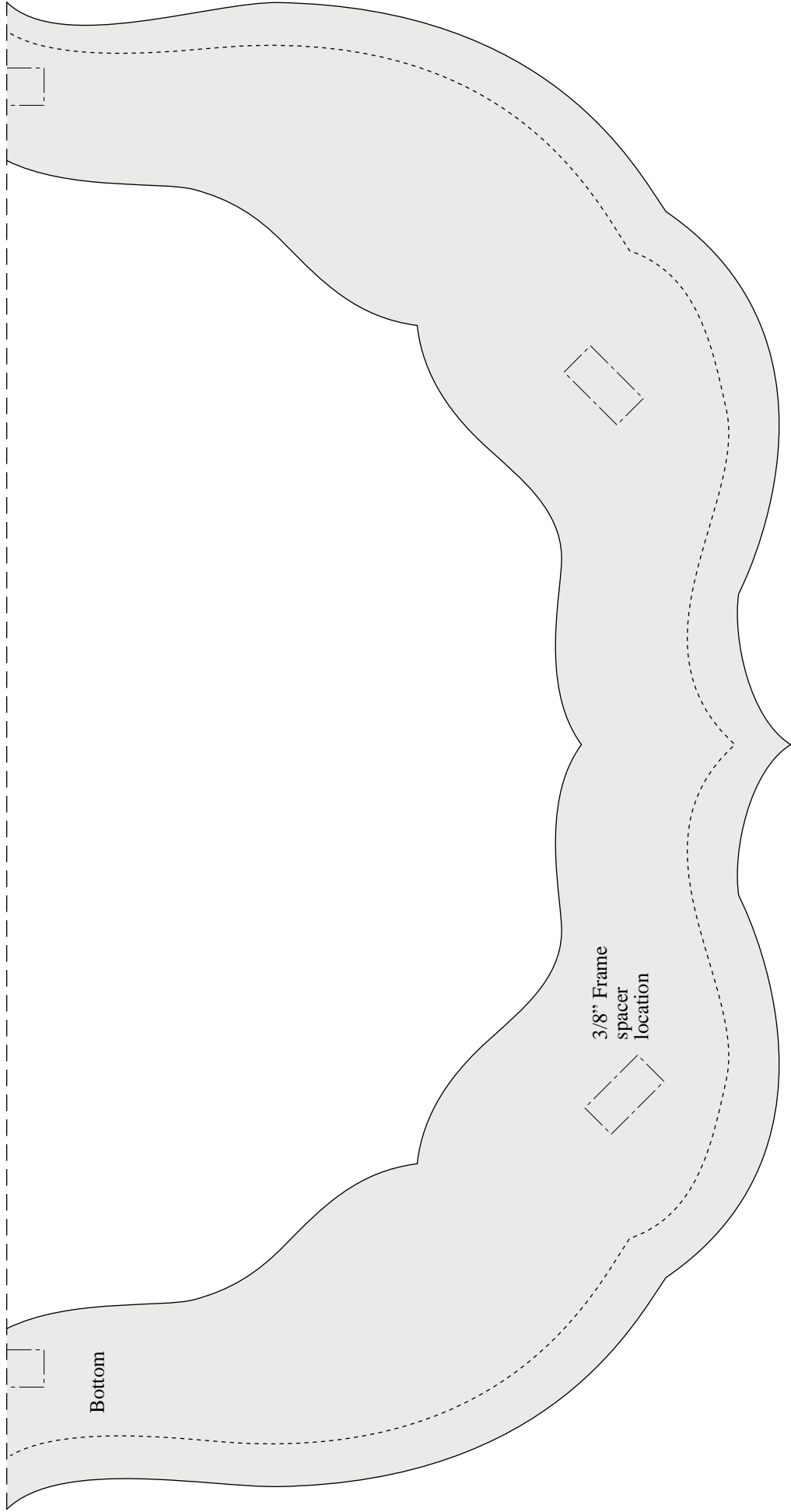

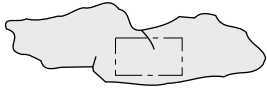

**Left Cloud**  
Stock: 1/16 - 1/8"  
Spacer: 1/8"



**Center Cloud**  
Stock: 1/16 - 1/8"

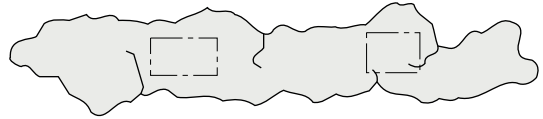

**Right Cloud**  
Stock: 1/16 - 1/8"  
Spacers: 1/8", cut 2

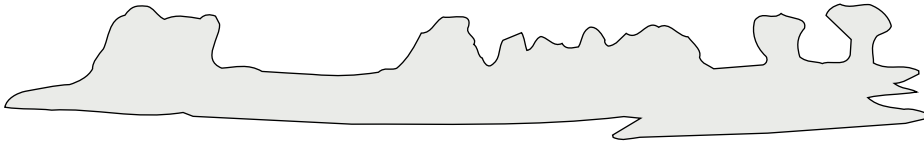

**Left Horizon**  
Stock: 1/16 - 1/8"

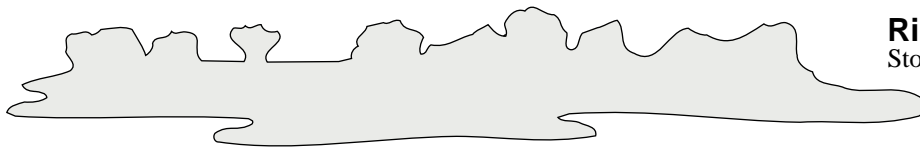

**Right Horizon**  
Stock: 1/16 - 1/8"

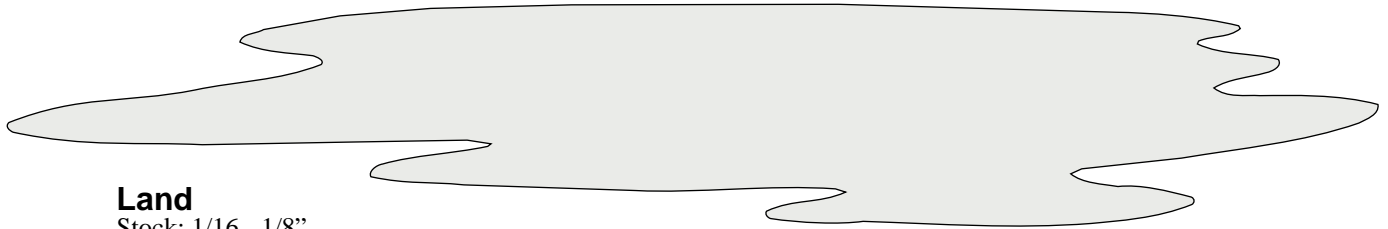

**Land**  
Stock: 1/16 - 1/8"

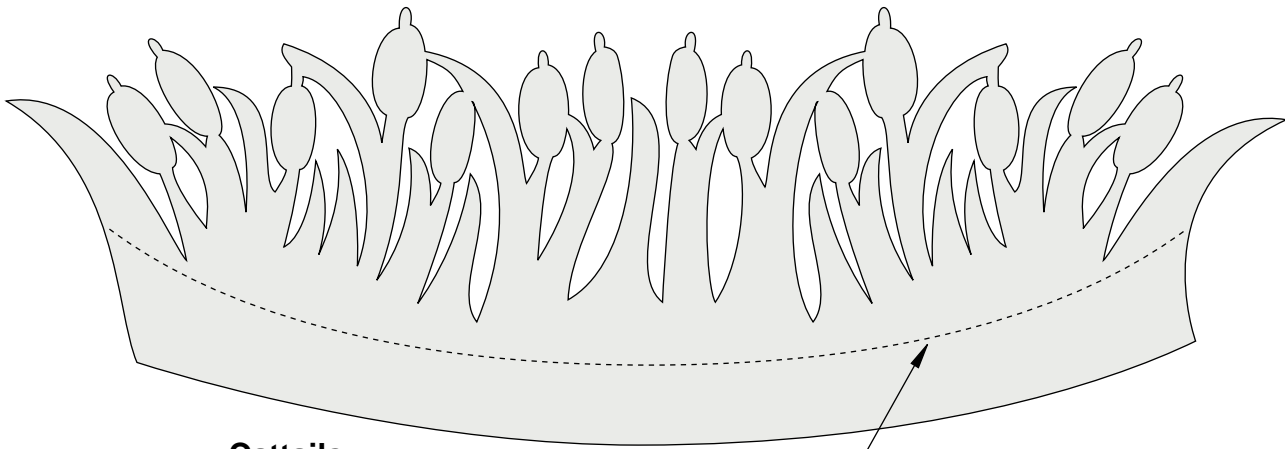

**Cattails**  
Stock: 1/16 - 1/8"

Attach to backside of the  
Frame on dashed line.

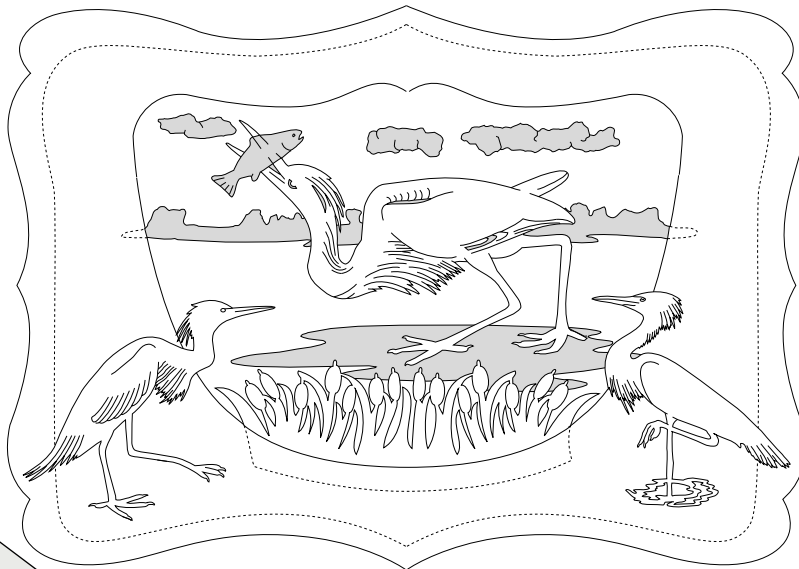

**Little Blue Heron**

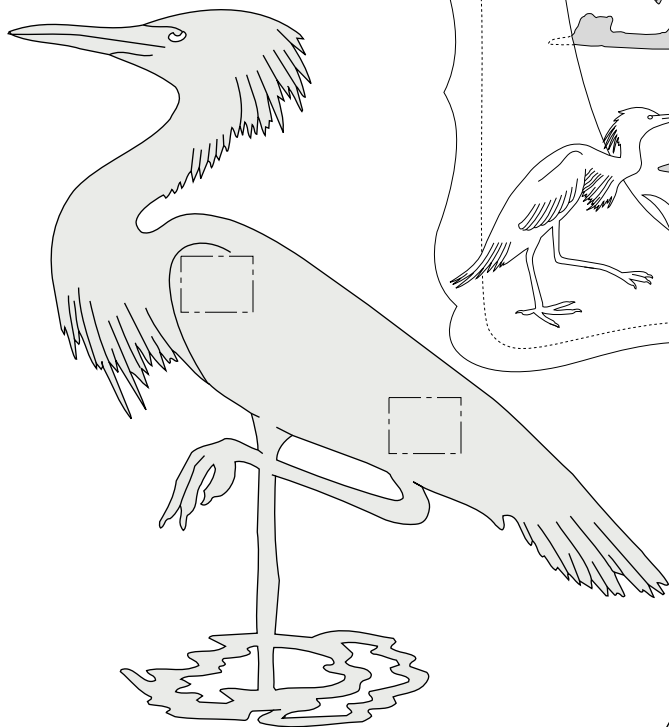

**Right Front Bird**

Stock: 1/16 - 1/8"  
Spacers: 1/8", cut 2

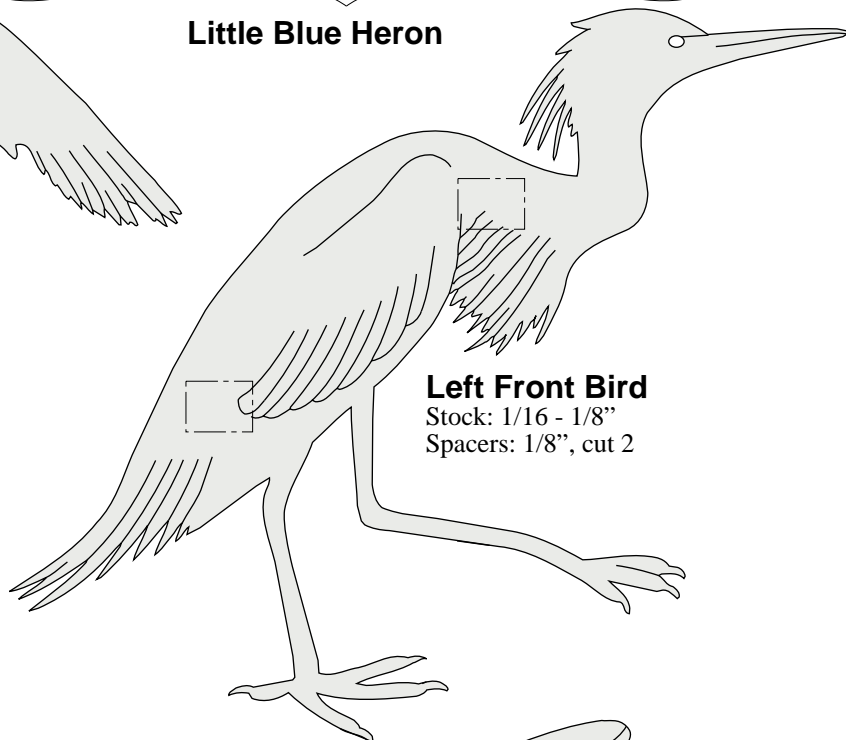

**Left Front Bird**

Stock: 1/16 - 1/8"  
Spacers: 1/8", cut 2

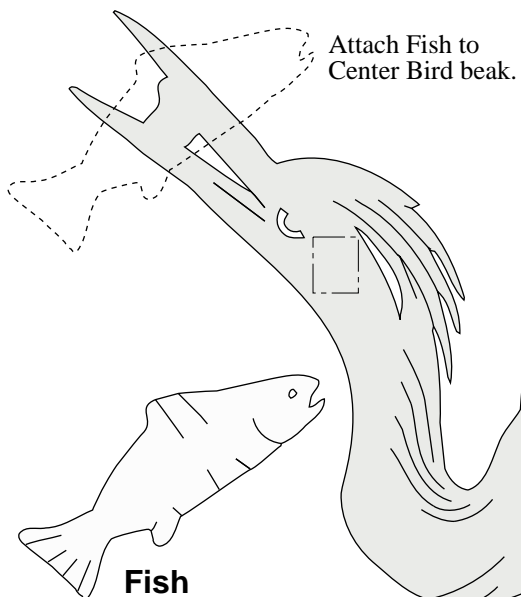

Attach Fish to  
Center Bird beak.

**Fish**

Stock: 1/16 - 1/8"

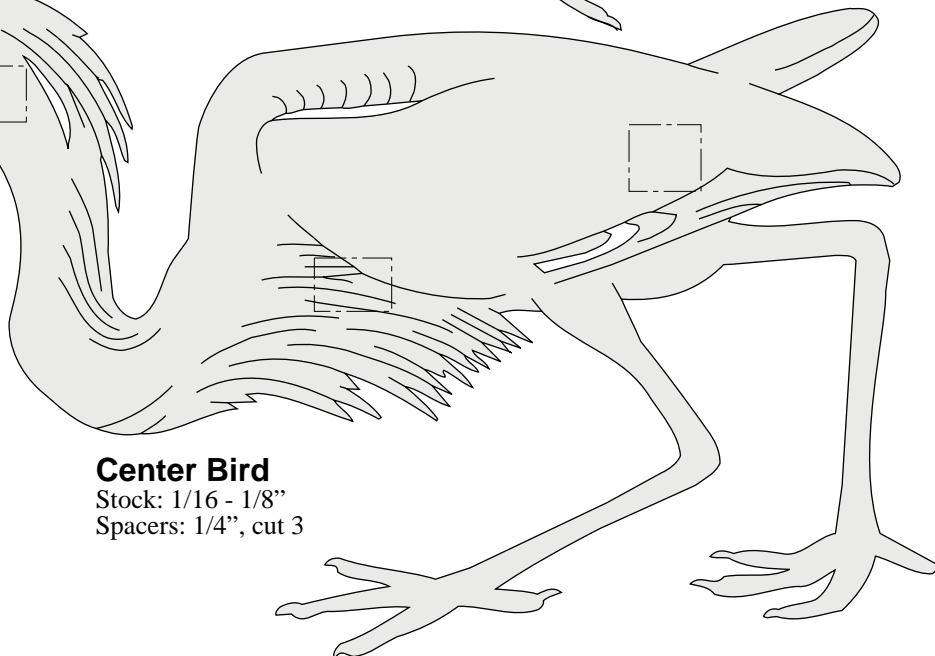

**Center Bird**

Stock: 1/16 - 1/8"  
Spacers: 1/4", cut 3

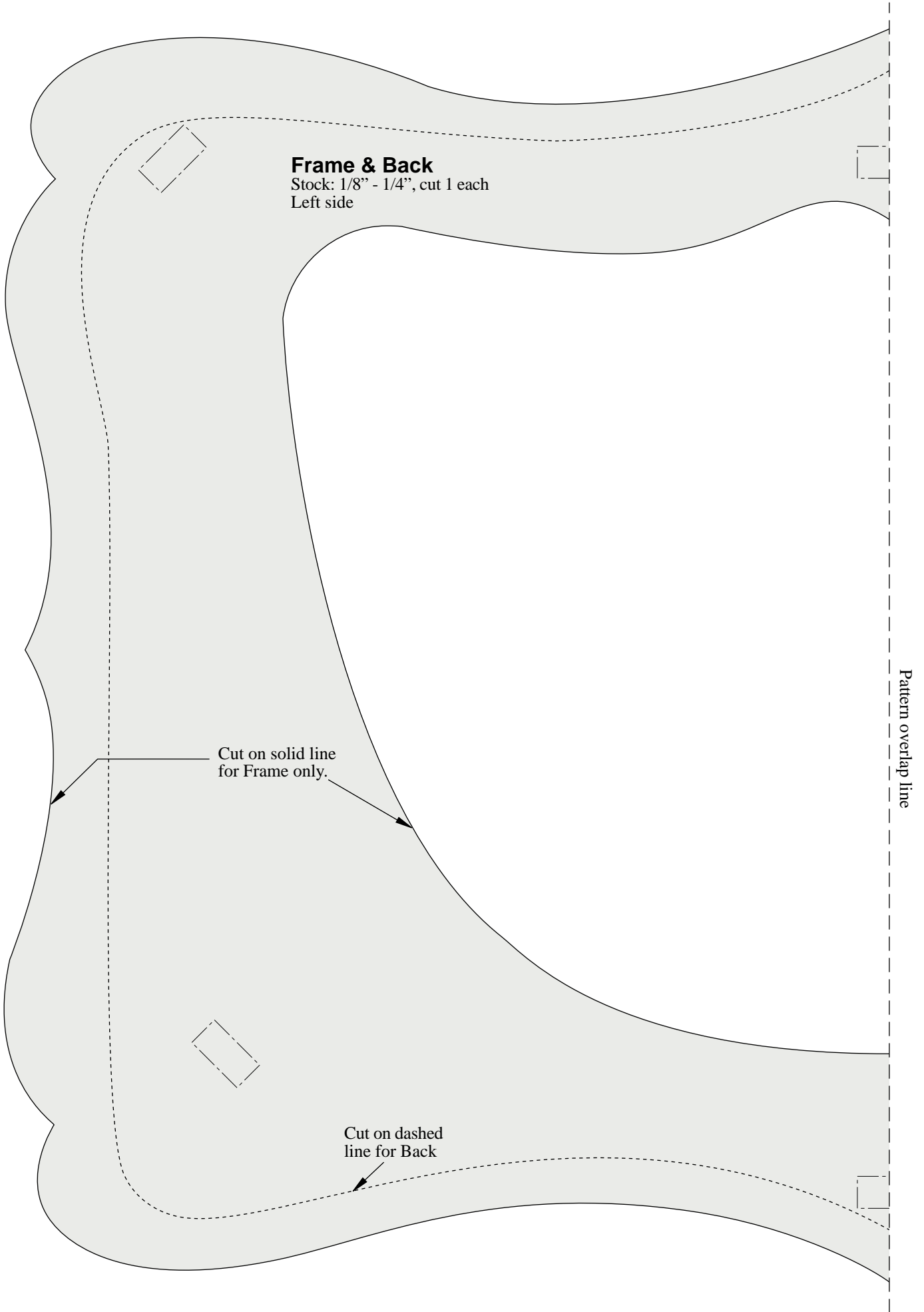

**Frame & Back**

Stock: 1/8" - 1/4", cut 1 each  
Left side

Cut on solid line  
for Frame only.

Cut on dashed  
line for Back

Pattern overlap line



Cut 6 spacer blocks from  
3/8" thick material to  
separate Frame from Back.

Right side

Pattern overlap line

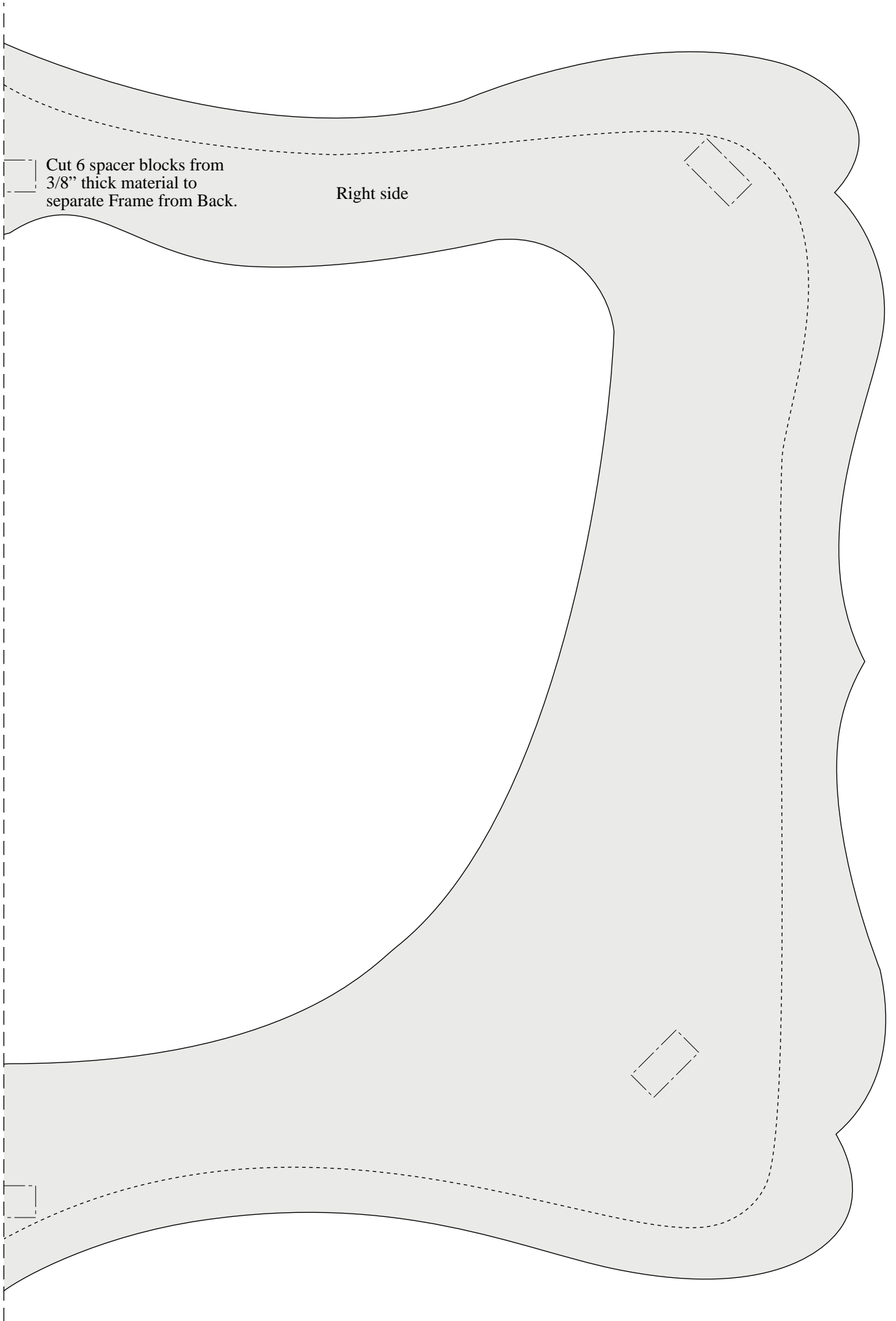

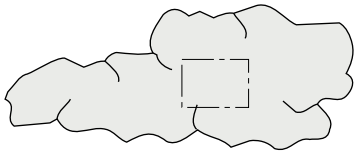

**Left Cloud**  
Stock: 1/16" - 1/8"  
Spacer: 1/8"

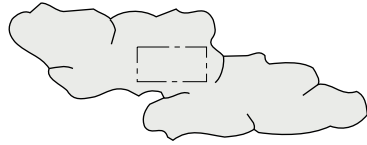

**Right Cloud**  
Stock: 1/16" - 1/8"  
Spacer: 1/8"

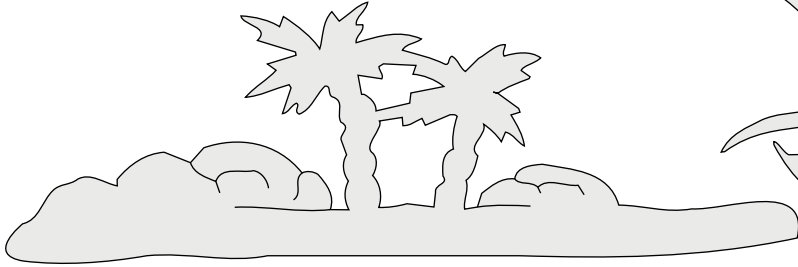

**Left Horizon**  
Stock: 1/16" - 1/8"

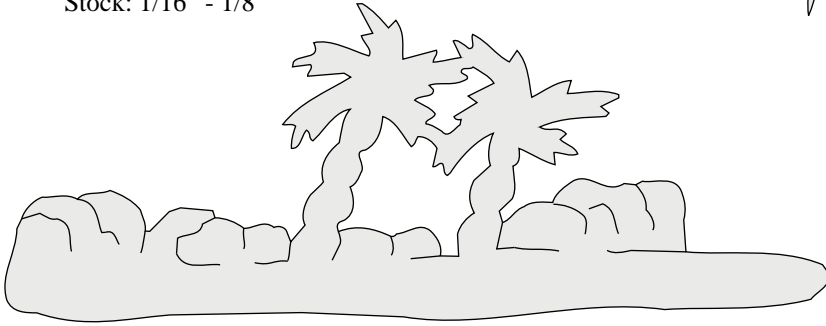

**Right Horizon**  
Stock: 1/16" - 1/8"

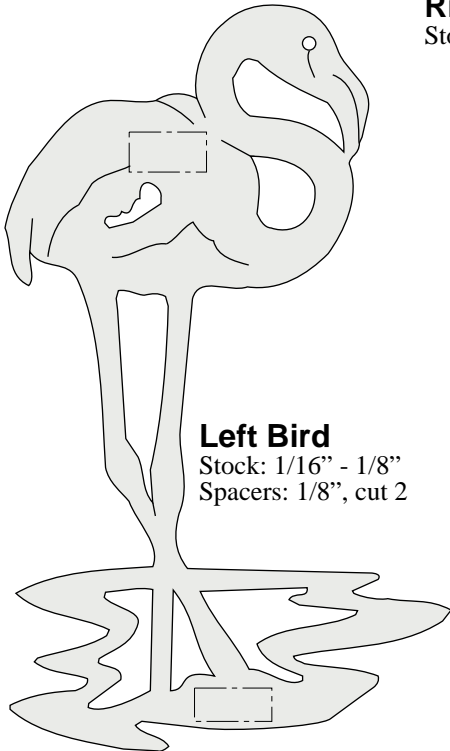

**Left Bird**  
Stock: 1/16" - 1/8"  
Spacers: 1/8", cut 2

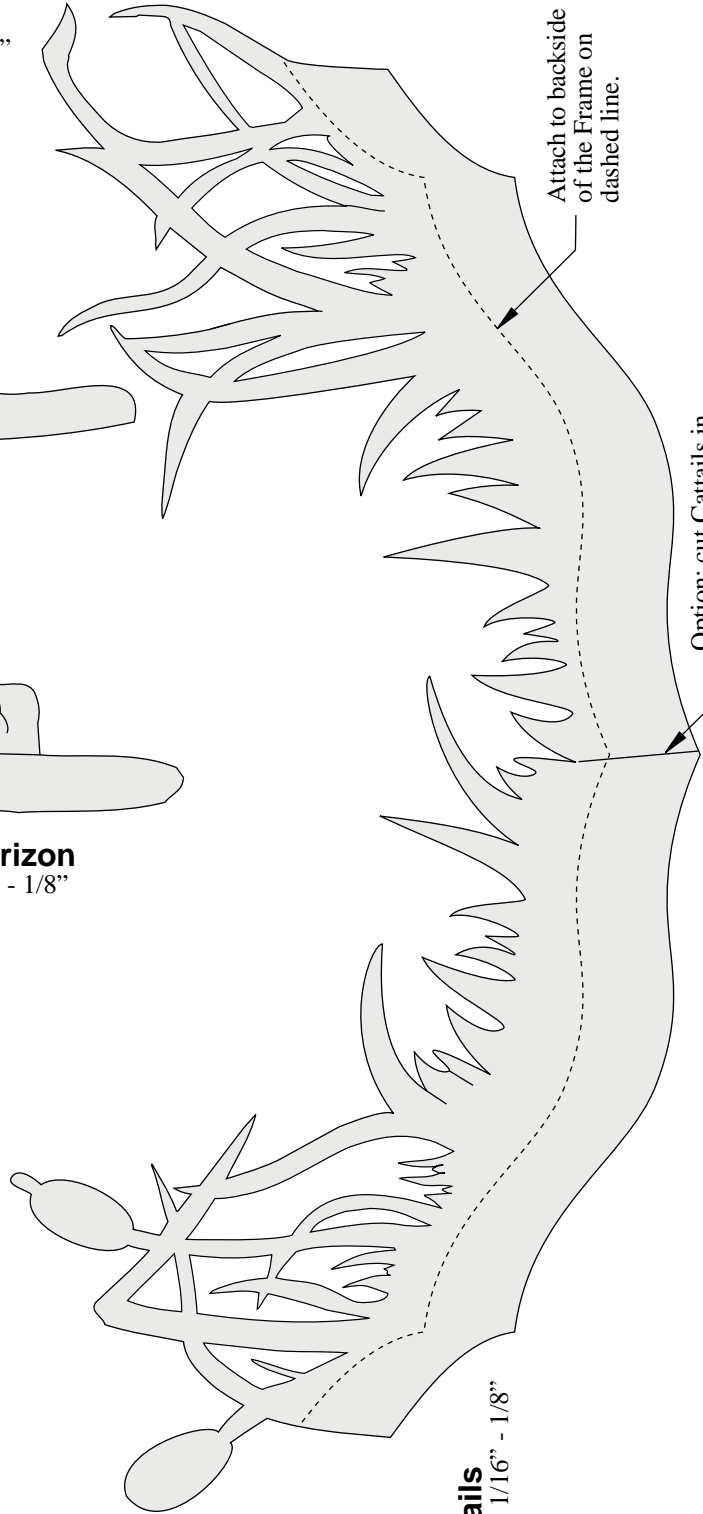

**Cattails**  
Stock: 1/16" - 1/8"

Attach to backside of the Frame on dashed line.

Option: cut Cattails in two pieces.

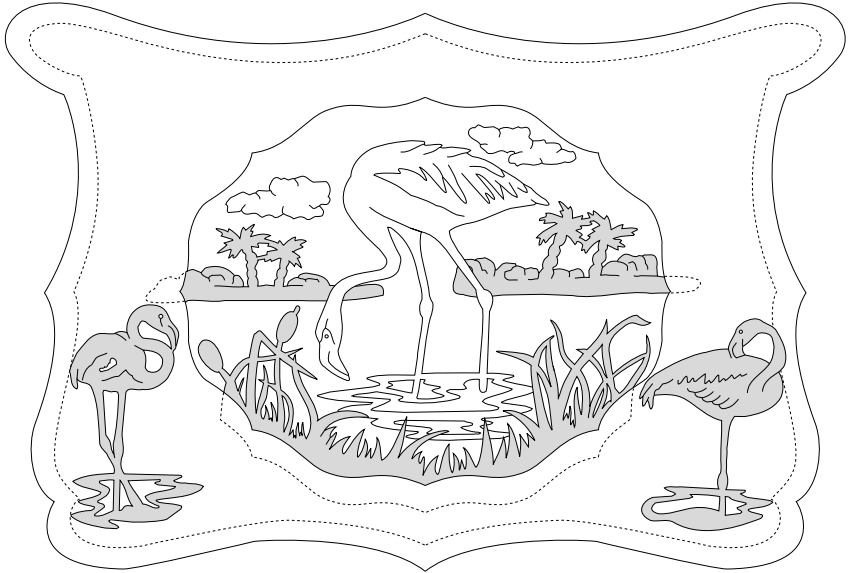

**Pink Flamingo**

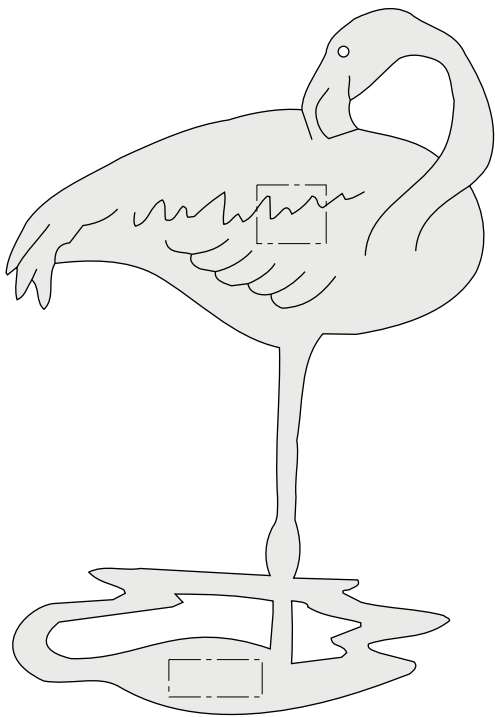

**Right Bird**

Stock: 1/16" - 1/8"  
Spacers: 1/8", cut 2

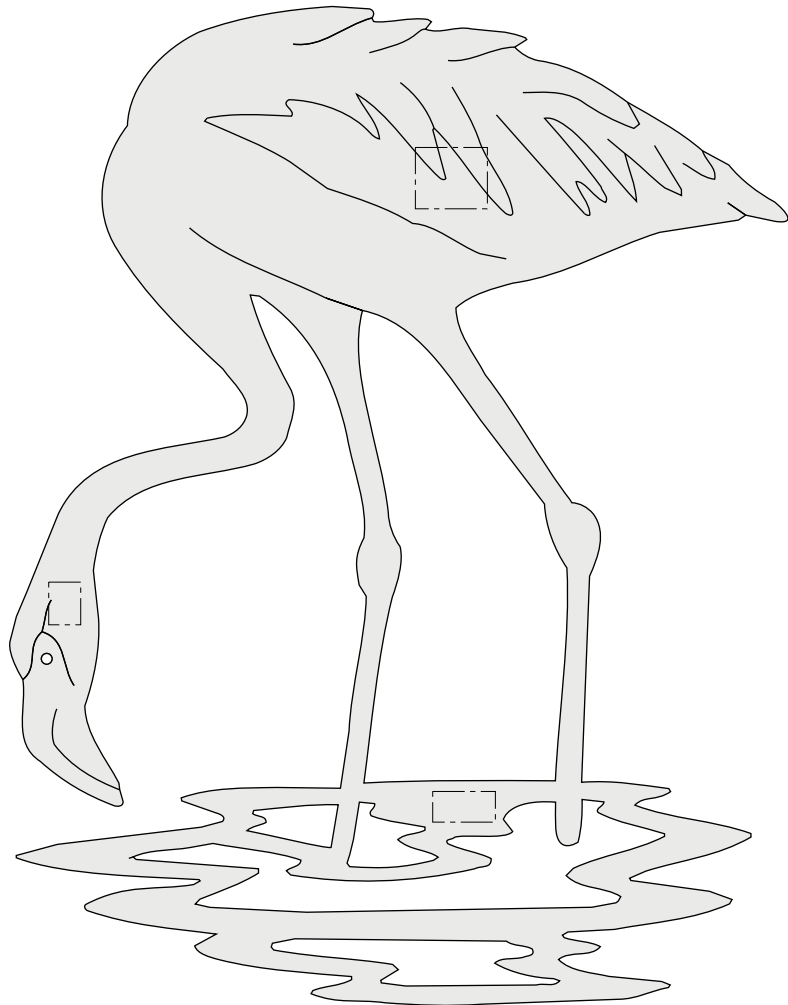

**Center Bird**

Stock: 1/16" - 1/8"  
Spacers: 1/8", cut 3

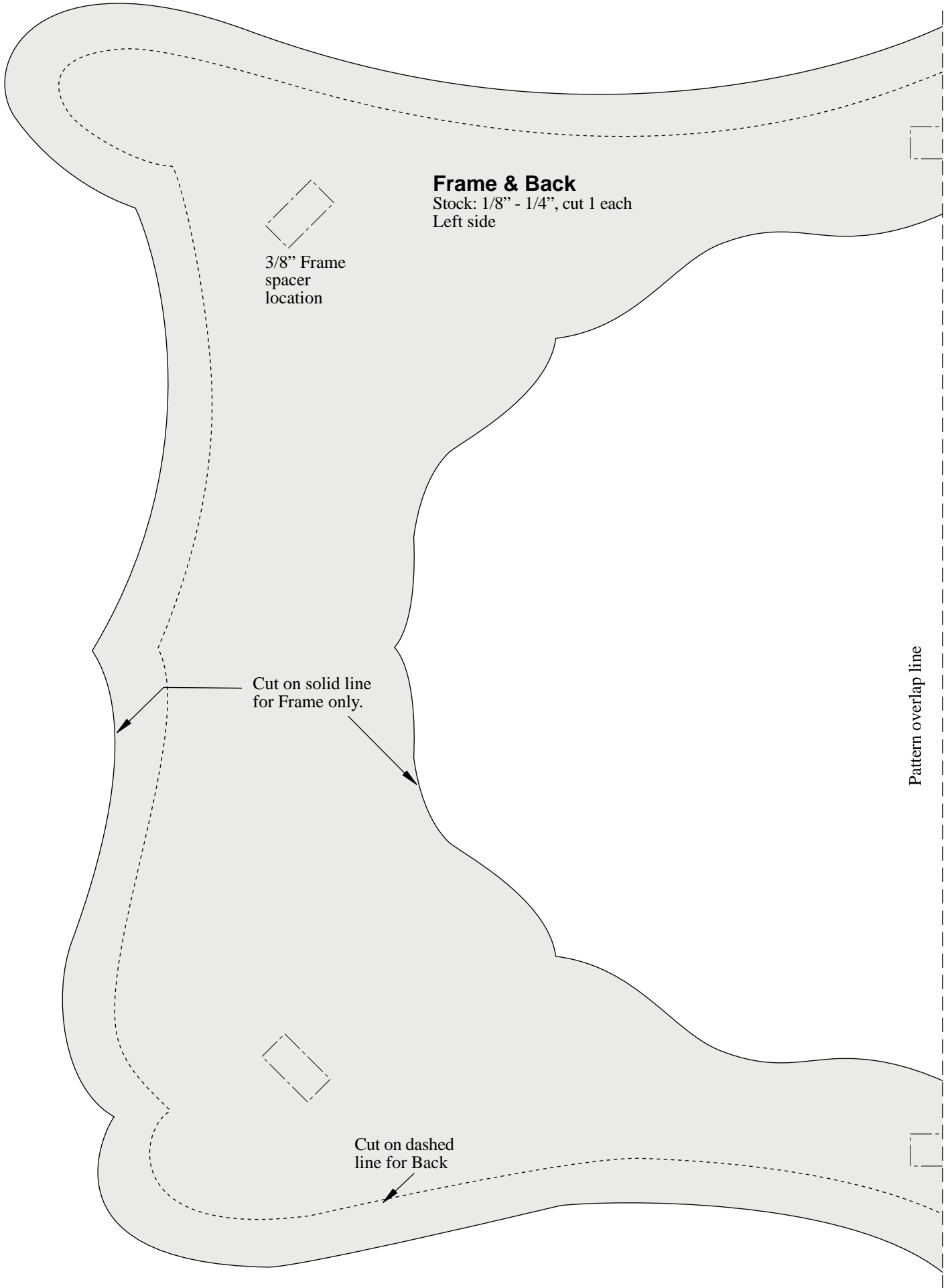

**Frame & Back**

Stock: 1/8" - 1/4", cut 1 each  
Left side

3/8" Frame  
spacer  
location

Cut on solid line  
for Frame only.

Cut on dashed  
line for Back

Pattern overlap line



Cut 6 spacer blocks from  
3/8" thick material to  
separate Frame from Back.

Right side

Pattern overlap line

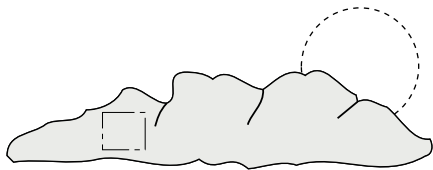

**Left Cloud**  
Stock: 1/16" - 1/8"  
Spacer: 1/8"

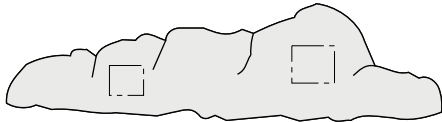

**Center Cloud**  
Stock: 1/16" - 1/8"  
Spacers: 1/8", cut 2

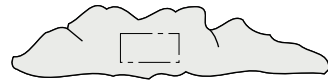

**Right Cloud**  
Stock: 1/16" - 1/8"  
Spacer: 1/8"

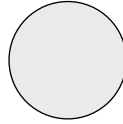

**Sun**  
Stock: 1/16" - 1/8"

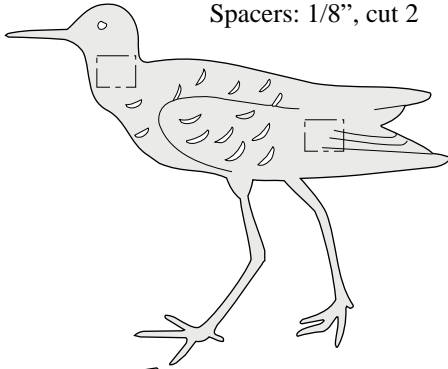

**Back Bird**  
Stock: 1/16" - 1/8"  
Spacers: 1/8", cut 2

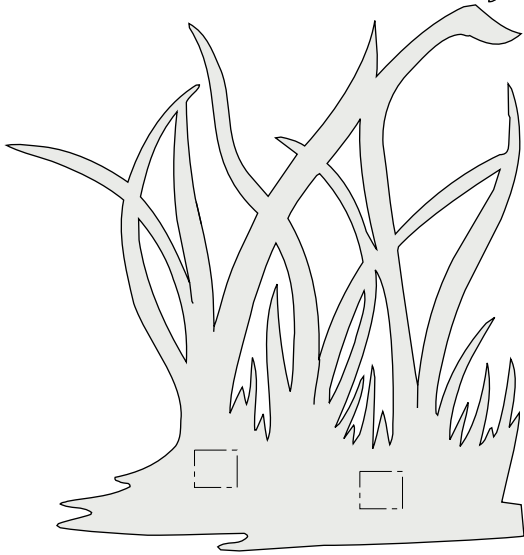

**Right Reeds**  
Stock: 1/16" - 1/8"  
Spacers: 1/4", cut 2

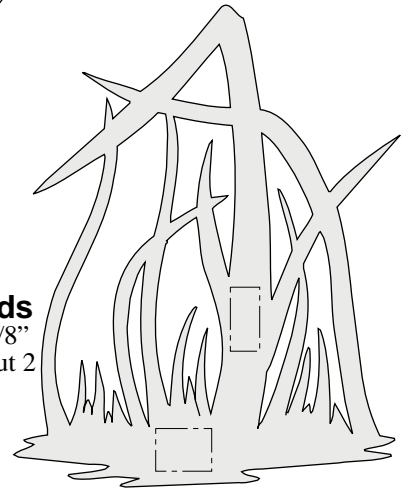

**Center Reeds**  
Stock: 1/16" - 1/8"  
Spacers: 1/8", cut 2

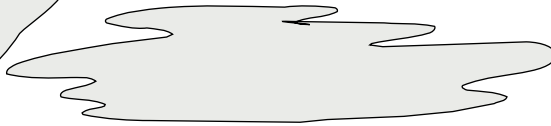
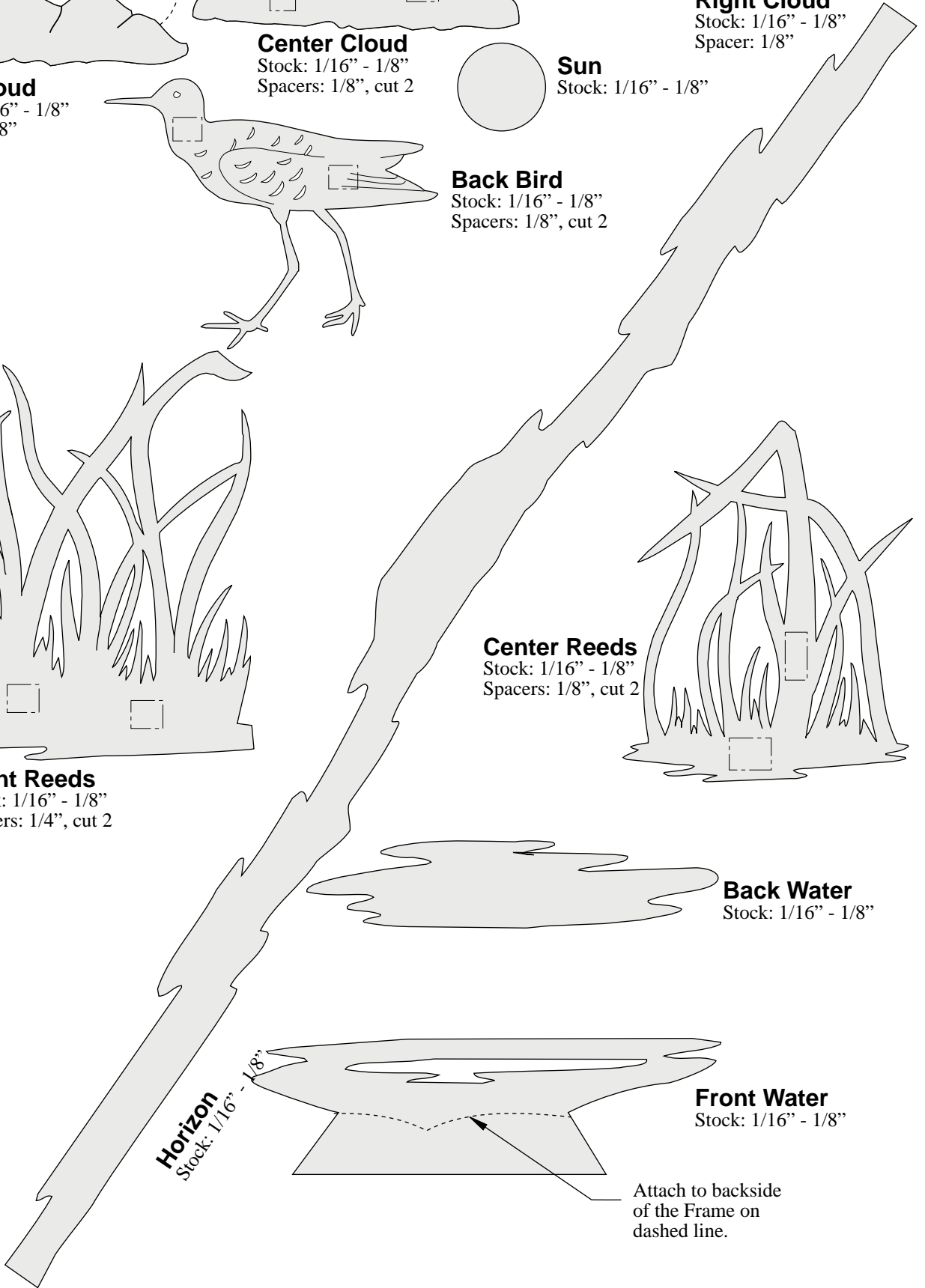

**Back Water**  
Stock: 1/16" - 1/8"

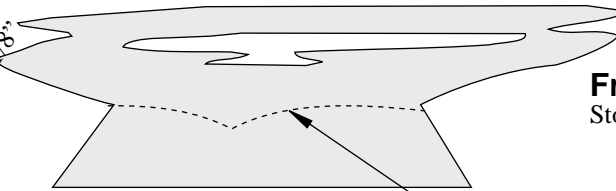

**Front Water**  
Stock: 1/16" - 1/8"

**Horizon**  
Stock: 1/16" - 1/8"

Attach to backside of the Frame on dashed line.

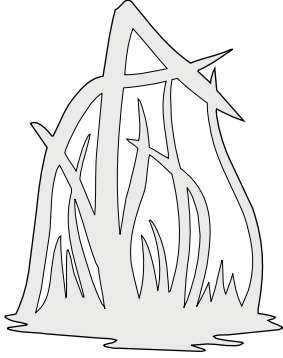

**Left Reeds**  
Stock: 1/16" - 1/8"

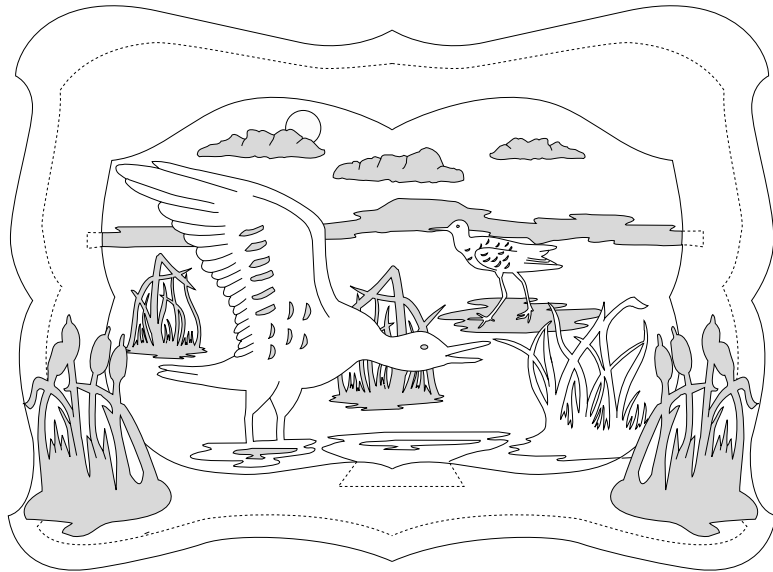

**Sandpiper**

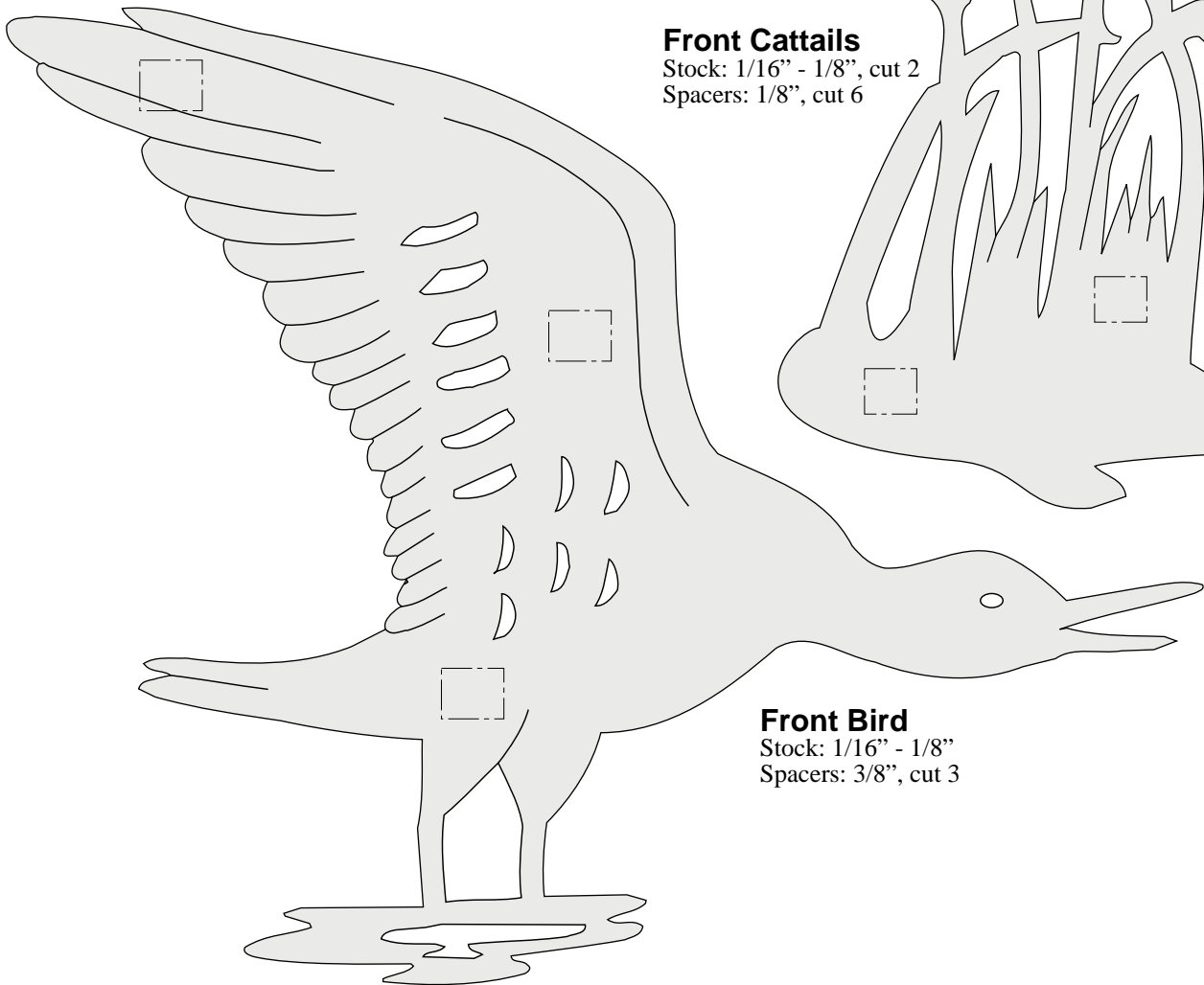

**Front Bird**  
Stock: 1/16" - 1/8"  
Spacers: 3/8", cut 3

**Front Cattails**  
Stock: 1/16" - 1/8", cut 2  
Spacers: 1/8", cut 6

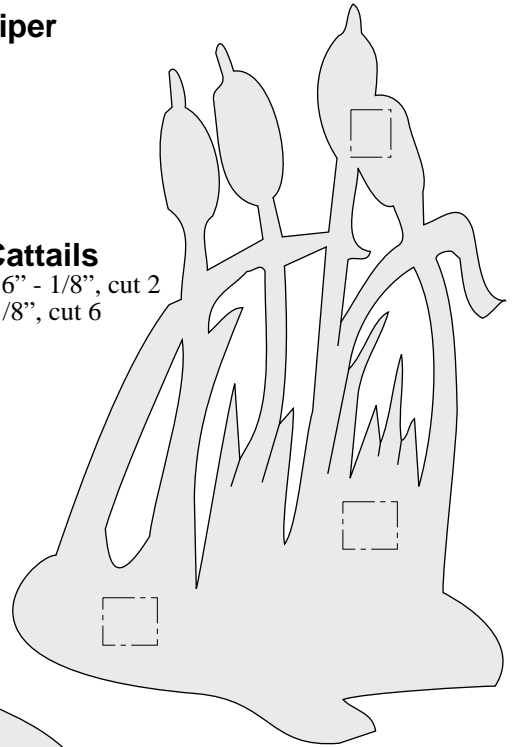

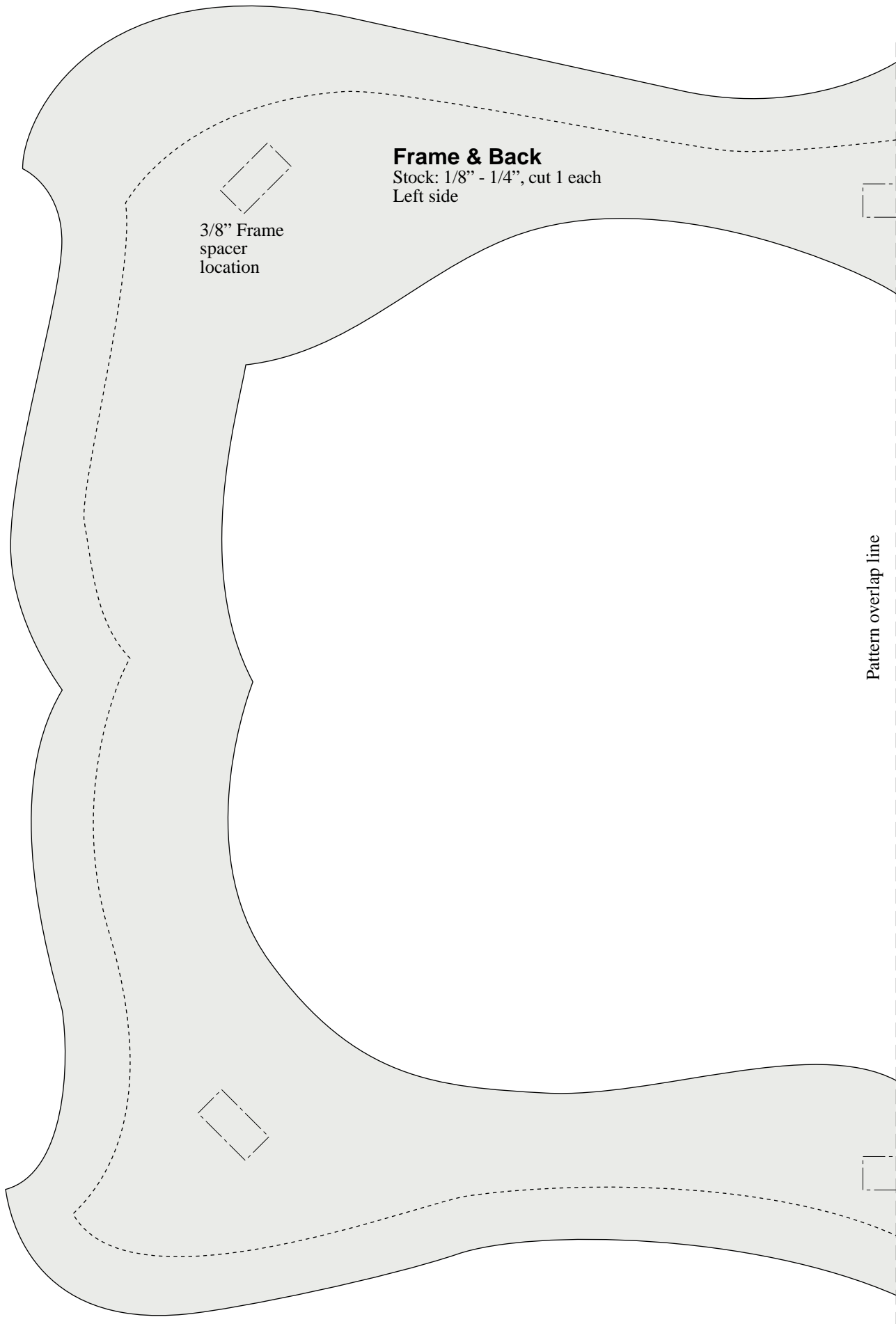

**Frame & Back**

Stock: 1/8" - 1/4", cut 1 each

Left side

3/8" Frame  
spacer  
location

Pattern overlap line



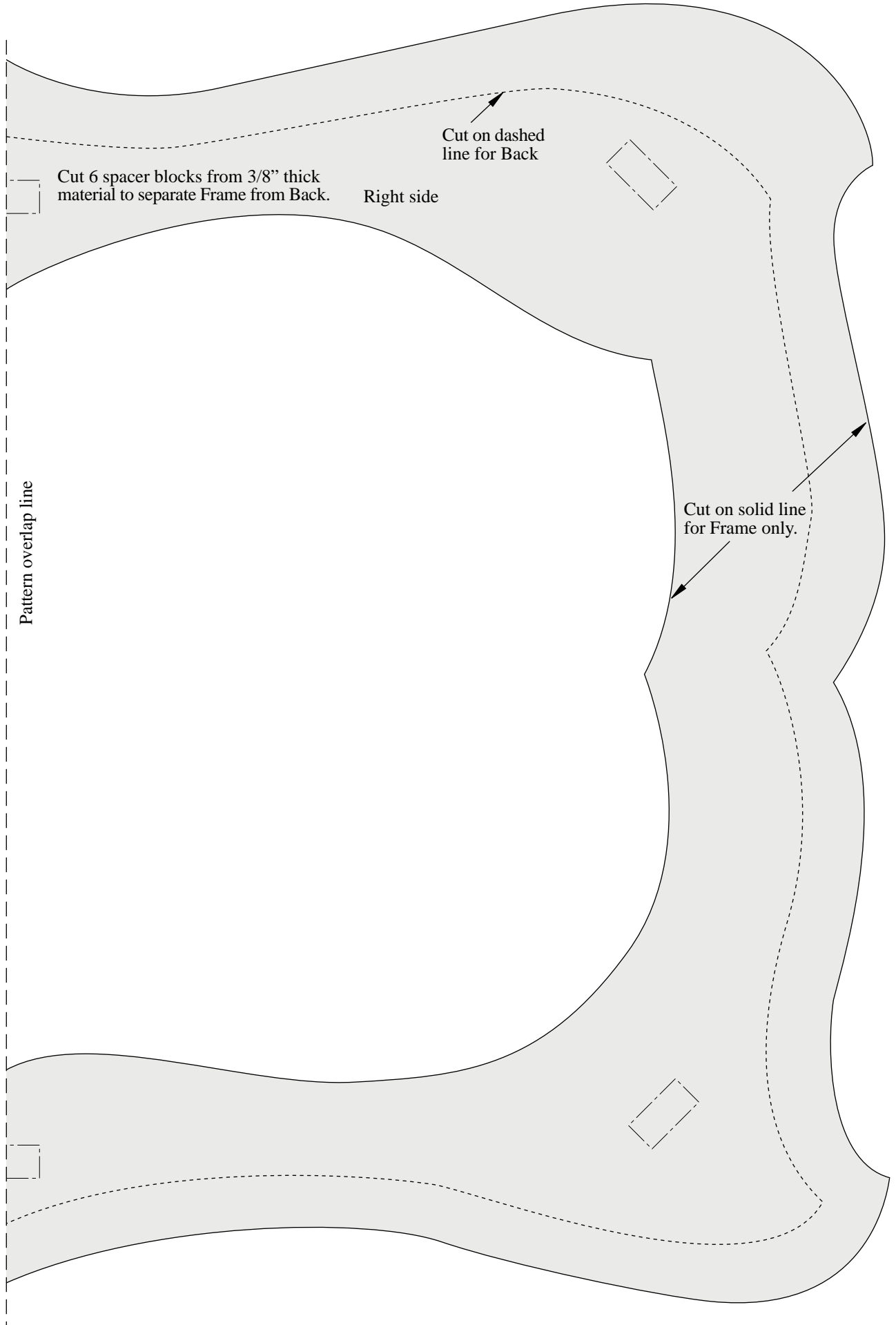

Pattern overlap line

Cut 6 spacer blocks from 3/8" thick material to separate Frame from Back.

Right side

Cut on dashed line for Back

Cut on solid line for Frame only.