

Patrick Spielman & Patricia Spielman

# SCROLL SAW PATTERN BOOK

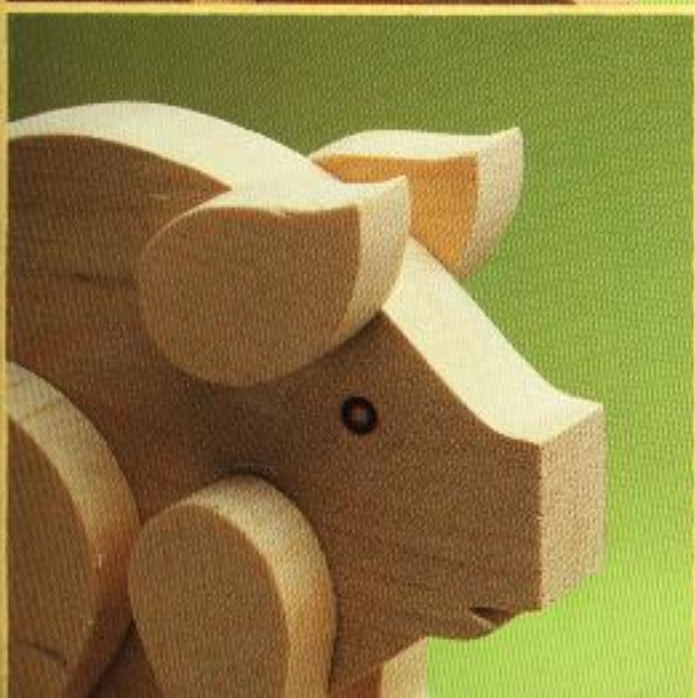

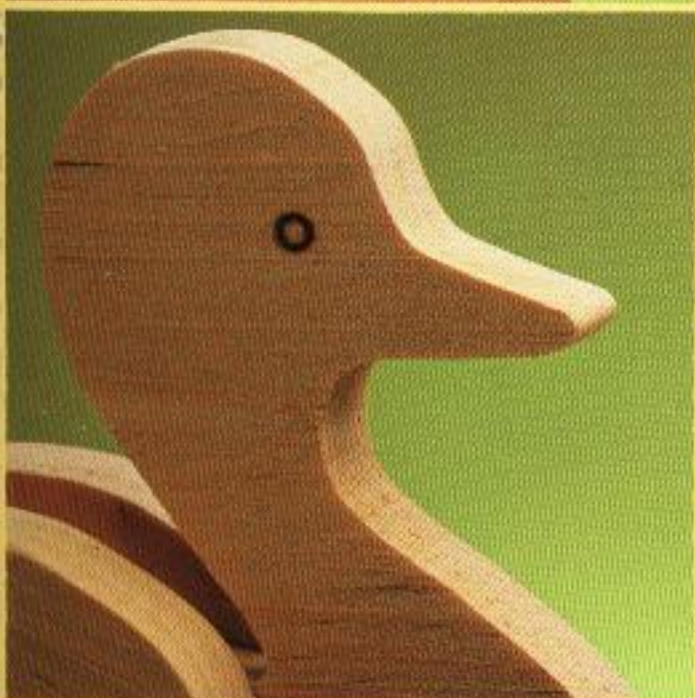

downloaded from [www.cro-wood.com](http://www.cro-wood.com)

# **SCROLL SAW PATTERN BOOK**

**Patrick Spielman &  
Patricia Spielman**

 **Sterling Publishing Co., Inc. New York**

## DEDICATION

To Robert, Sherri, and Sandra, our son and daughters, who also appreciate fine woodworking.

### Library of Congress Cataloging-in-Publication Data

Spielman, Patrick E.

Scroll saw pattern book.

Includes index.

I. Jig saws. 2. Woodwork. I. Spielman, Patricia.

II. Title.

TT186.S674 1986 745.51 86-14358  
ISBN 0-8069-4772-1 (pbk.)

Copyright © 1986 by Patrick and Patricia Spielman

Published by Sterling Publishing Co., Inc.

387 Park Avenue South, New York, N.Y. 10016

Distributed in Canada by Sterling Publishing

% Canadian Manda Group, P.O. Box 920, Station U

Toronto, Ontario, Canada M8Z 5P9

Distributed in Great Britain and Europe by Cassell PLC

Artillery House, Artillery Row, London SW1P 1RT, England

Distributed in Australia by Capricorn Ltd.

P.O. Box 665, Lane Cove, NSW 2066

*Manufactured in the United States of America*

*All rights reserved*

# Table of Contents

ACKNOWLEDGMENTS	5
INTRODUCTION	6
<b>Patterns</b>	
Country Cutouts	10
Flowers/Leaves/Fruit	35
Creatures of the Deep	44
Birds	50
Key Racks	74
Interlocking Trees/Corner Shelves	77
Man's Best Friends	84
Mini-Animal Cutouts	87
Belt Hook Designs	90
Cat and Flowers	92
Dimensional Animal Cutouts	93
Refrigerator Magnets/"Pets on a Stick"	98
More Friendly Creatures	103
Napkin Rings/Puzzles	108
Heart Wreath/Candle Holders	136

Jewelry/Ornaments	138
Candle Holders/Pegboards/Brackets	150
Picture Frames/Shelves	172
Recess/Relief/Silhouette/Line Work	180
Marquetry and Inlays	192
Lamp Assembly	210
Compound Sawing	219
Signboards	226
ABOUT THE AUTHORS	254
CURRENT BOOKS BY PATRICK SPIELMAN	255
INDEX	256

## ACKNOWLEDGMENTS

We thank Walter Schutz for providing us with some good design ideas. The silhouette patterns on pages 186–191 are adaptations of designs from his collection of scroll sawings made by an unknown New York artist. Thanks to Sherri Spielman for her help with the project painting and photography. We especially prize the designs and cutouts perfected by our son, Bob Spielman, which have become some of our most popular projects.

Finally, we express our sincerest gratitude to our friend and employee, Julie Kiehnau, who expertly cut out many of the test projects and other designs. Her speed and skill with a scroll saw are especially valued, as are her excellent typing and “store-keeping” abilities.

Patrick and Patricia Spielman  
Spielmans Wood Works

# Introduction

One of the problems common to all scroll-saw users is the difficulty of finding good, inexpensive, and easy-to-copy project patterns. It is with this in mind and the urging of magazine and book editors, scroll-saw manufacturers, and our woodworking friends that we have assembled this book of patterns.

This selection of over 450 designs includes ideas for making household accessories such as wall plaques, pegboards, candle holders, and ornaments. Also included are many of the currently popular "country cutouts," puzzles, and projects incorporating the always delightful heart design. (Someone once told us, "If you want it to sell, put a heart on it." That bit of advice has proven to be true.)

There are many great projects in this selection that are easy for the beginner to make successfully. There are also a good number of somewhat-more-complex patterns intended for the experienced craftsman and hobbyist. Many of the basic patterns are ideal for those individuals who enjoy woodburning (Illus. 1), painting (Illus. 2), stencilling, applying decals, and/or adding other individual touches. These decorative accents create beautiful household accessories and make great gifts. (Incidentally, a soft-tip marker (Illus. 3) can sometimes be used to color wood cutouts,

but remember, it has a tendency to bleed on some softwoods.) The different ways of implementing these patterns into completed projects are limited only by the imagination.

A scroll saw is the only tool needed to complete most of the projects. However, some also require the use of a hand or electric drill. It should also be noted that many of the designs and patterns here can also be cut out with a band saw.

Several full-size alphabets and number patterns are included. These will be useful for making wooden signs, nameplates, and house numbers. If you are interested in making wood signs, two books worth reading are: *Making Wood Signs* and *Alphabets and Designs for Wood Signs*. Both are published by Sterling Publishing Co.

The advanced craftsman will find some patterns for fretwork shelves, shelf brackets, picture frames, and compound sawing projects. There is also an abundance of ideas for fancy scroll-saw inlays, segmented pictures, and marquetry designs. Many patterns can be used simply as a starting point for the creative woodworker. If, for example, you need a leaf design for an inlaid jewelry box, you'll find some design ideas here, but you can expand on these designs.



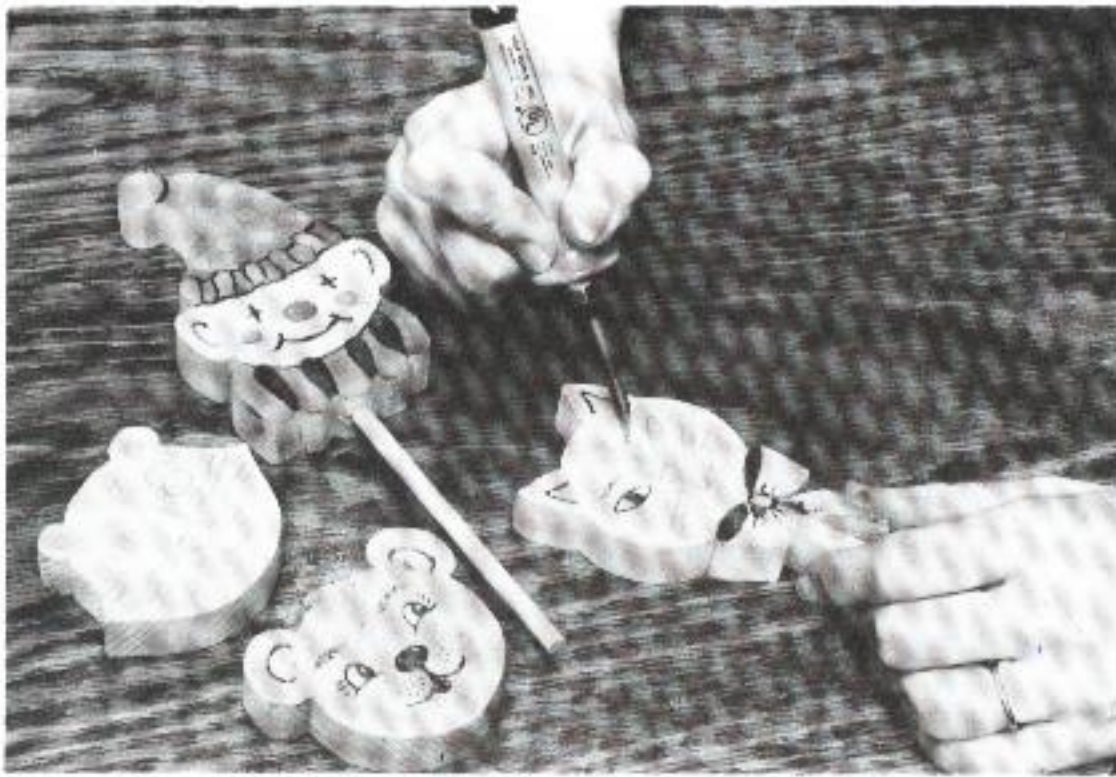

*Illus. 1. Some details can be outlined with a woodburning tool.*



*Illus. 2. You can add a touch of color with craft paint.*

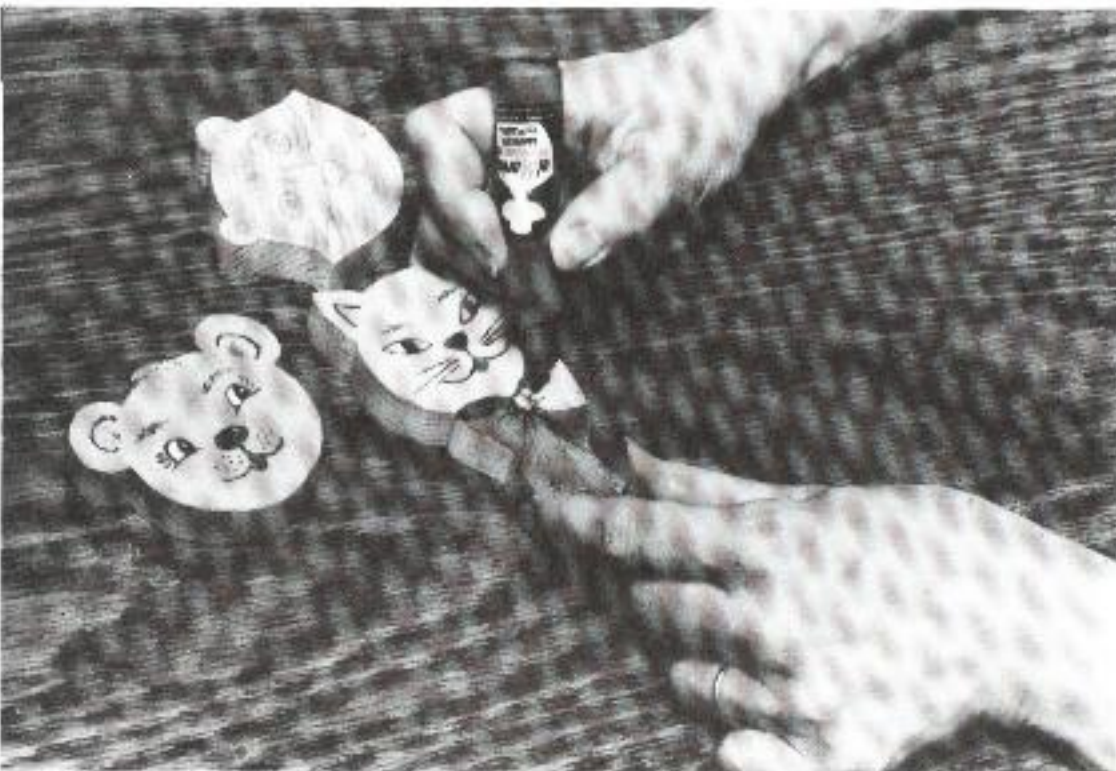

*Illus. 3. Soft-tip markers can be used to color areas outlined with a woodburning tool.*

Although the patterns are what we consider a useable size, we certainly encourage their modification in size or detailing to satisfy individual requirements. Some alternate ways to use the designs and patterns to enhance a specific project are as follows:

1. *Change sizes.* Enlarge or reduce patterns as you see fit. To copy and transfer patterns, do the following: Draw with a ruler small, uniformly sized squares all over transparent tissue paper. These squares should all be either  $\frac{1}{4}$  inch or  $\frac{1}{2}$  inch in size. The greater the detail and the smaller the design being copied, the

smaller the squares should be drawn. Next, on a large piece of paper, about the size that you want the eventual project design to be, divide the space up with exactly the same number of squares as occupied by the design under the transparent tissue paper. The size of the larger set of squares can also be determined by the enlargement ratio desired. If you want the design twice the size, then draw big squares twice the size of the smaller ones.

Now, copy the design square by square. Copy each point of the original pattern on to the graph squares. Curves may be

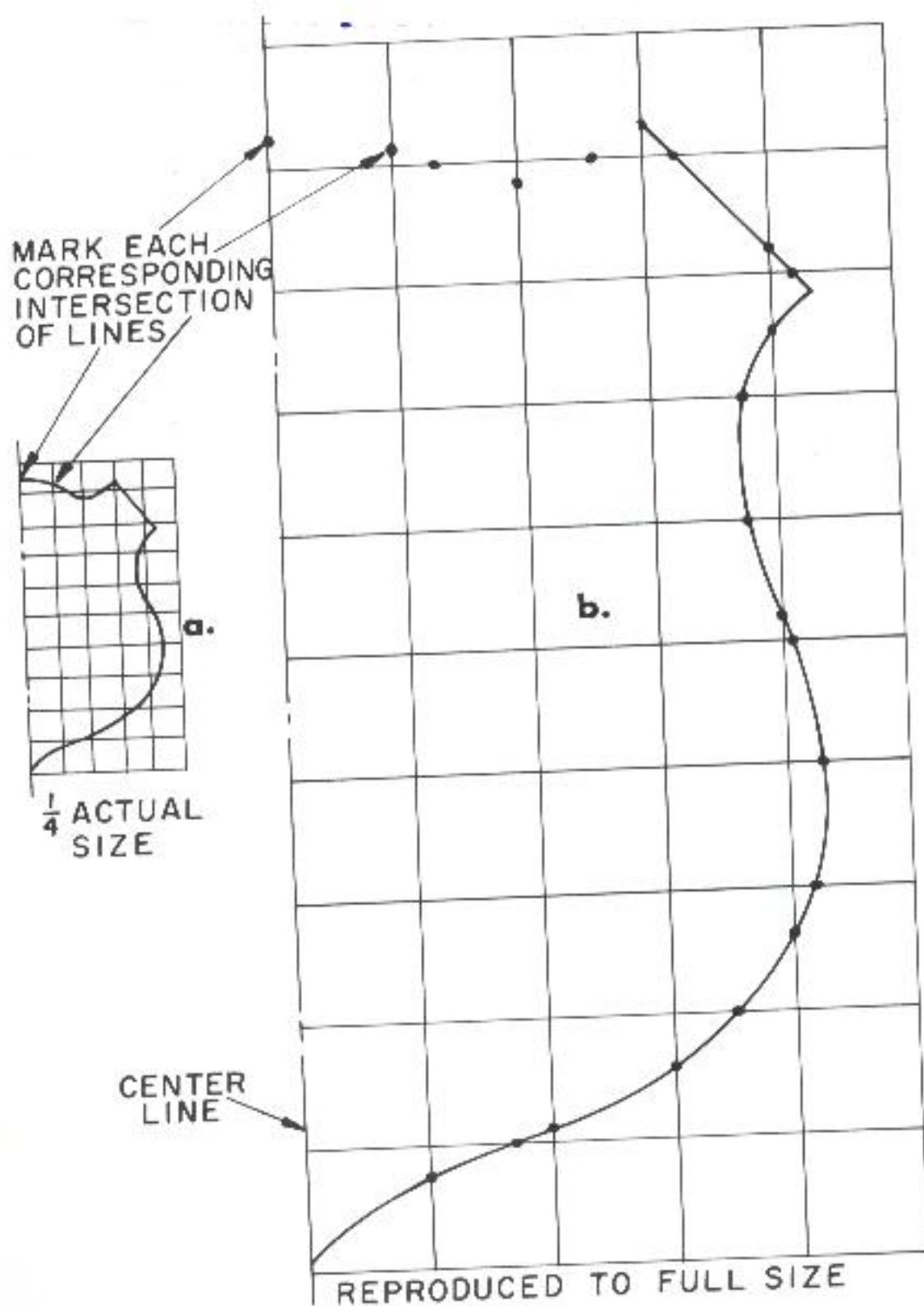

Illus. 4. Copying the design square by square.

drawn by "eye" after locating them with reference to their surrounding square. However, it is more accurate to mark the points where the line of the curve strikes each horizontal and vertical line, as shown in Illus. 4. The example shown has a 1 to 4 ratio, which means the design is enlarged four times larger than the original.

One final point. Some office copy machines have enlargement and reduction capabilities.

2. *Flop the design.* If a goose faces one way, just reverse it, or use two facing each other.

3. *Use the design in multiples.* For example, a row of pigs (connected or not) might be more interesting than just one, single pig.

4. *Crop the design.* Use only a part of it. For example, using just the head of a dog from a pattern might be more appropriate for your needs than a full-bodied pattern.

5. *Change the intended purpose.* Instead of using a pig puzzle design, for example, as a puzzle, drill holes in the back to convert it into a crayon holder or just drill a single hole to make it into a country candle holder.

6. *Paint some, stain some, do not put a*

*finish on some projects.* Different finishes and colors applied to the same project suggest variety, which is important if you are selling your scroll-saw cutouts.

If you are new to scroll sawing or you anticipate buying a scroll saw, we recommend our companion book, the *Scroll Saw Handbook*, also published by Sterling Publishing Co. It contains all of the necessary information on using scroll saws, including descriptions and illustrations of the major kinds of scroll saws and explorations of the special features and limitations of the various machines. Also included are chapters on blade selection, basic sawing skills, bevel sawing, inlay work, compound sawing, marquetry, and many more areas of scroll-saw use. The advice, ideas, and tips presented in the *Scroll Saw Handbook* will help turn you into a skilled scroll-saw operator.

We hope that this book, the *Scroll Saw Pattern Book*, will provide you with many enjoyable hours of making scroll-saw projects, and that you will find enough ideas to keep you always looking forward to the next, new project.

Patrick and Patricia Spielman

# Country Cutouts

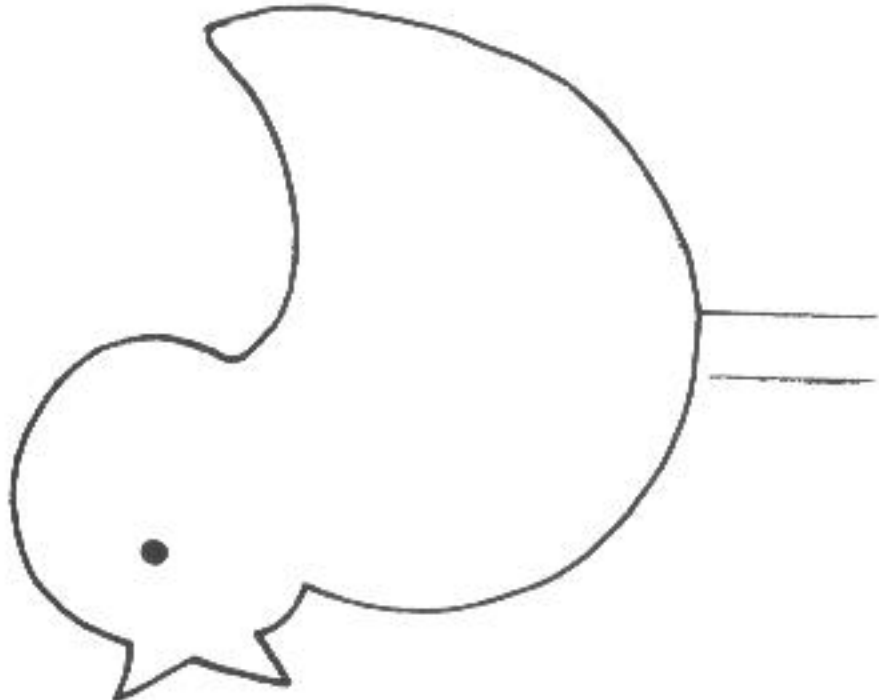
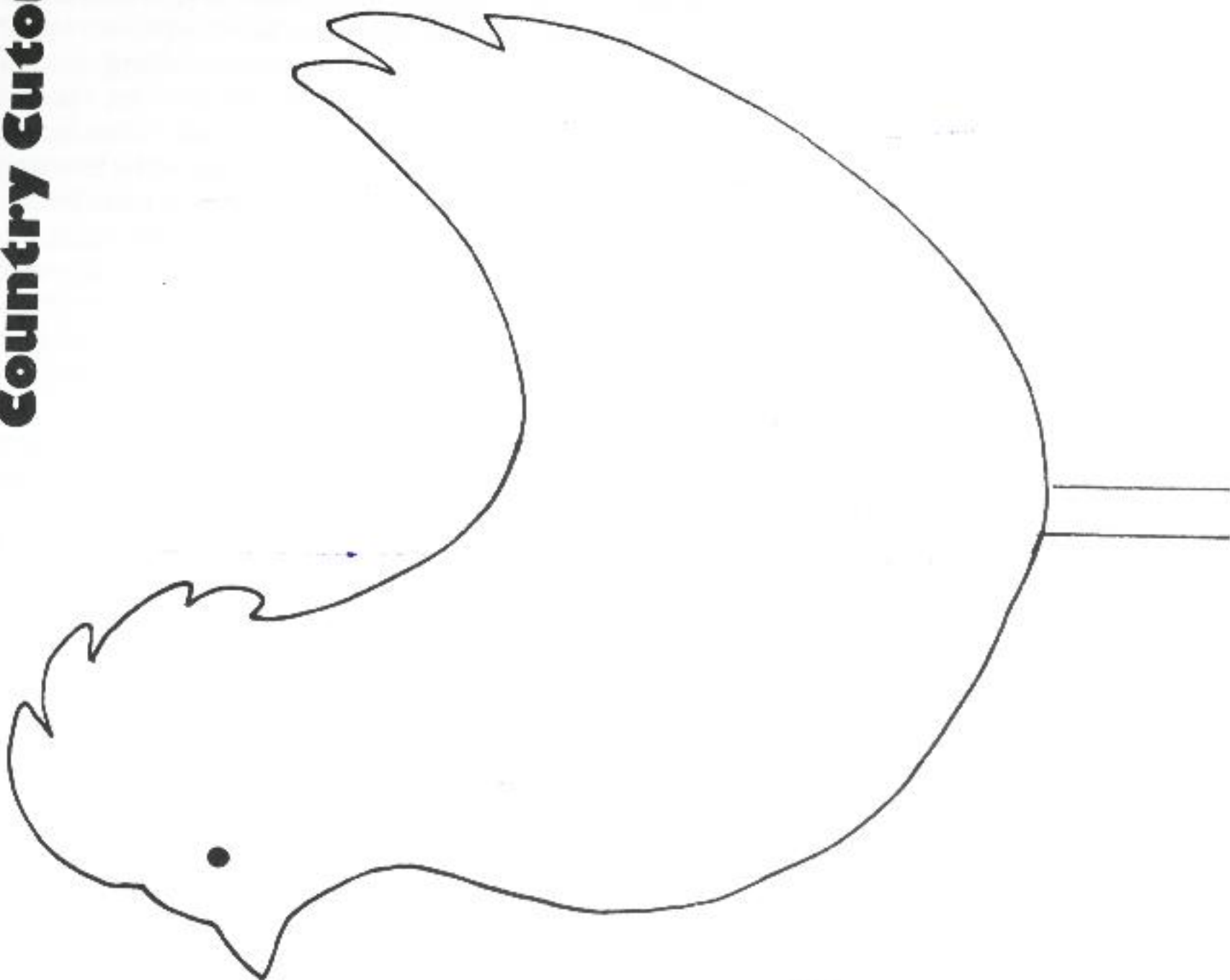

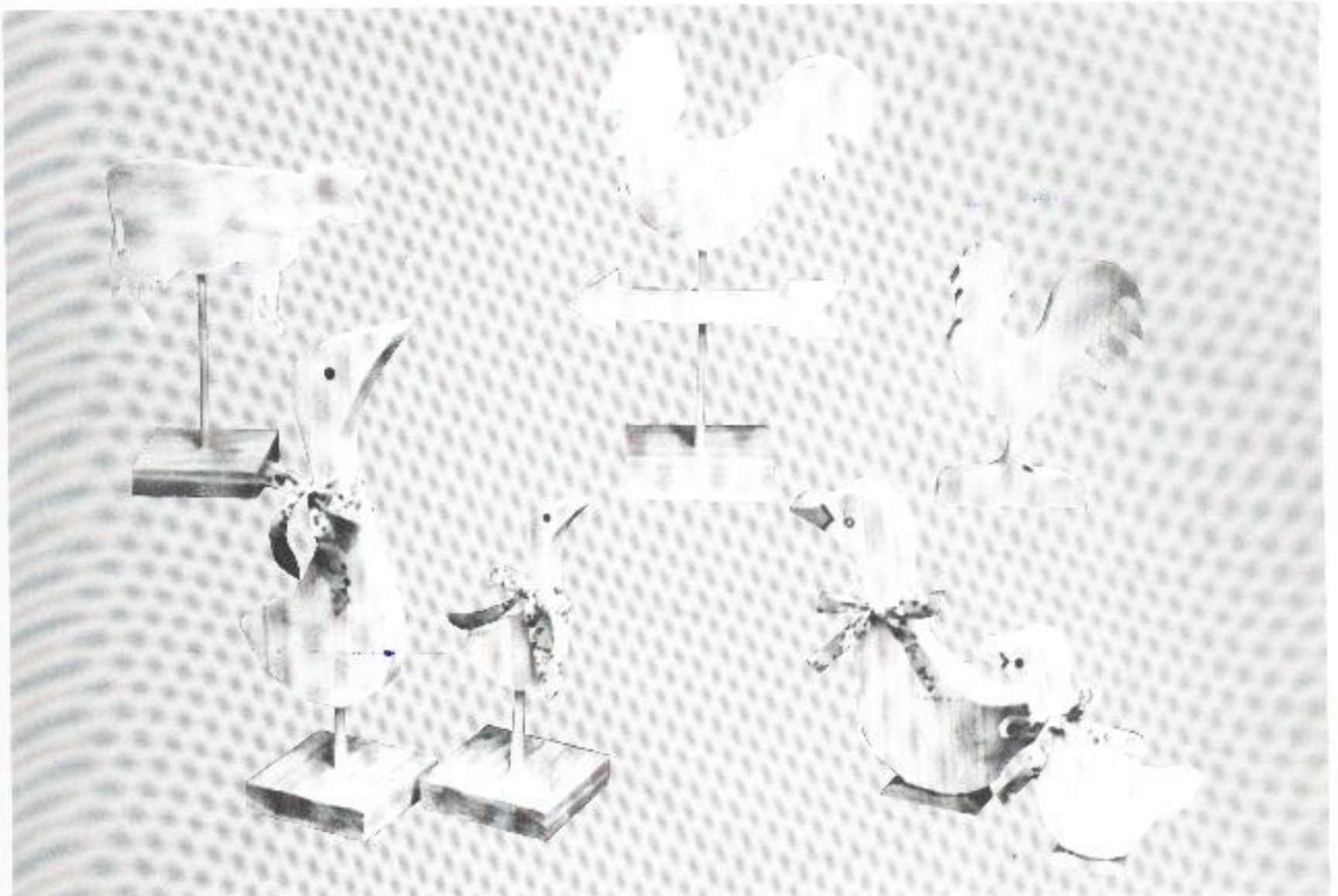

*Country cutouts (above and below).*

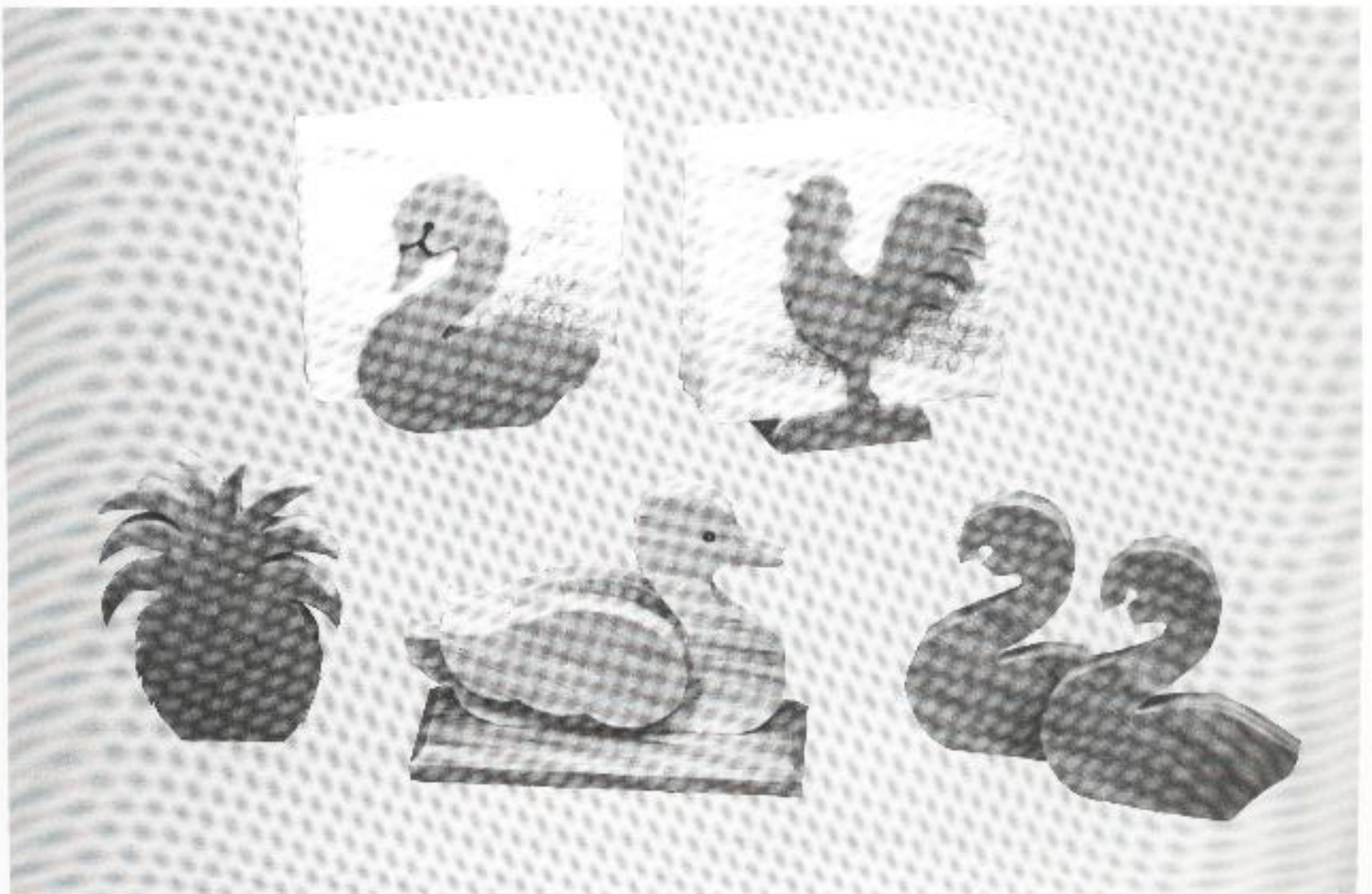

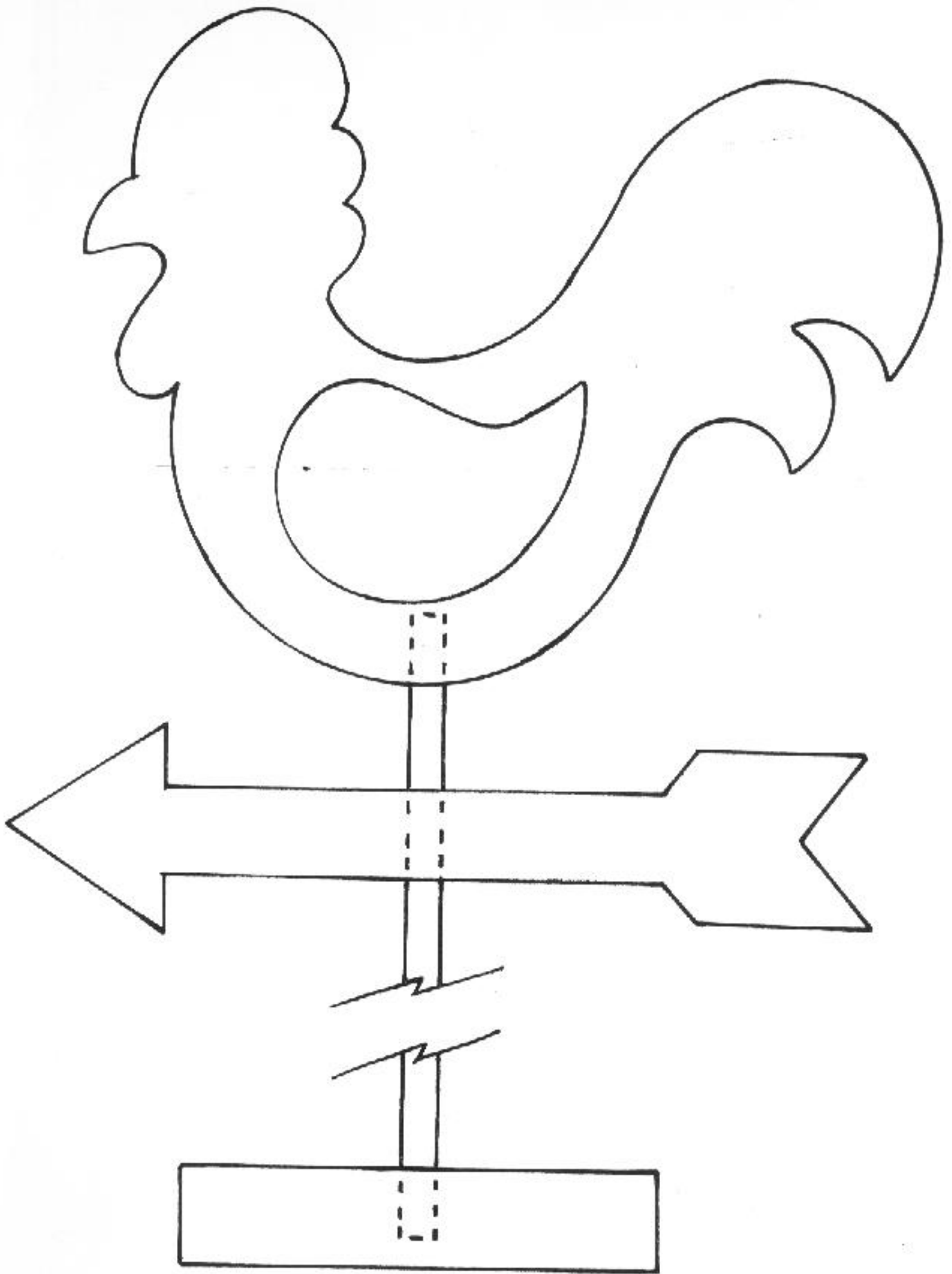

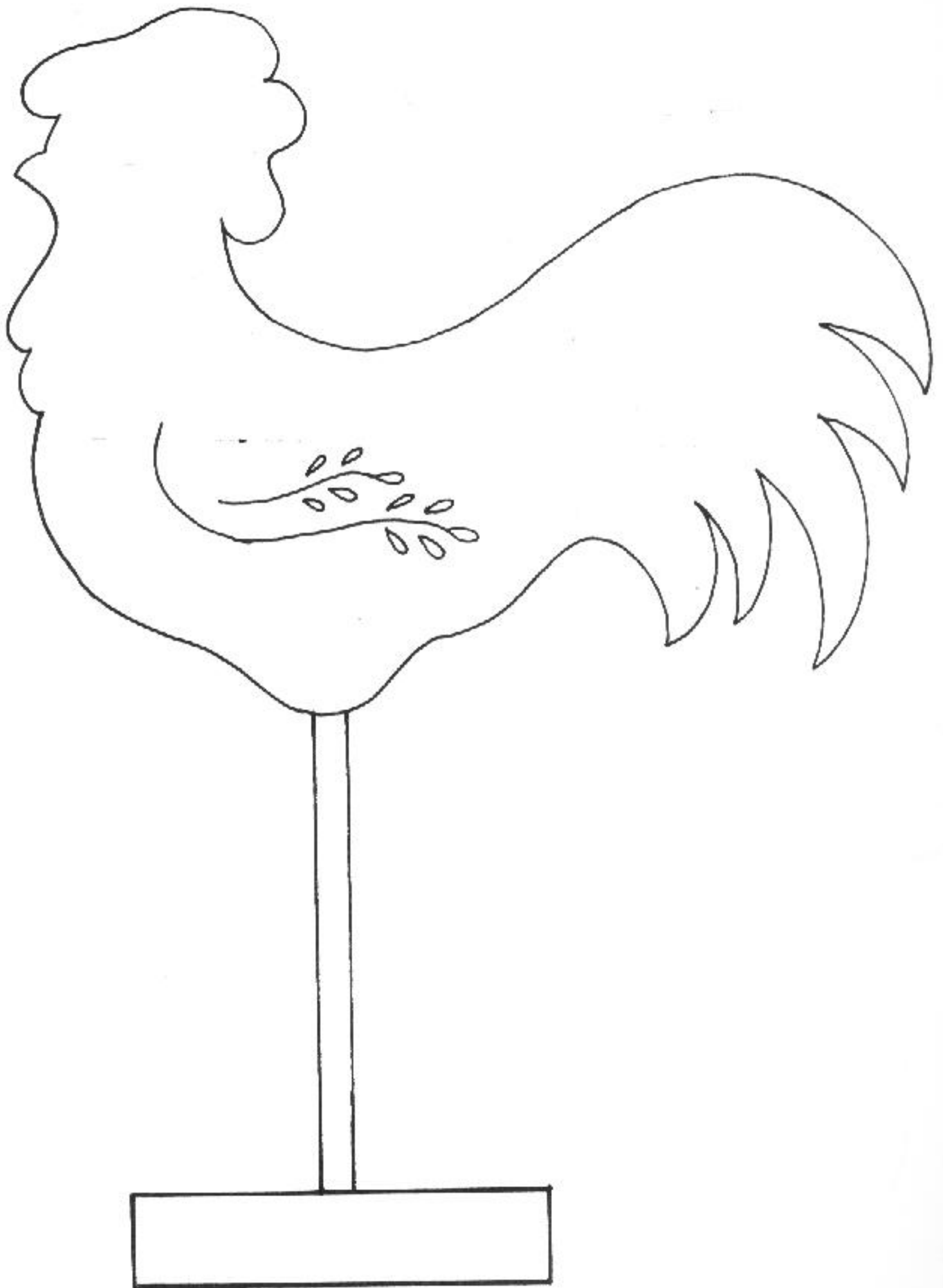

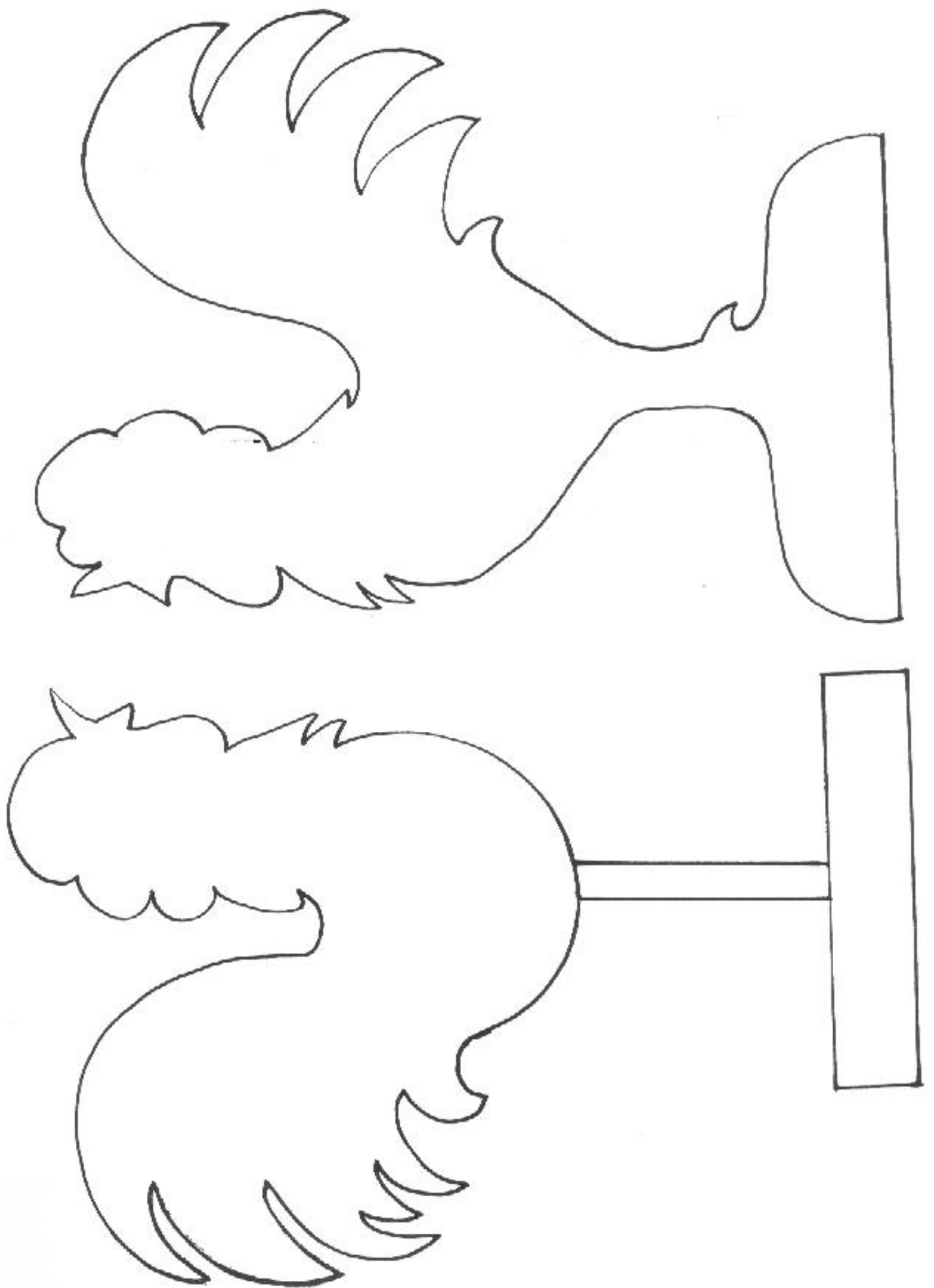



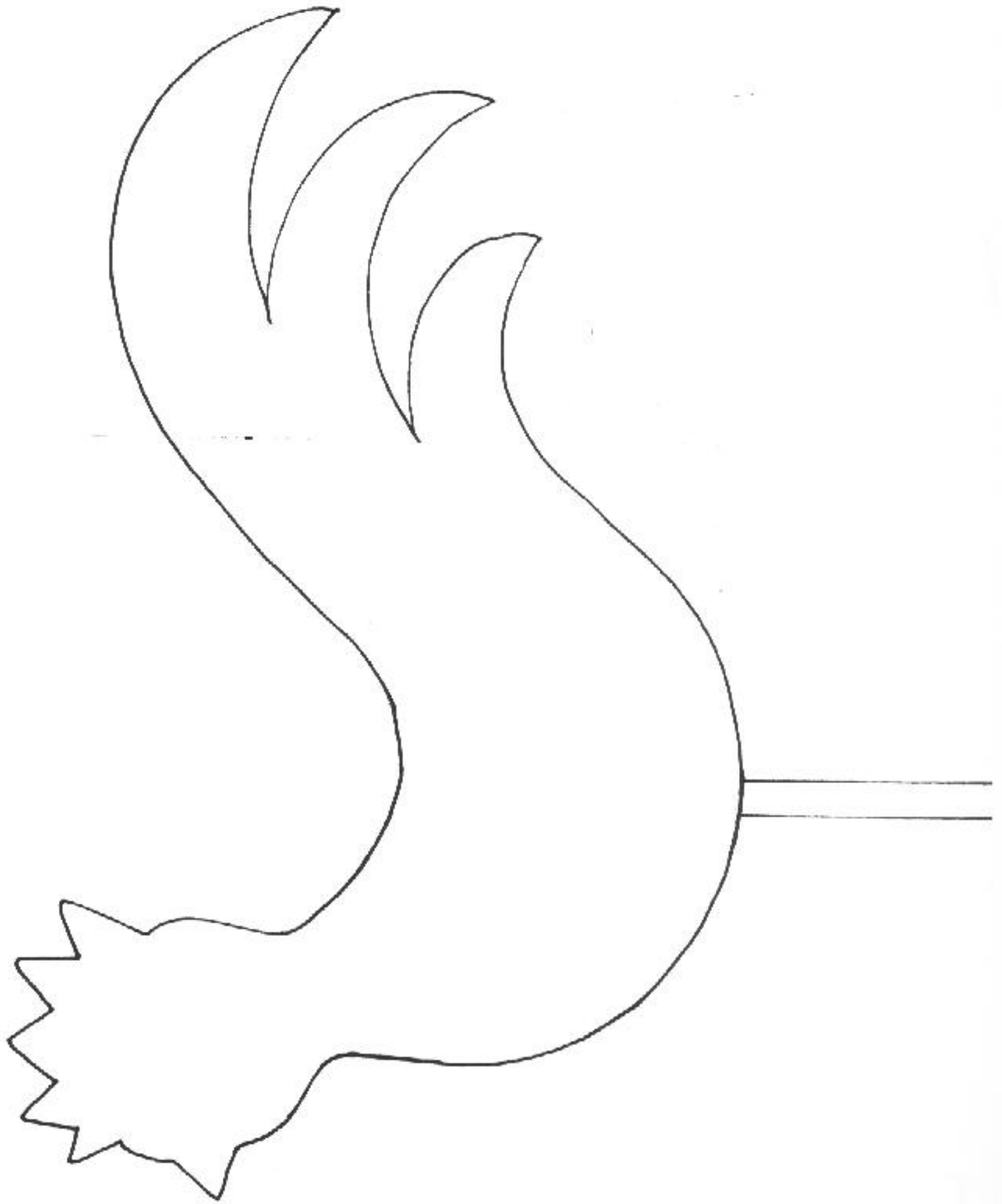

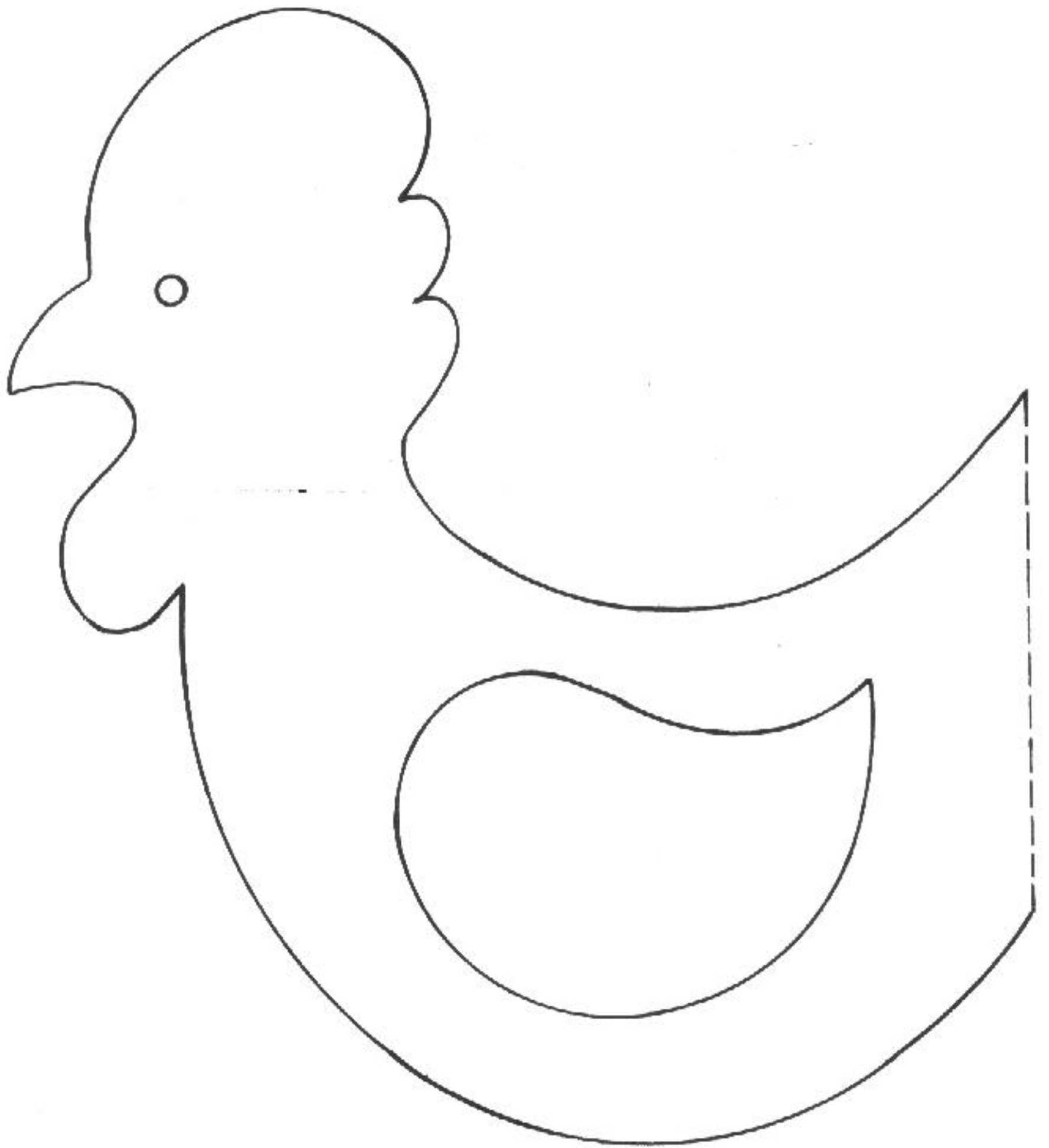

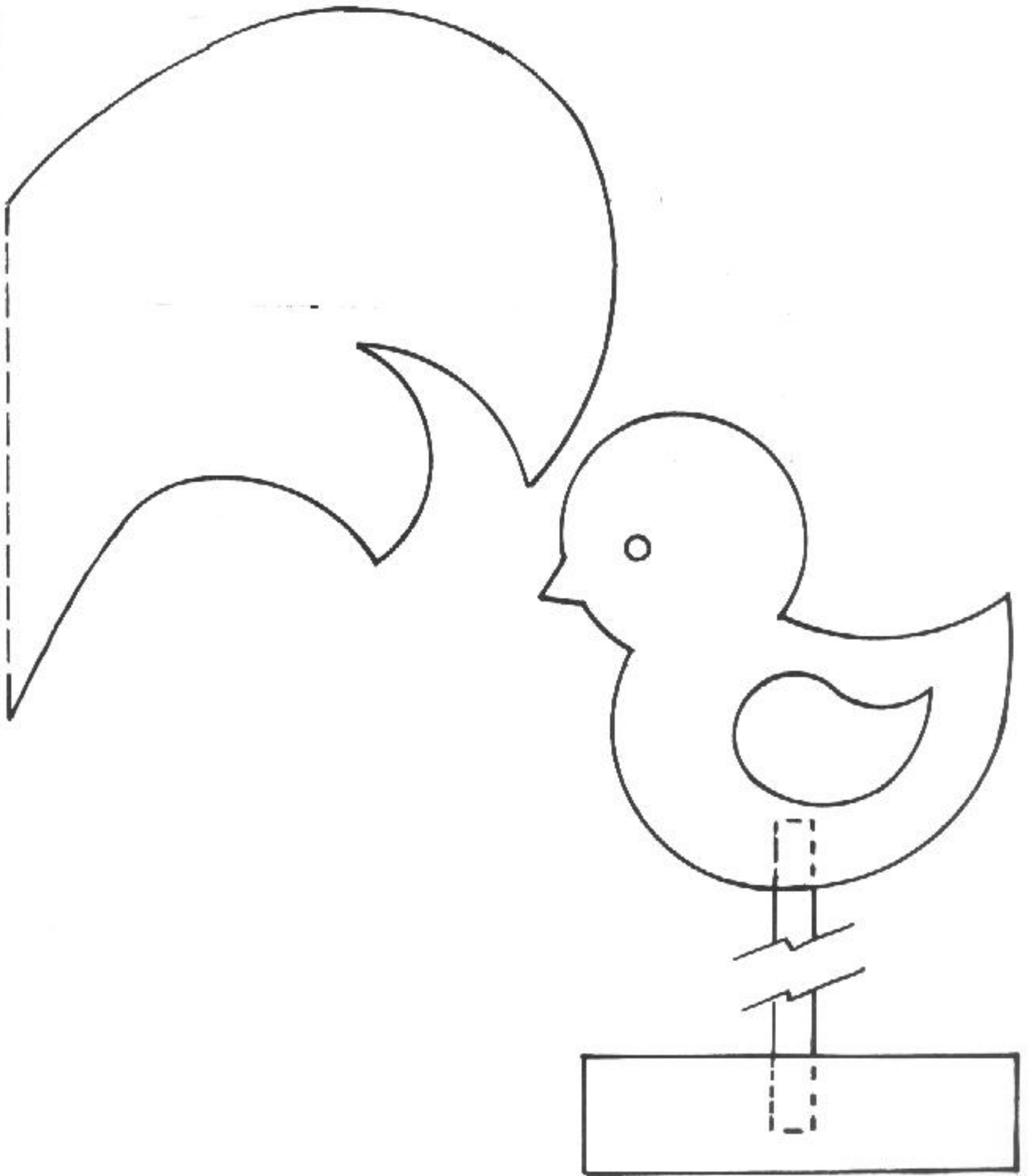

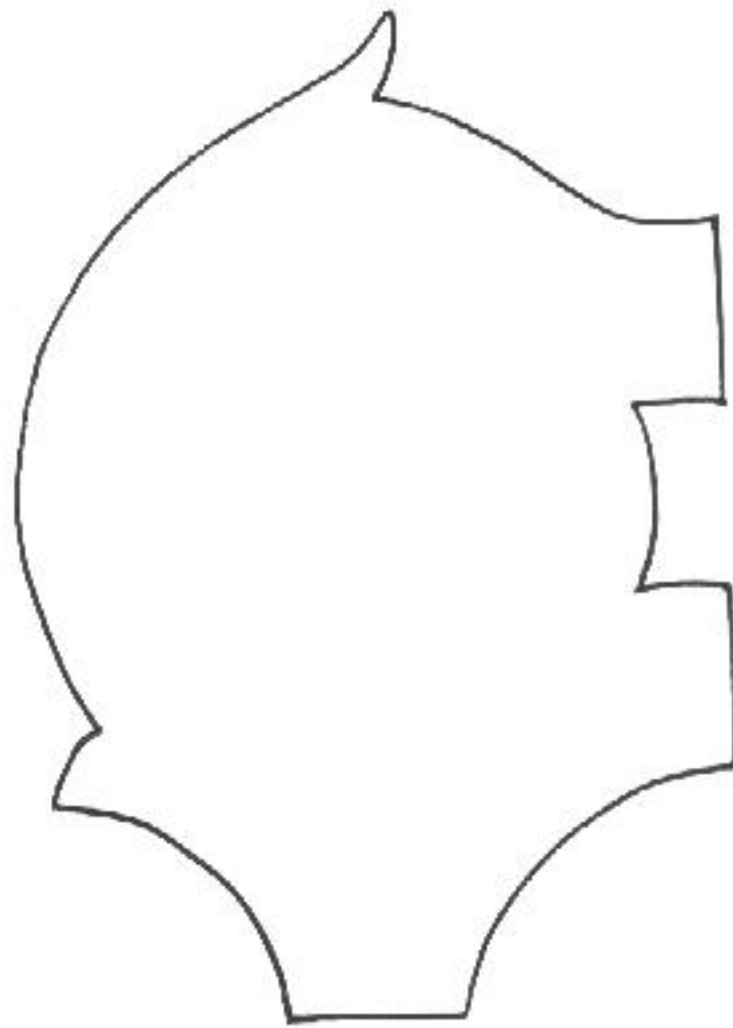
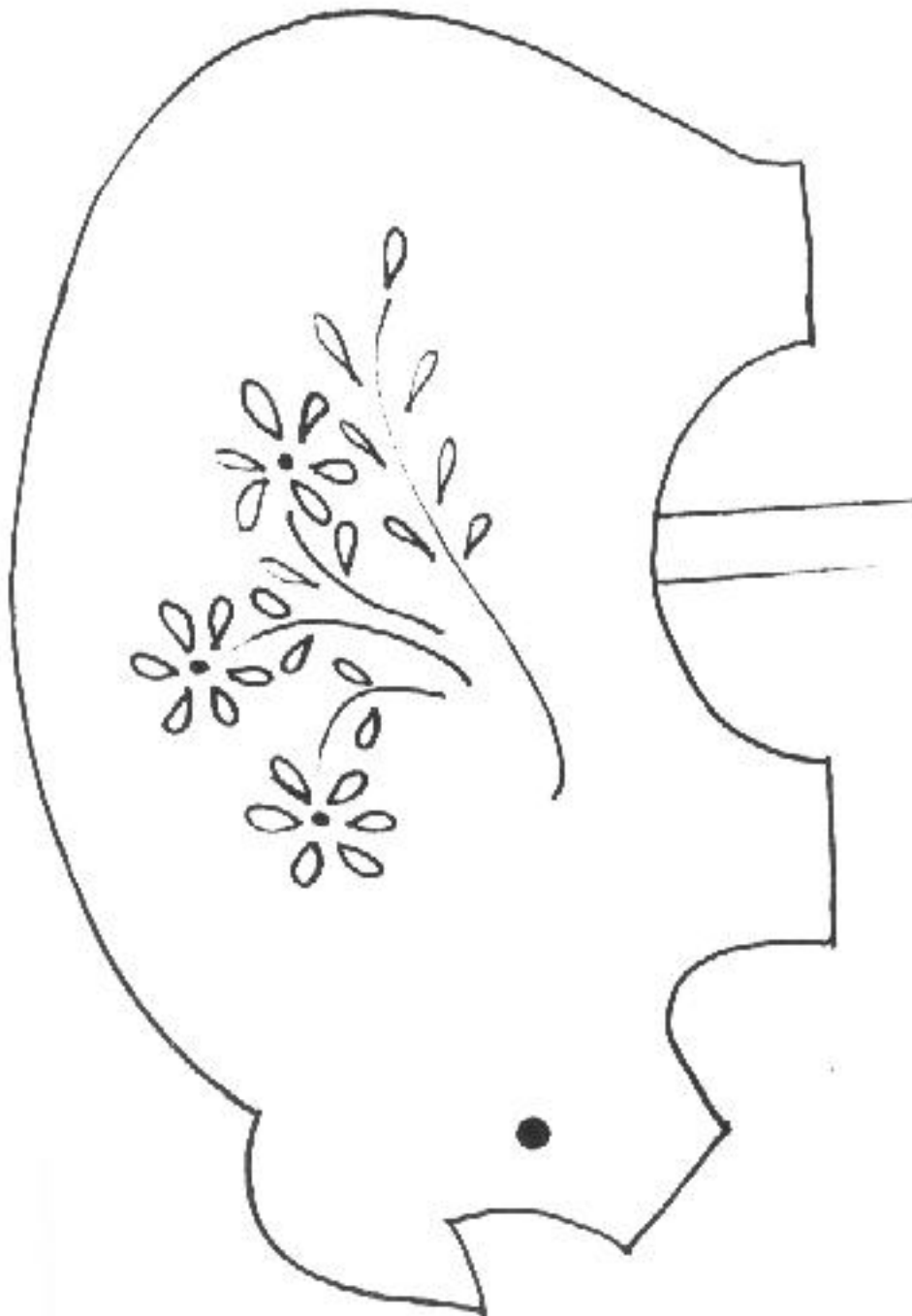
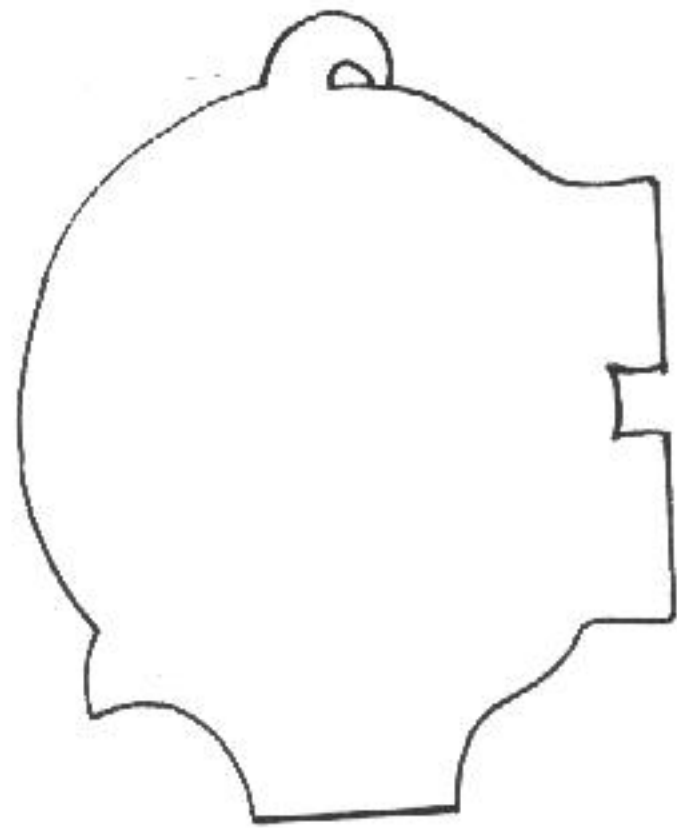
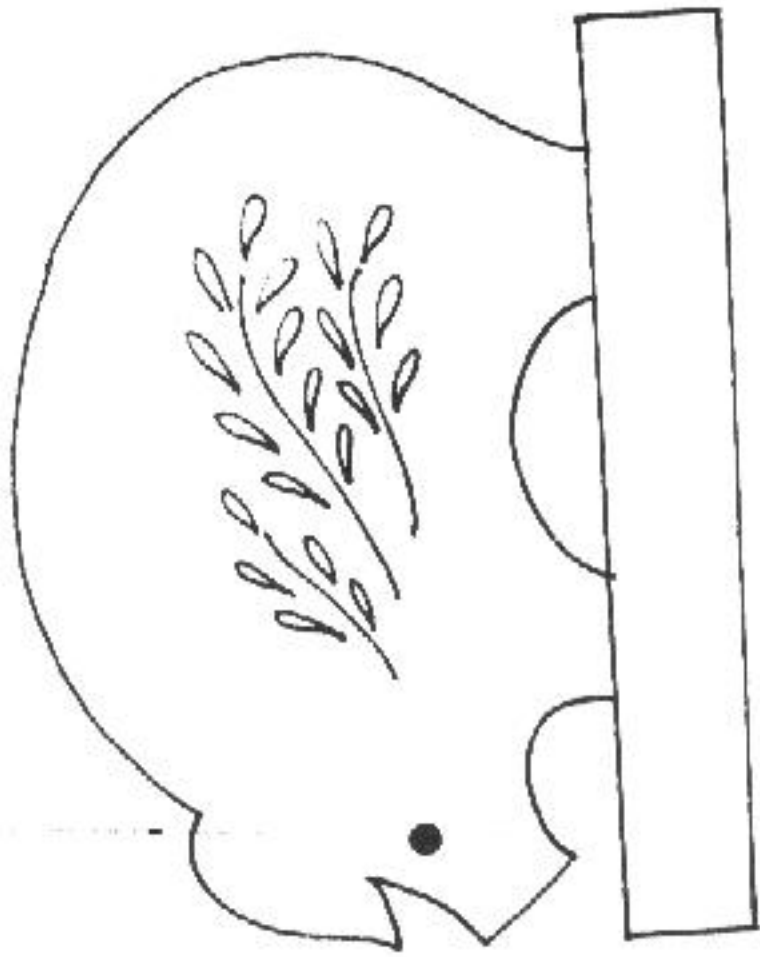

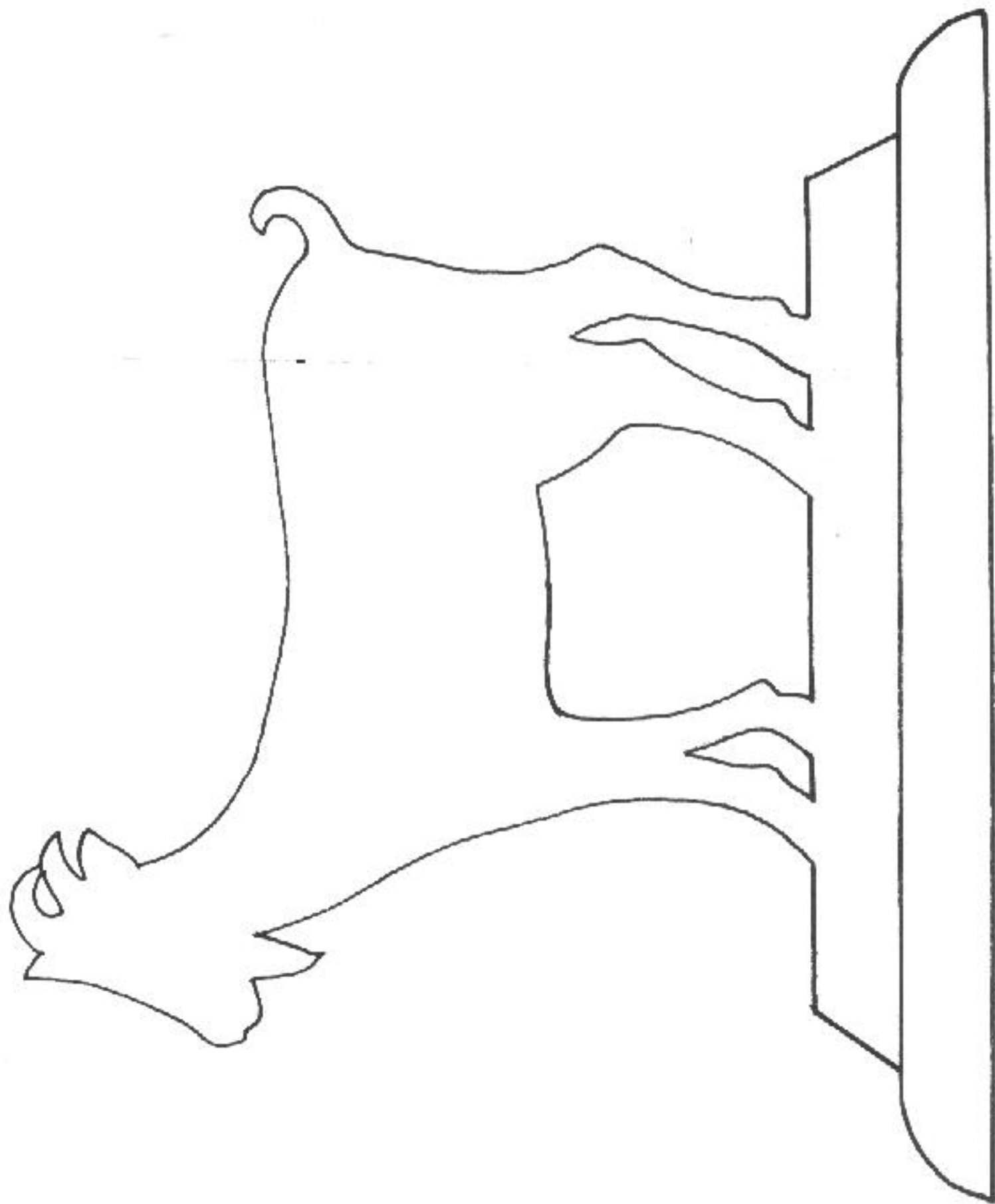

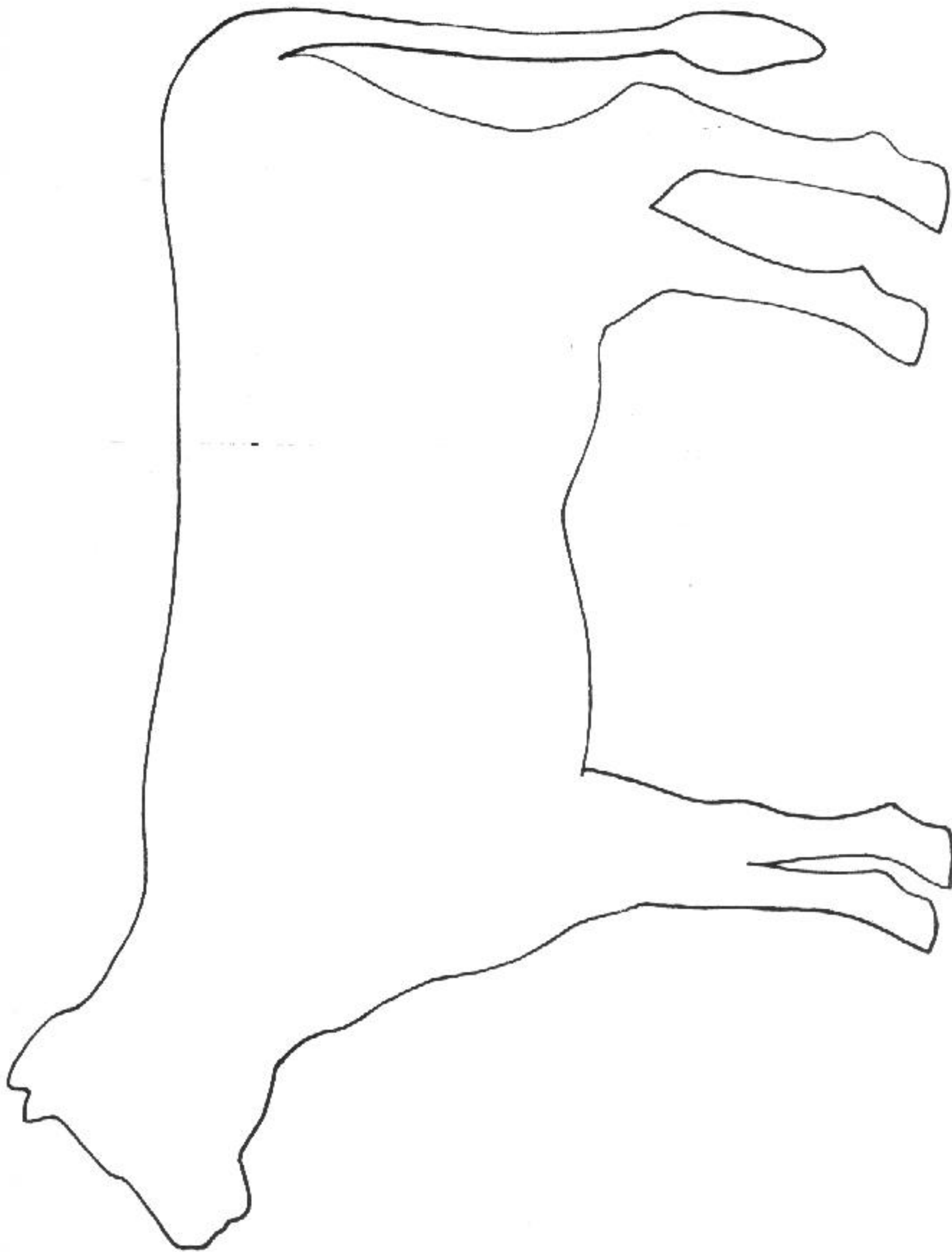

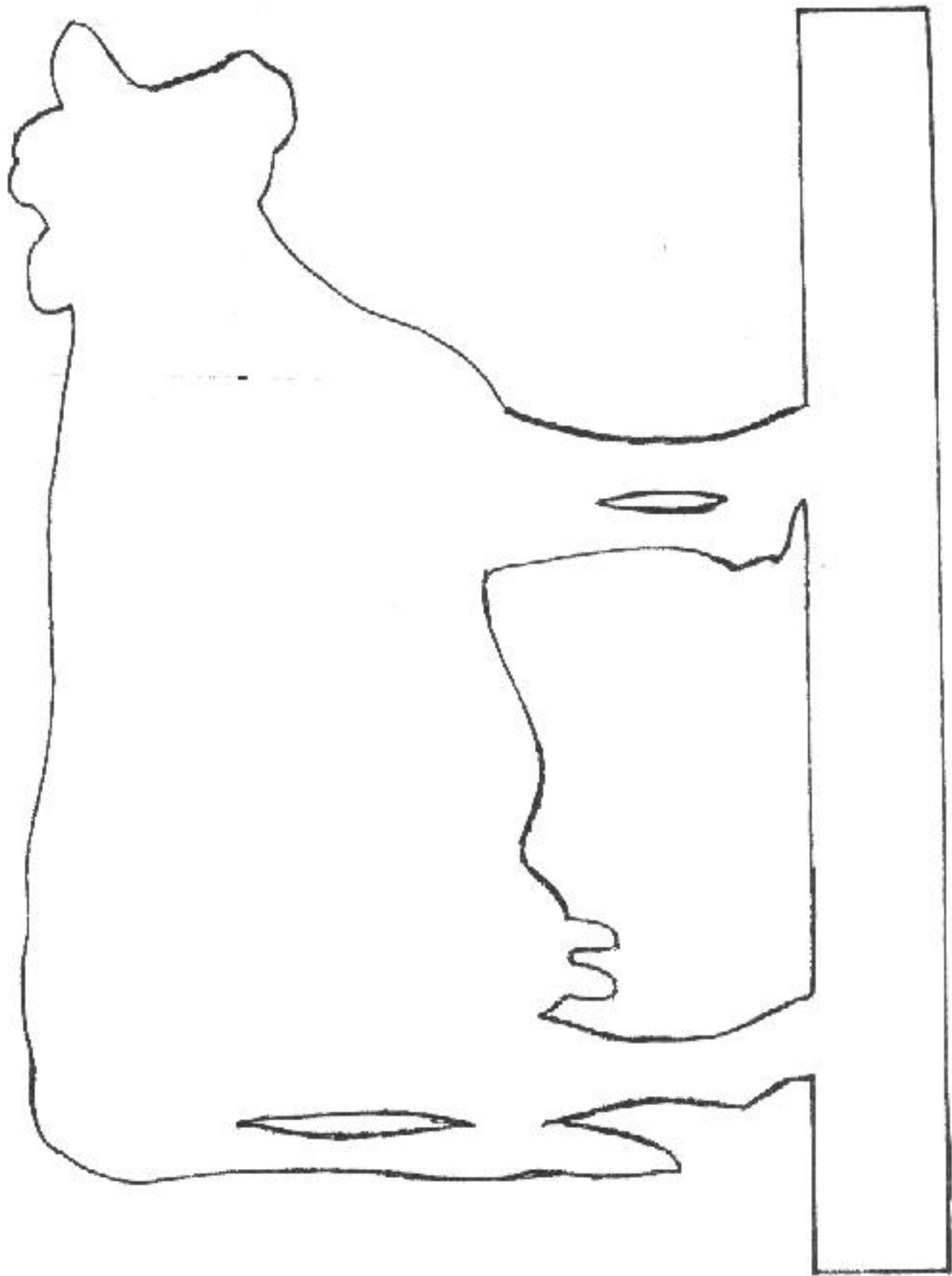

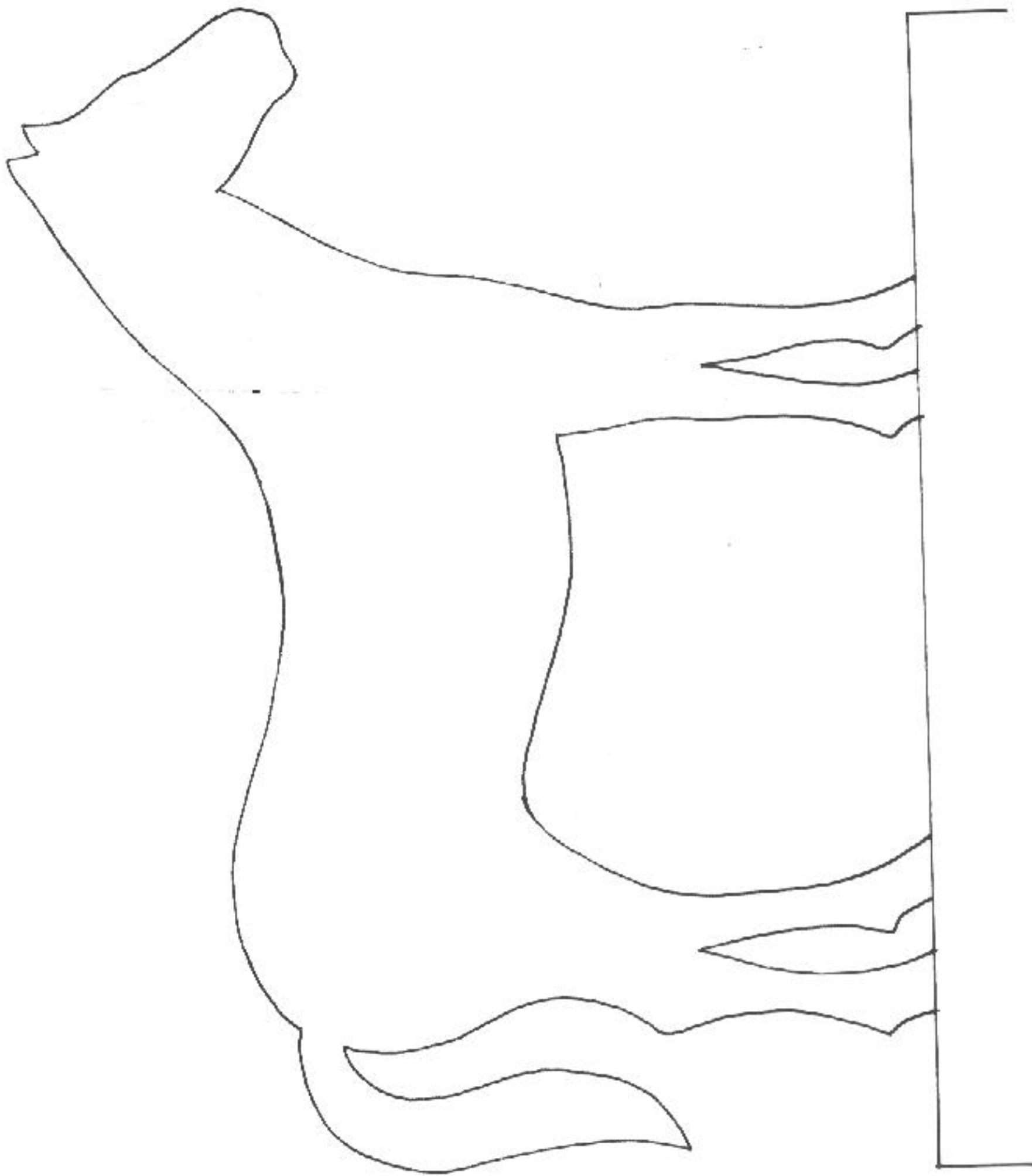



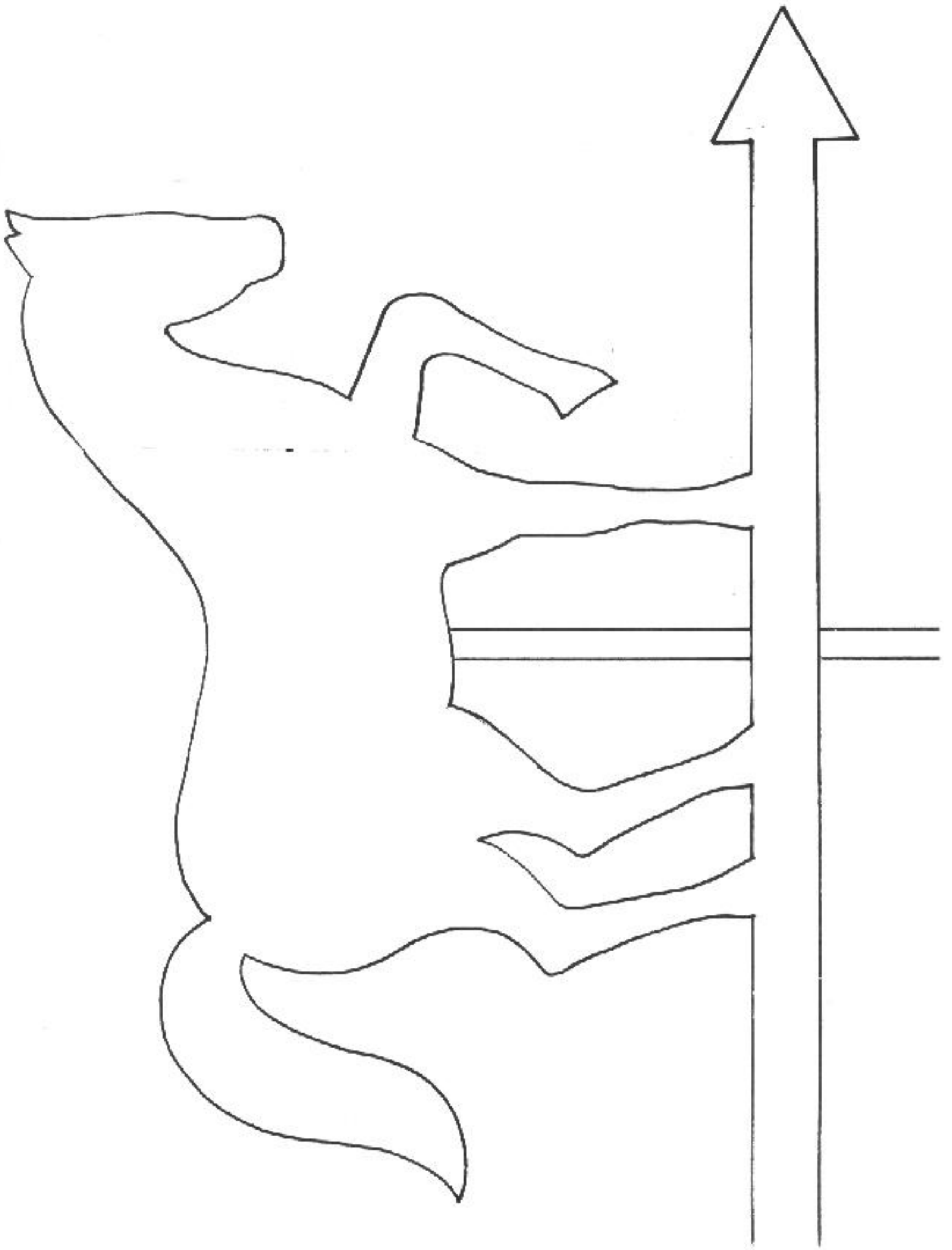

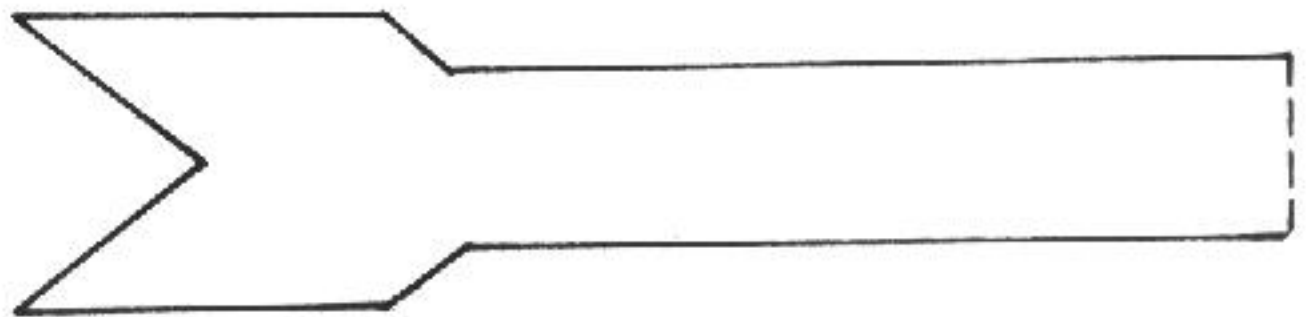
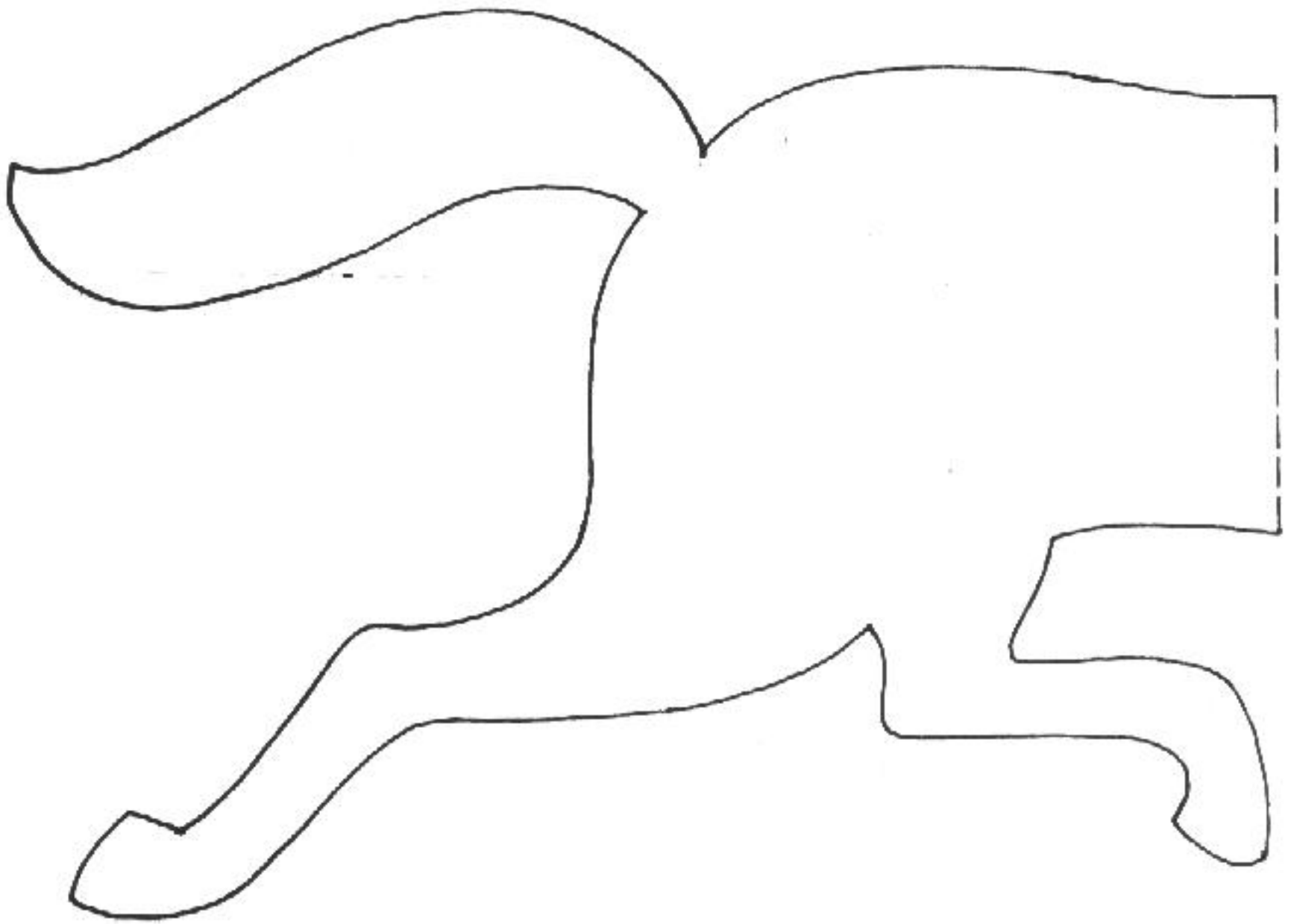

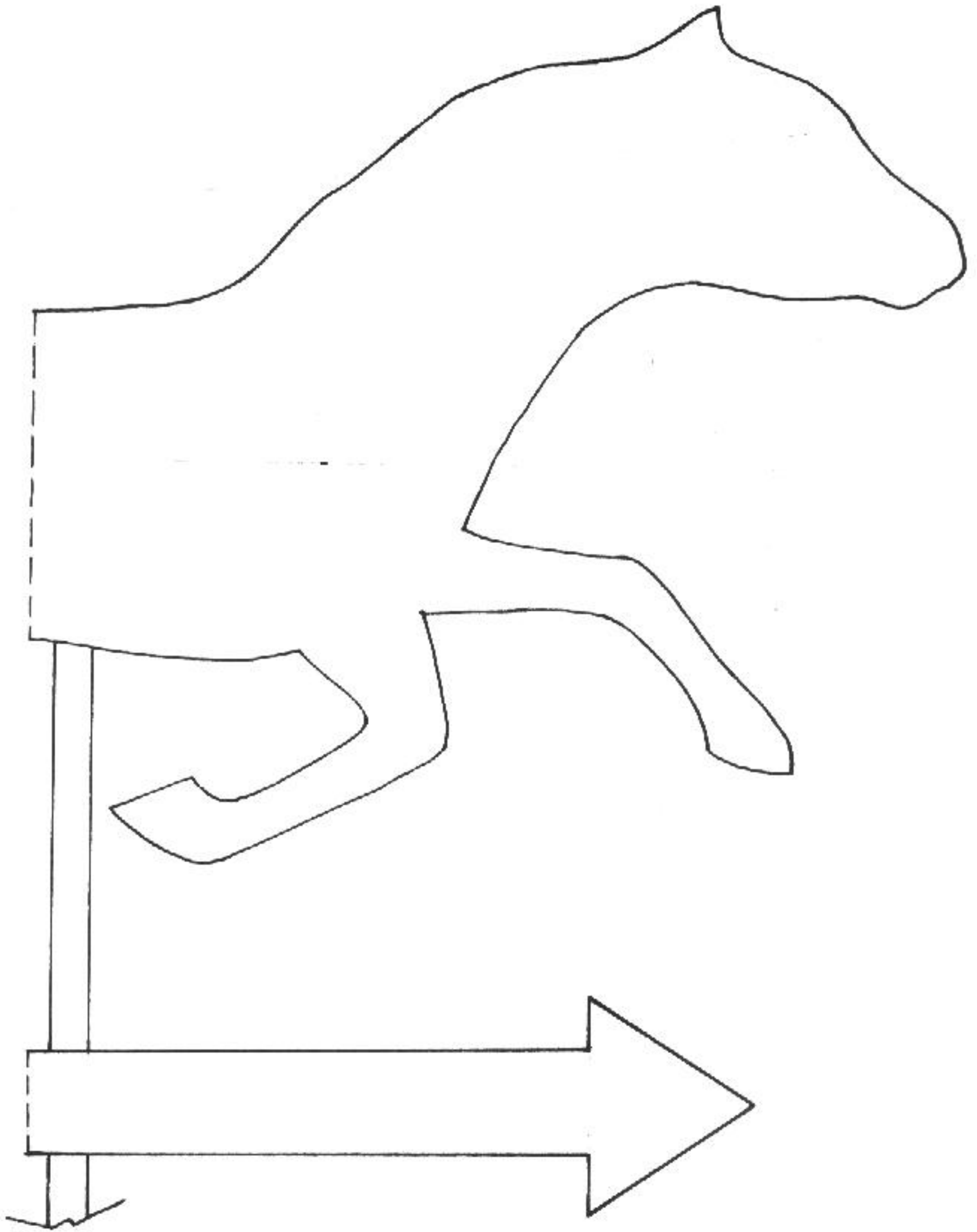

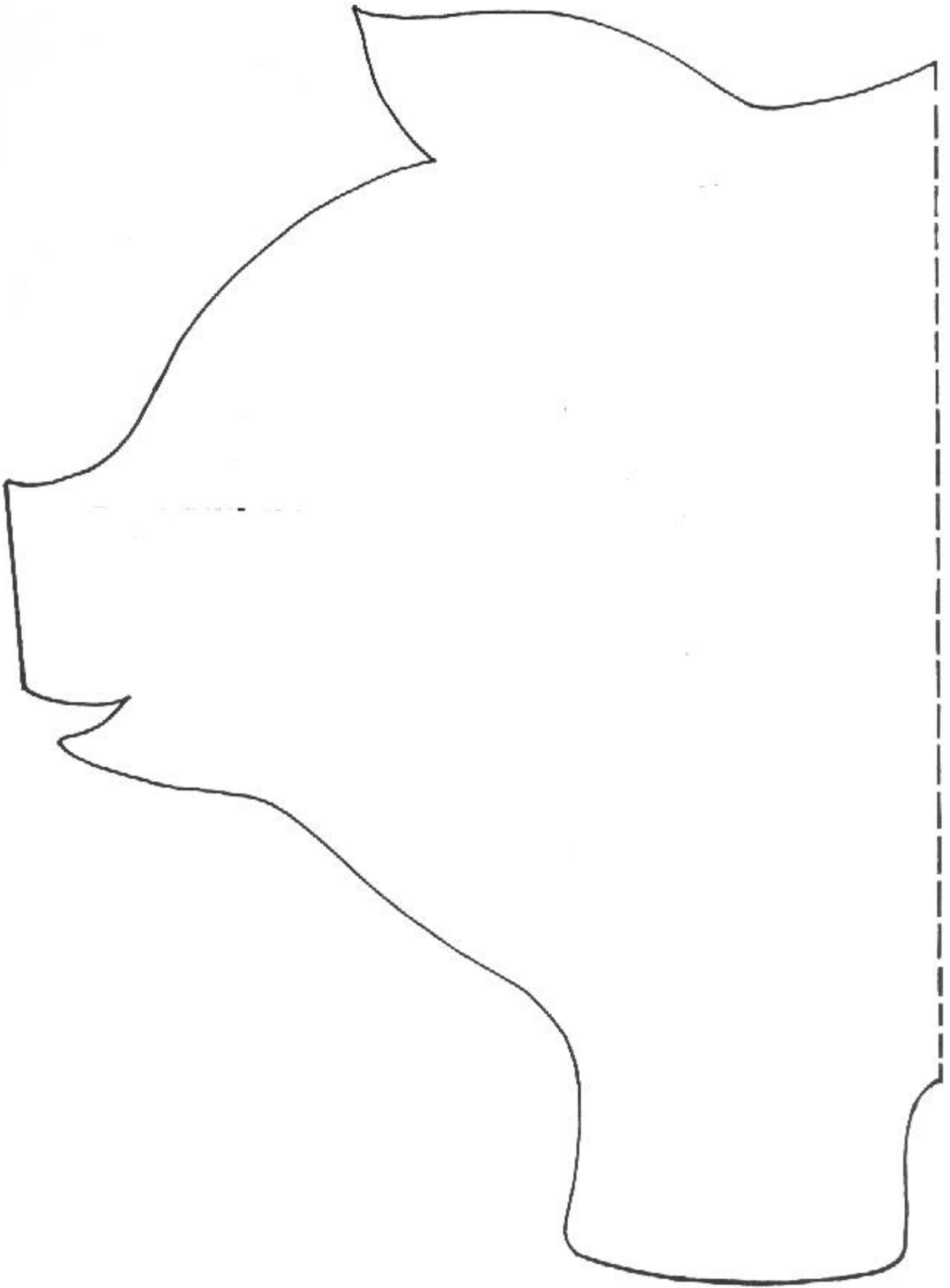

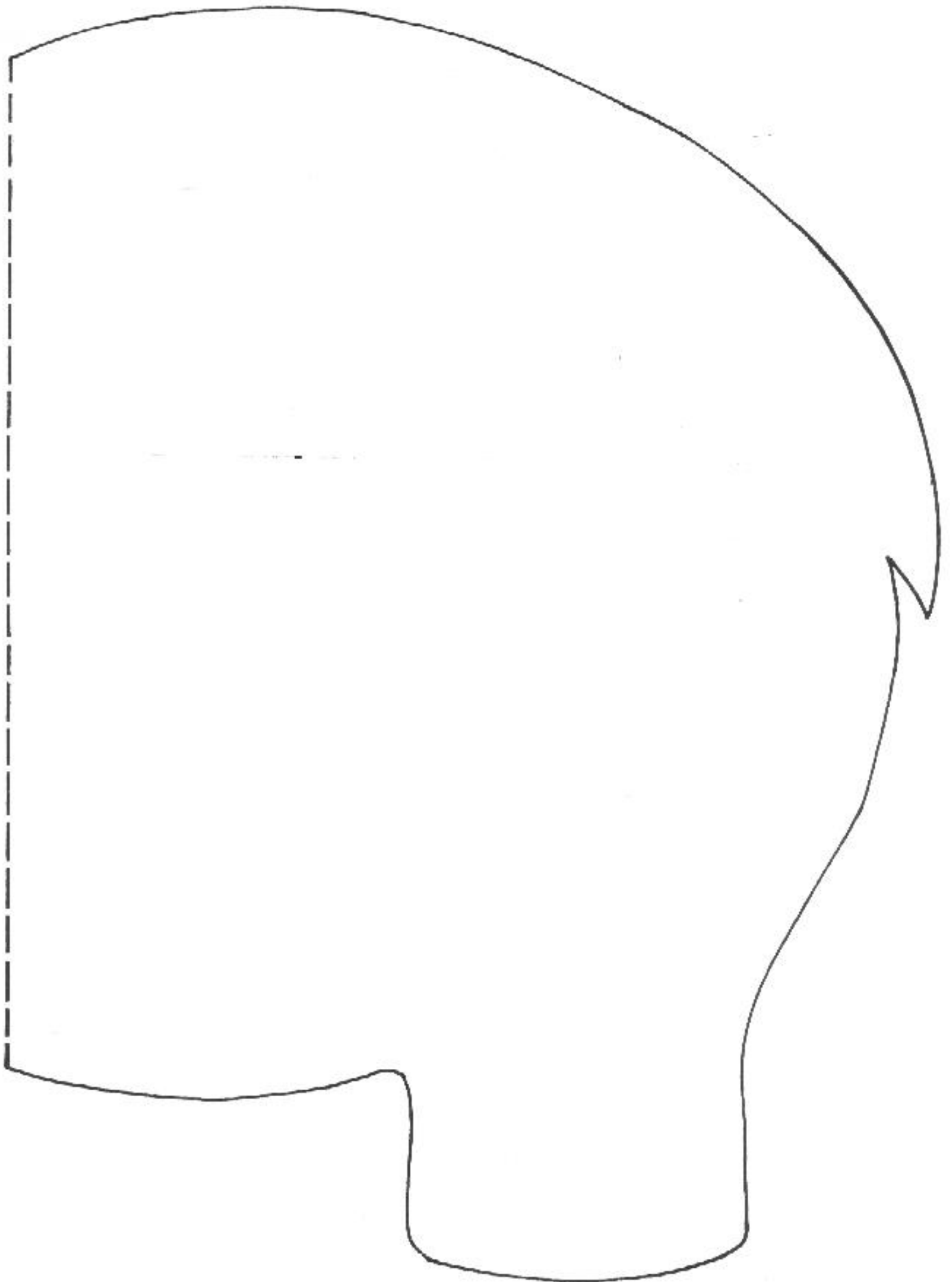

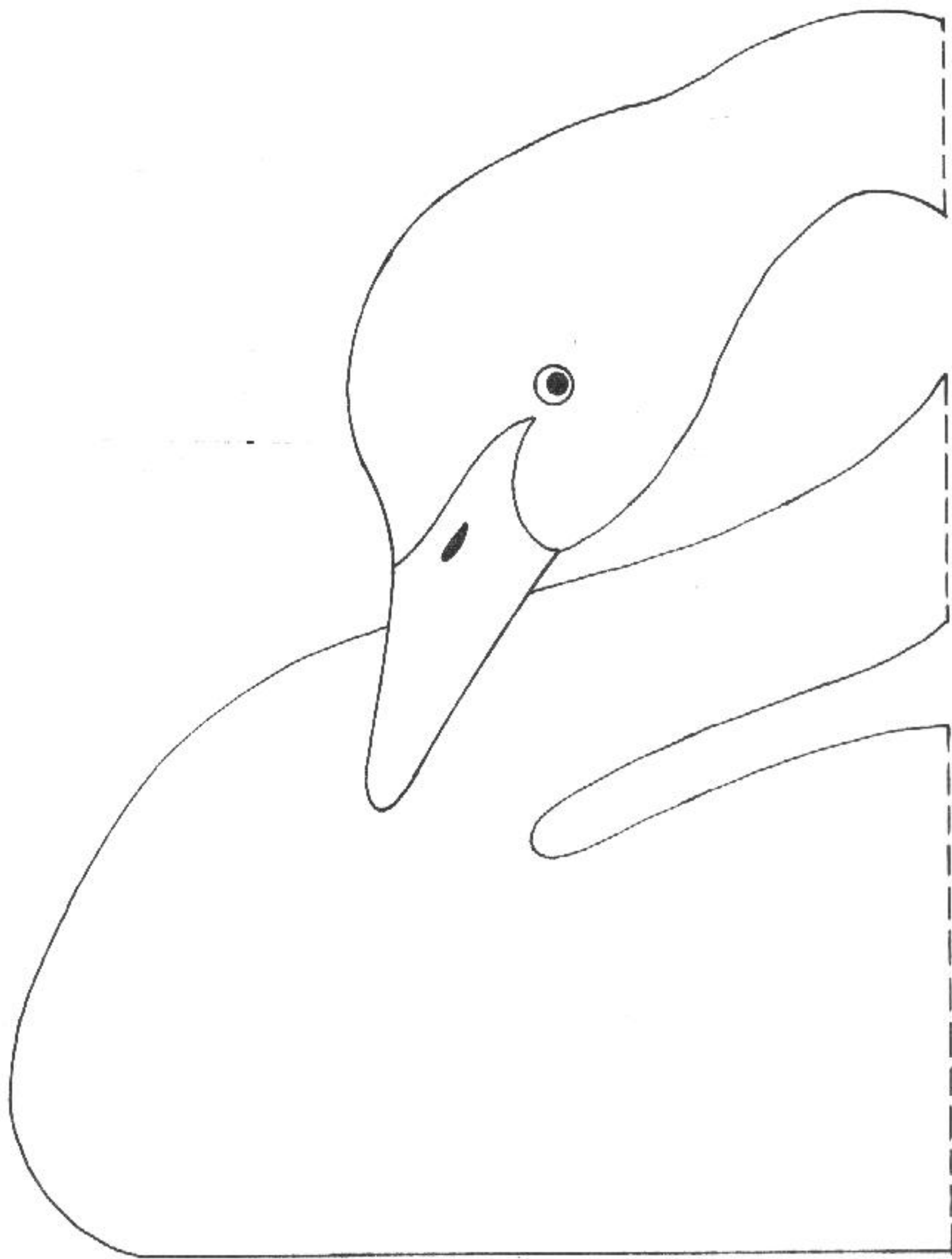

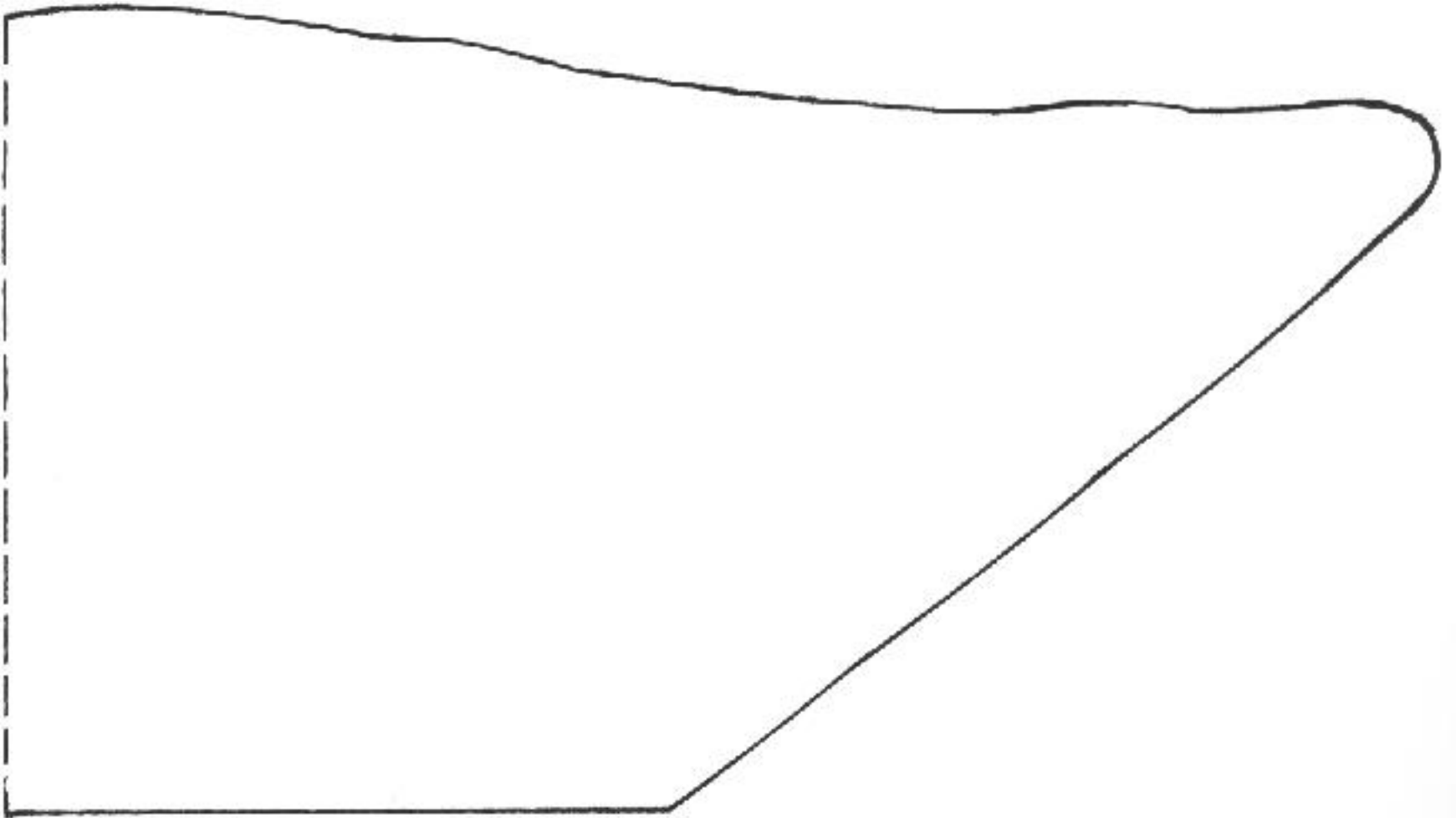
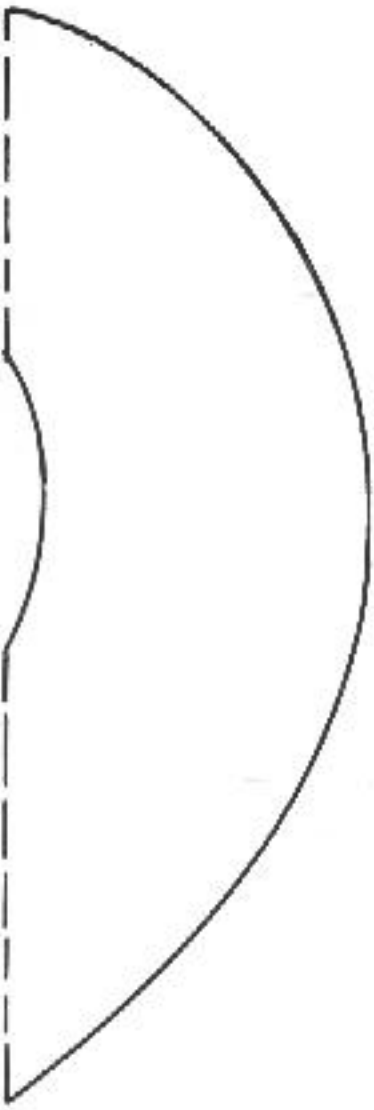

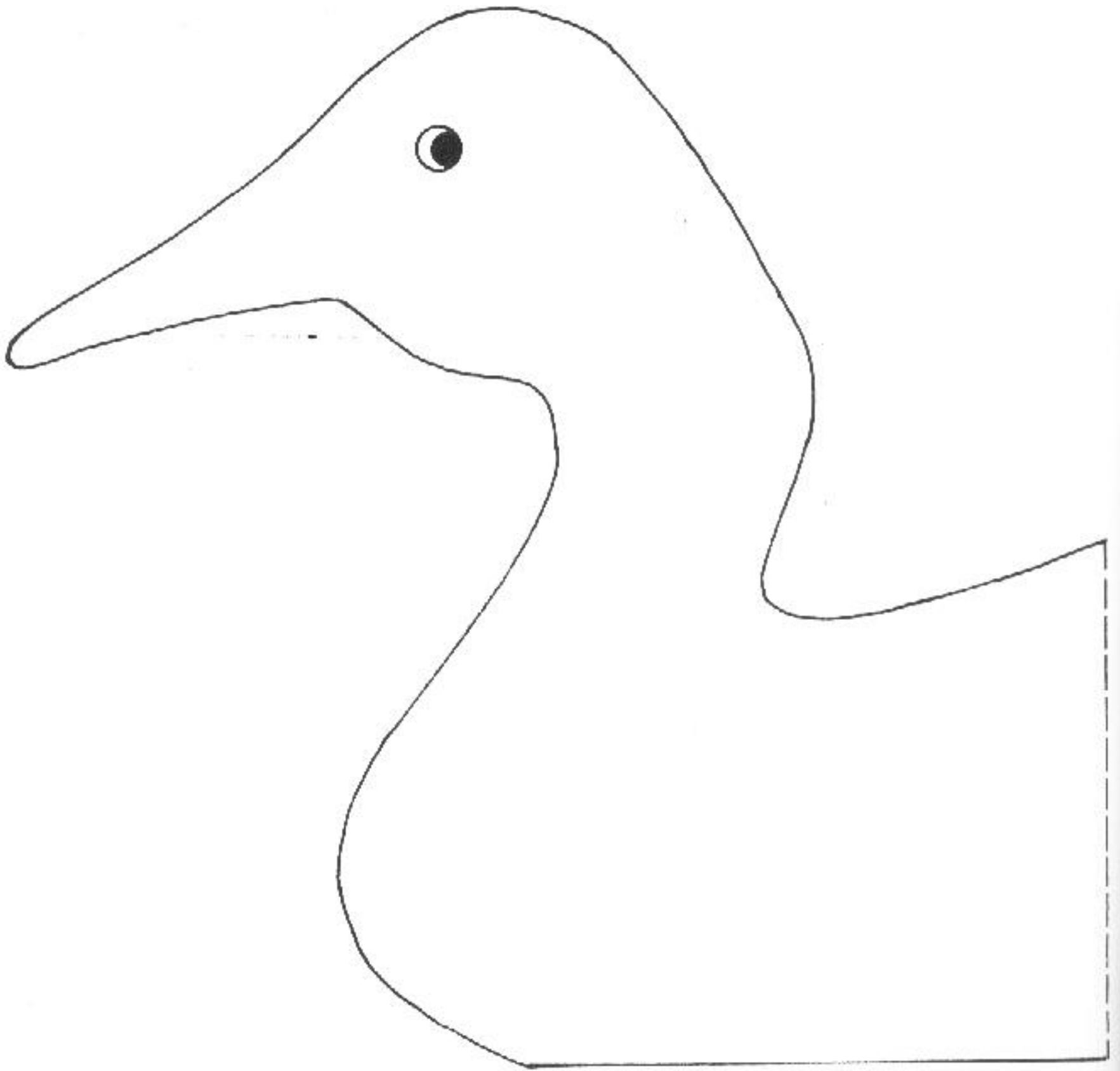



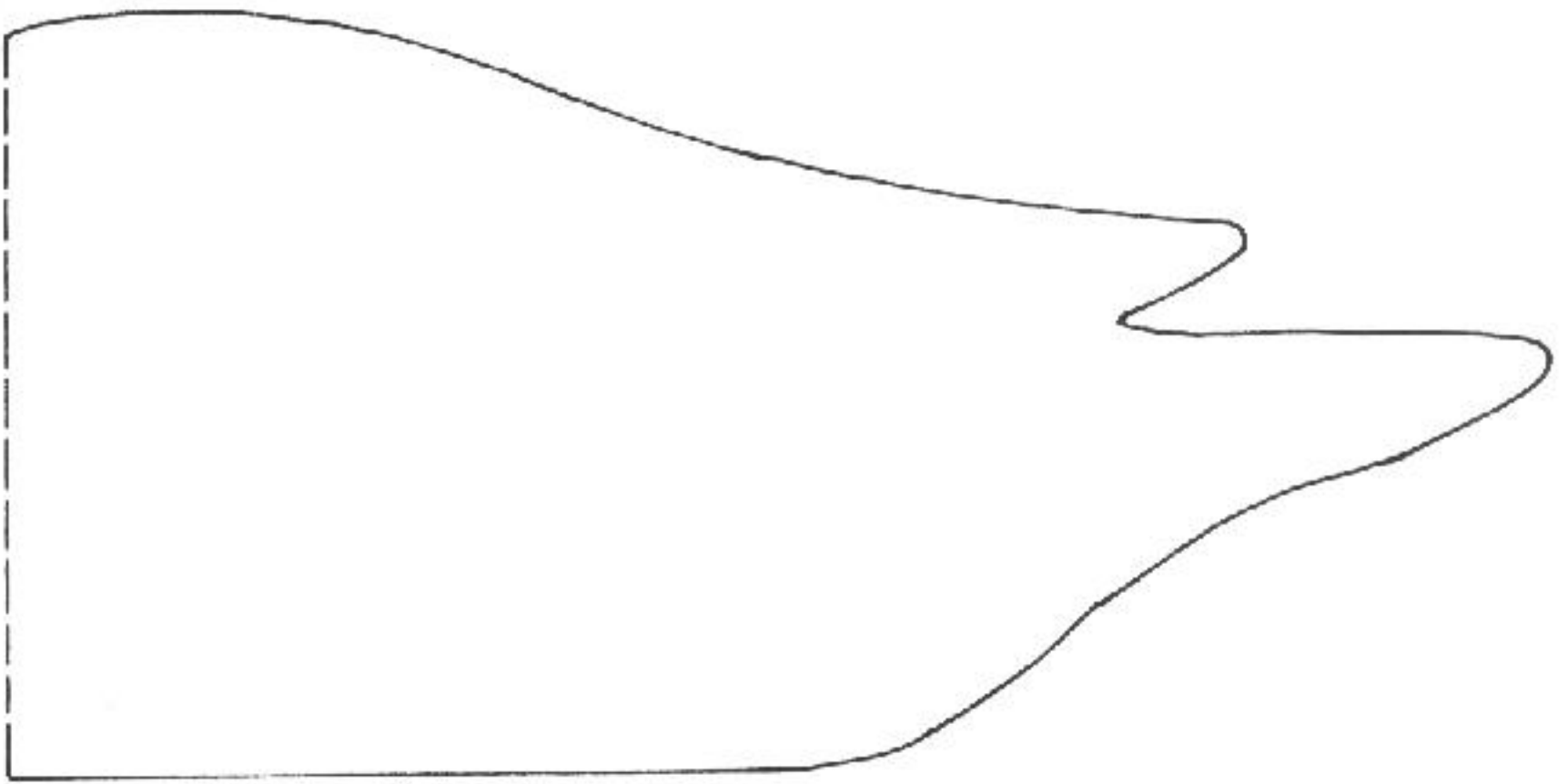

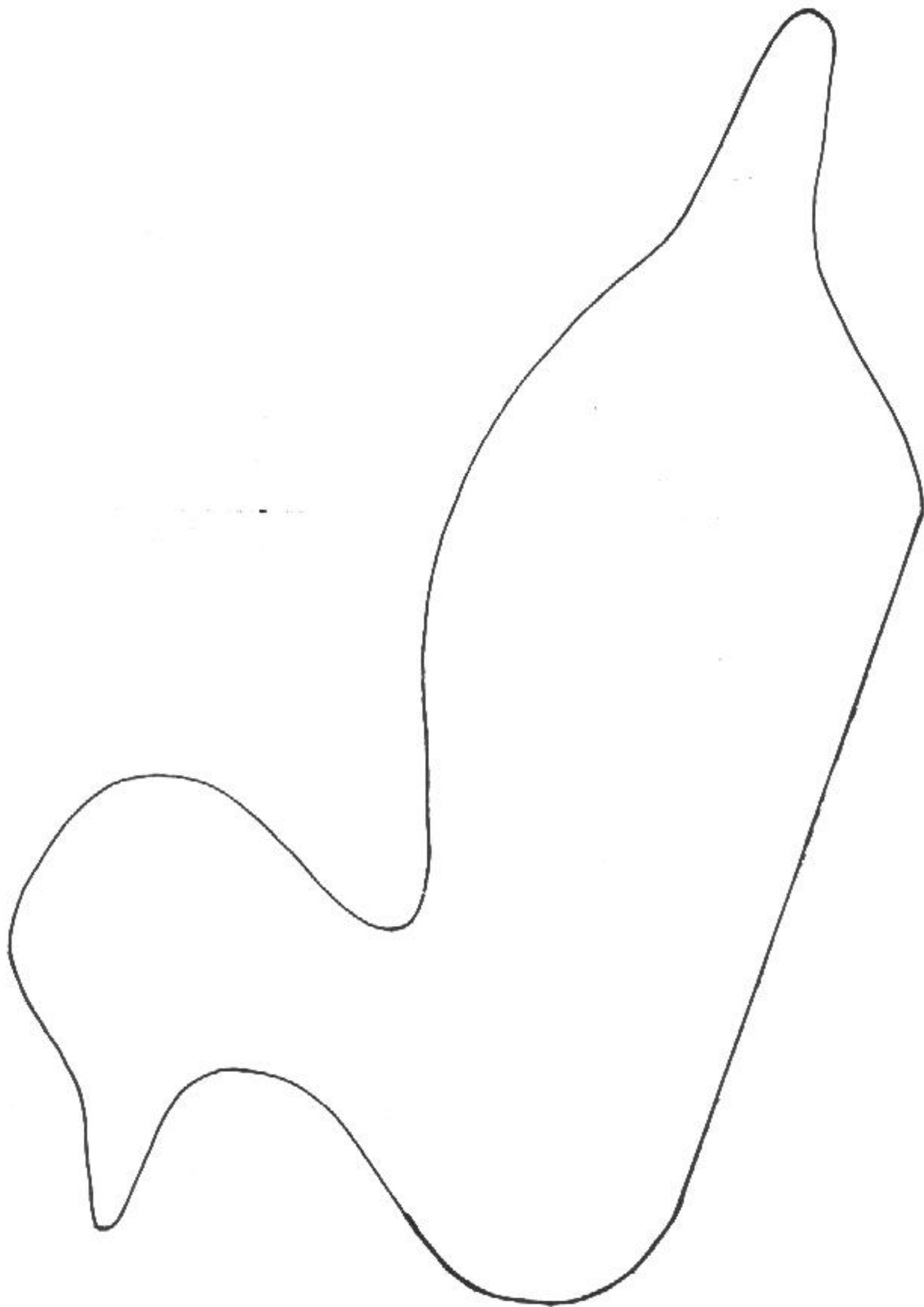

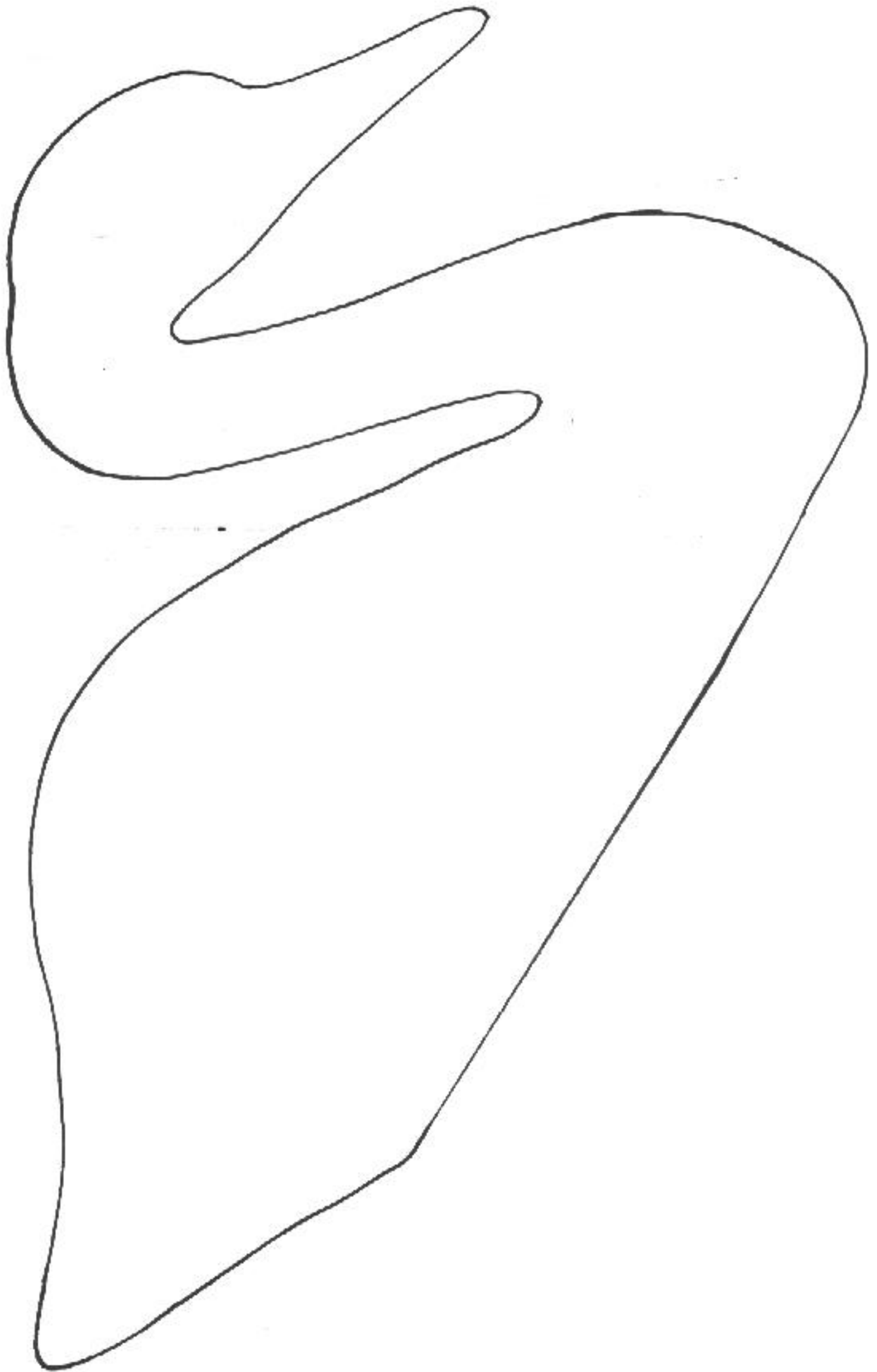

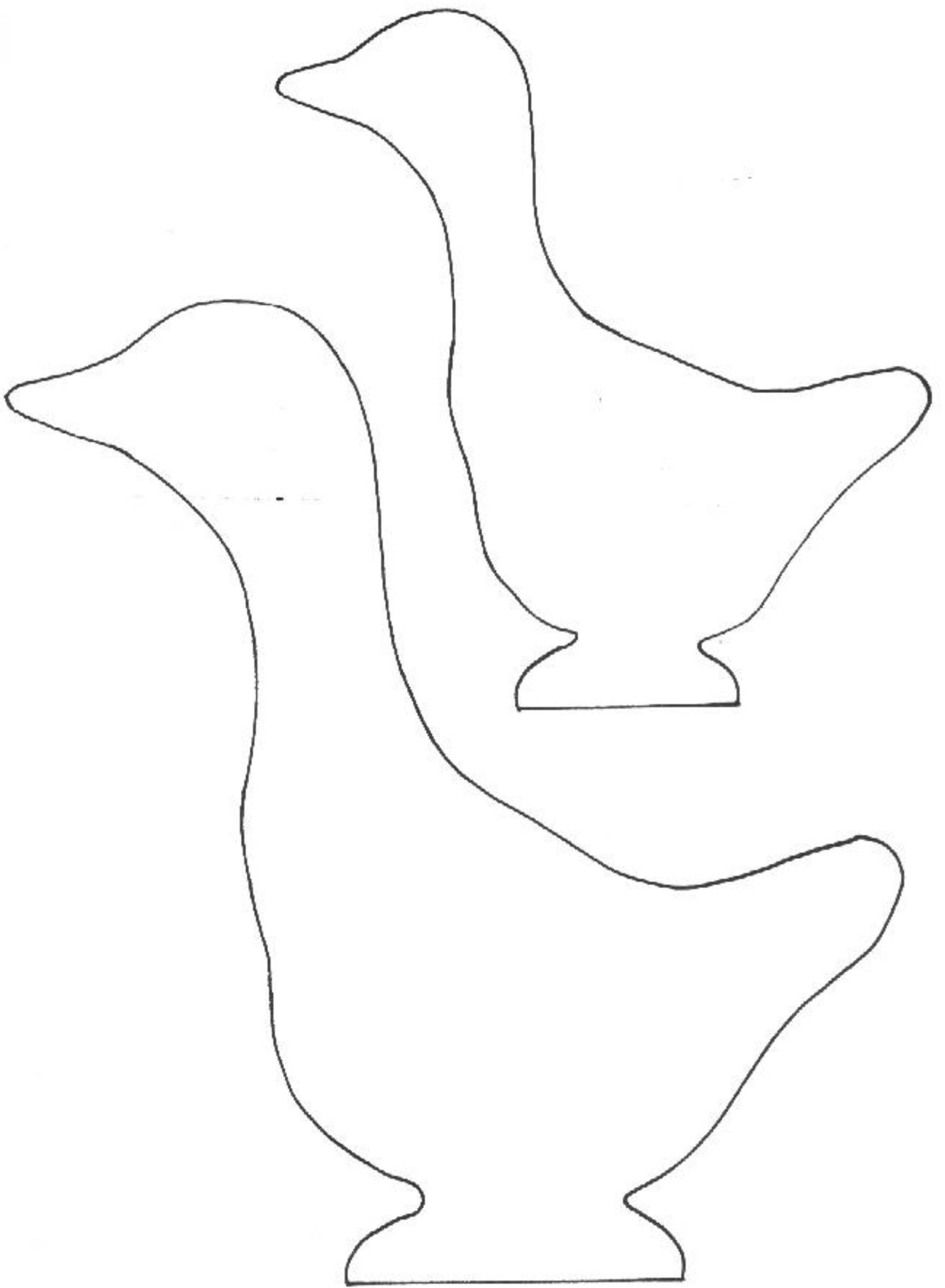

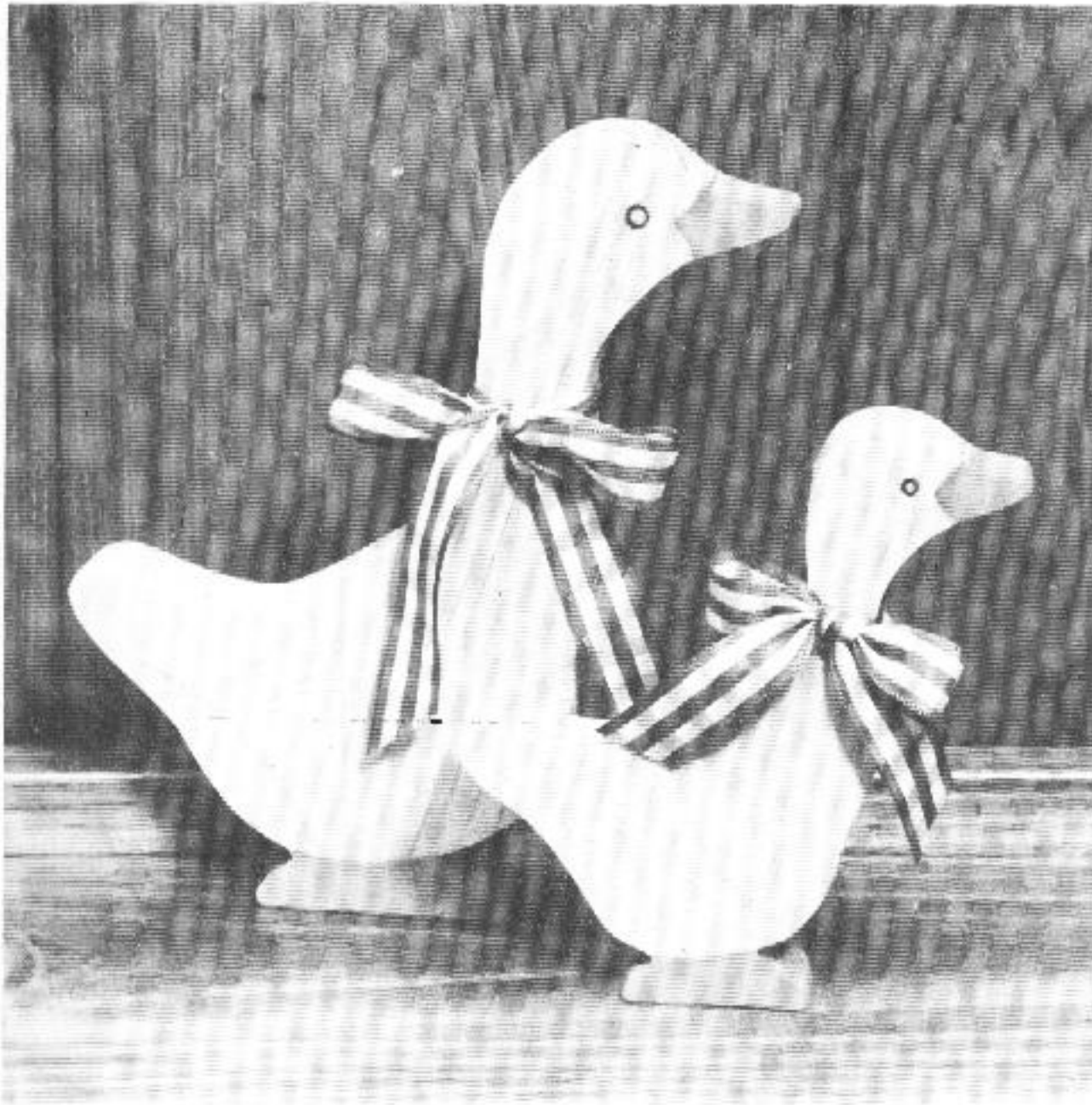

*Geese.*

## **Flowers/Leaves/Fruit**

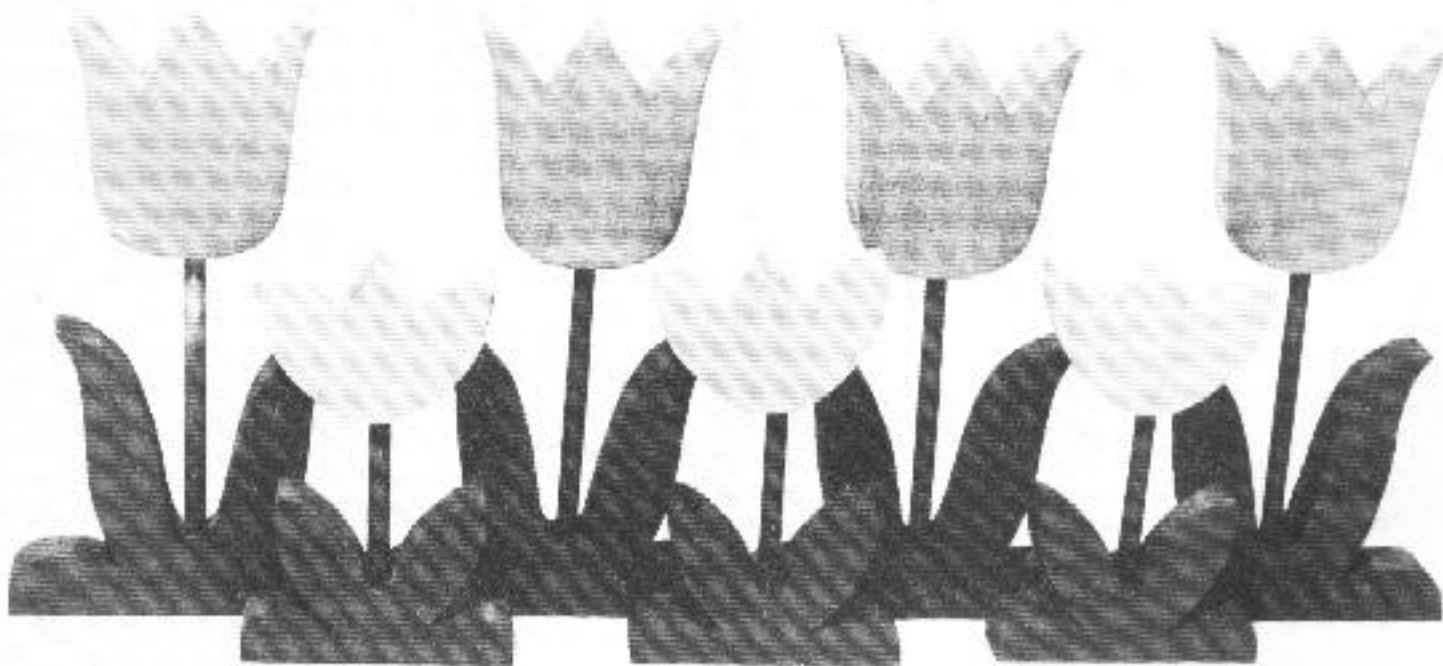

*Tulips. Patterns can be found on the following page.*

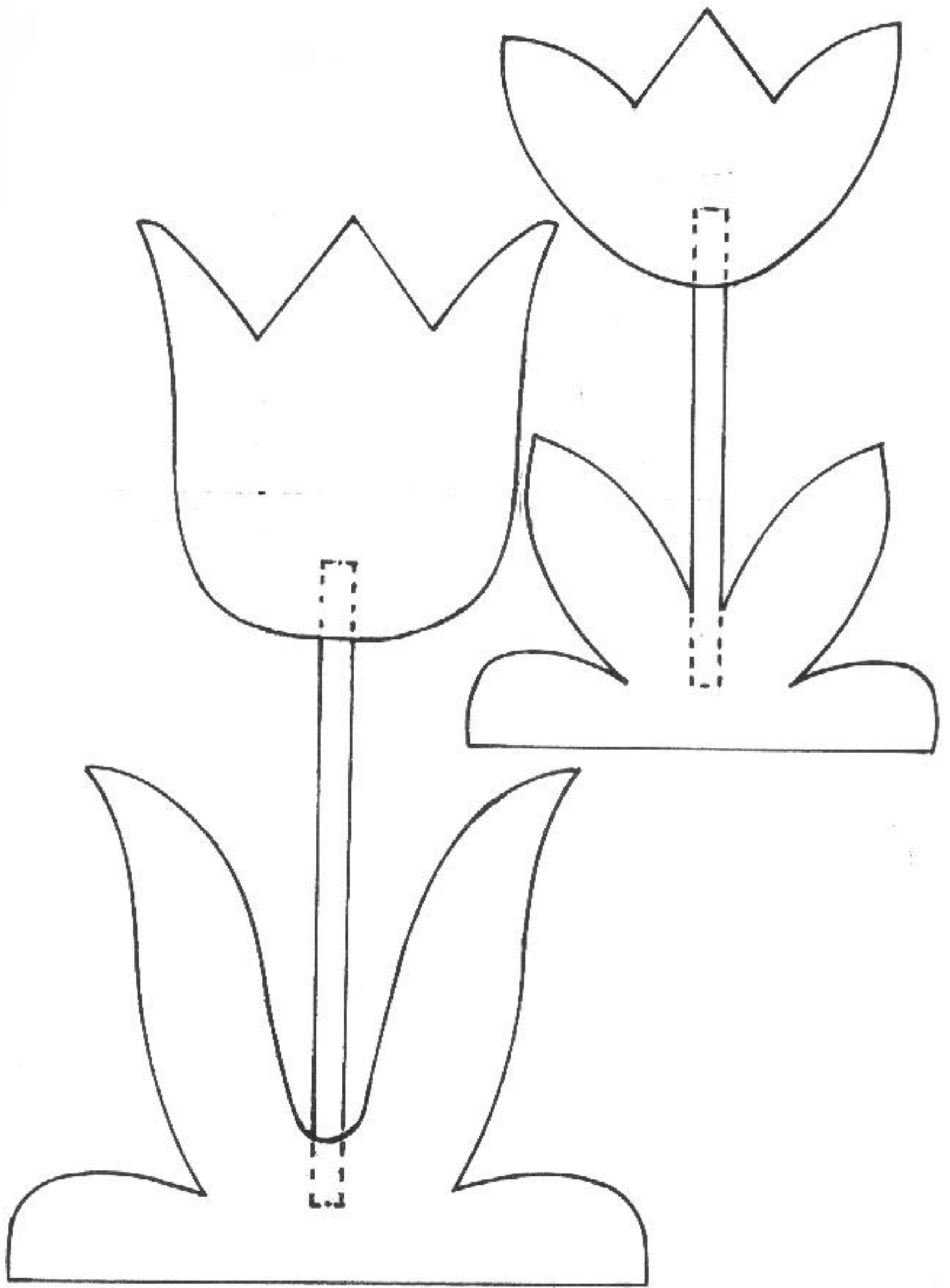

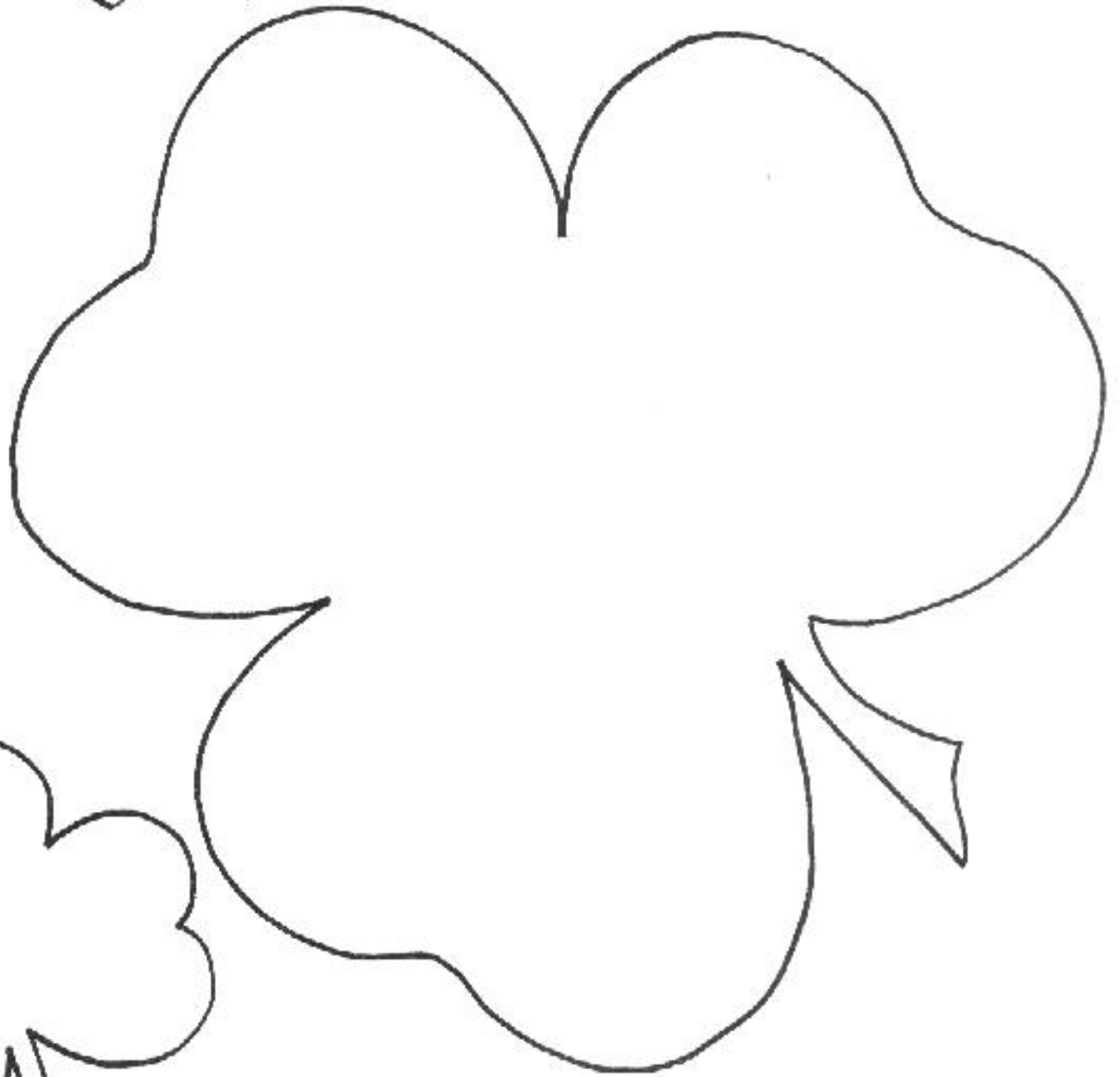
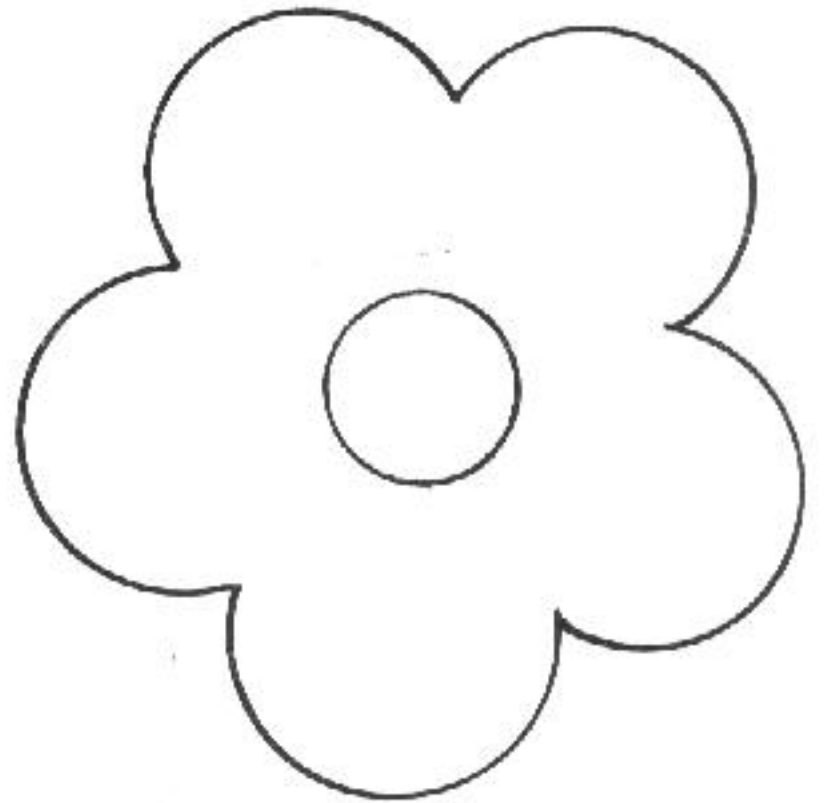
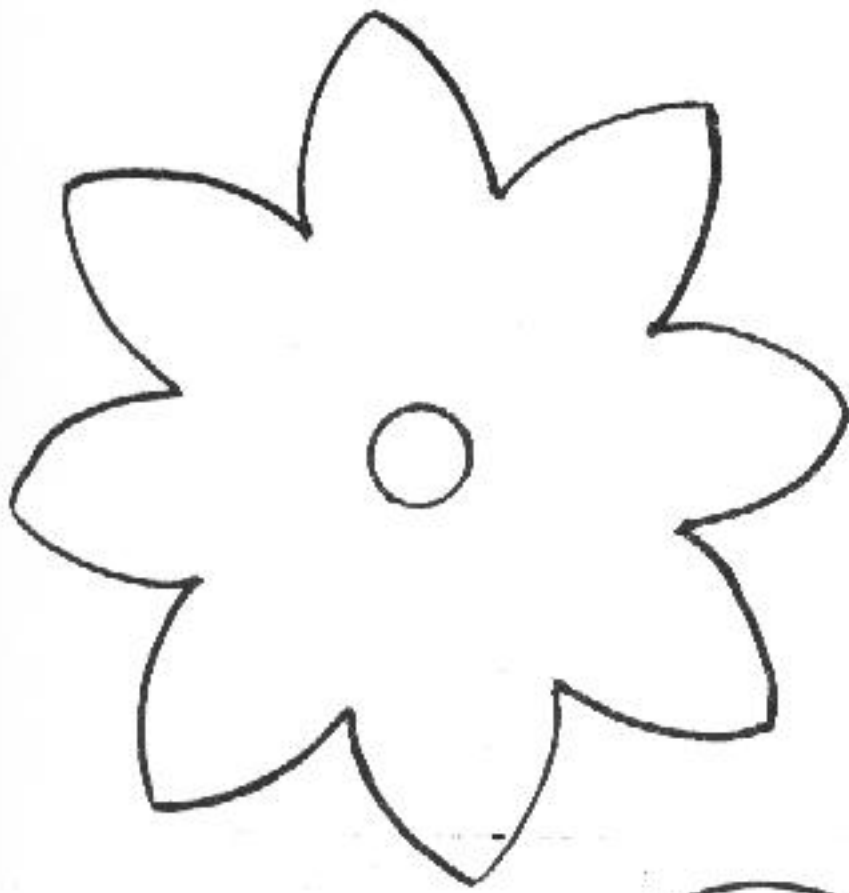

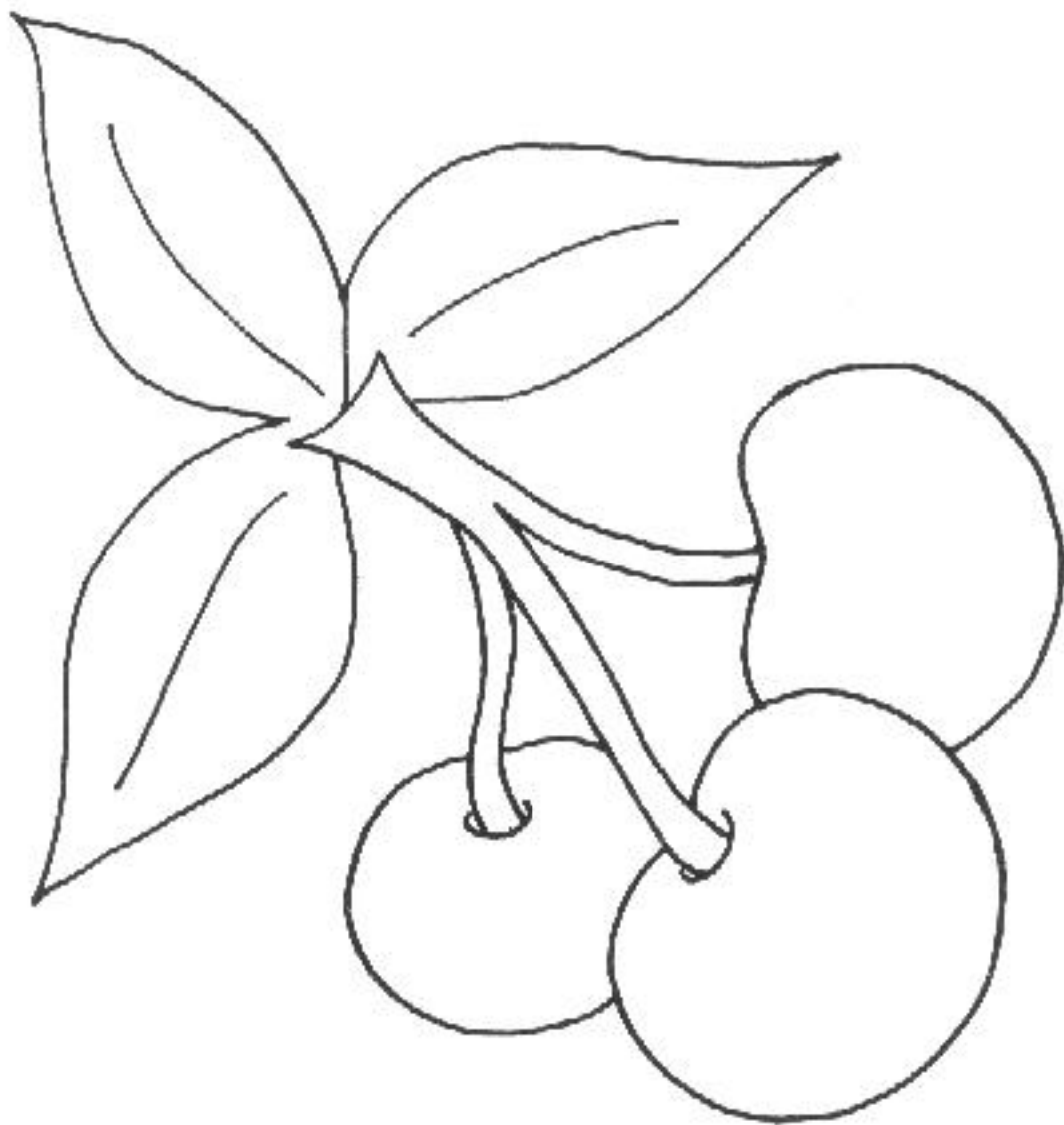
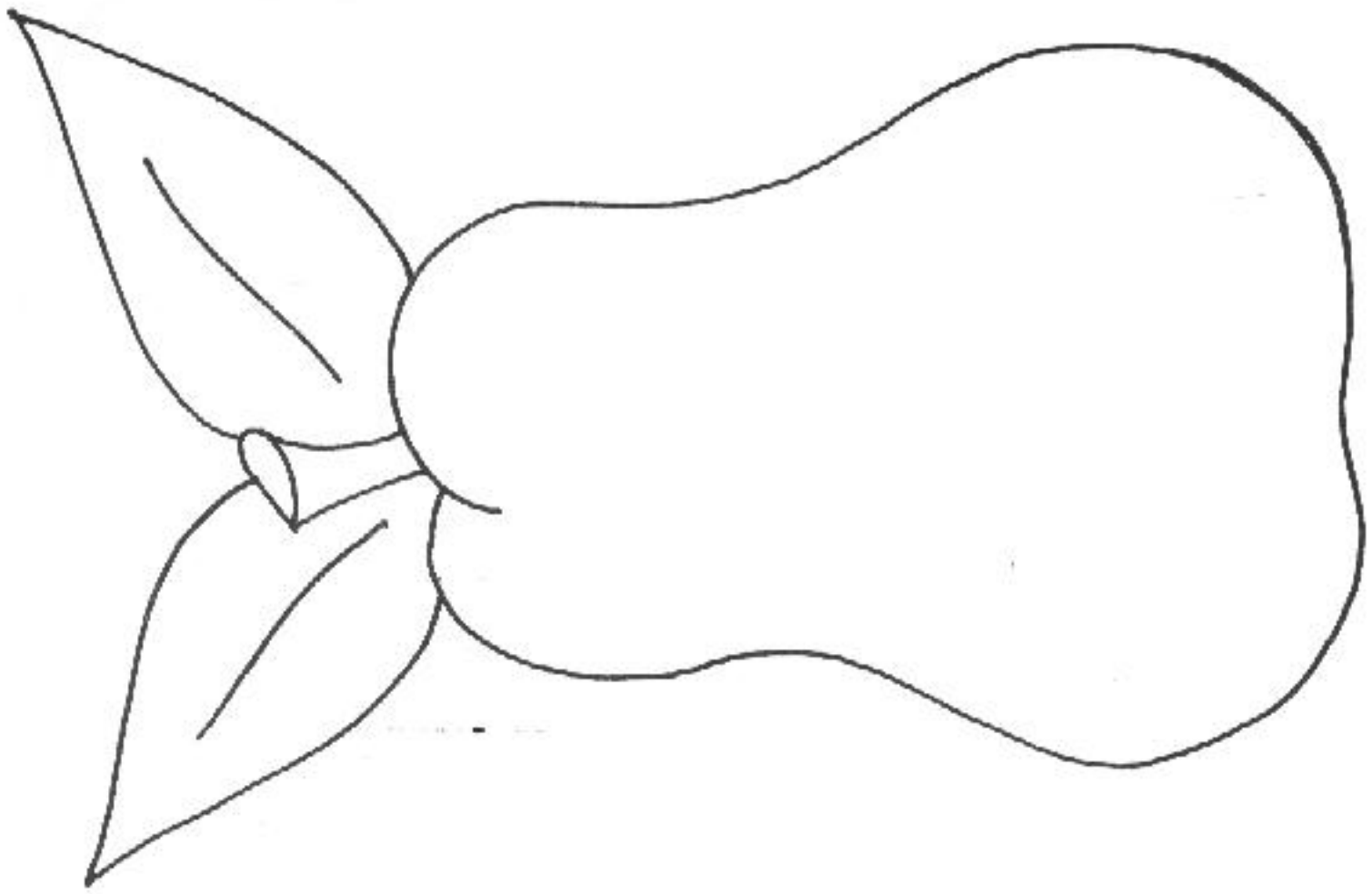



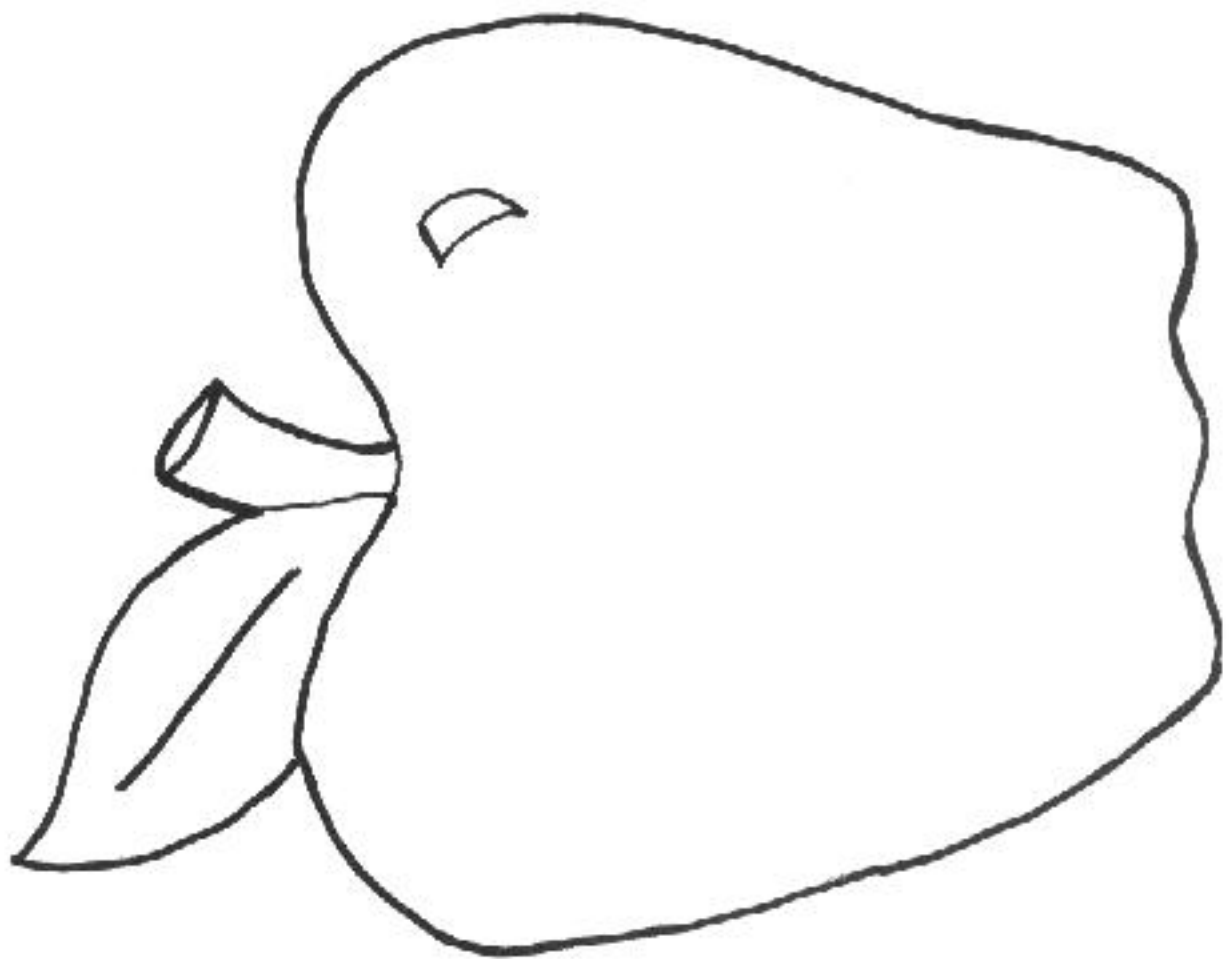
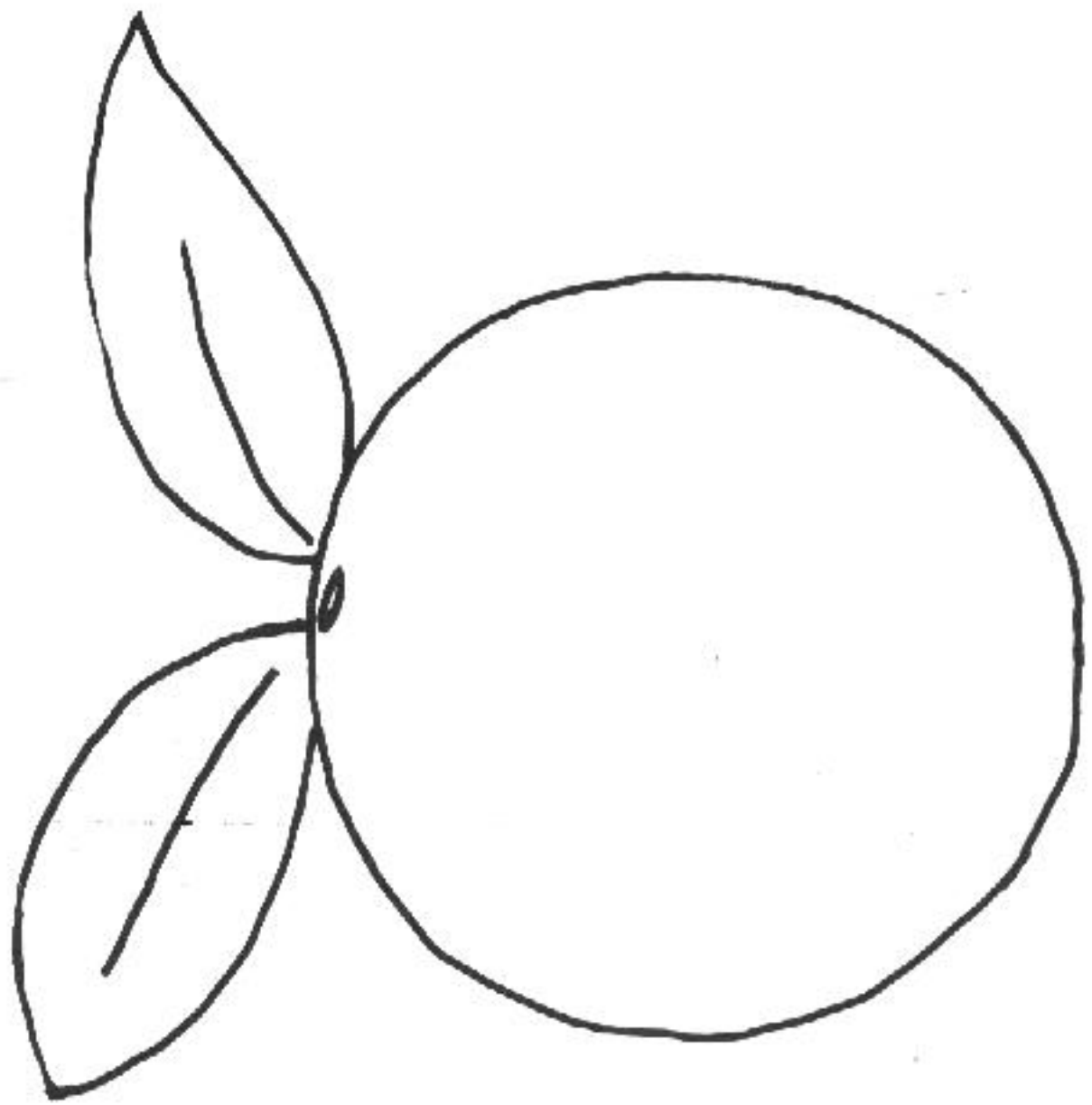



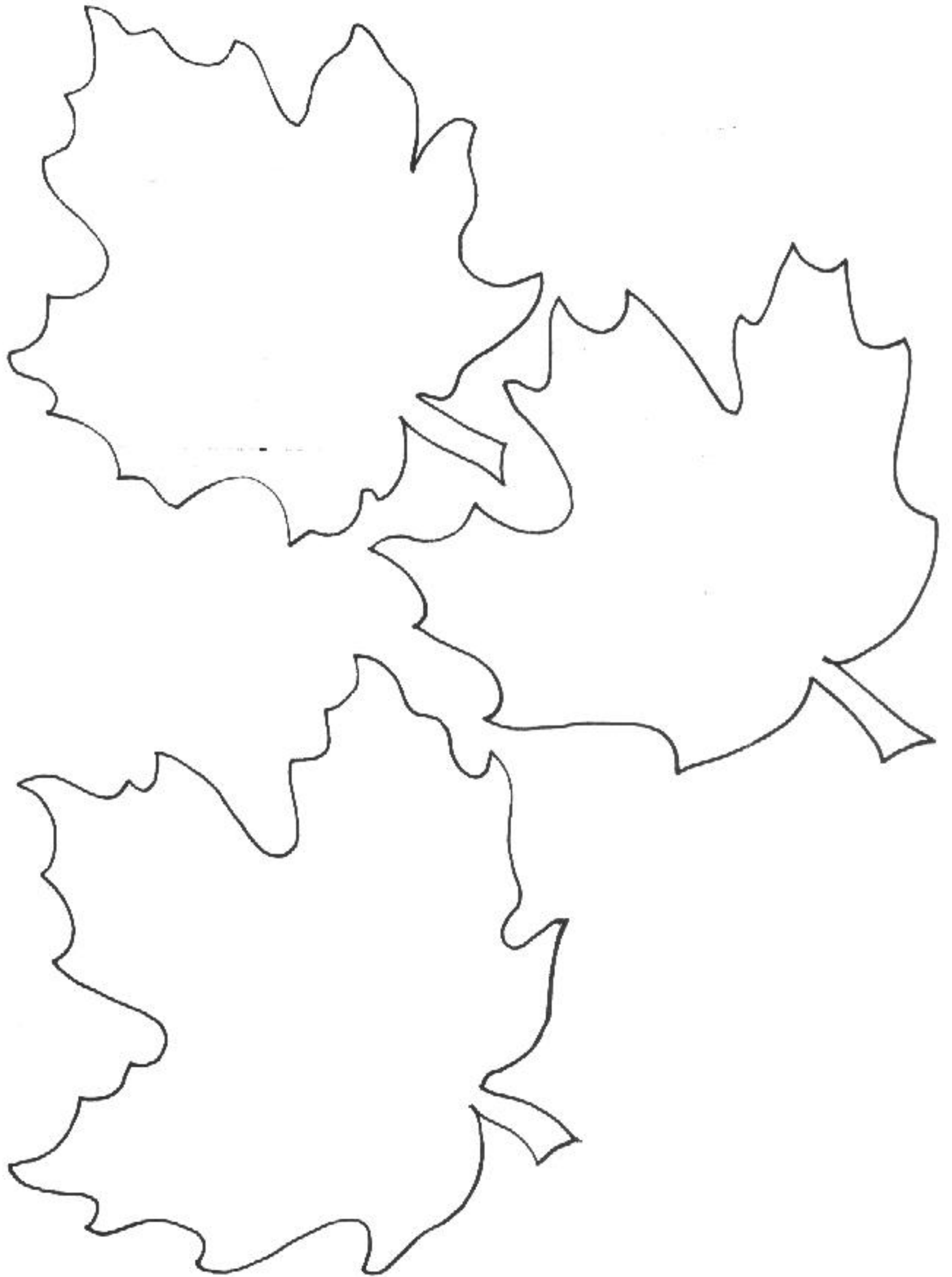

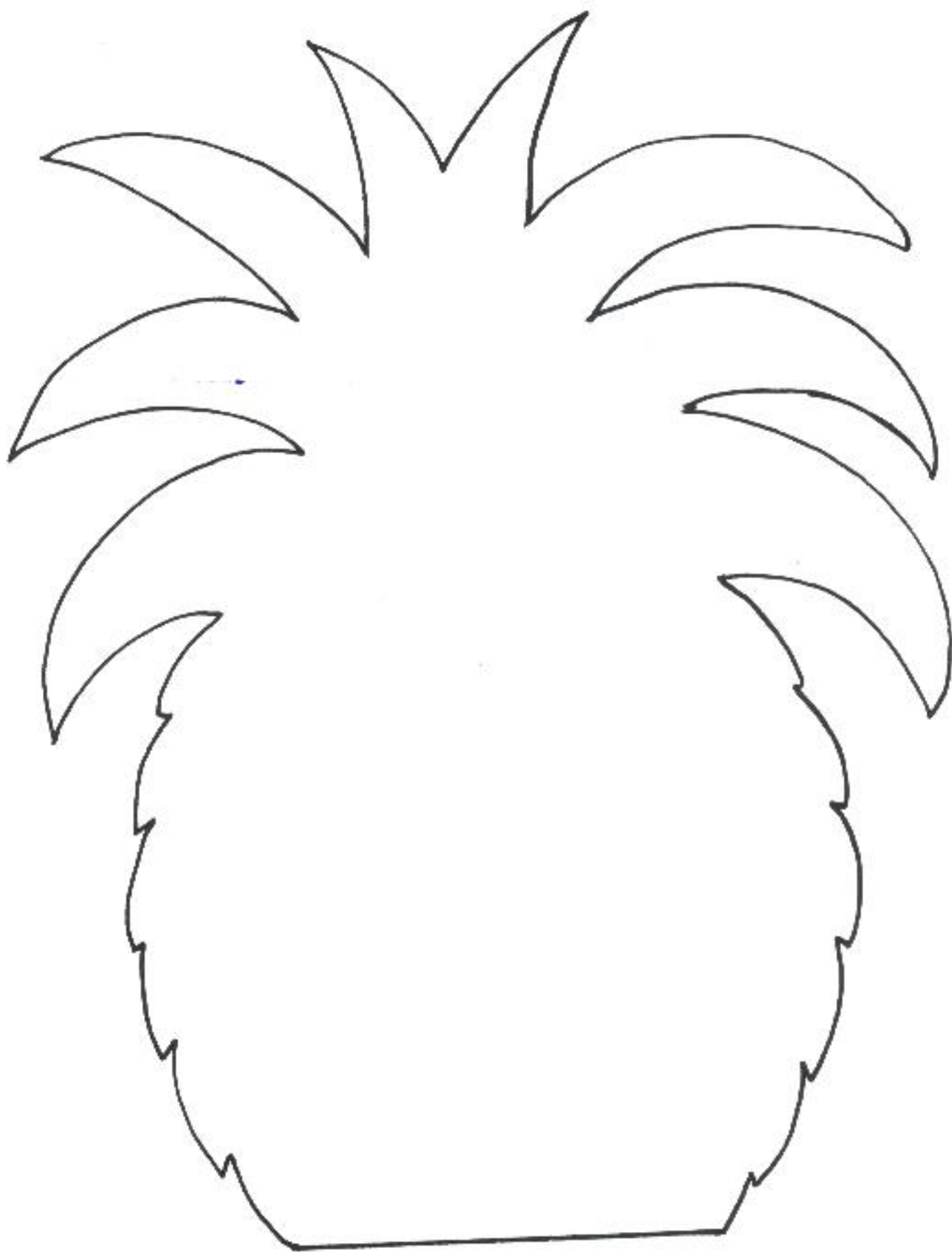

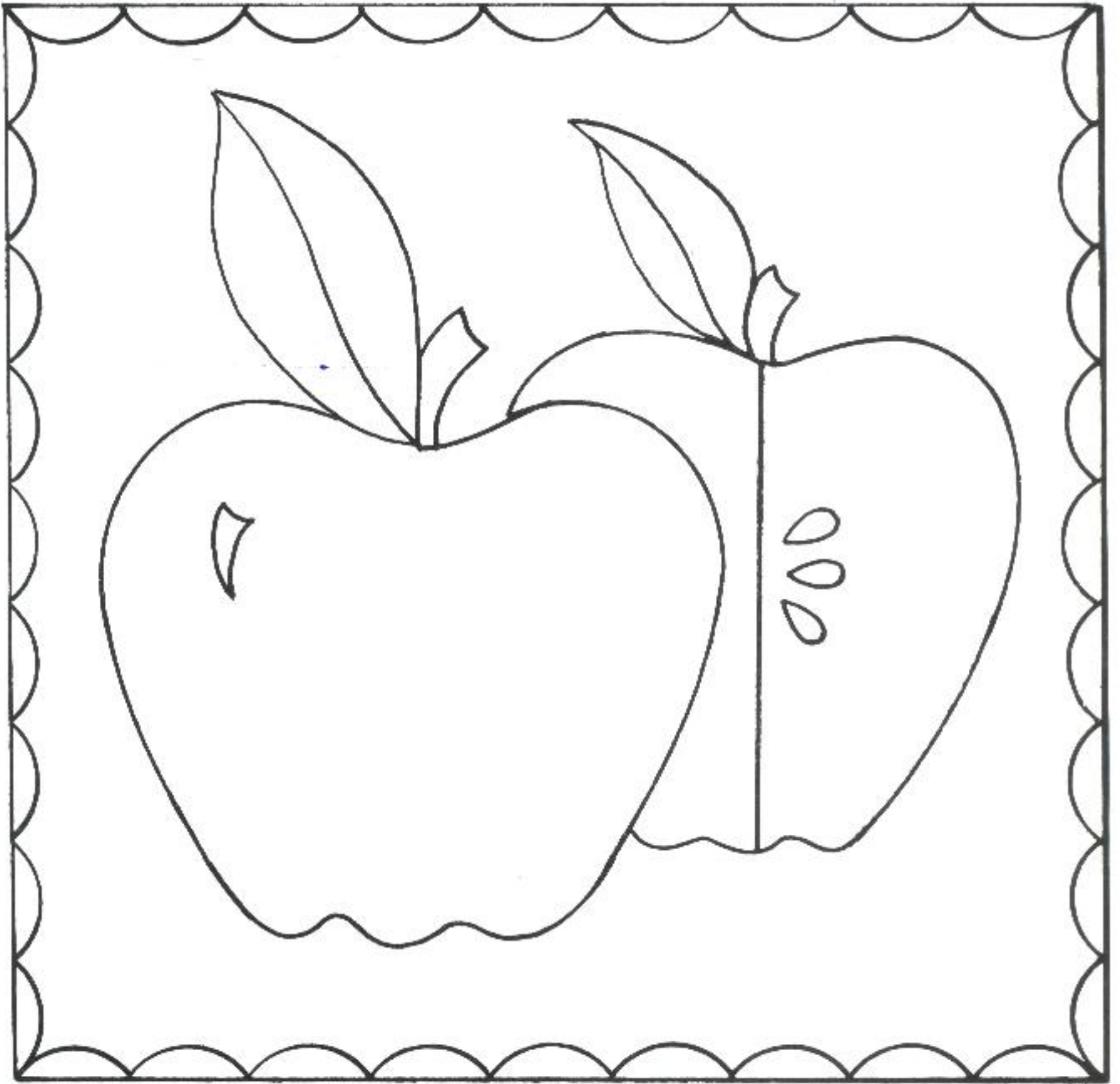

# Creatures of the Deep

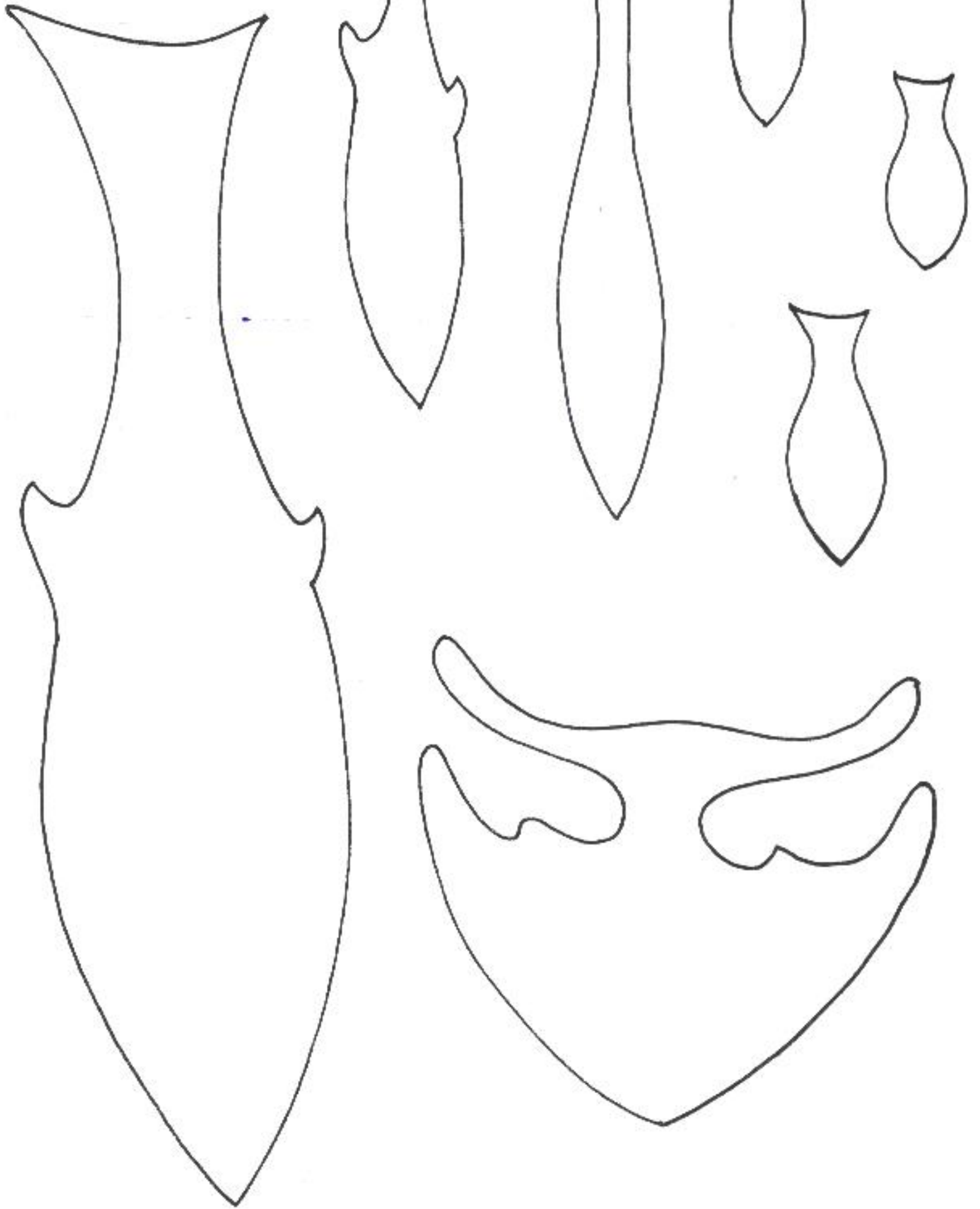

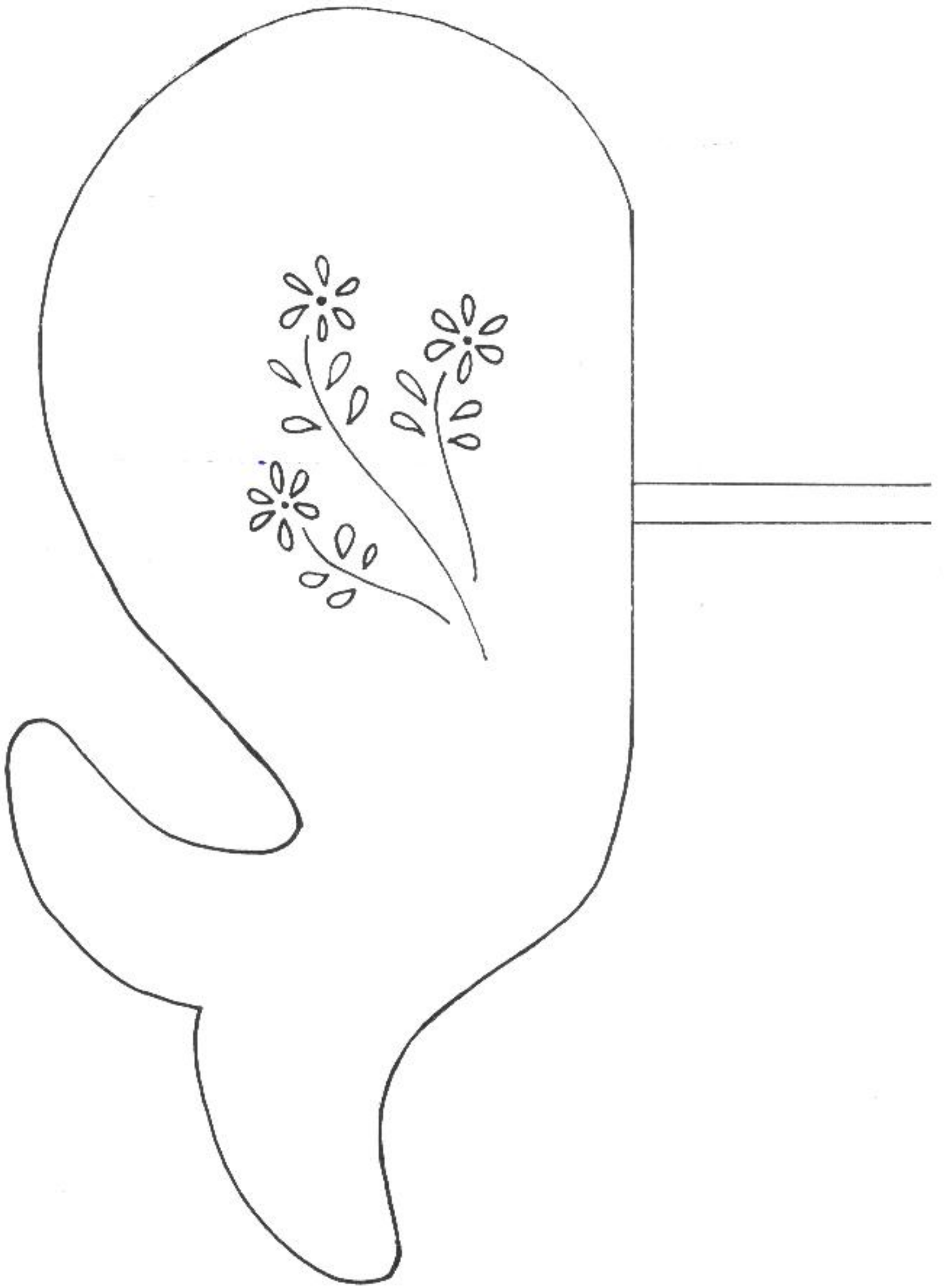

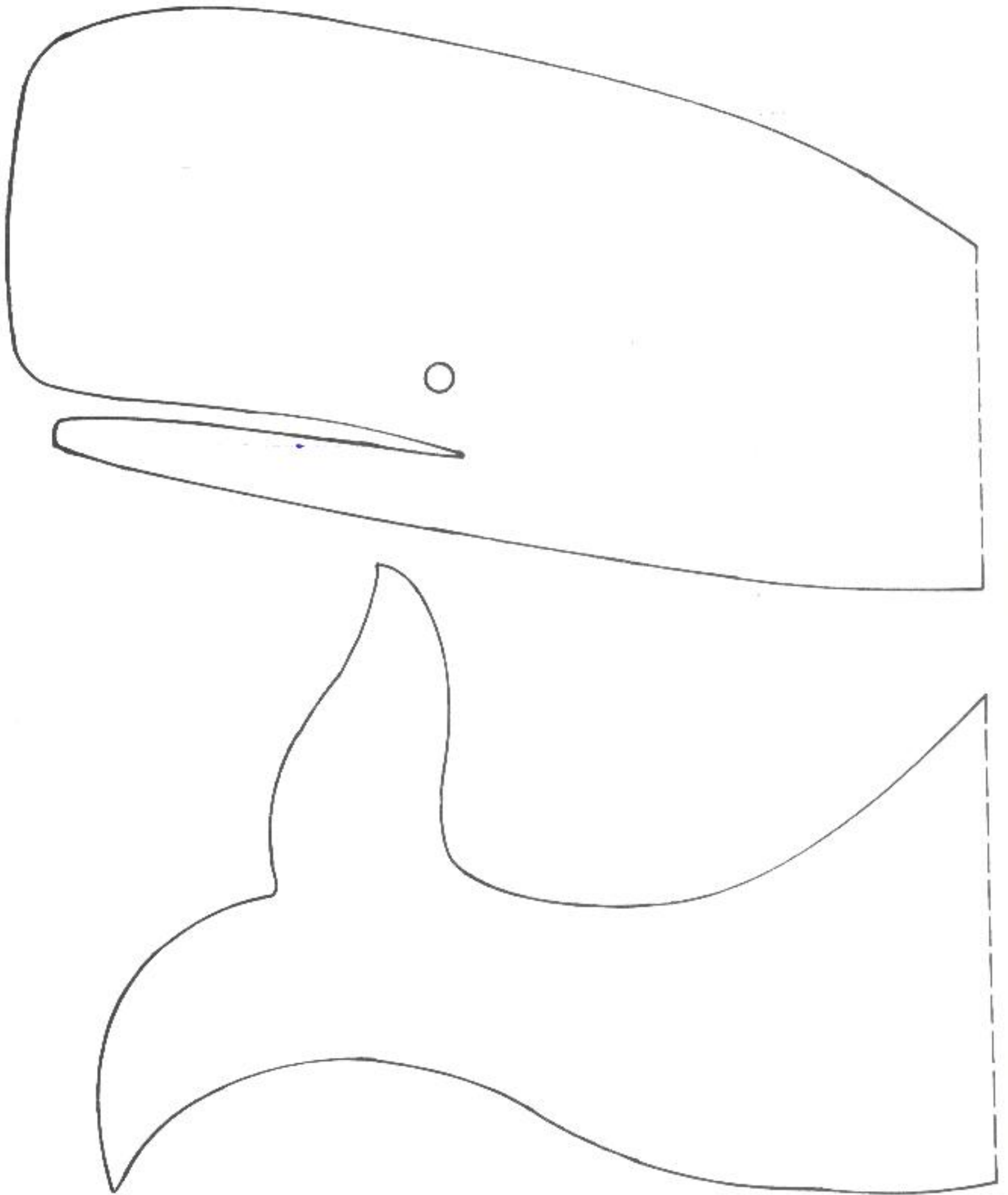



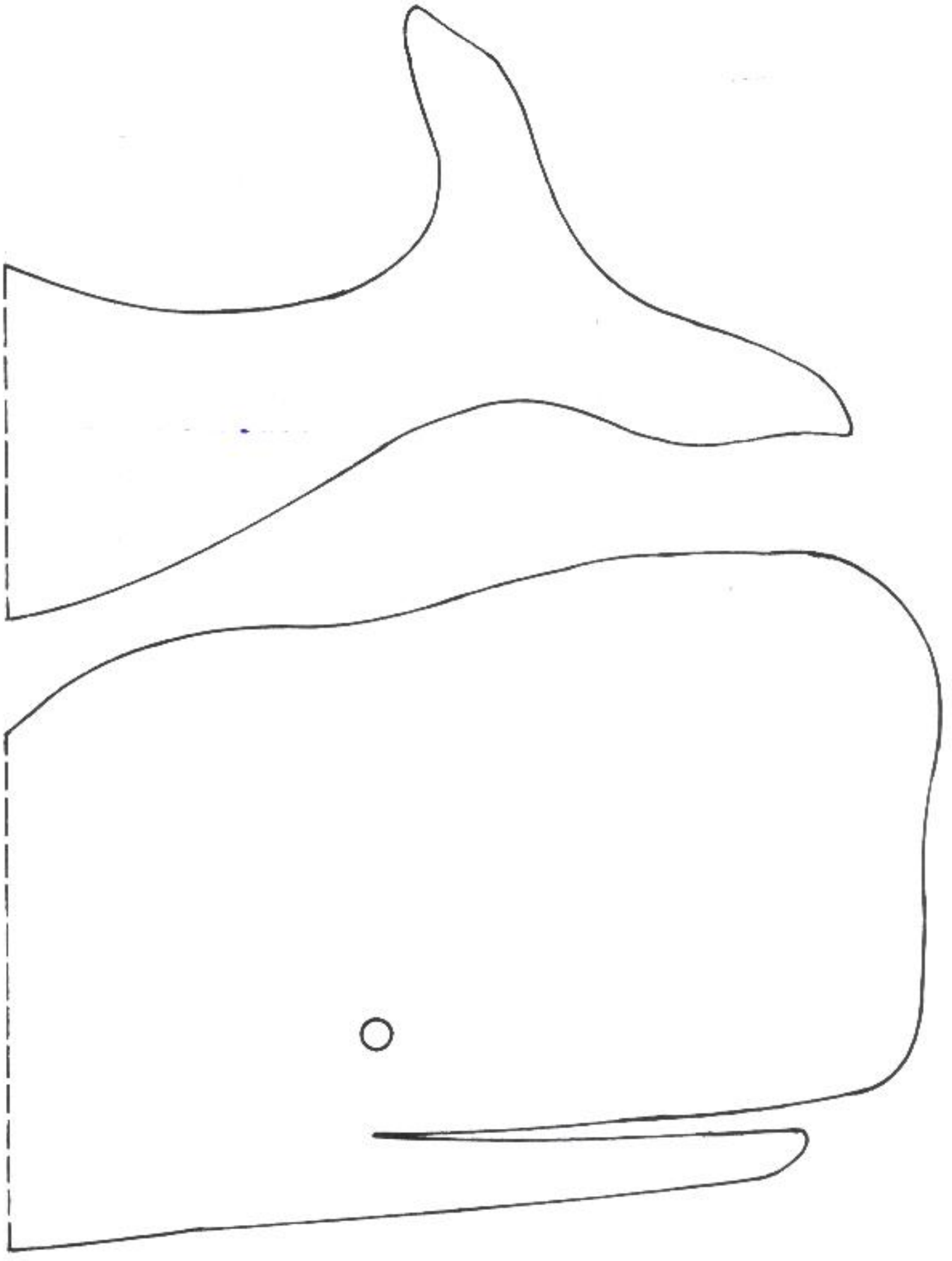

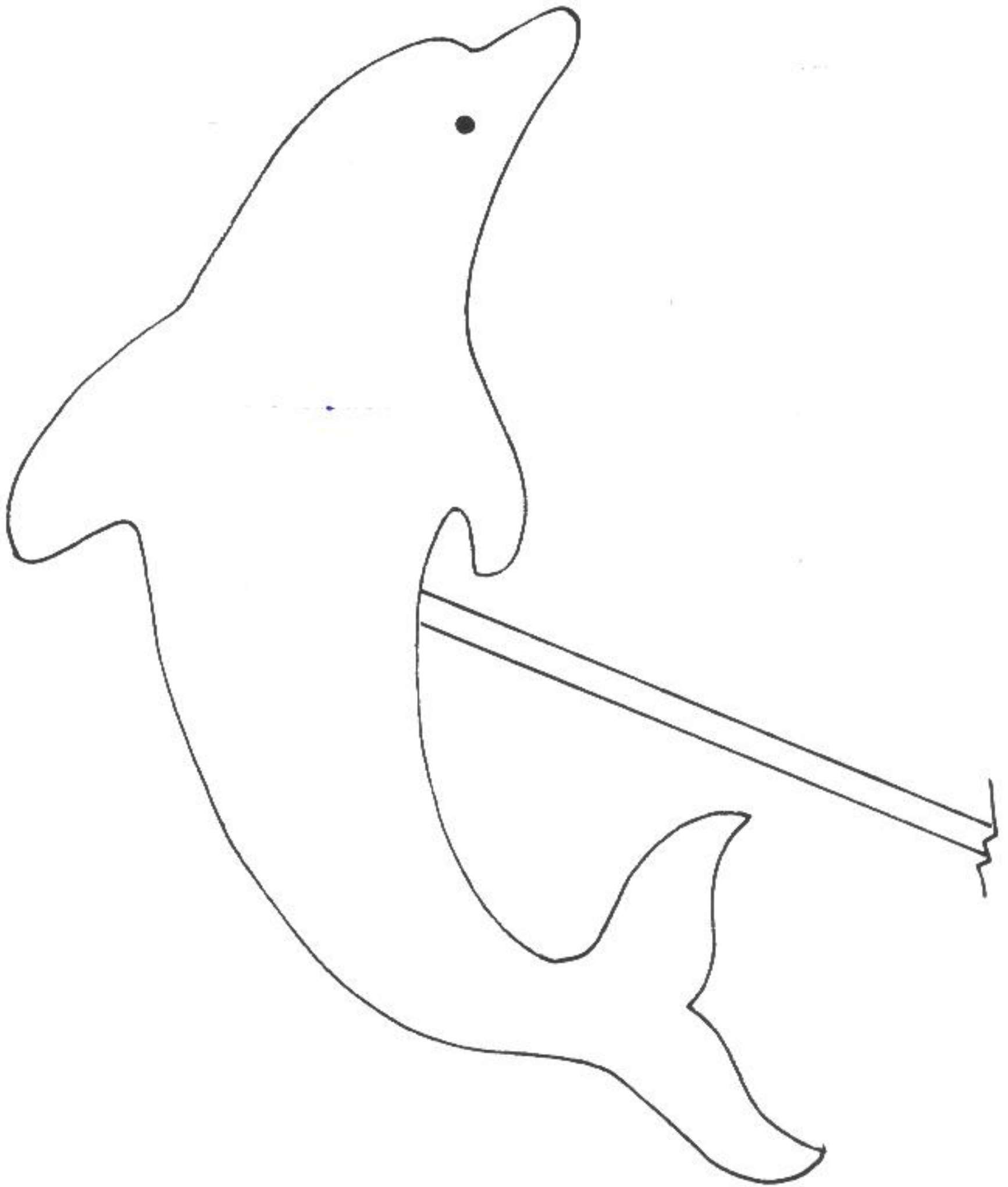

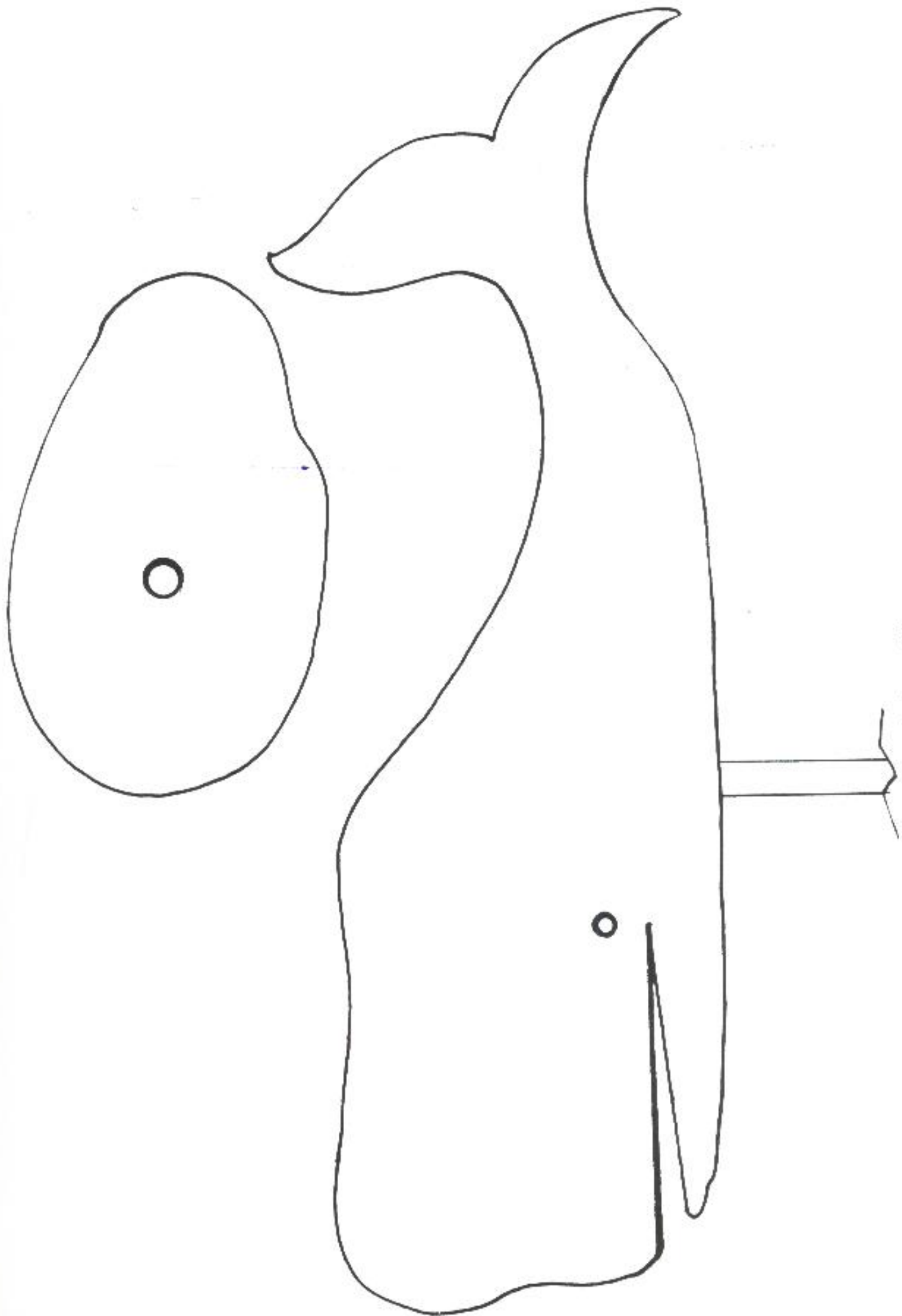

Whale and base.

# Birds

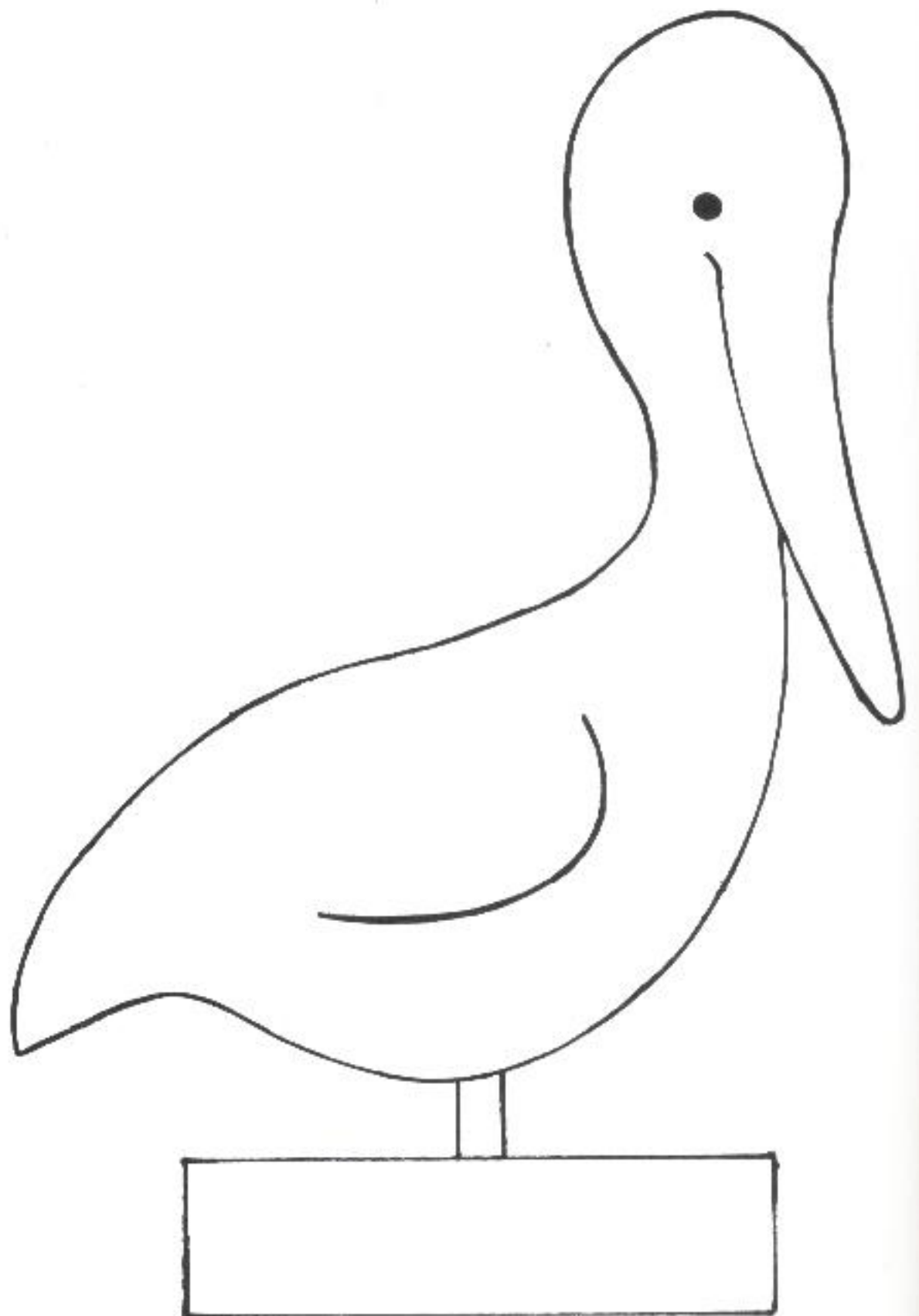

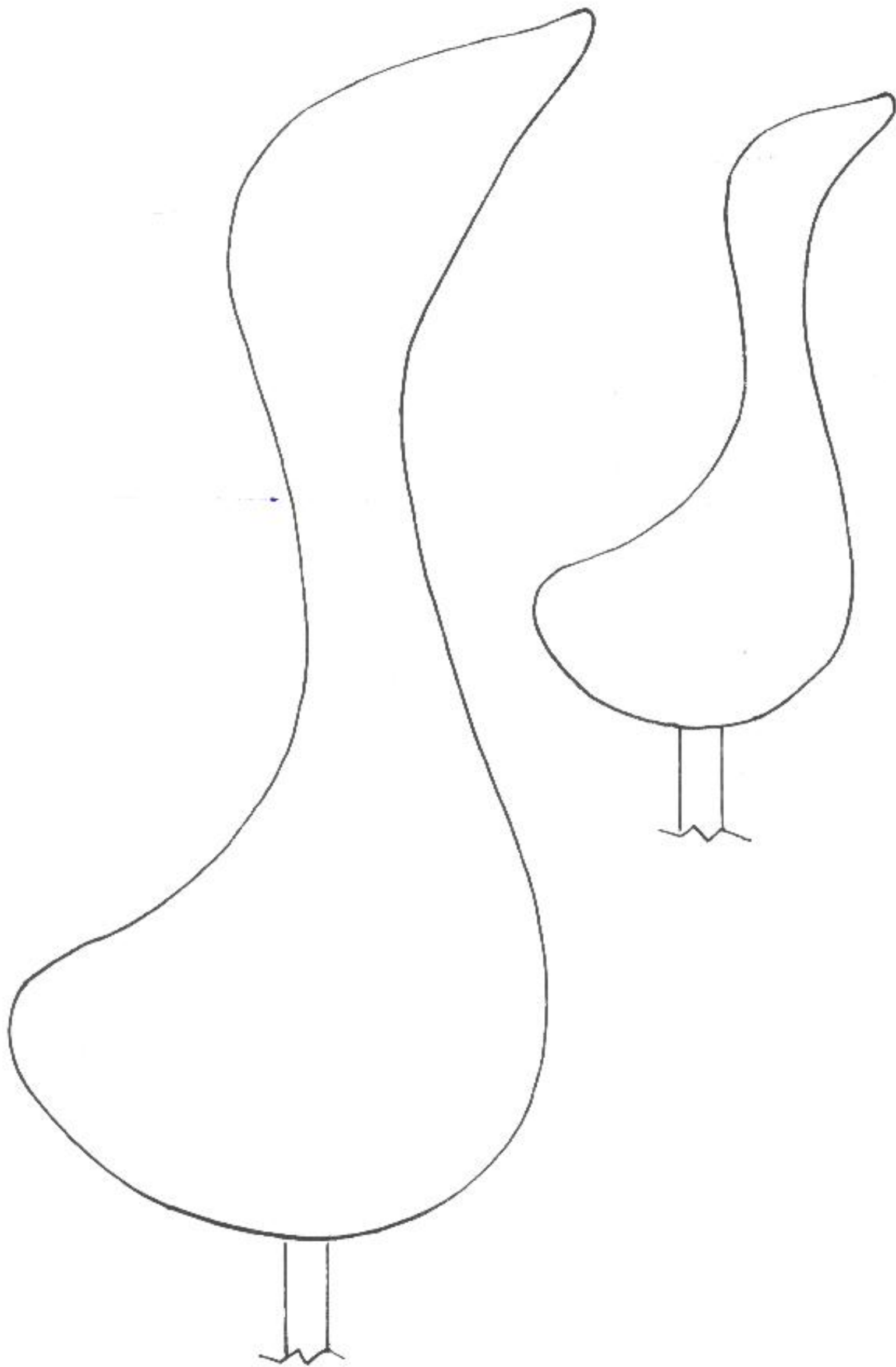

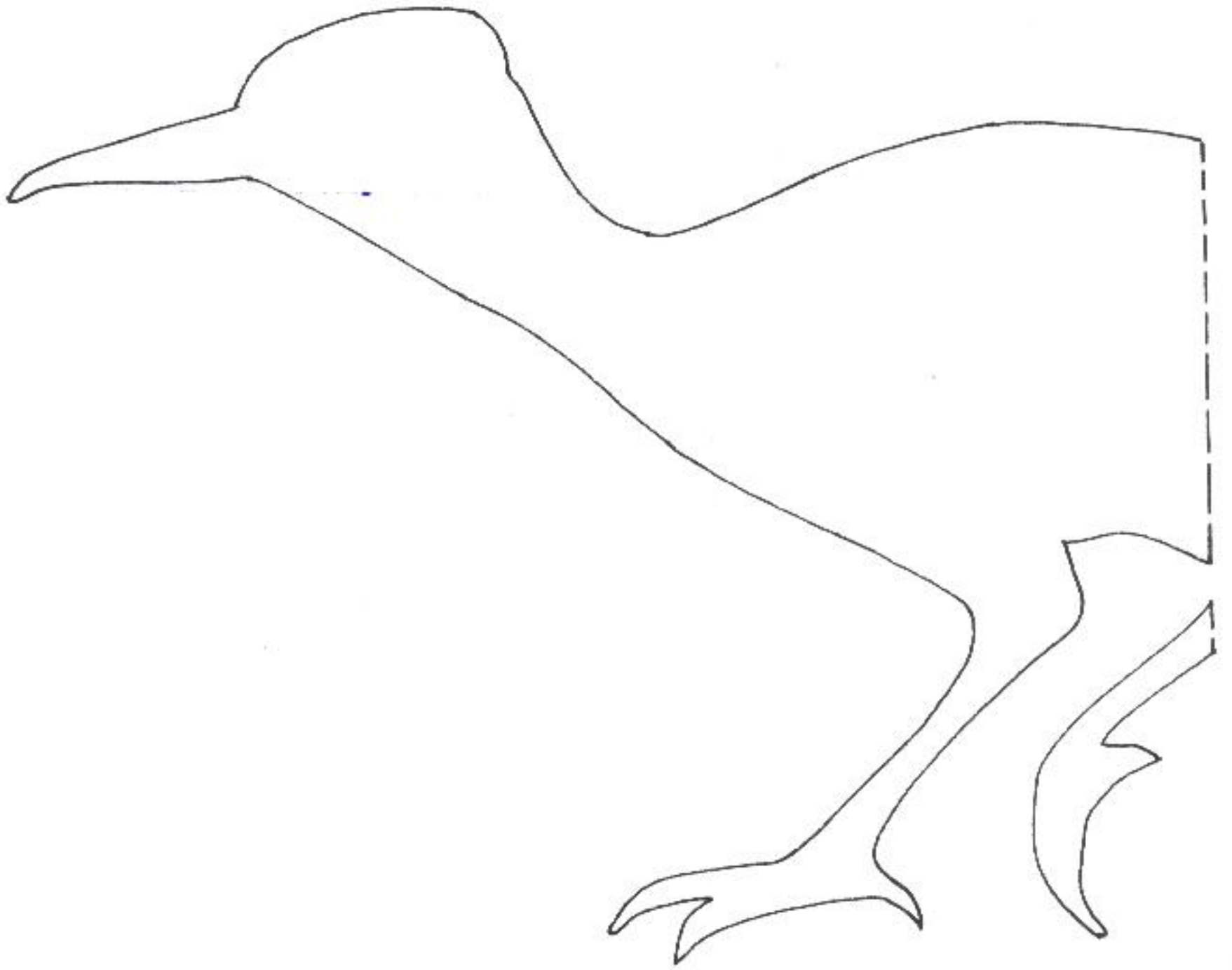

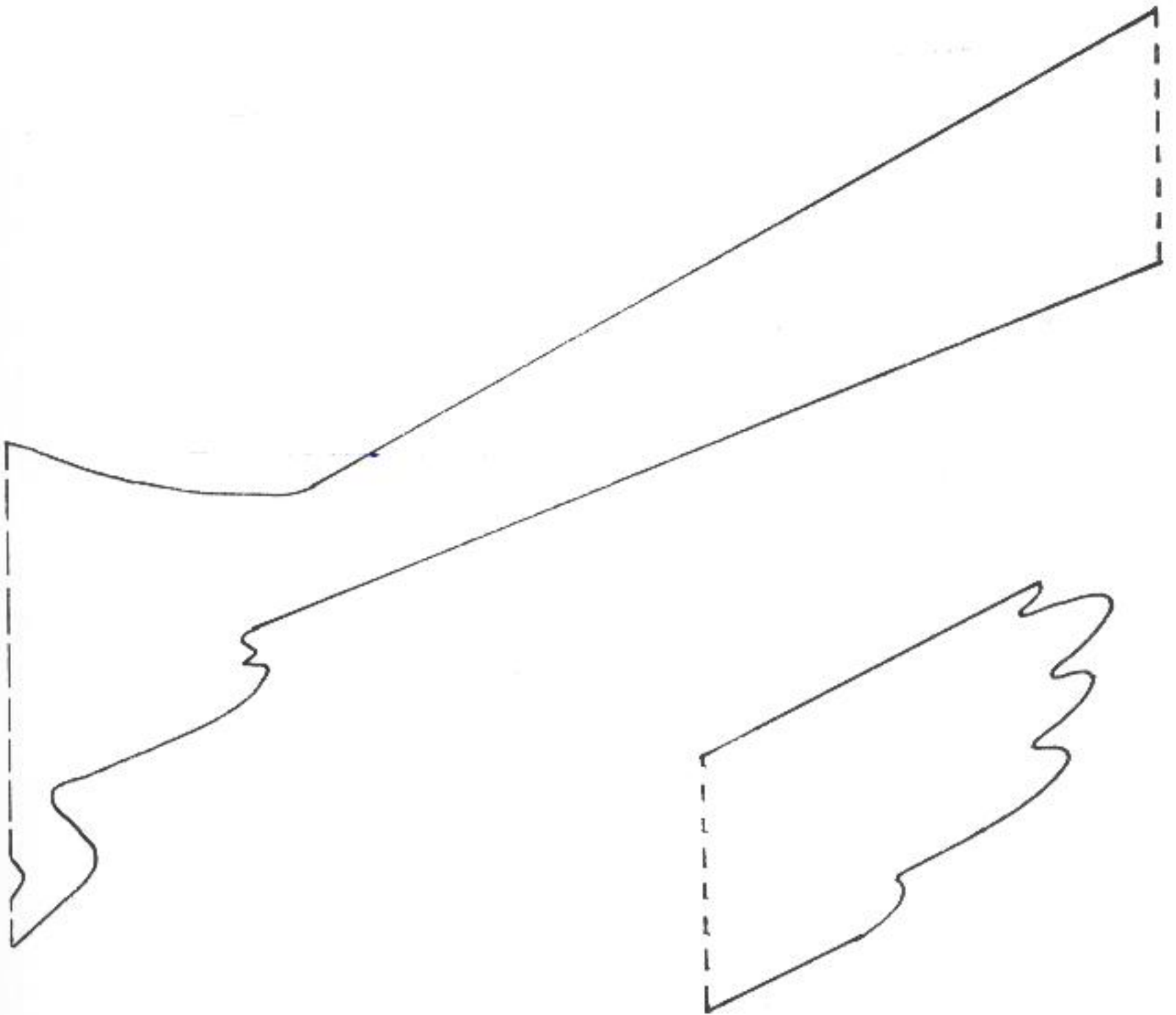

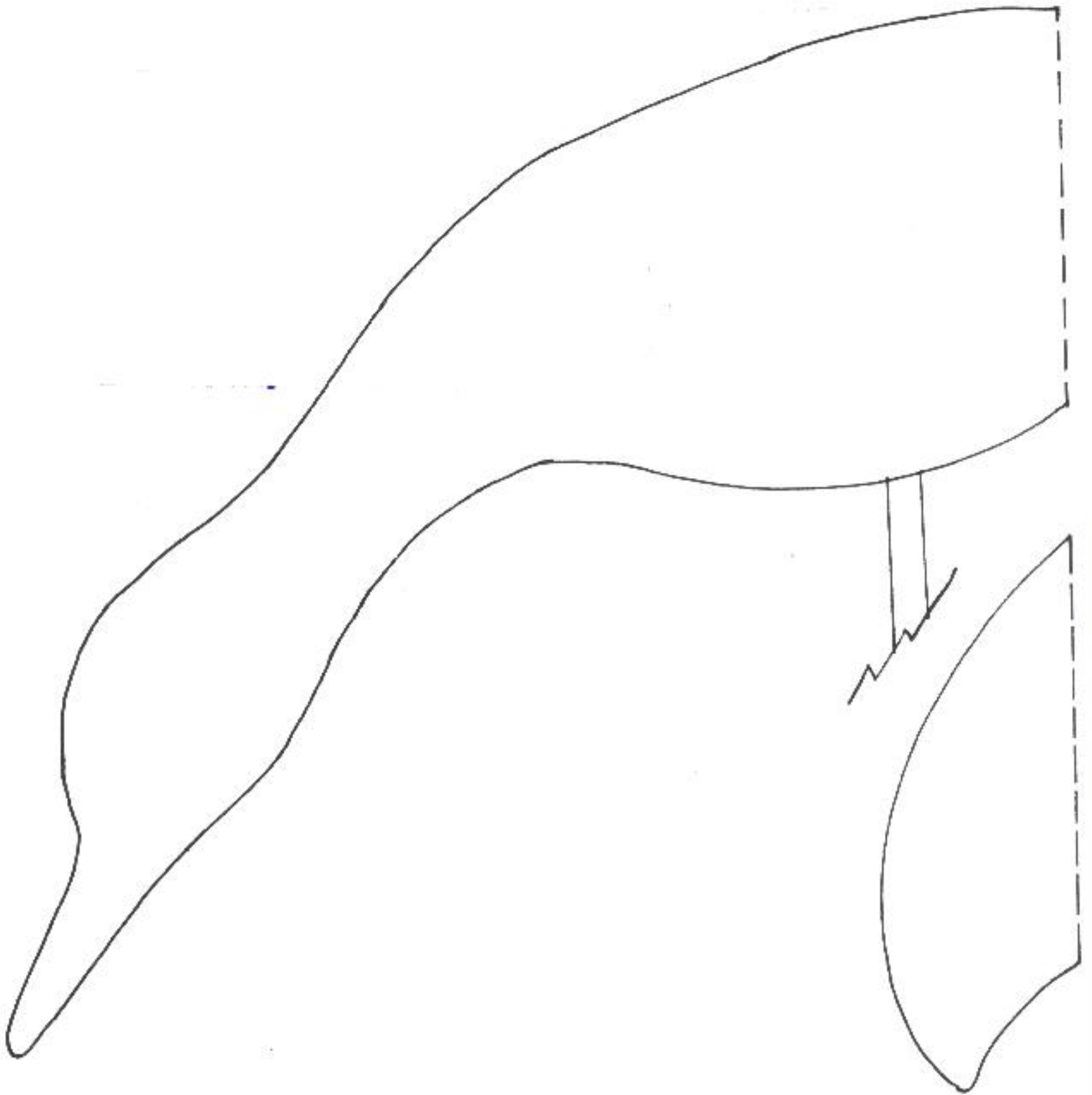



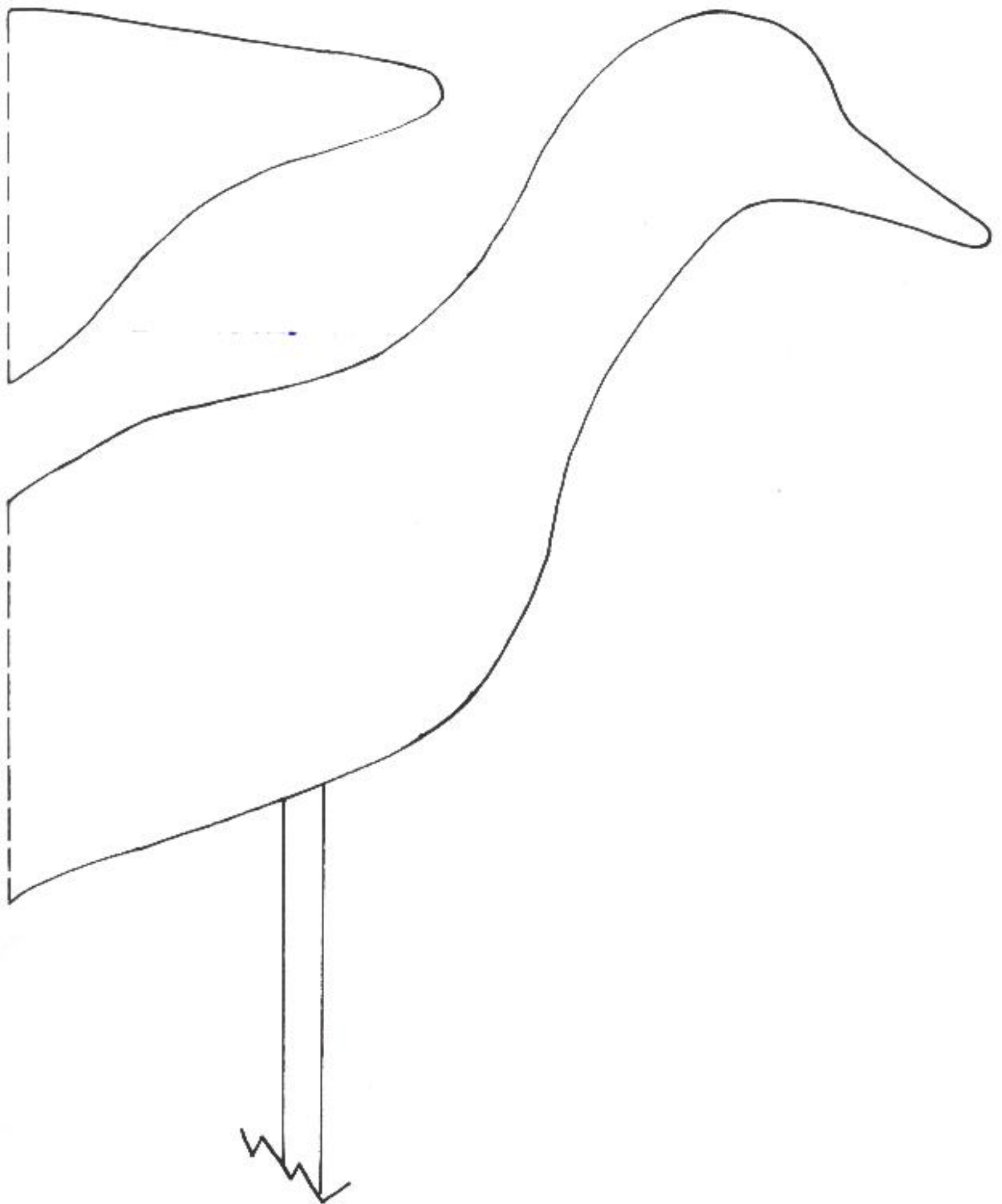

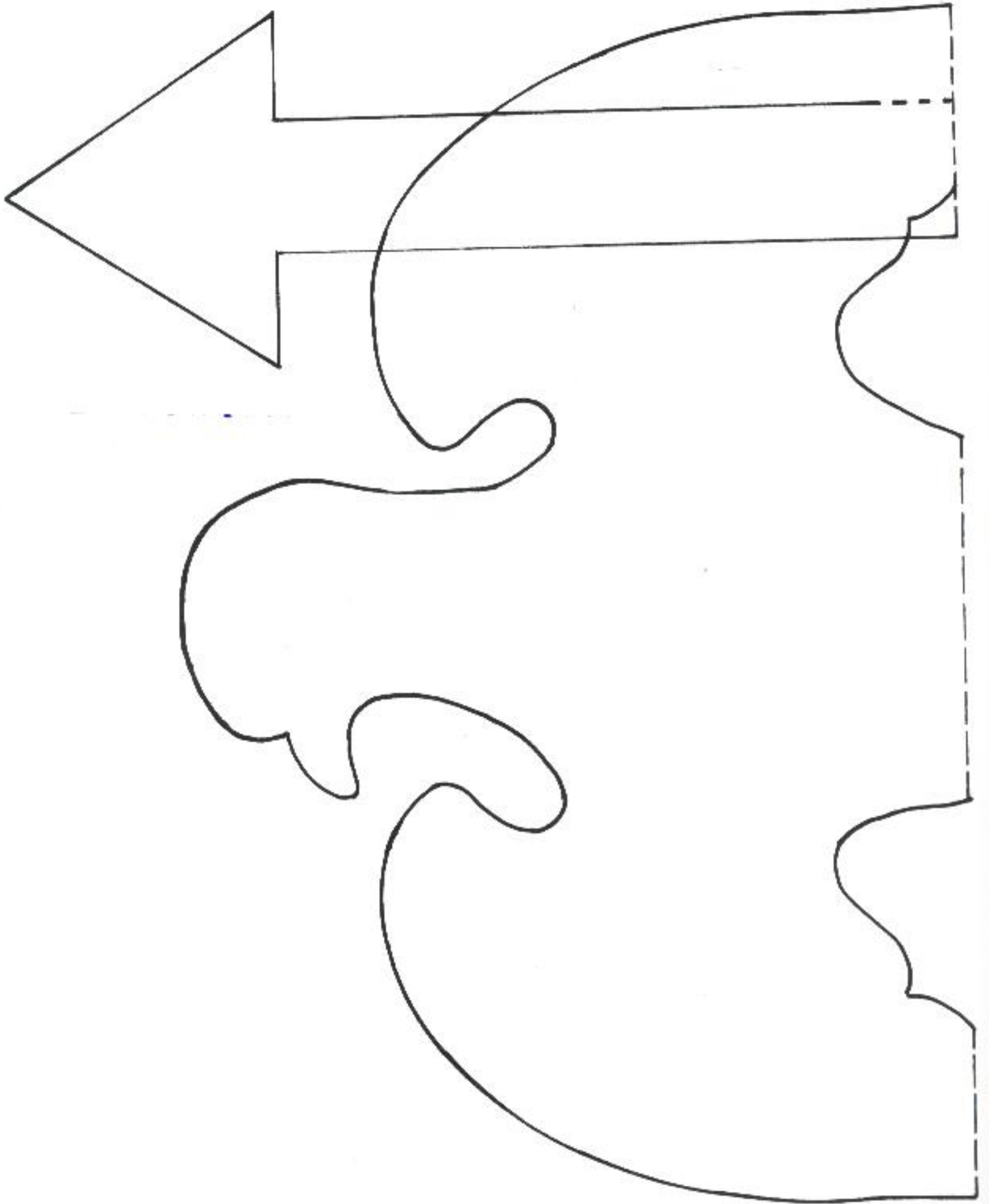

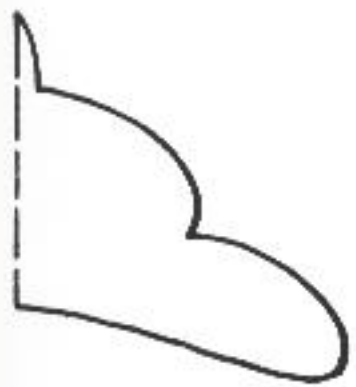
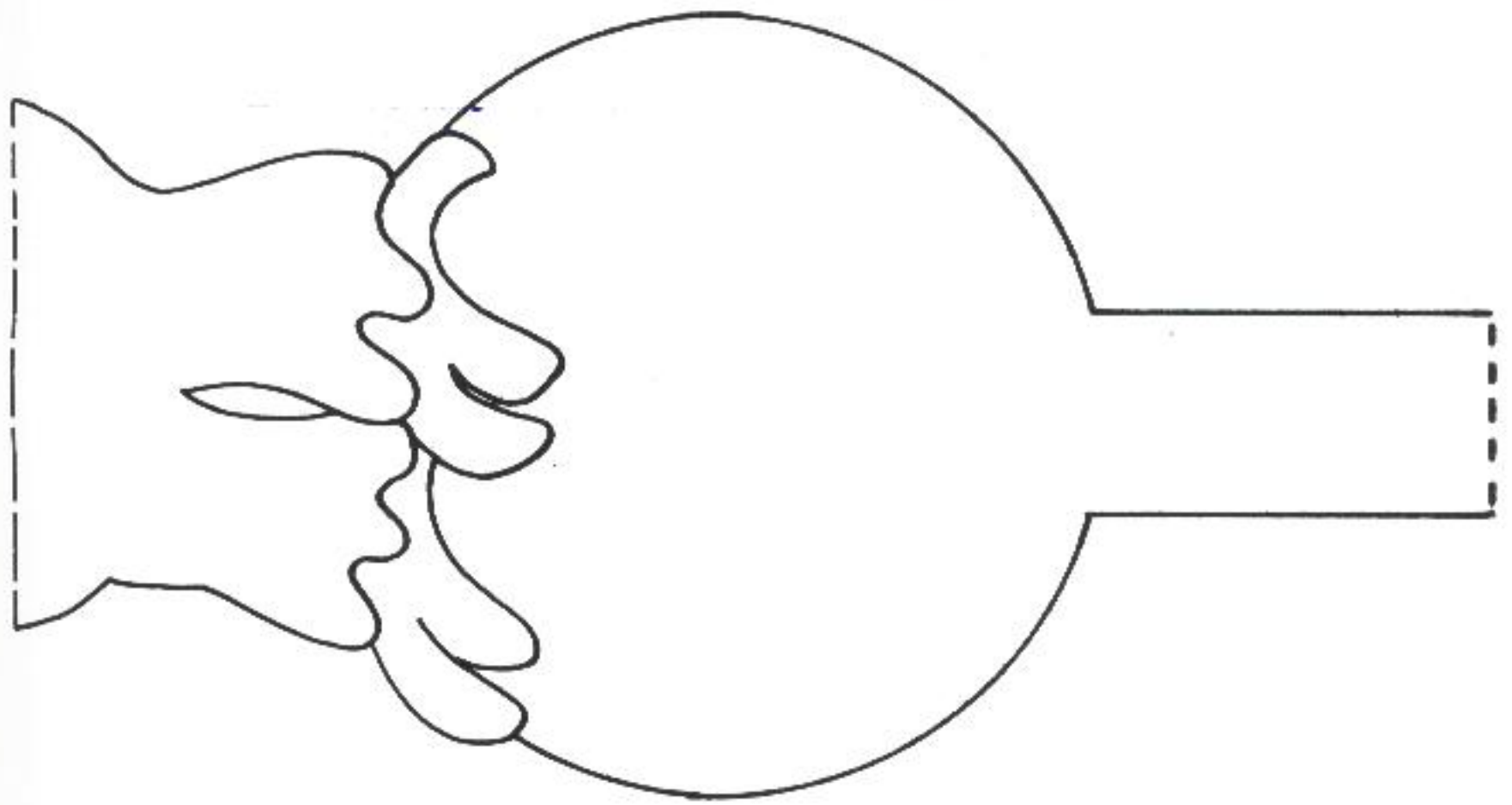
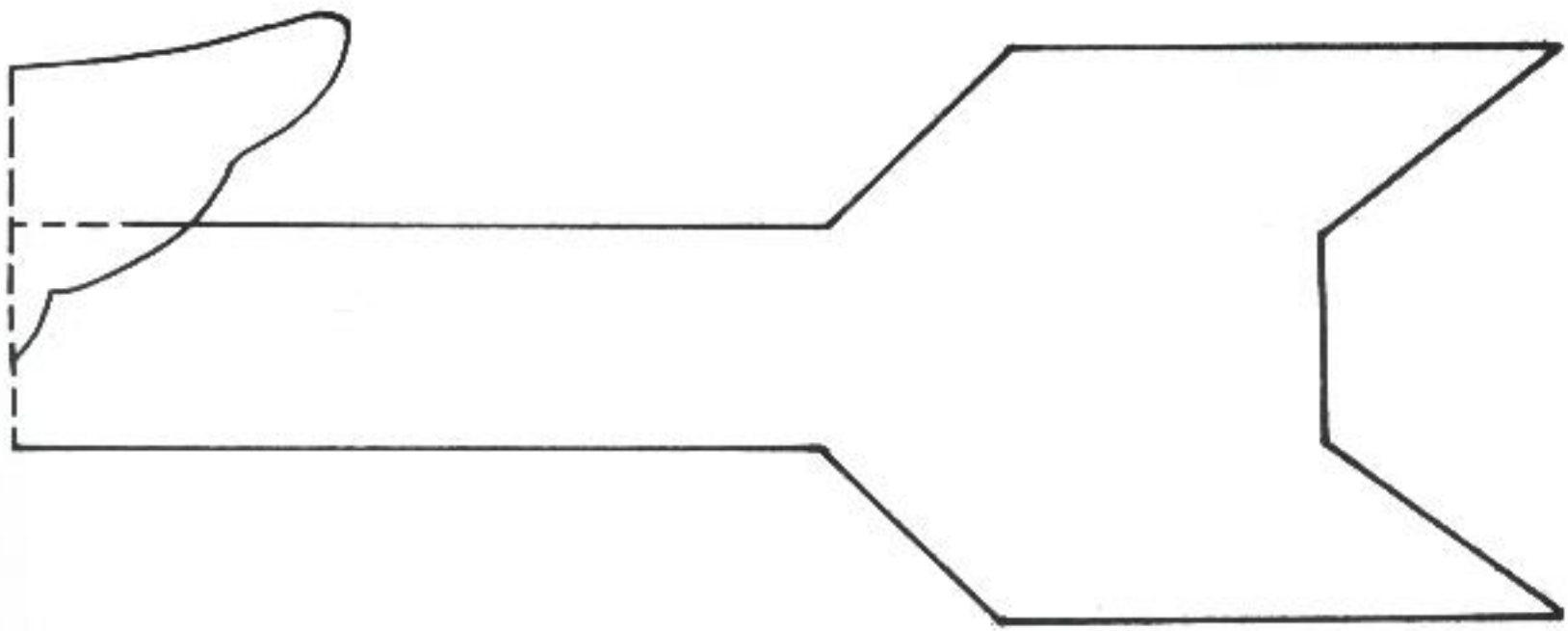

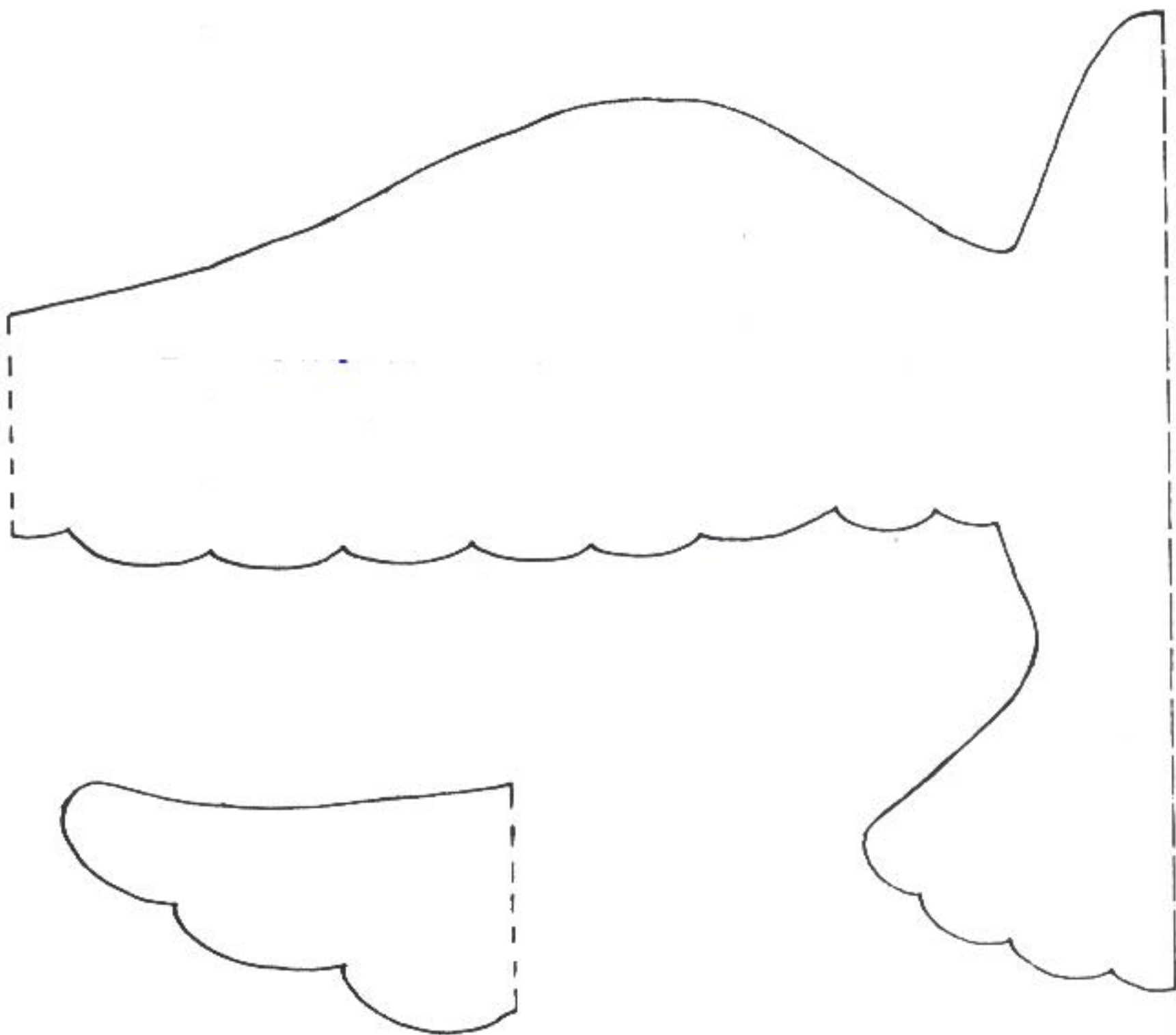

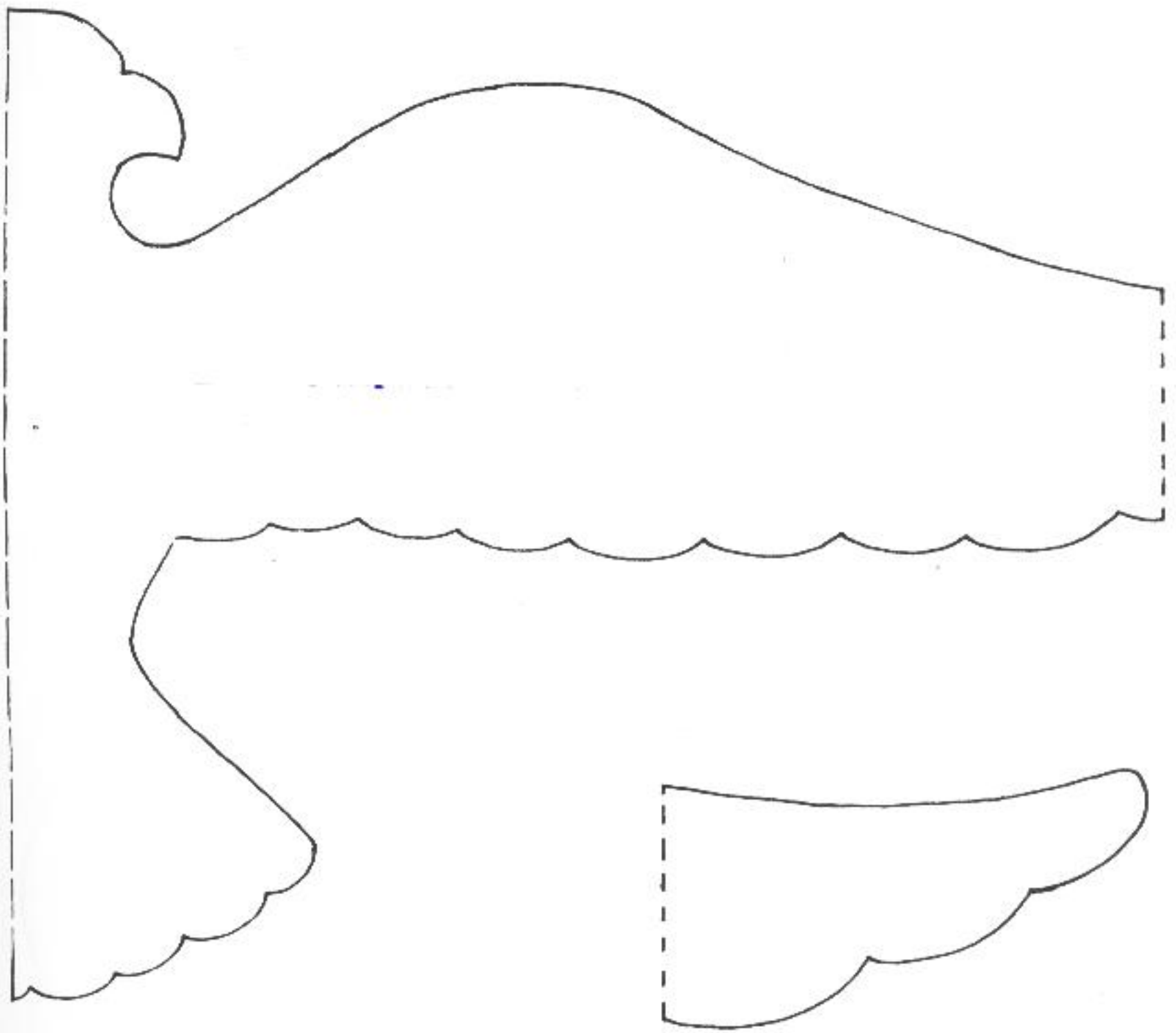

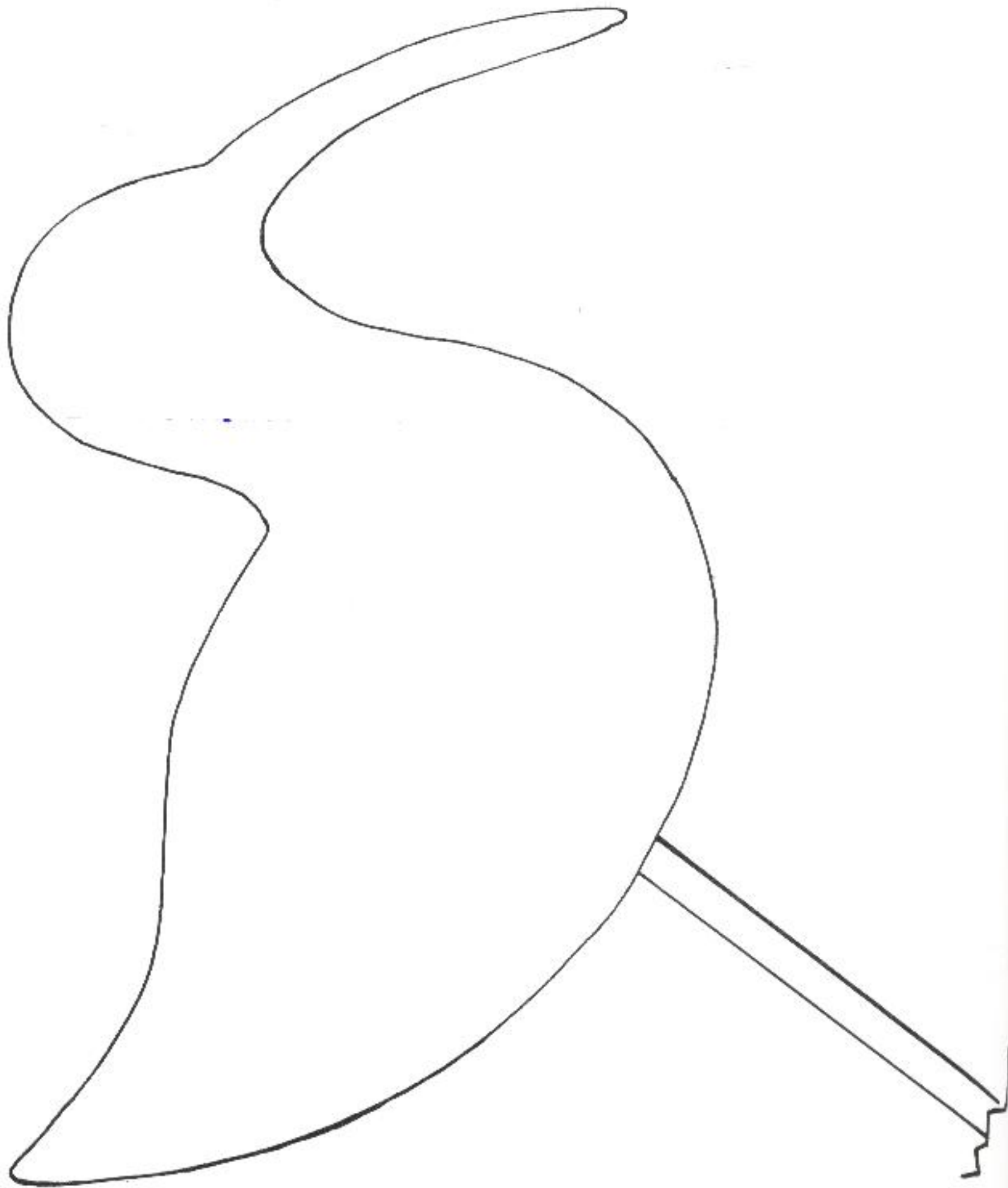

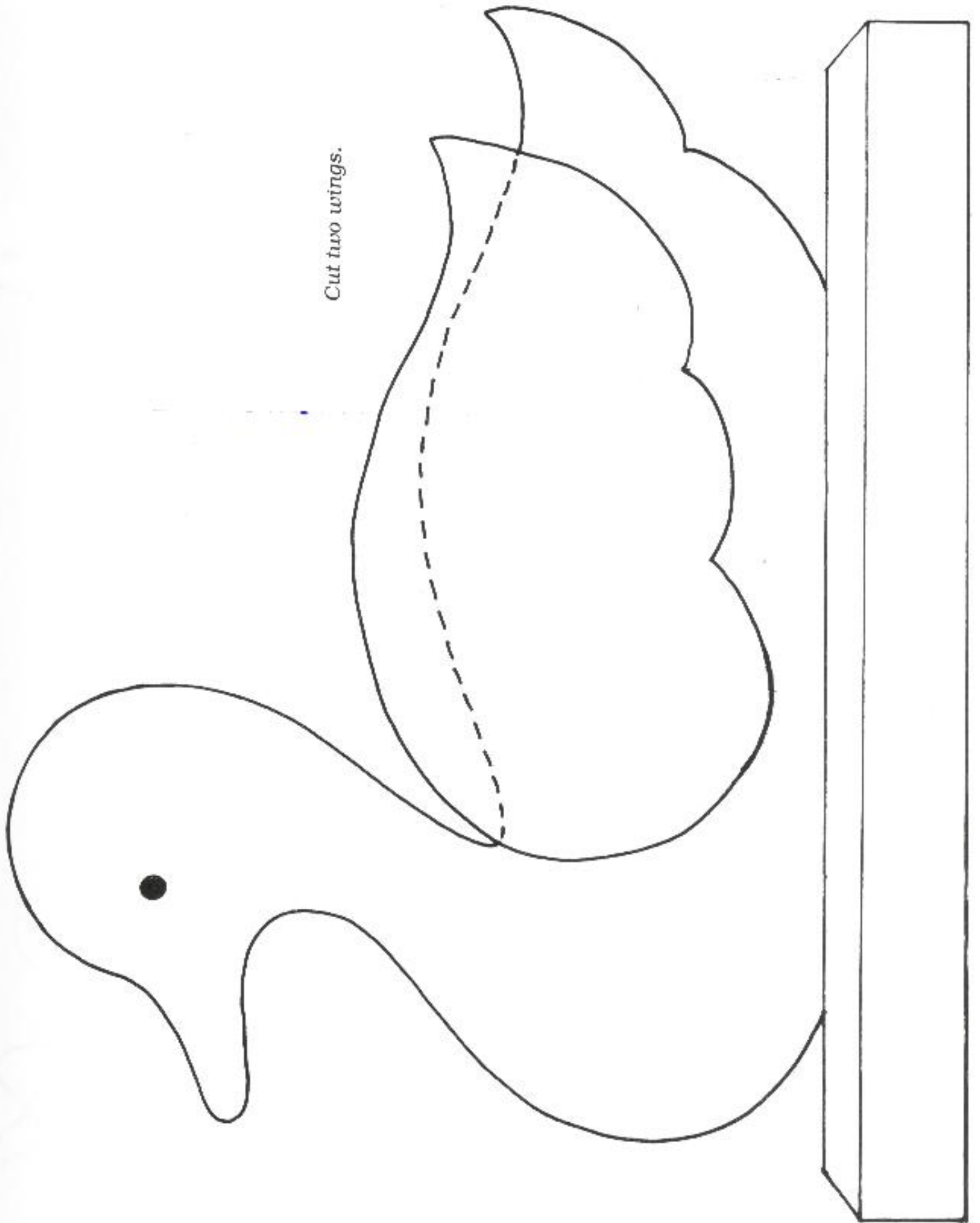

Cut two wings.

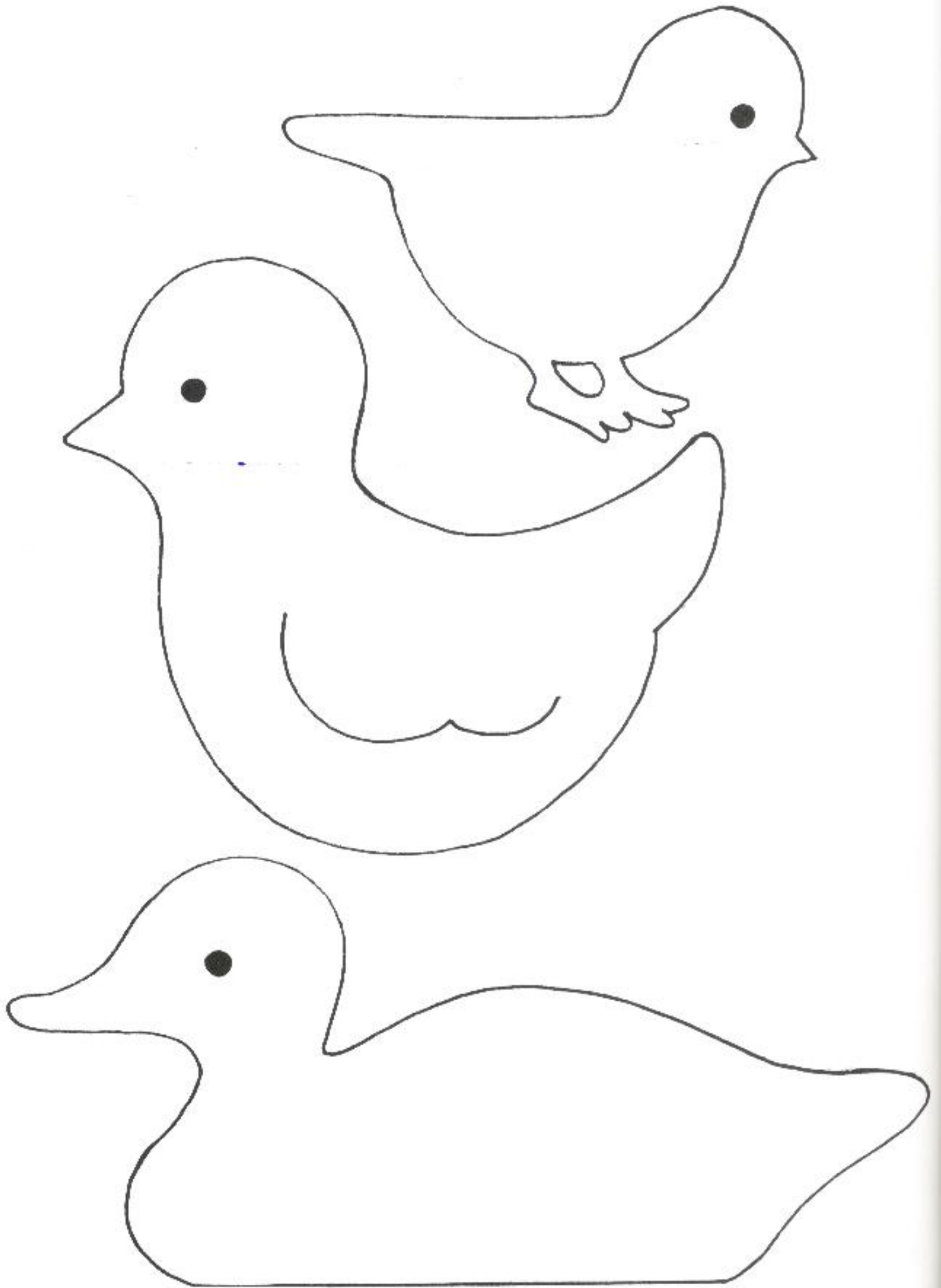



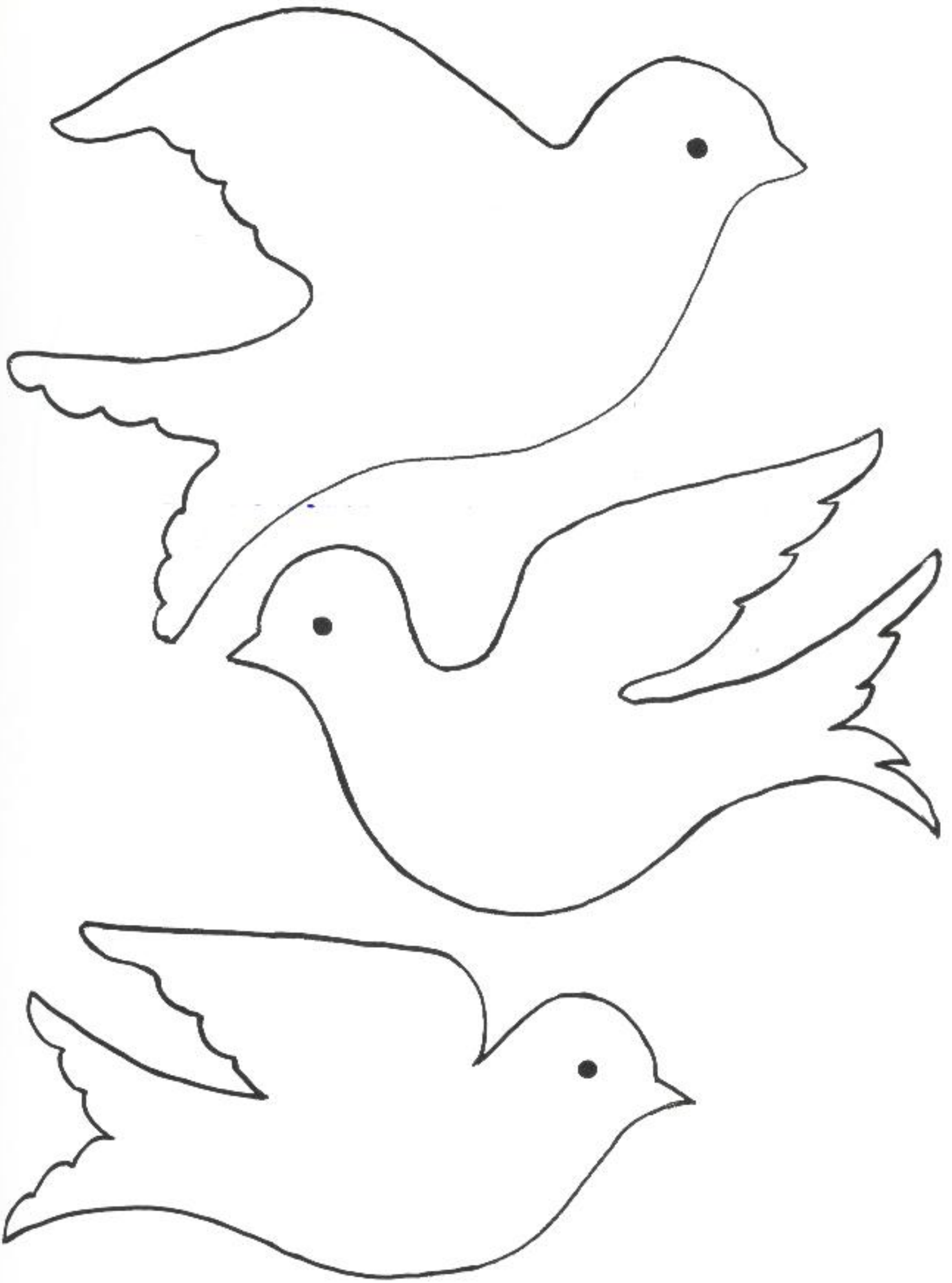

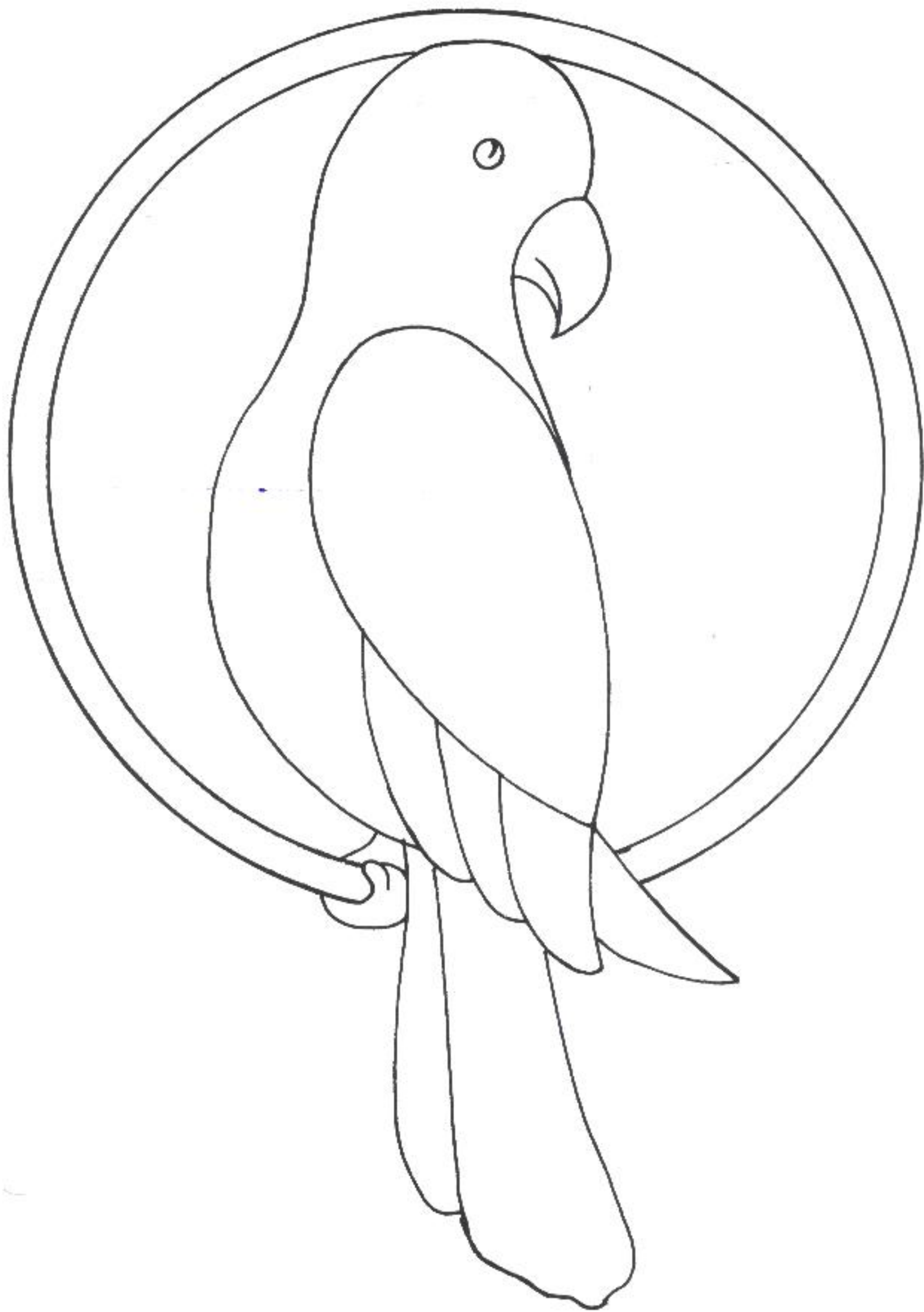

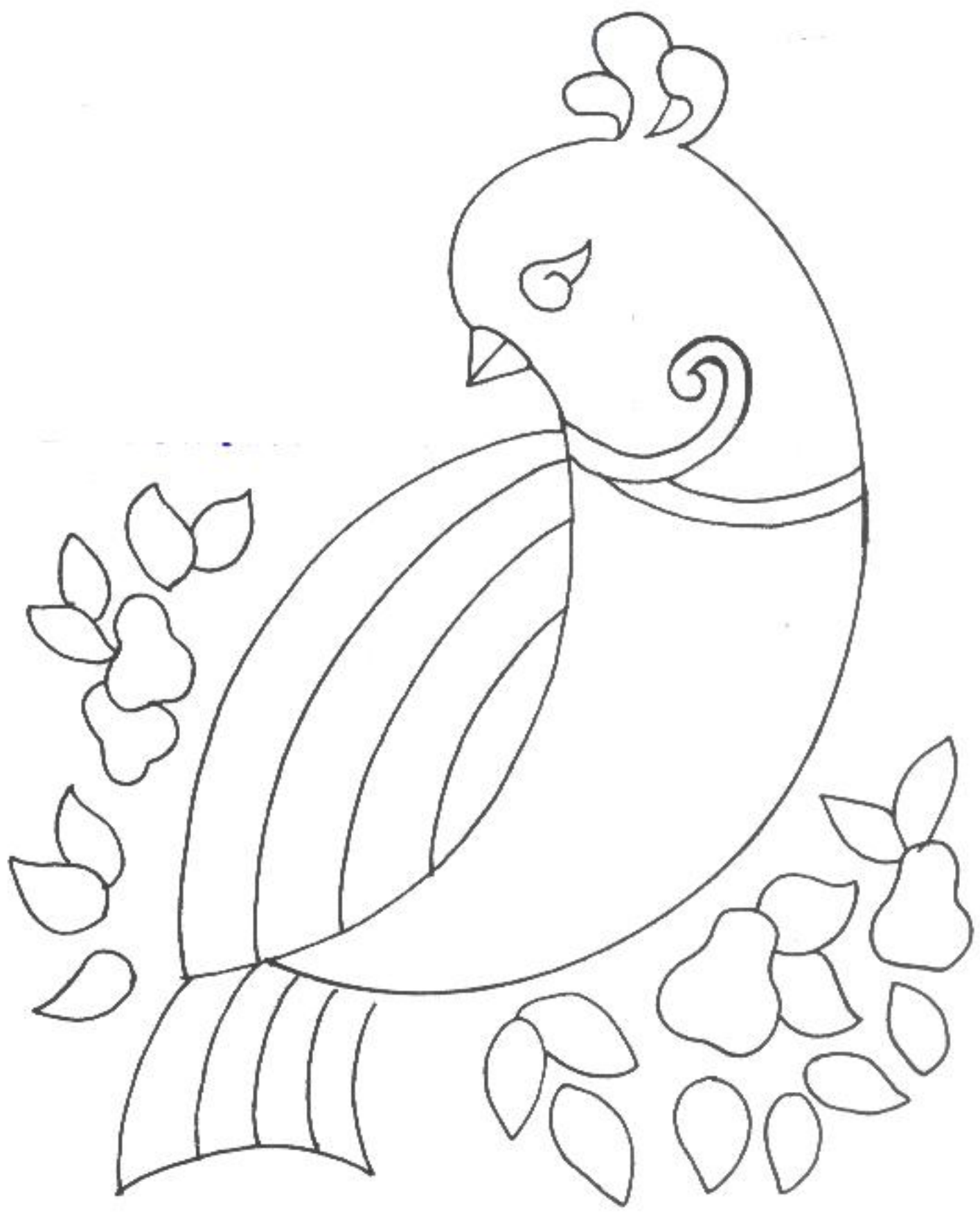



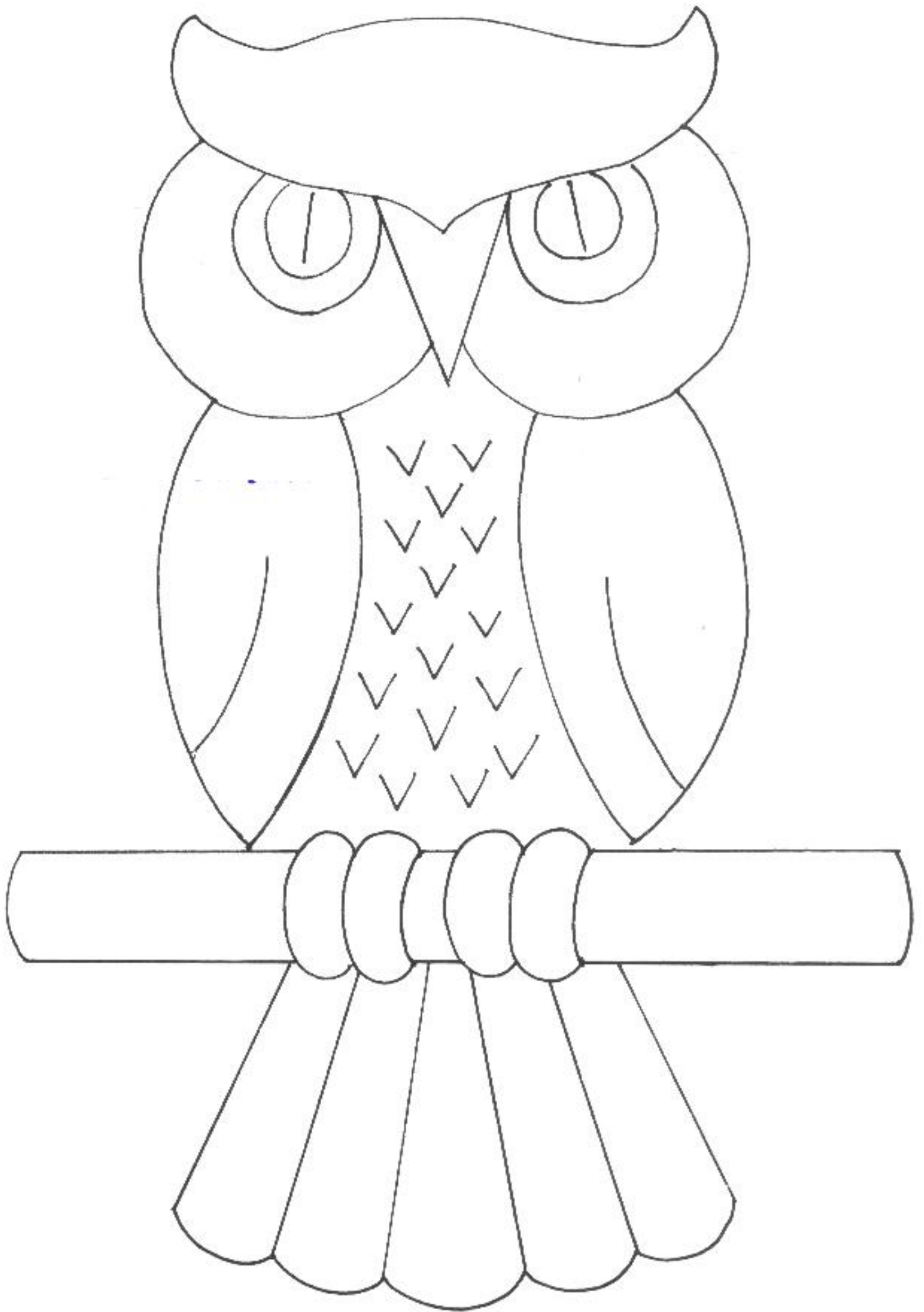



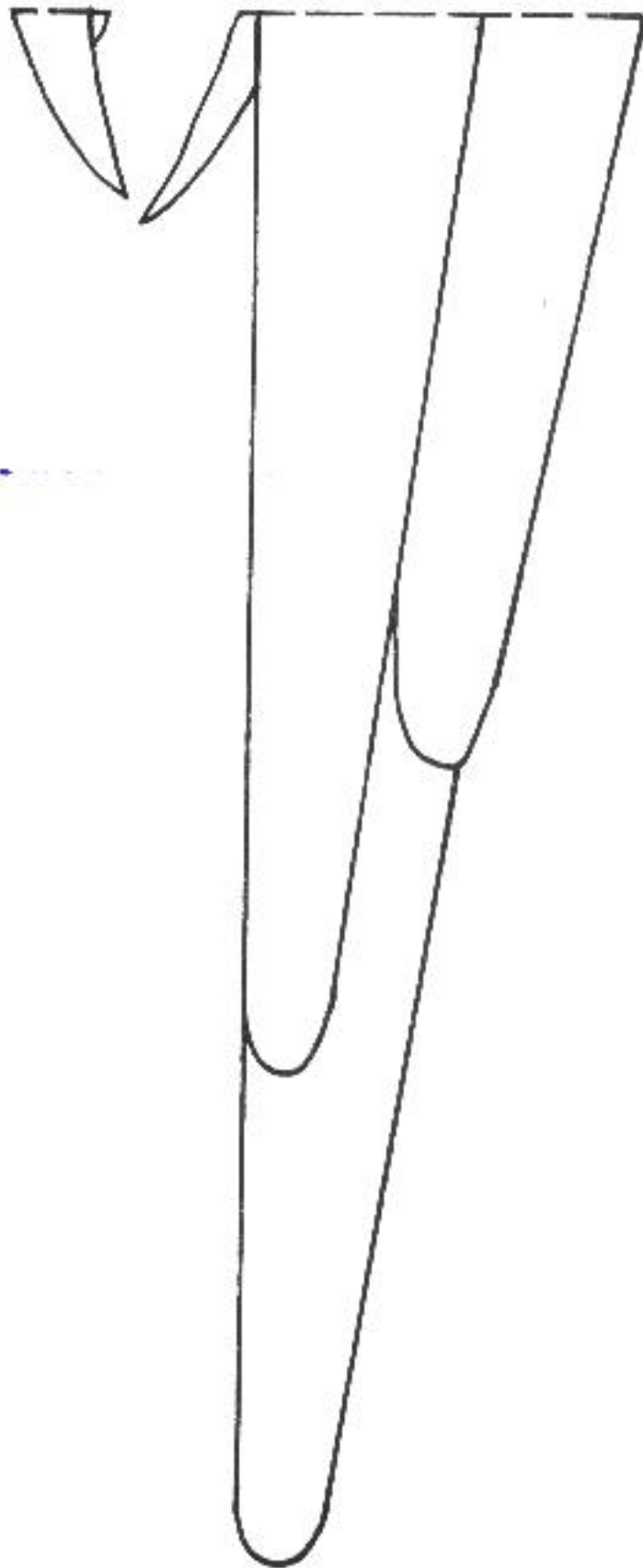

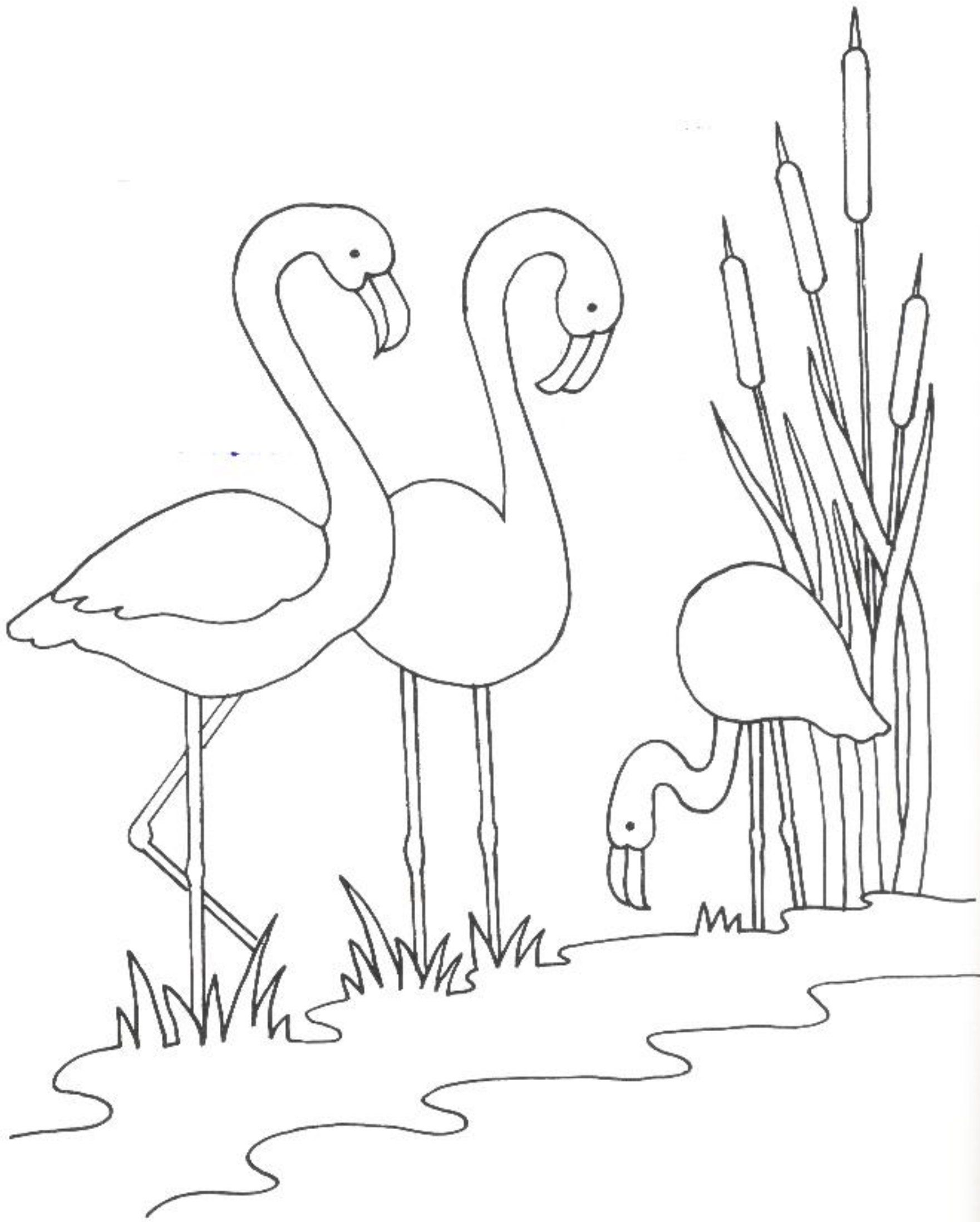





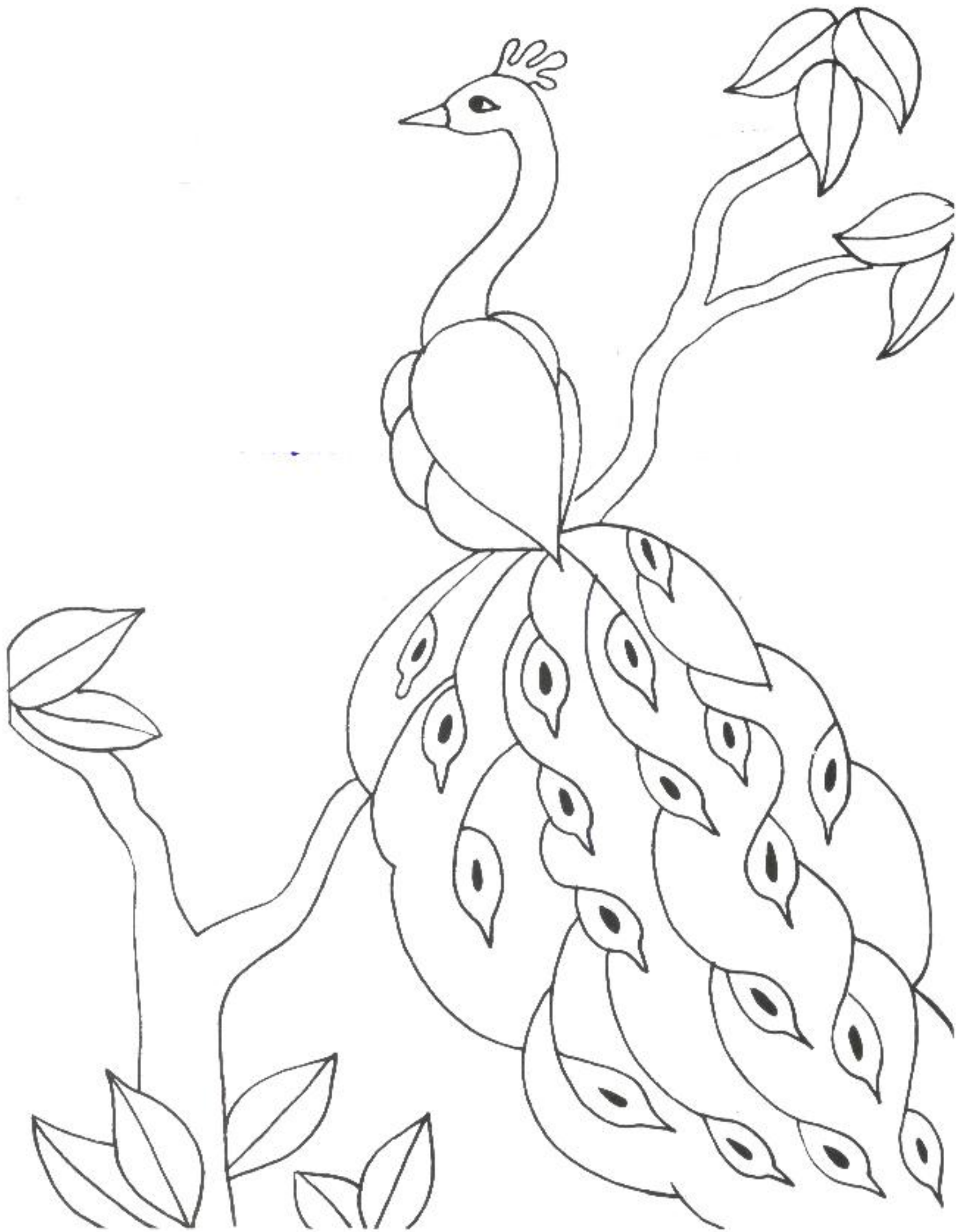

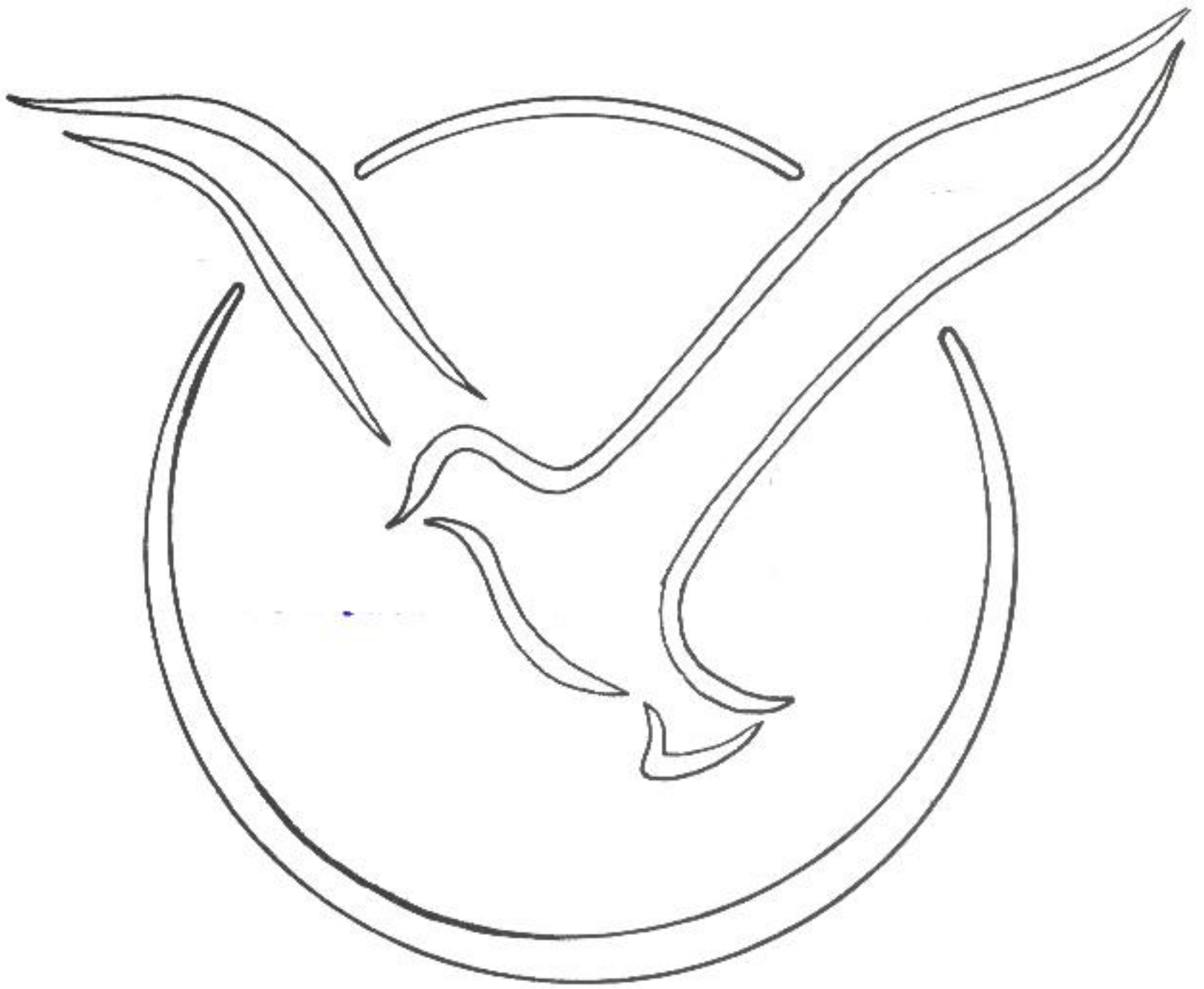

*Gull design that has been cut through. Such designs can be used for signboards or clockfaces.*

# Key Racks

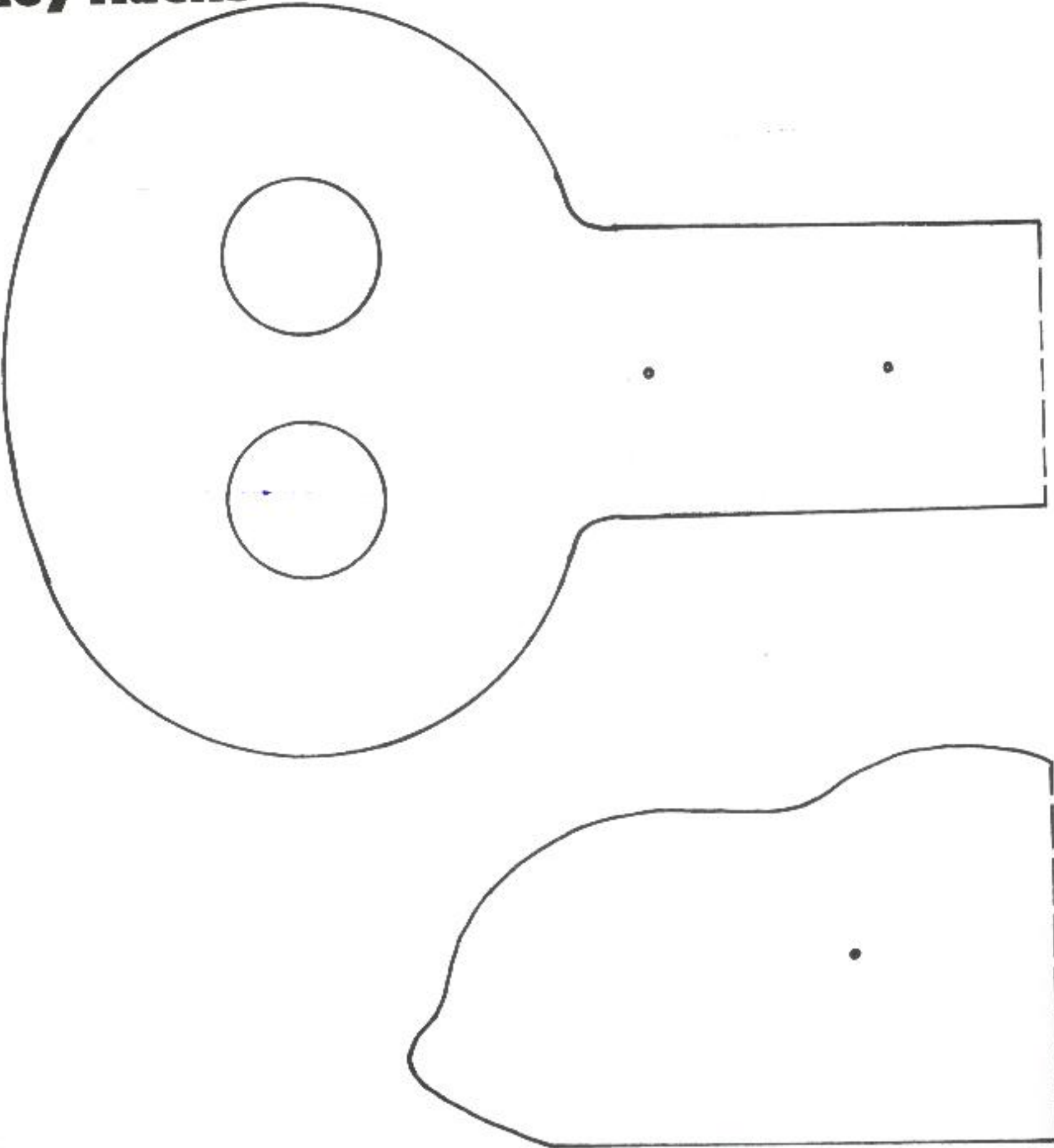

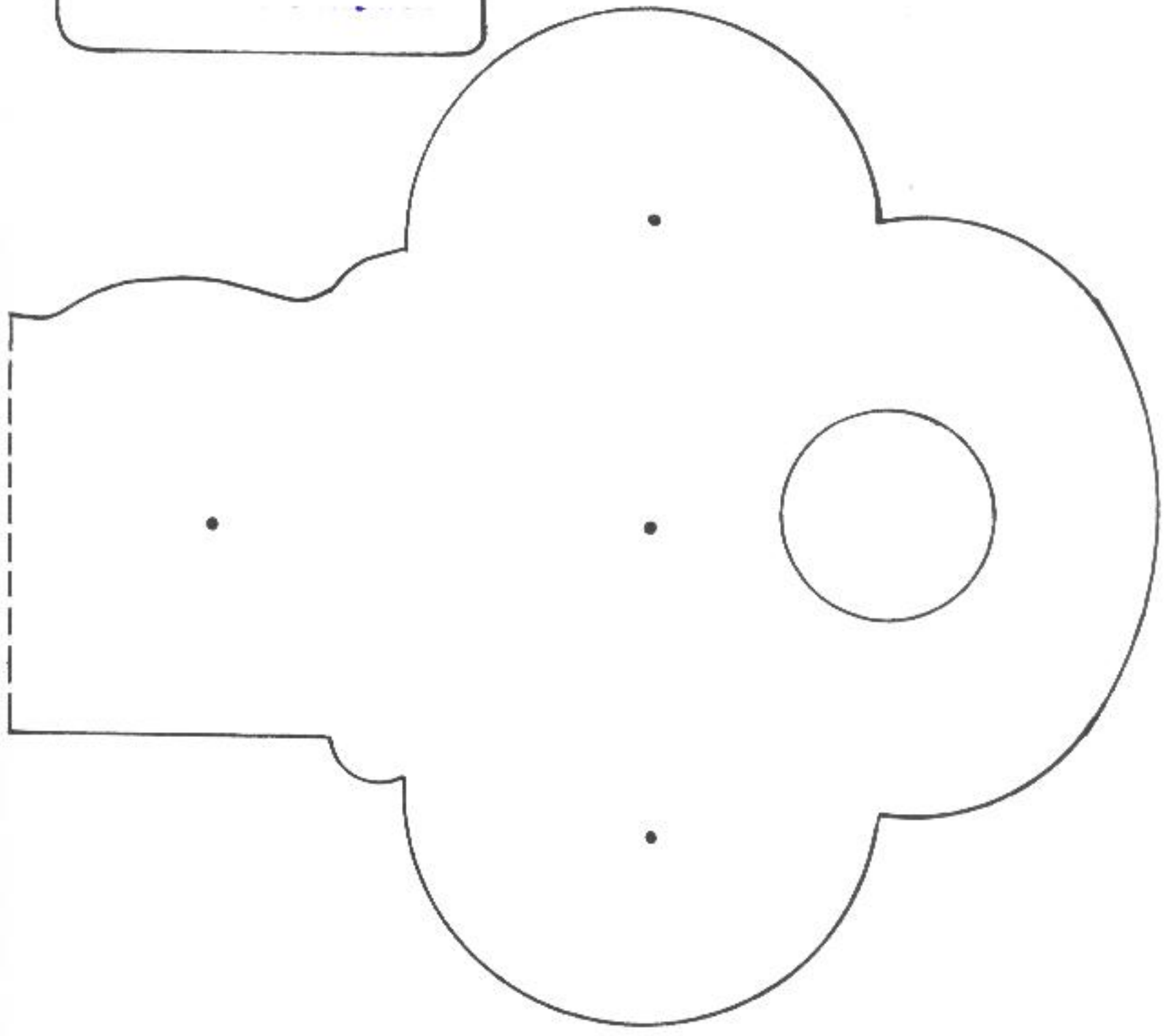
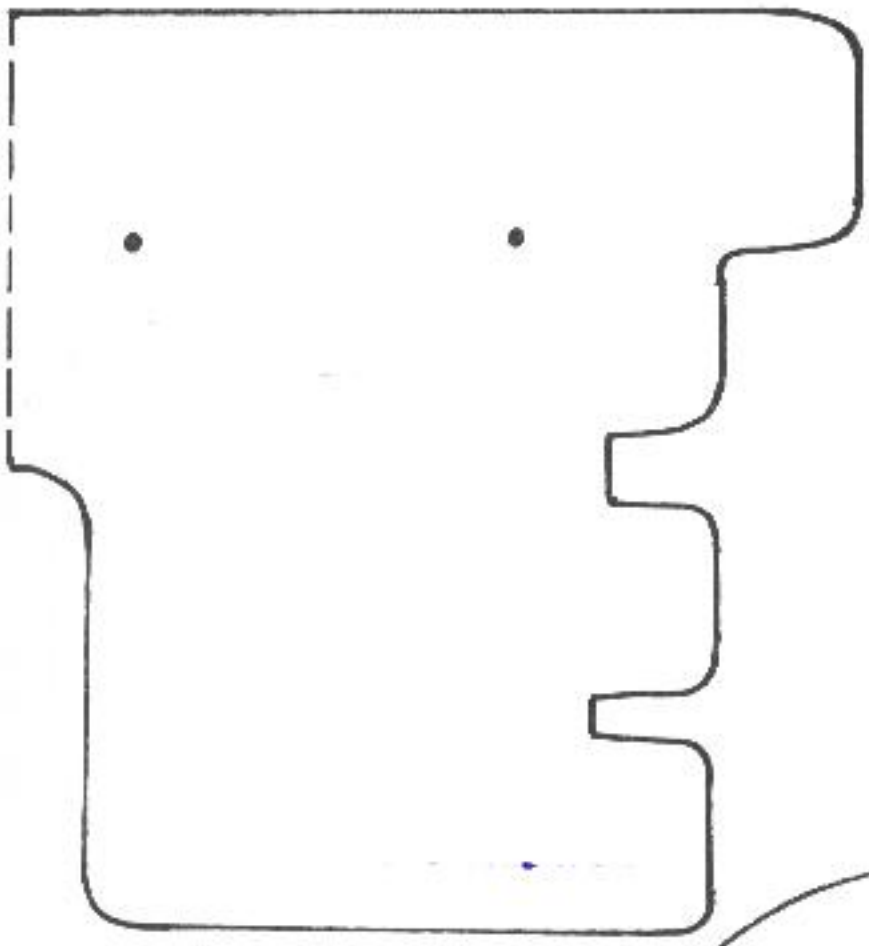

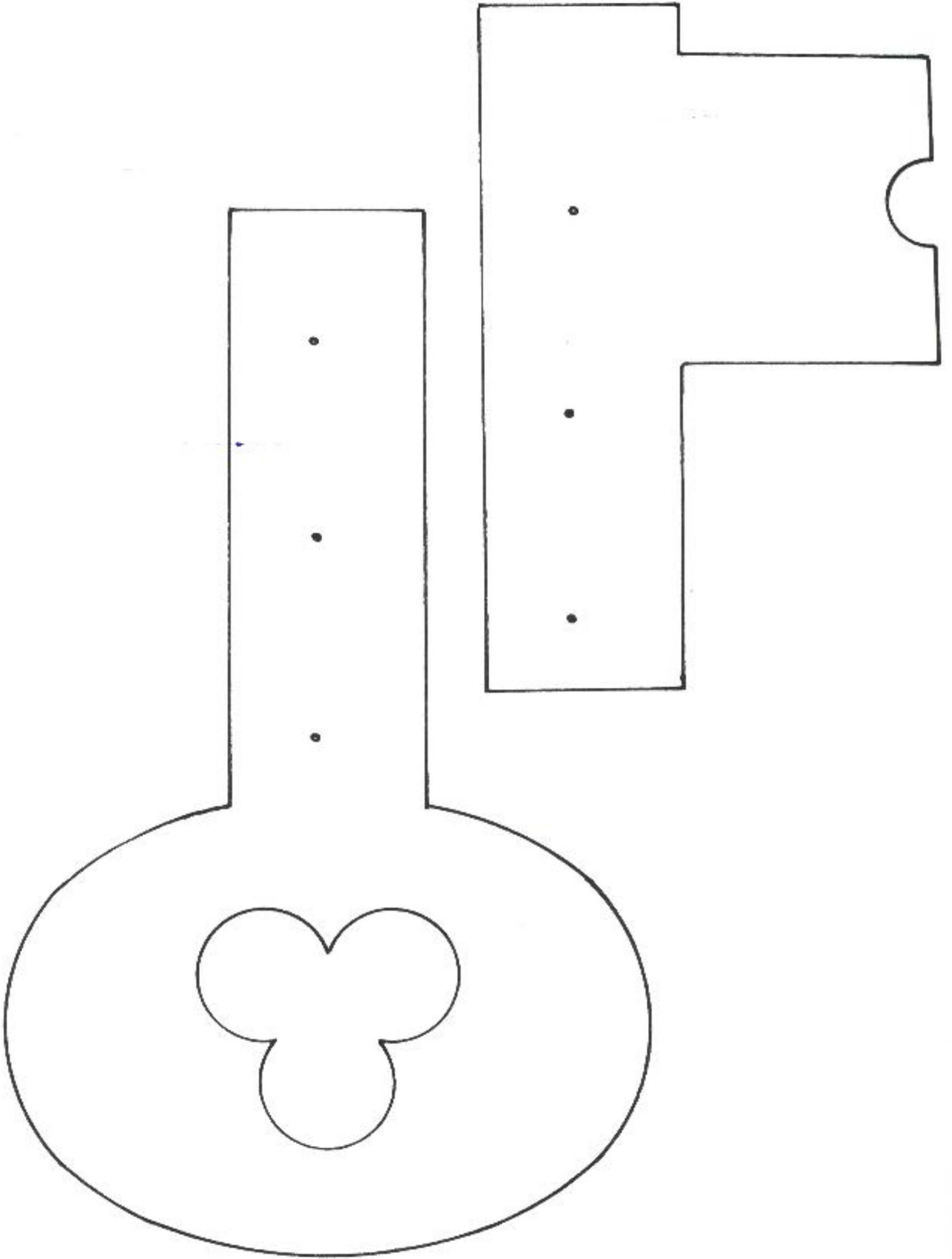

# Interlocking Trees/Corner Shelves



*Interlocking trees cut from 1/4-inch plywood.*

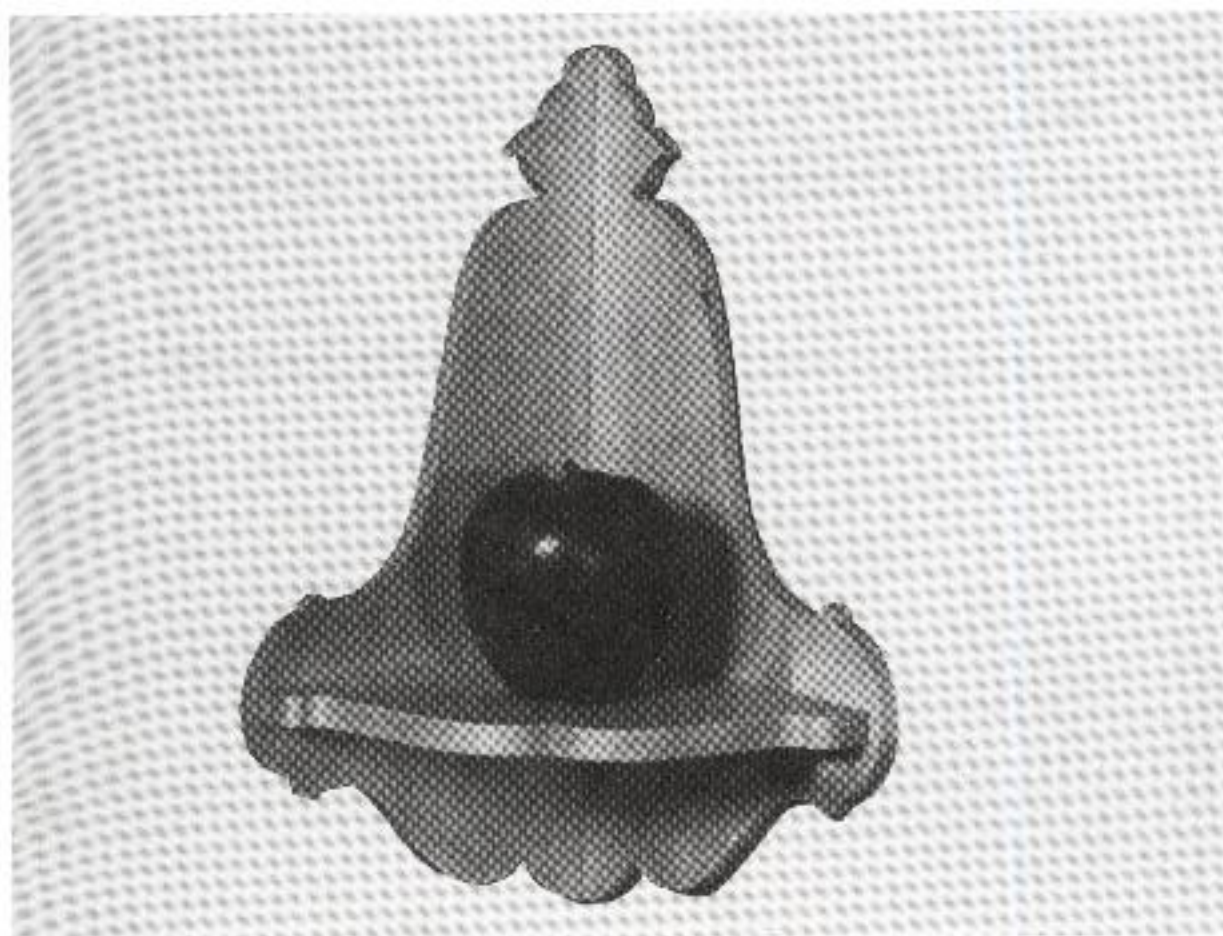

*Corner shelf with 1/4-inch-thick sides; the shelf is 3/8 inch thick.*

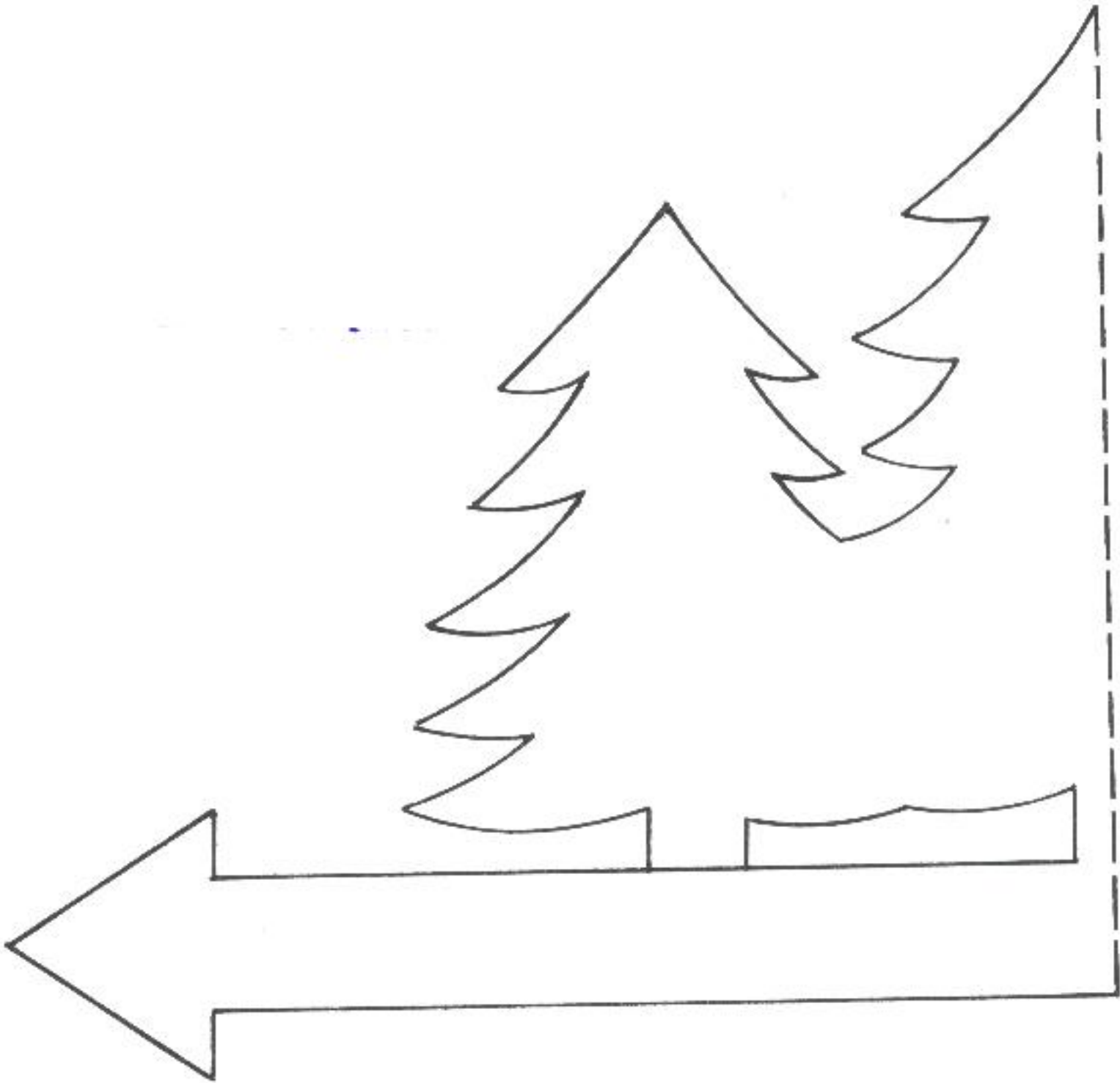



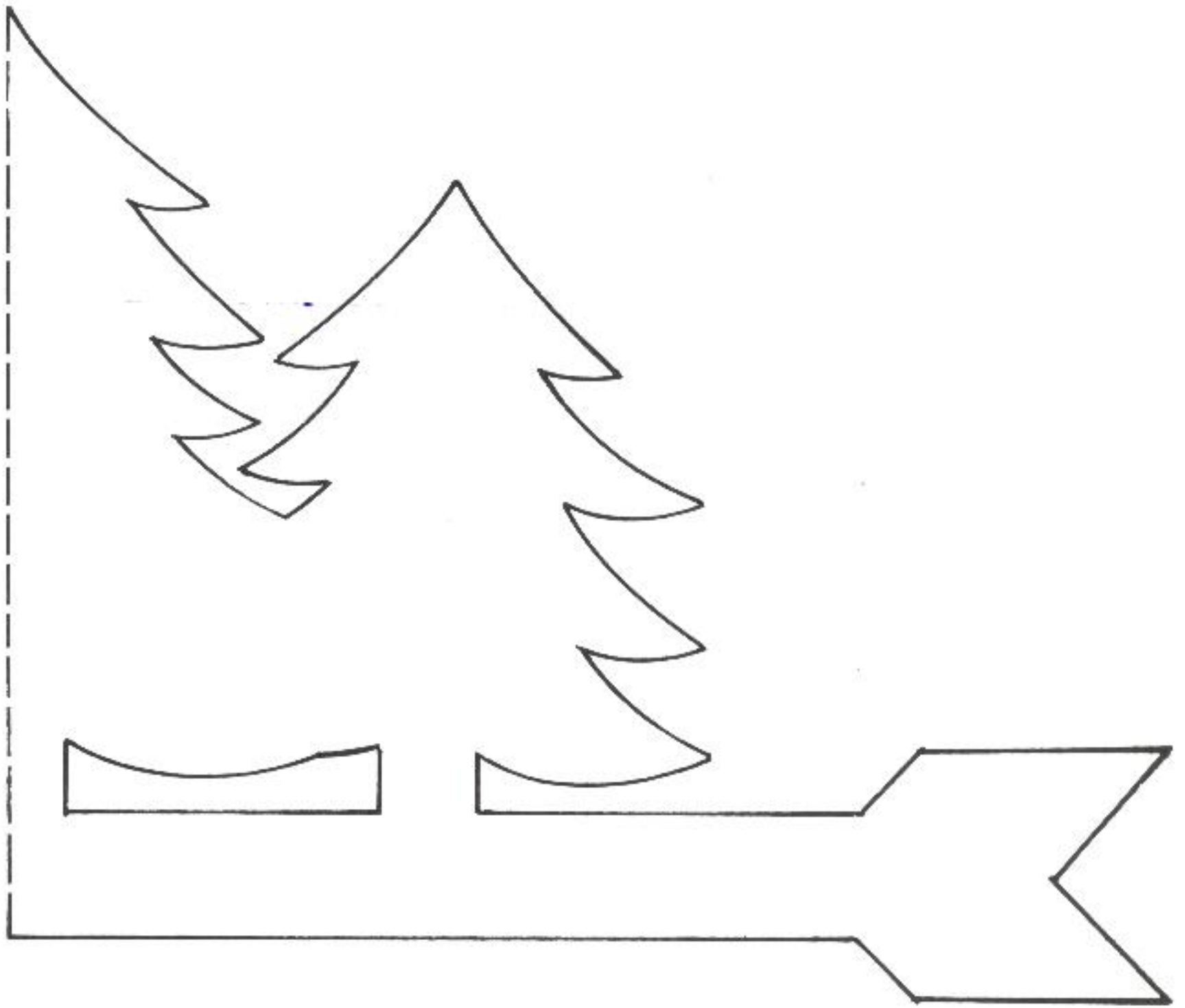

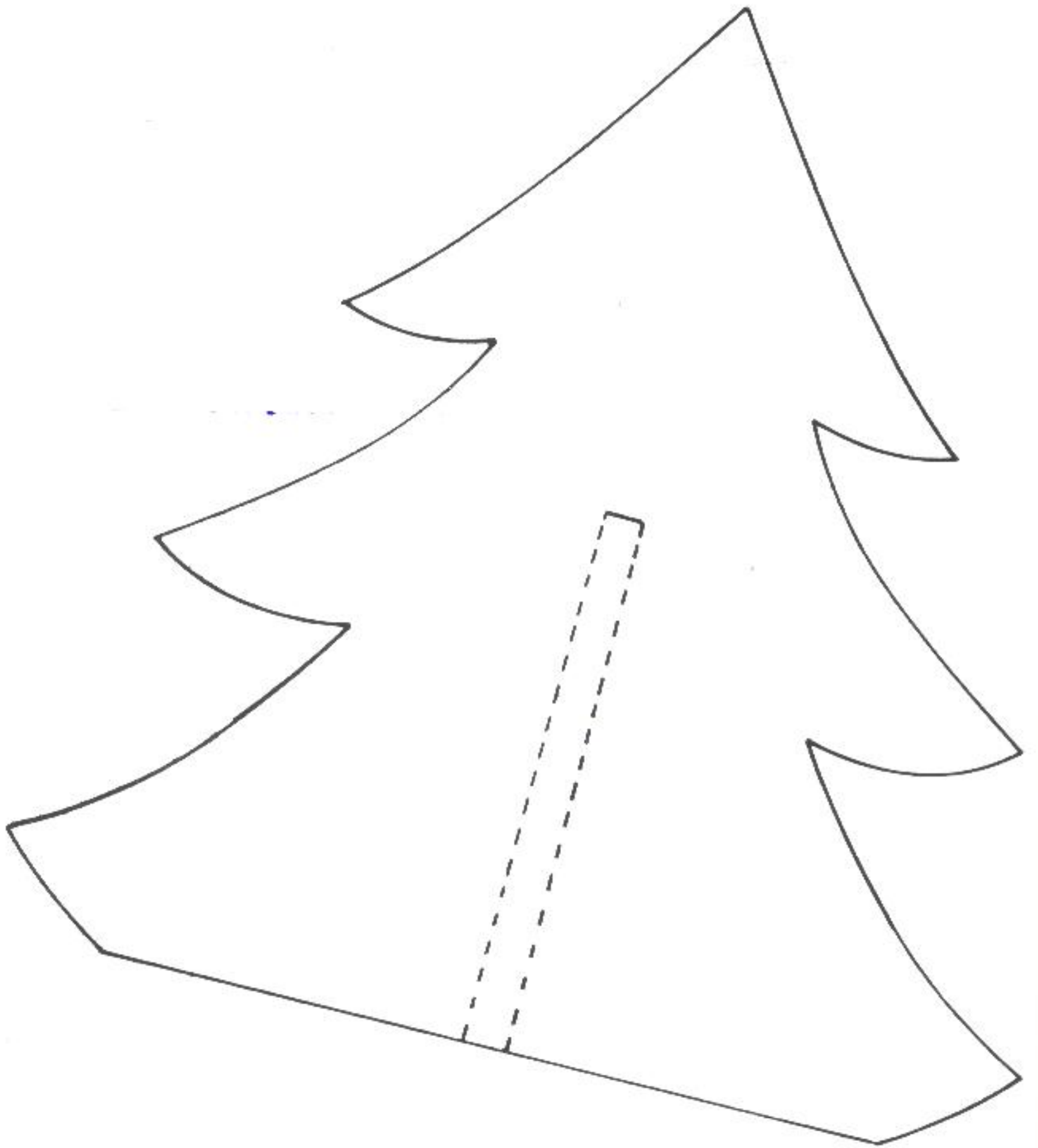



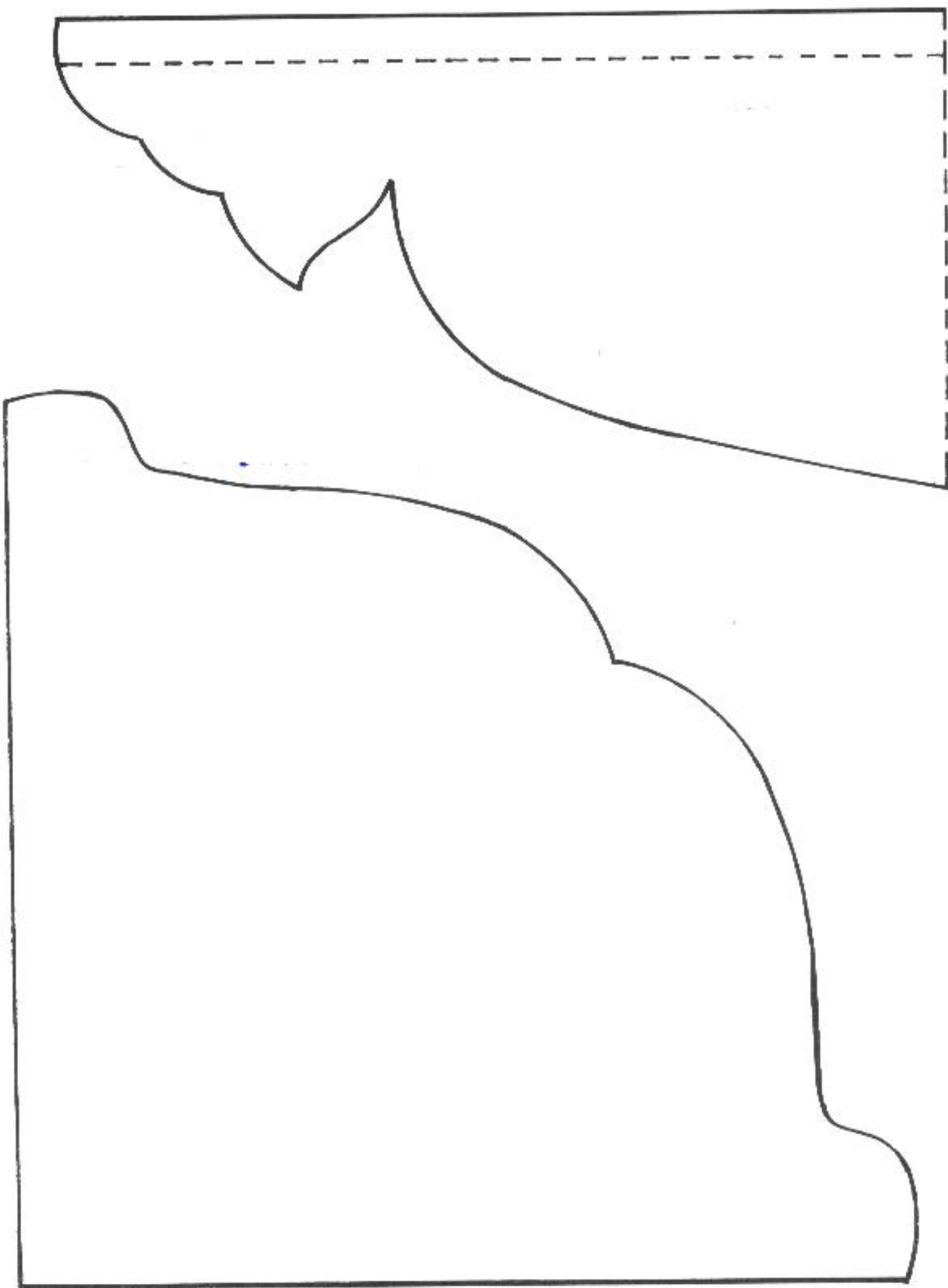

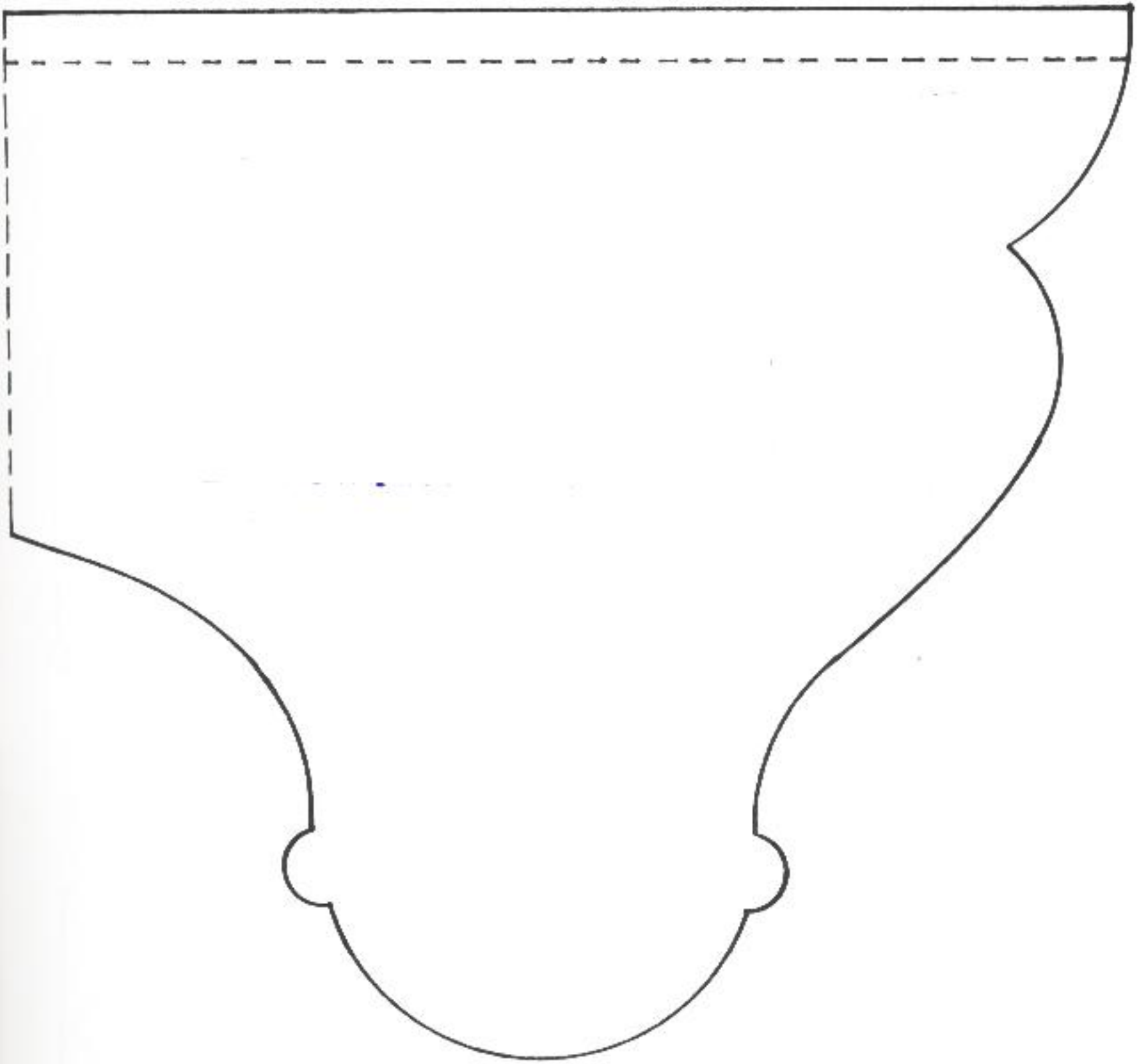

# Man's Best Friends

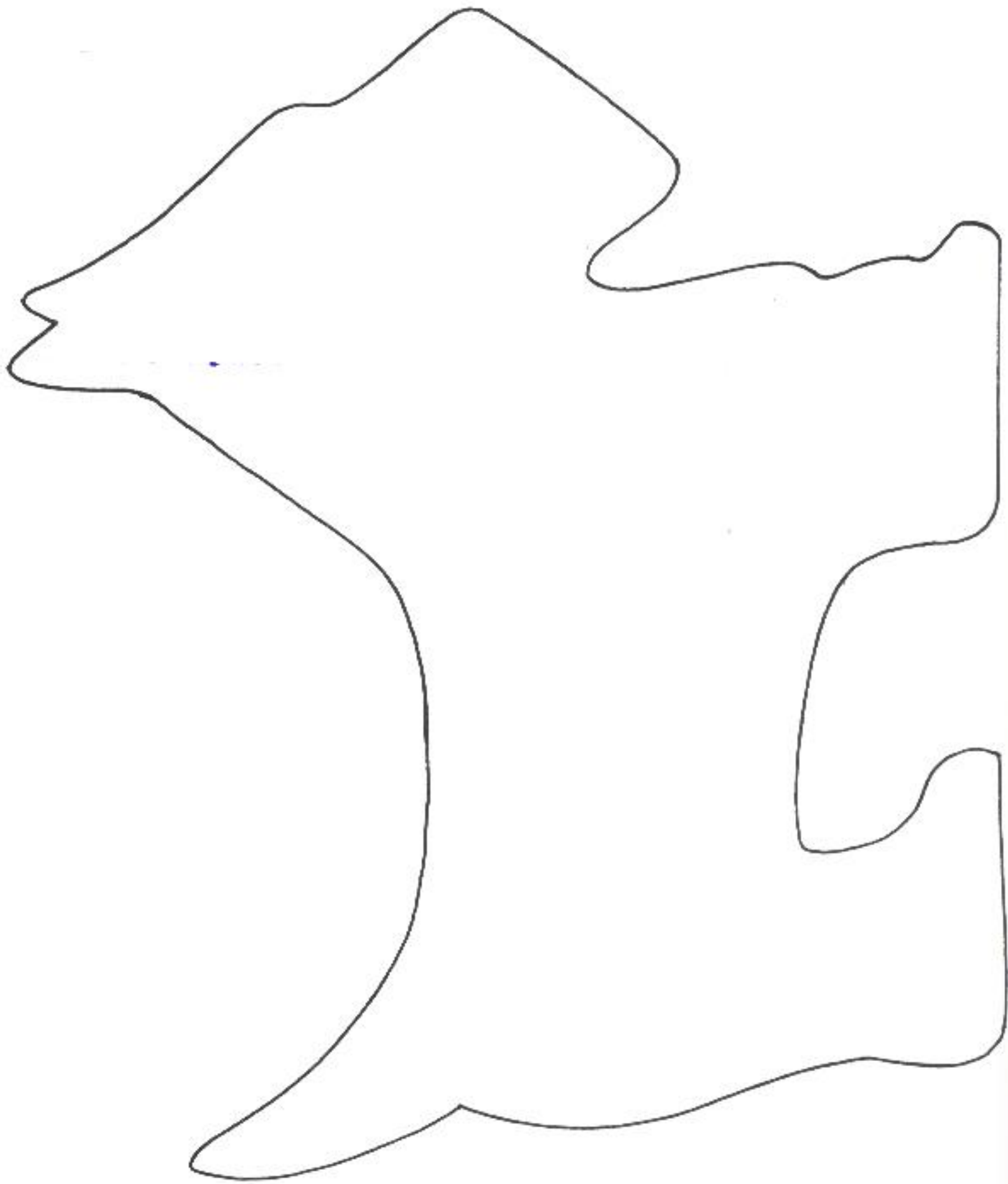

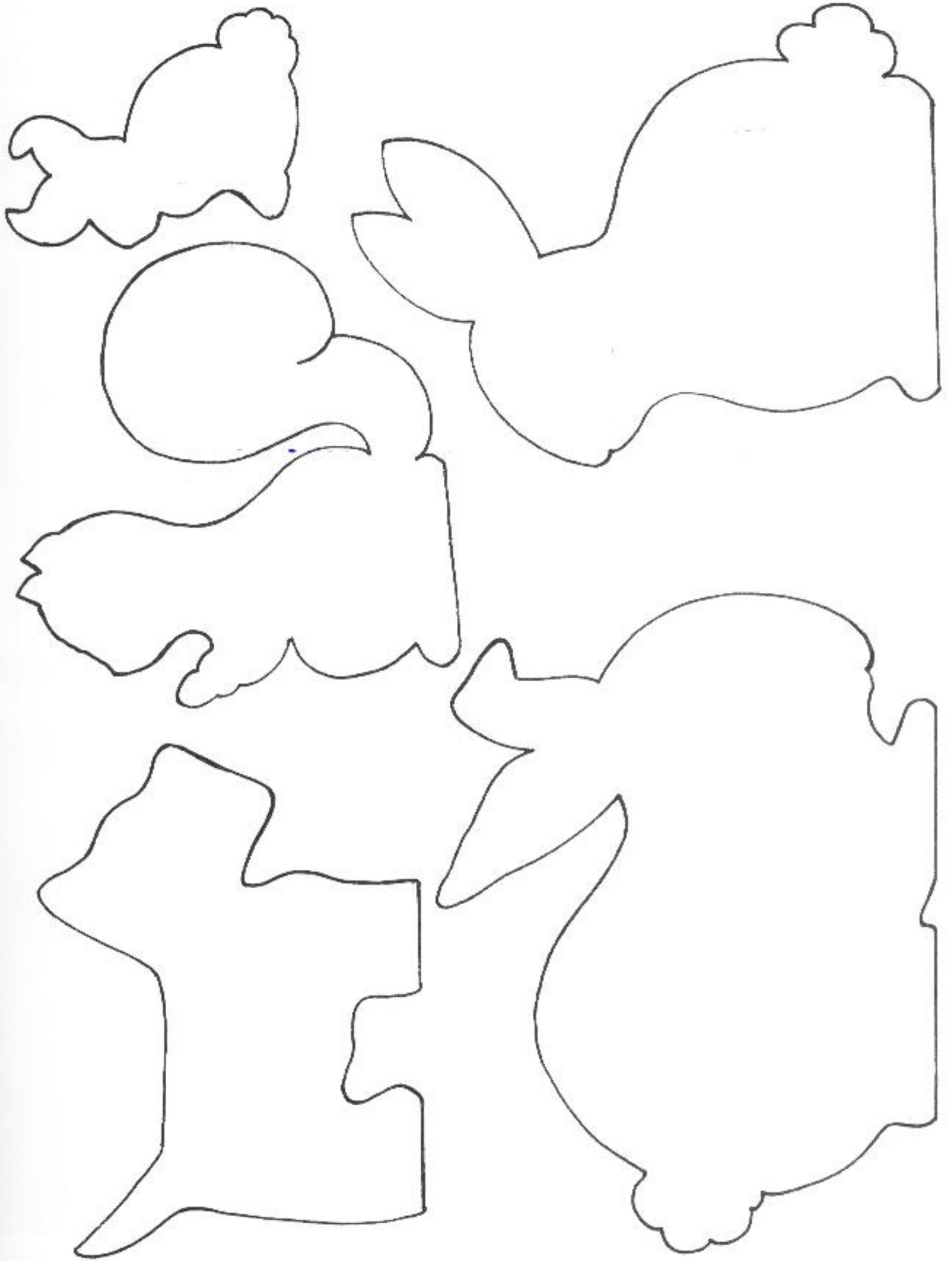

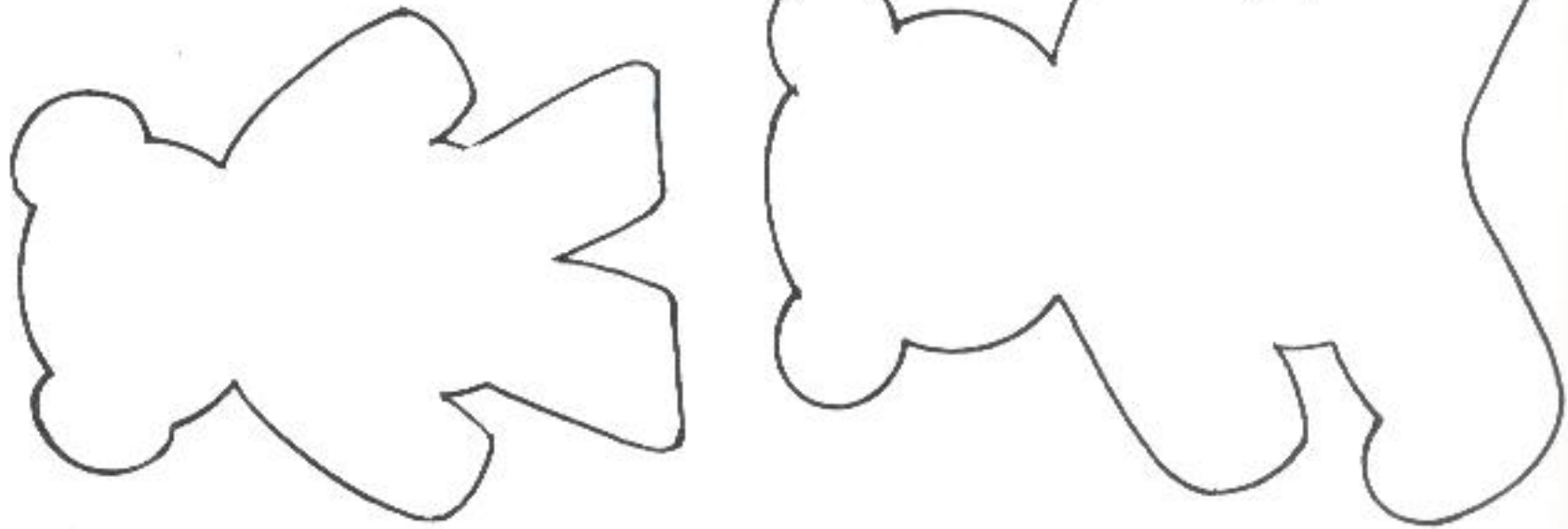
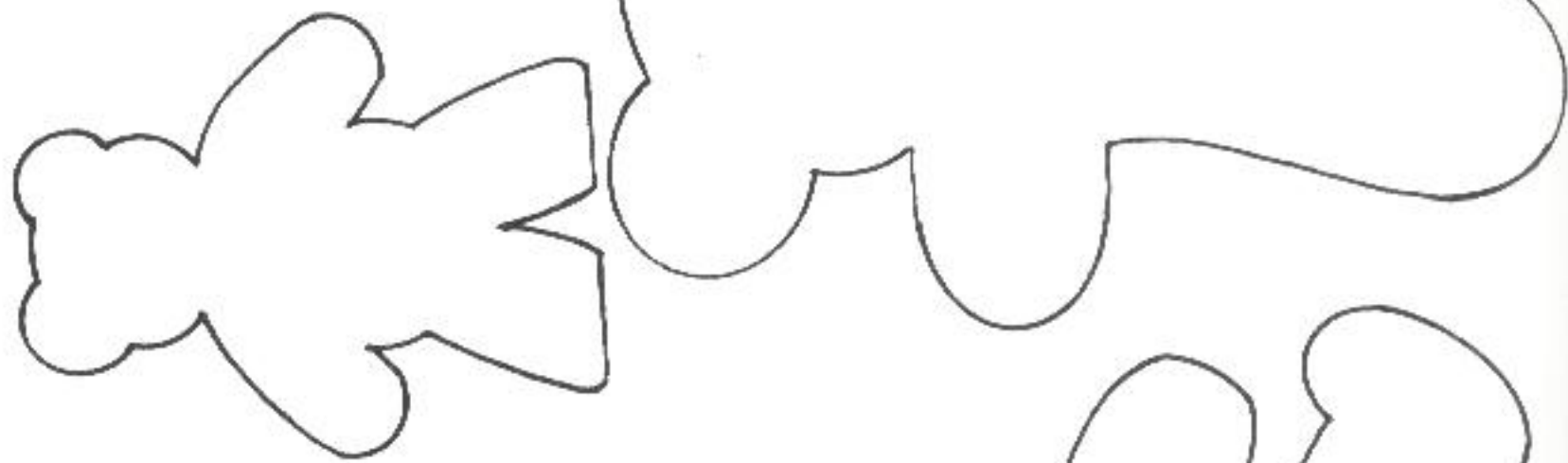
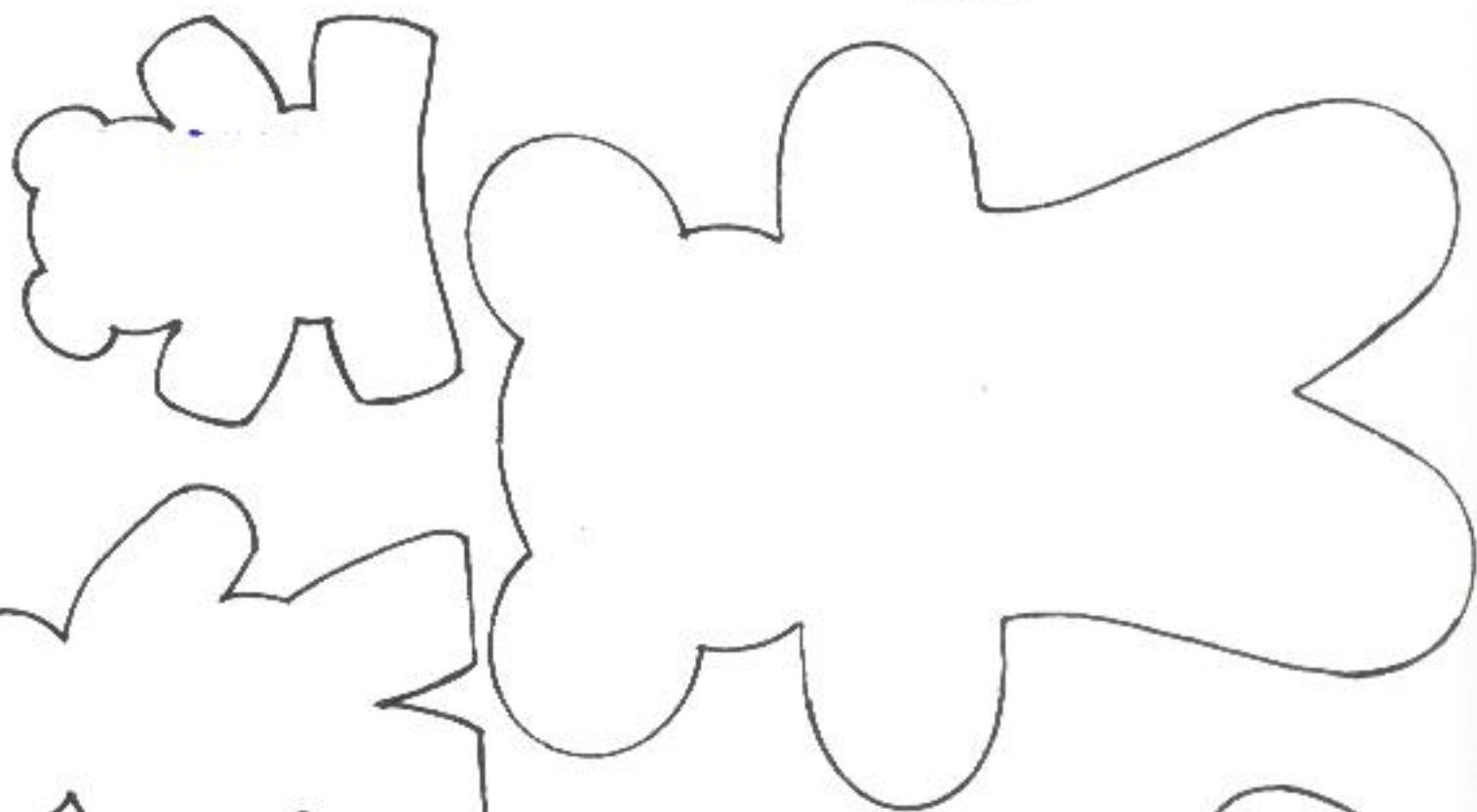
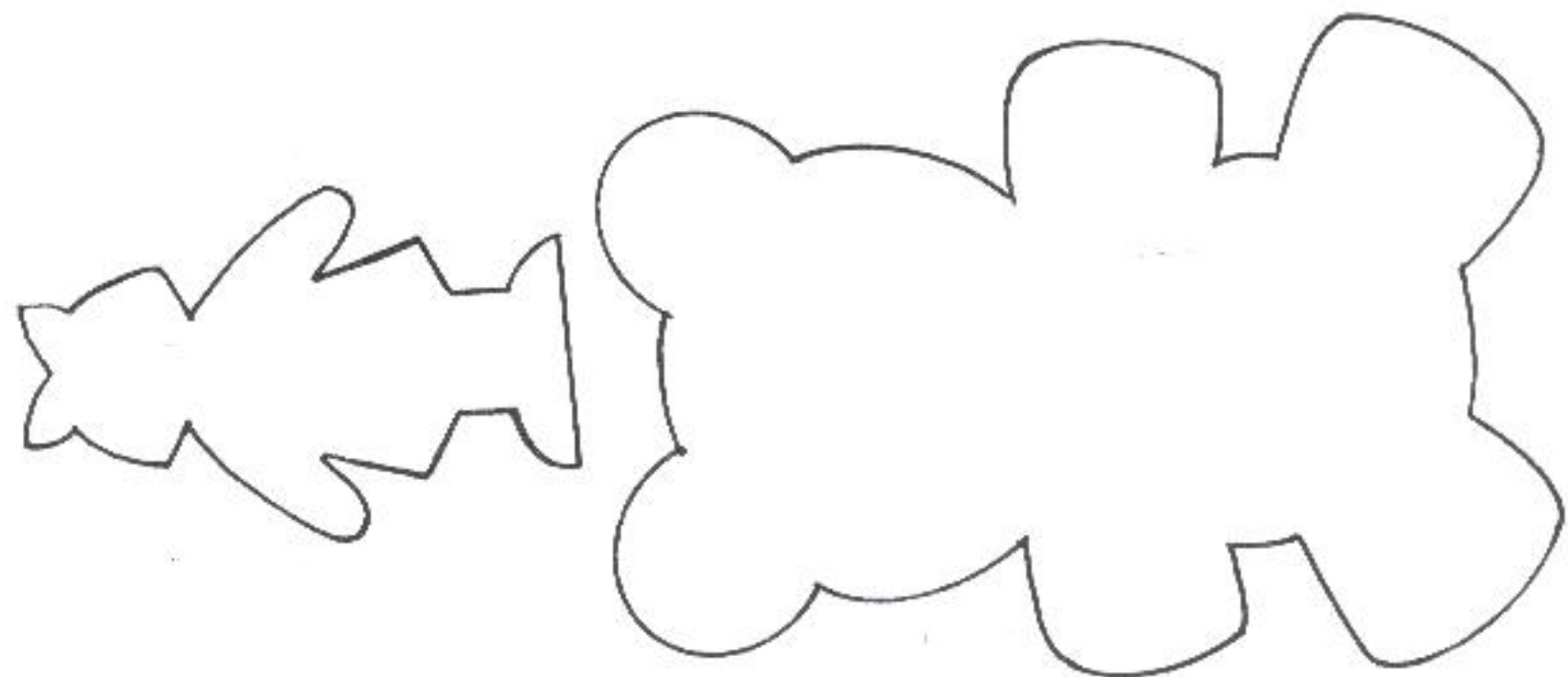



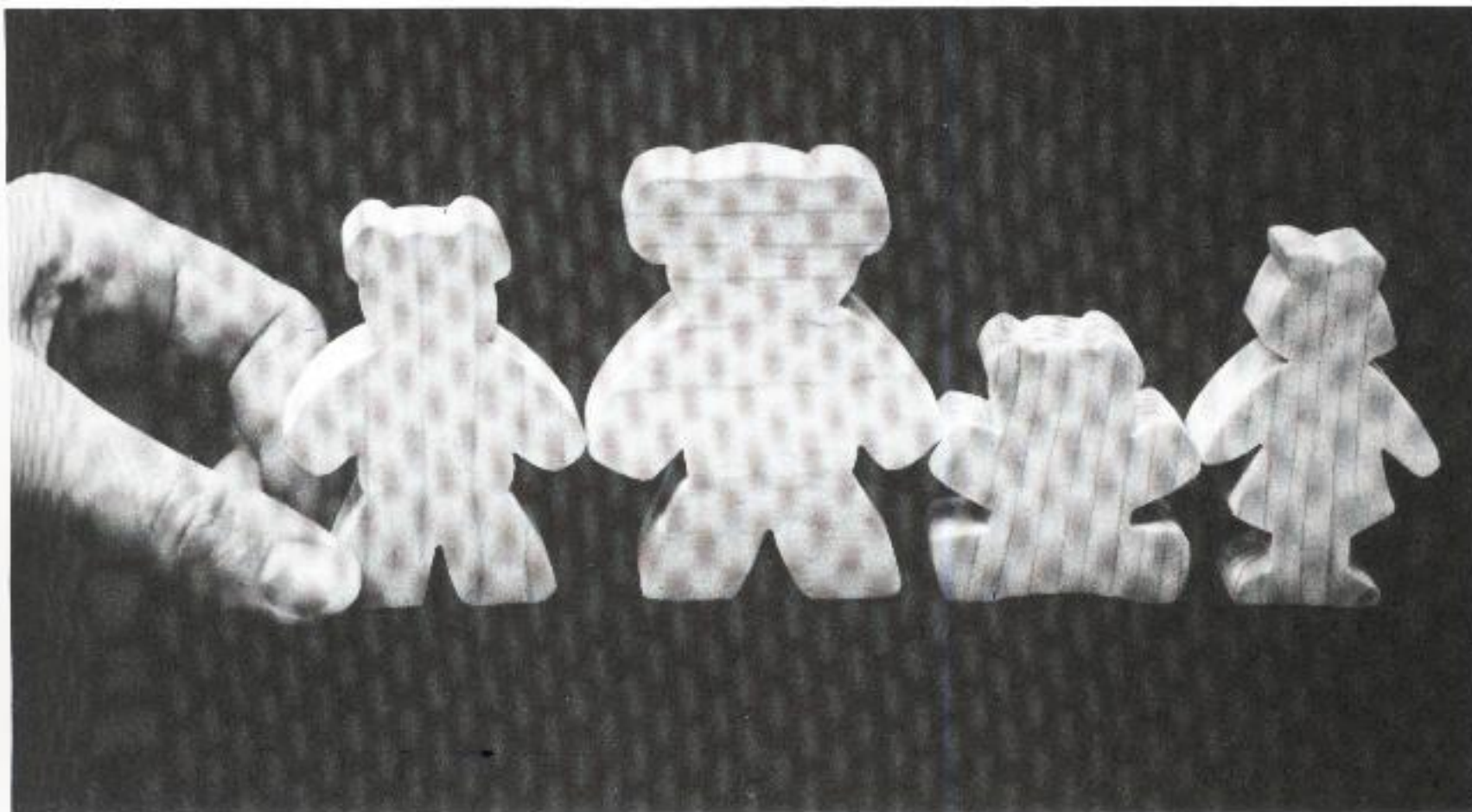

*Goldilocks and the Three Bears.*

## **Mini-Animal Cutouts**

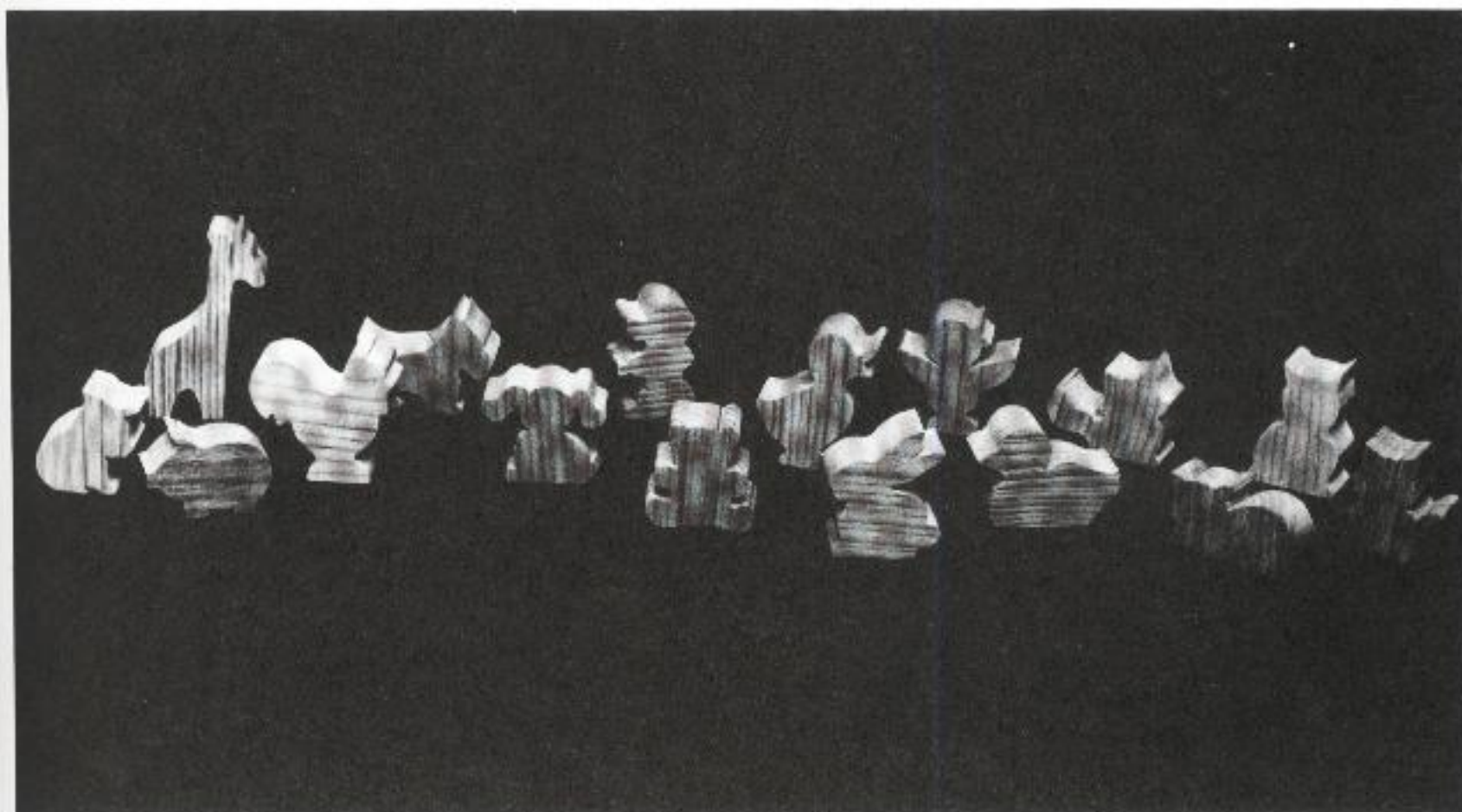

*Mini-animal cutouts.*

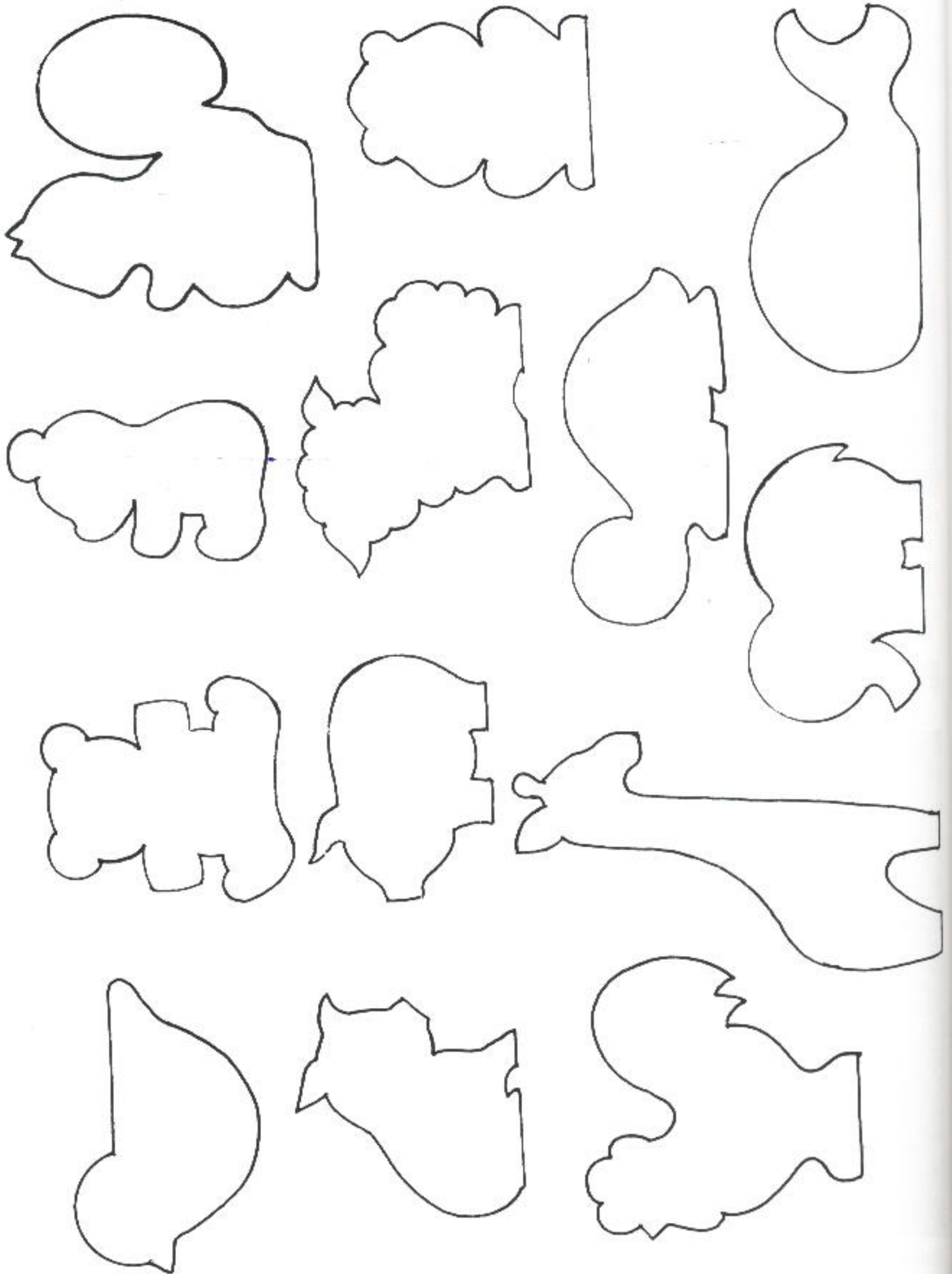

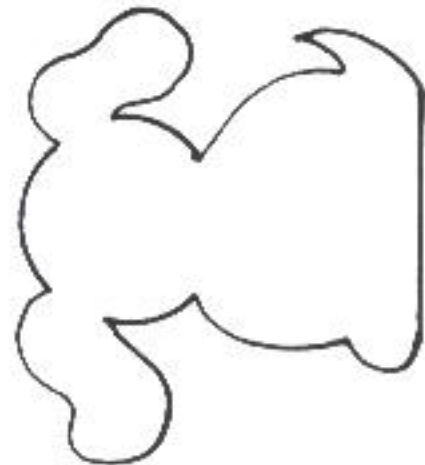
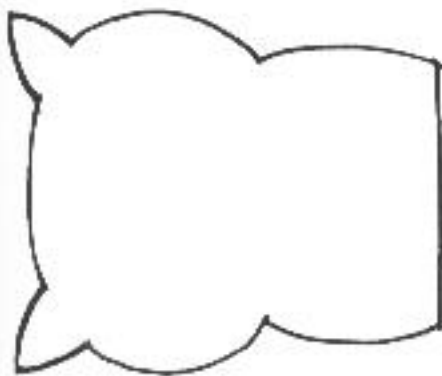
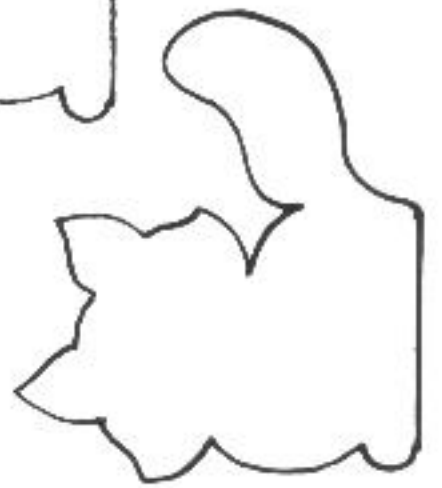
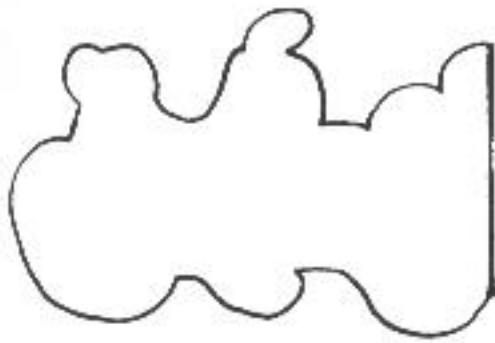
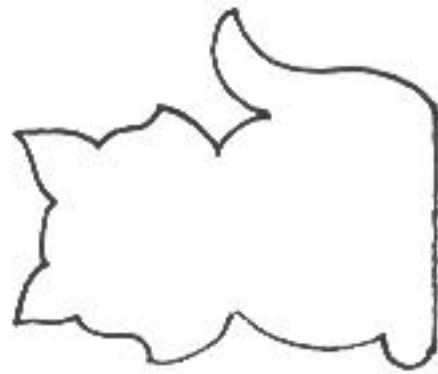
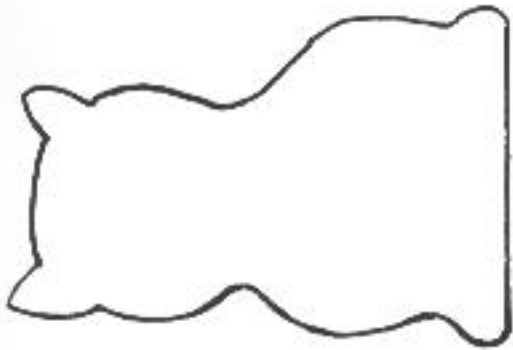
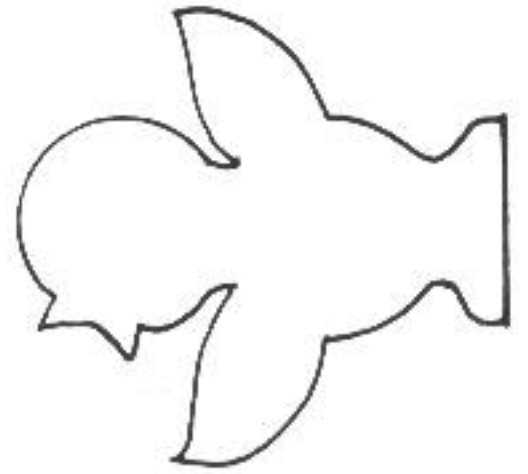
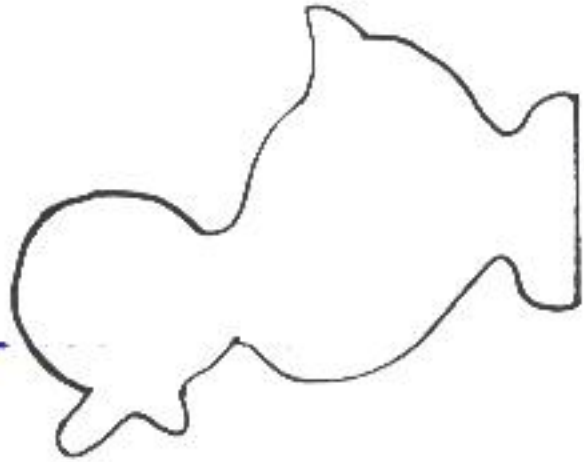
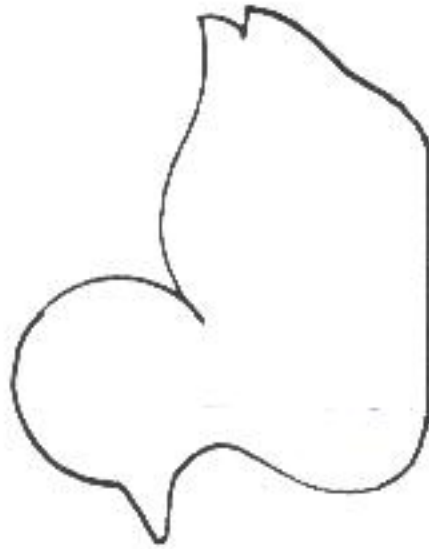
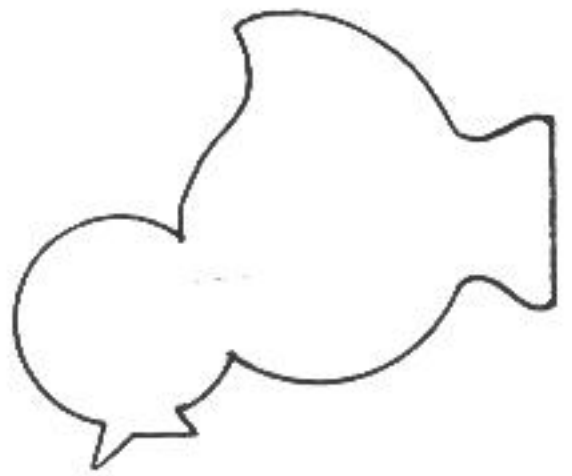
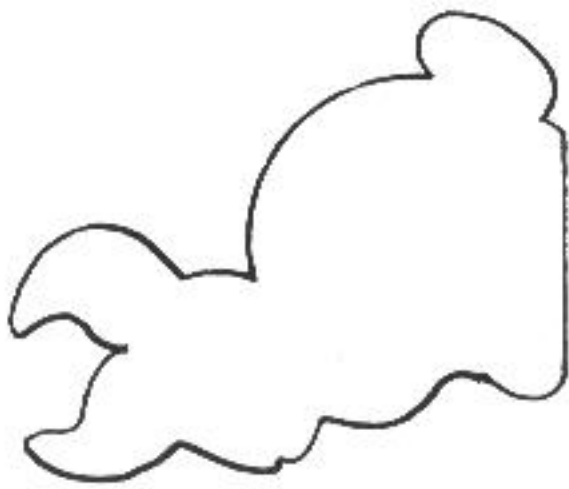

# Belt Hook Designs

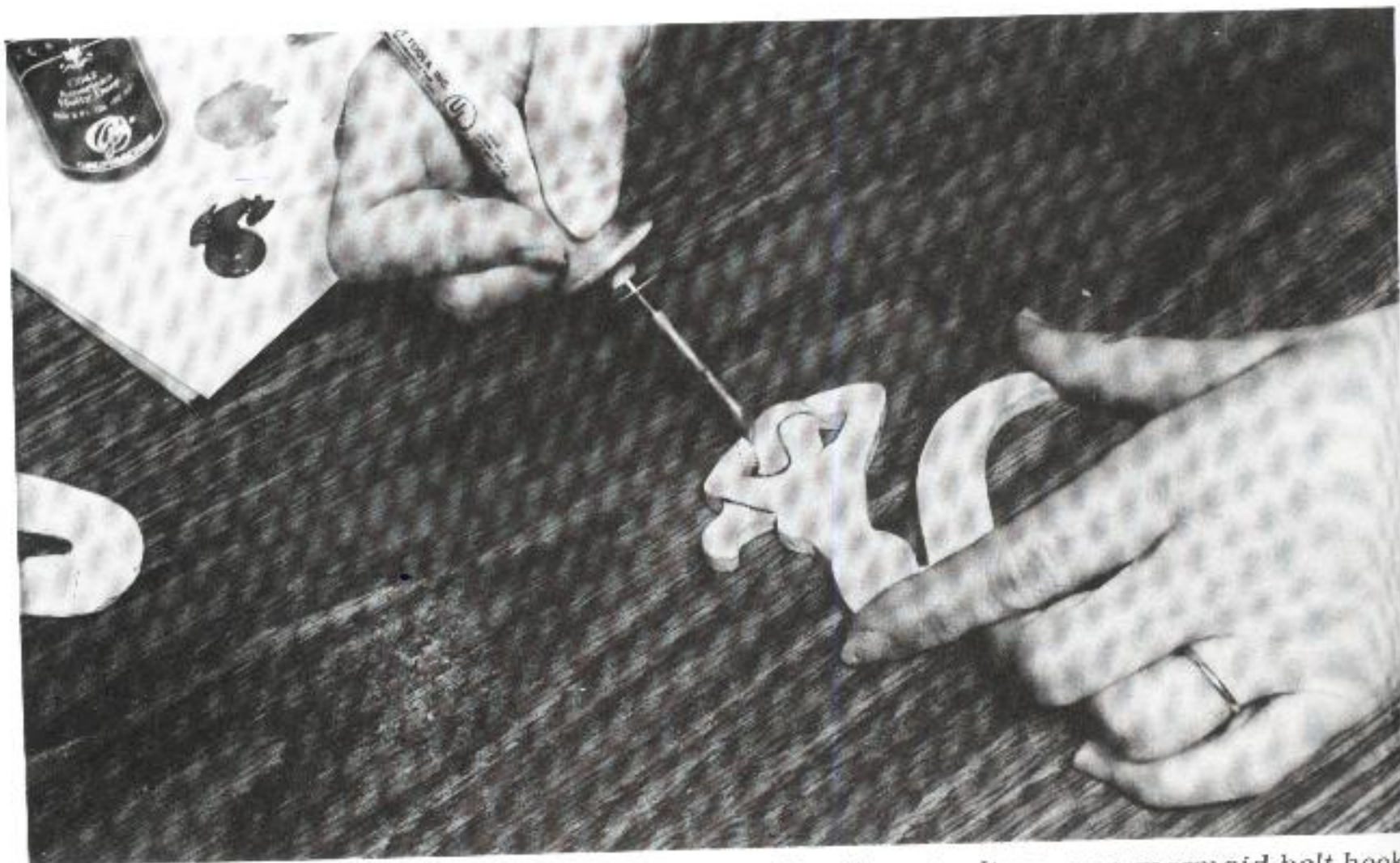

*Woodburning lines on a mermaid belt hook.*

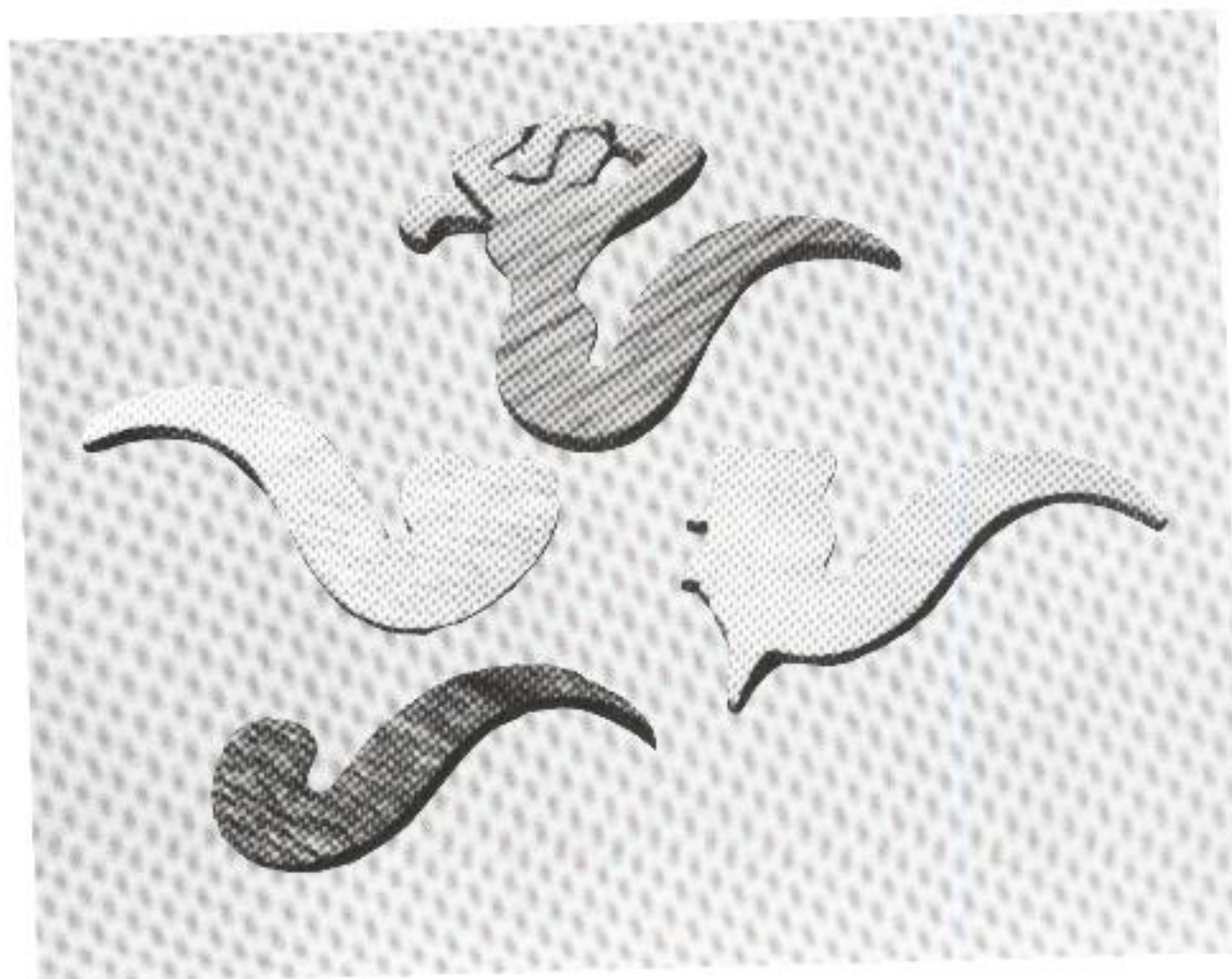

*A variety of belt hook designs cut from 1/4- to 3/8-inch stock.*



hook.

hook  
1/4- to

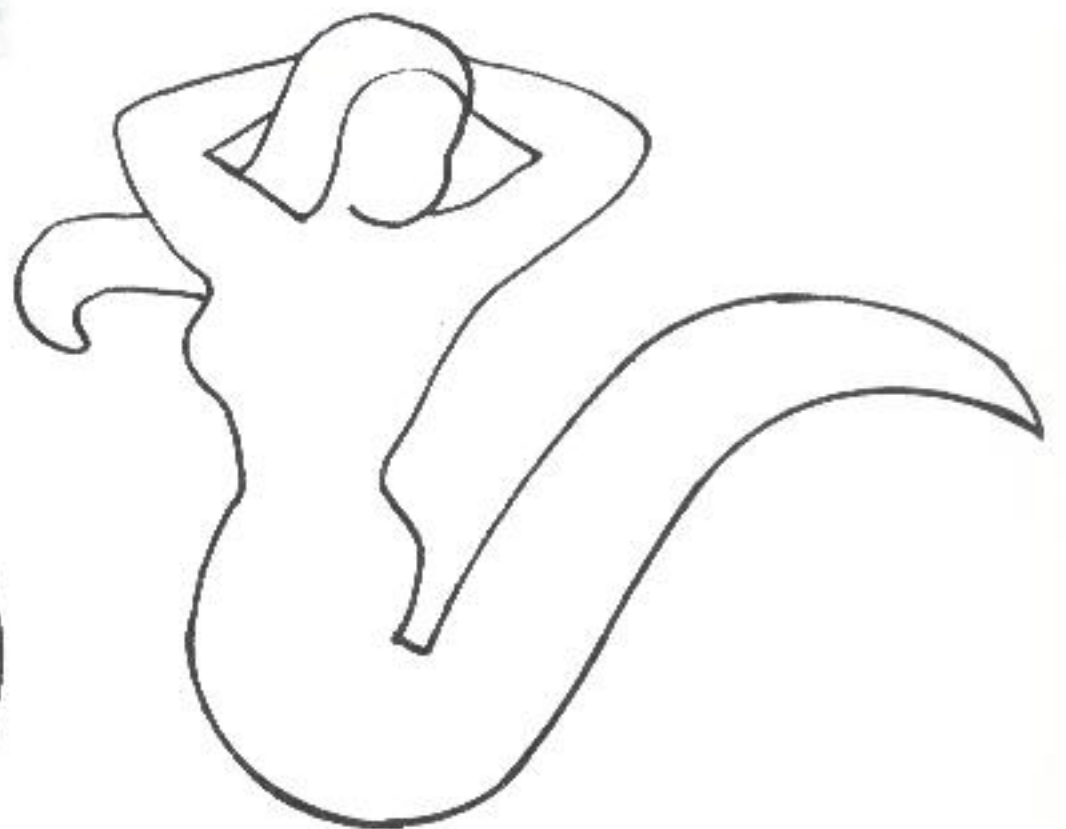
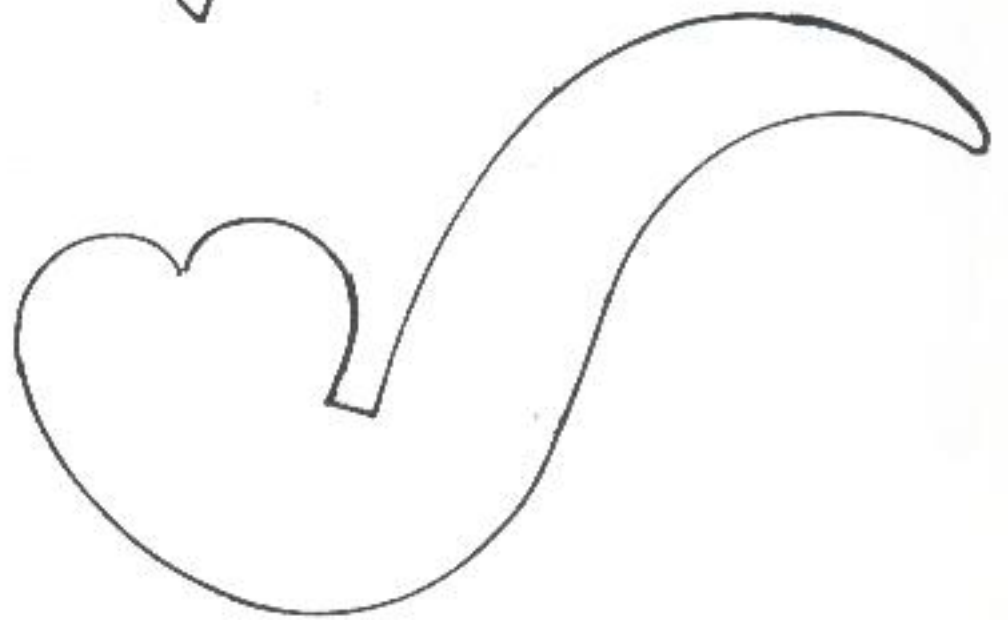
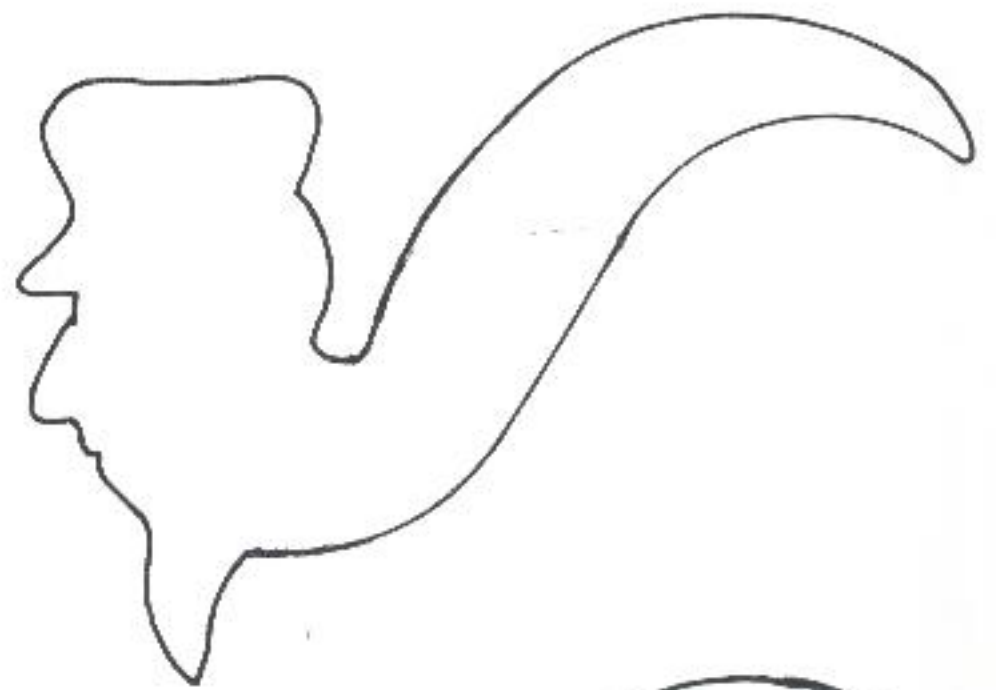
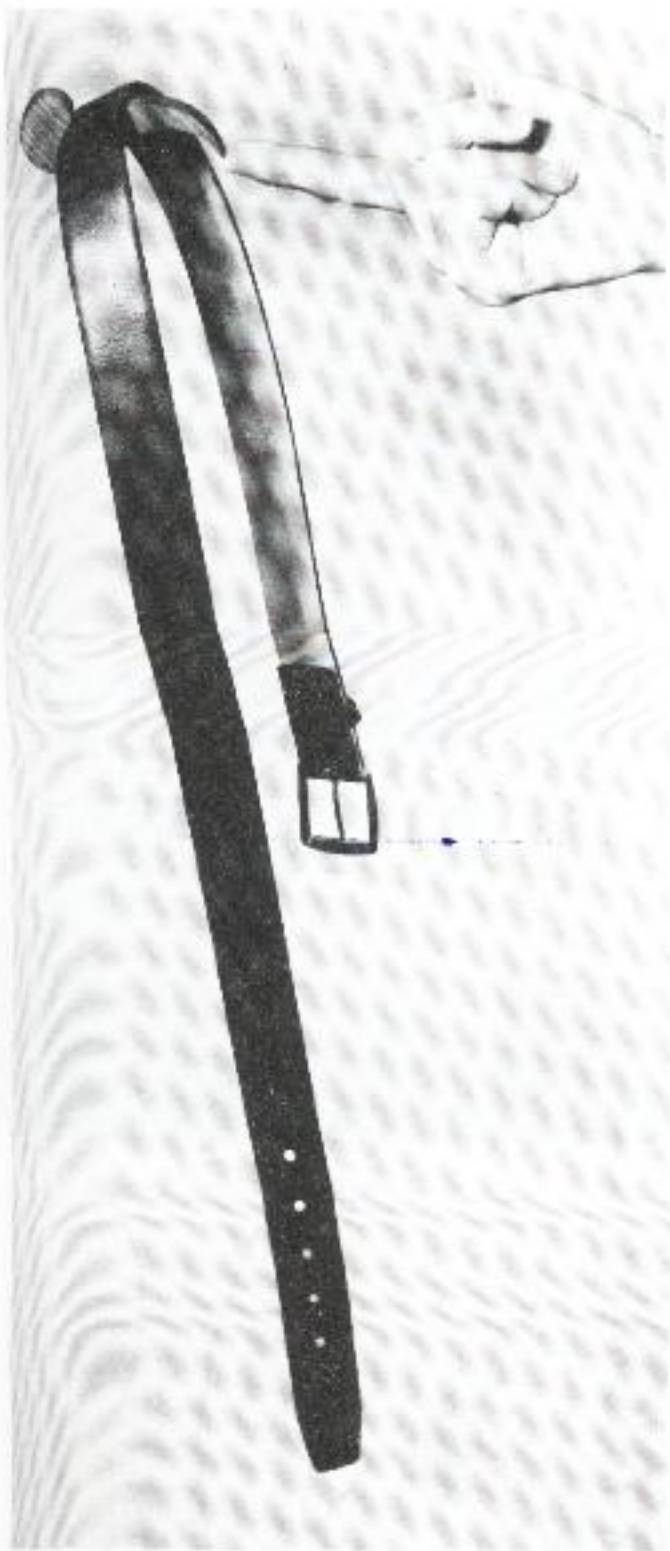

# Cat and Flowers

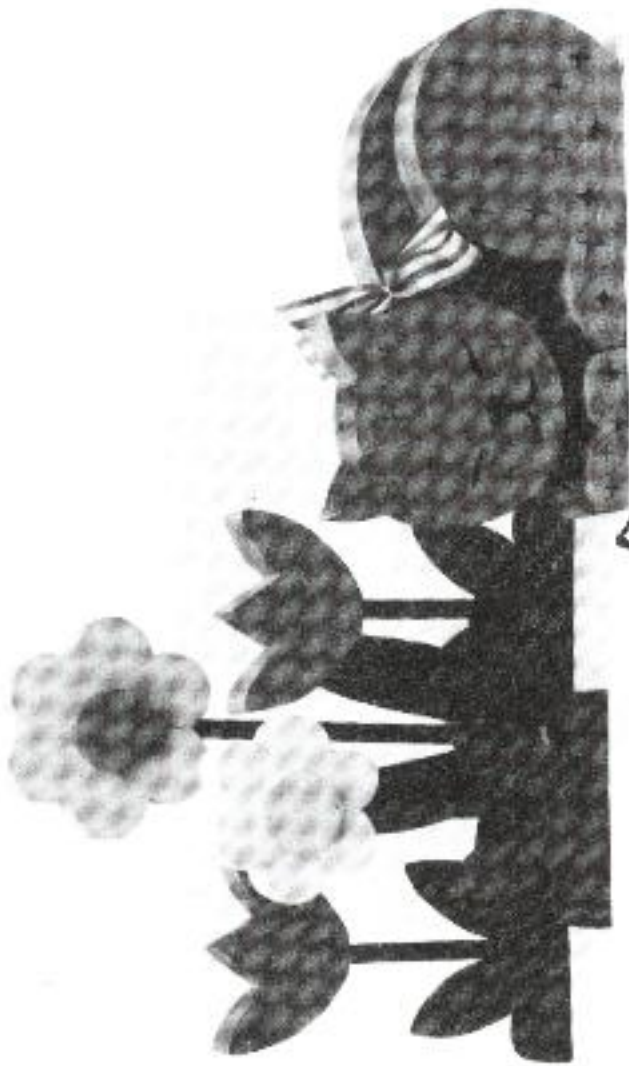

*Cat and patterns. Patterns for these flowers can be found on pages 36 and 37.*

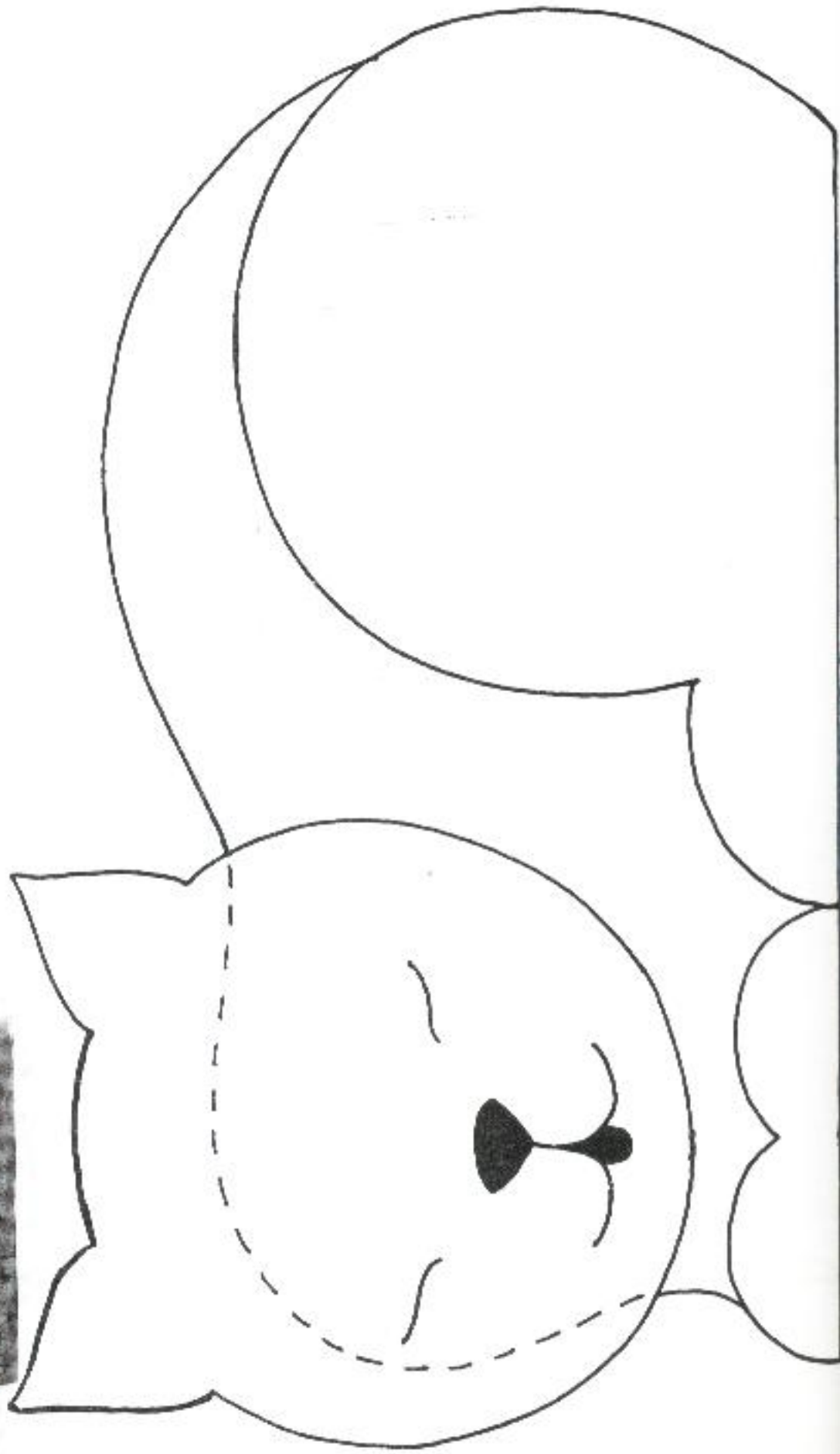

# Dimensional Animal Cutouts

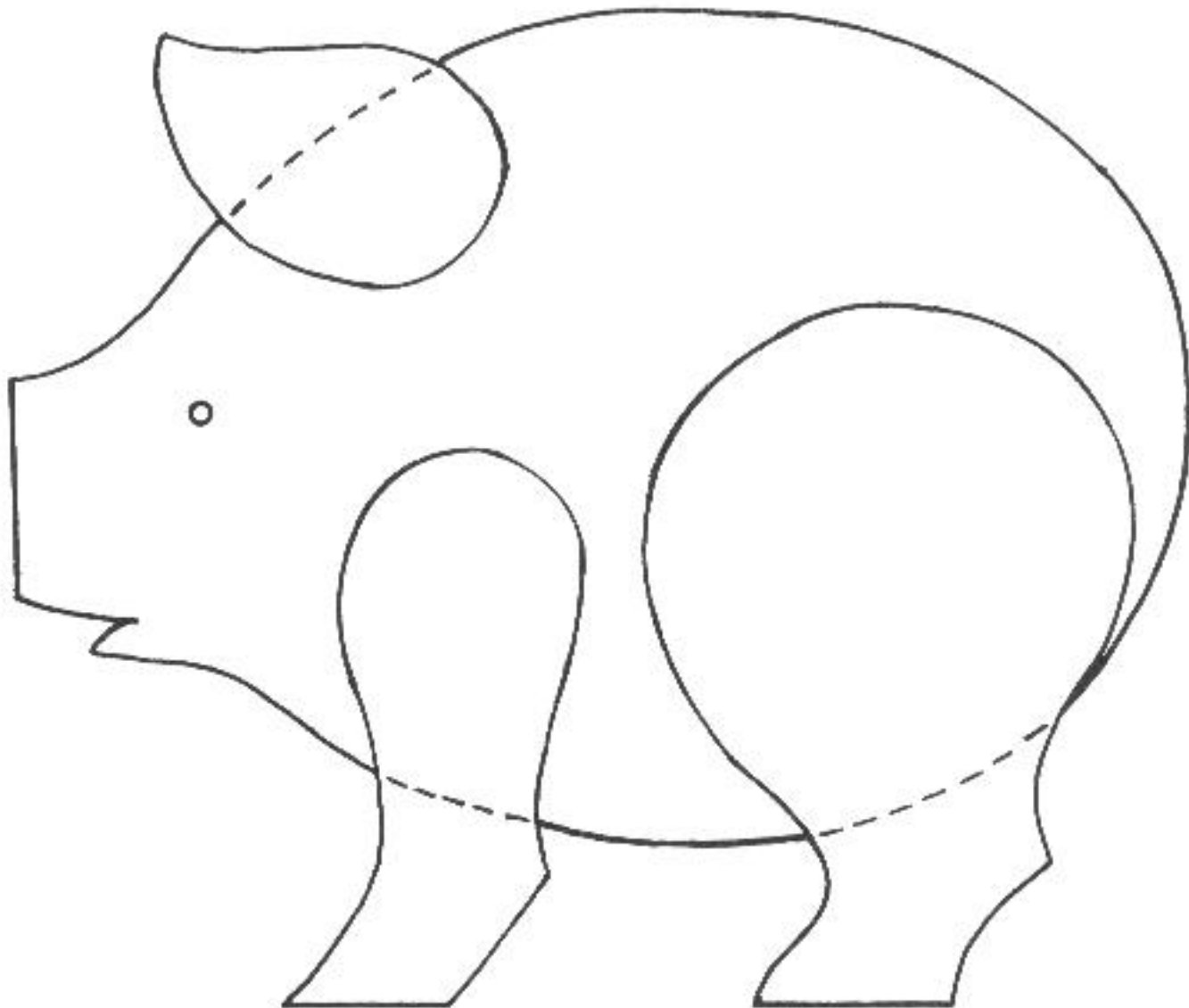
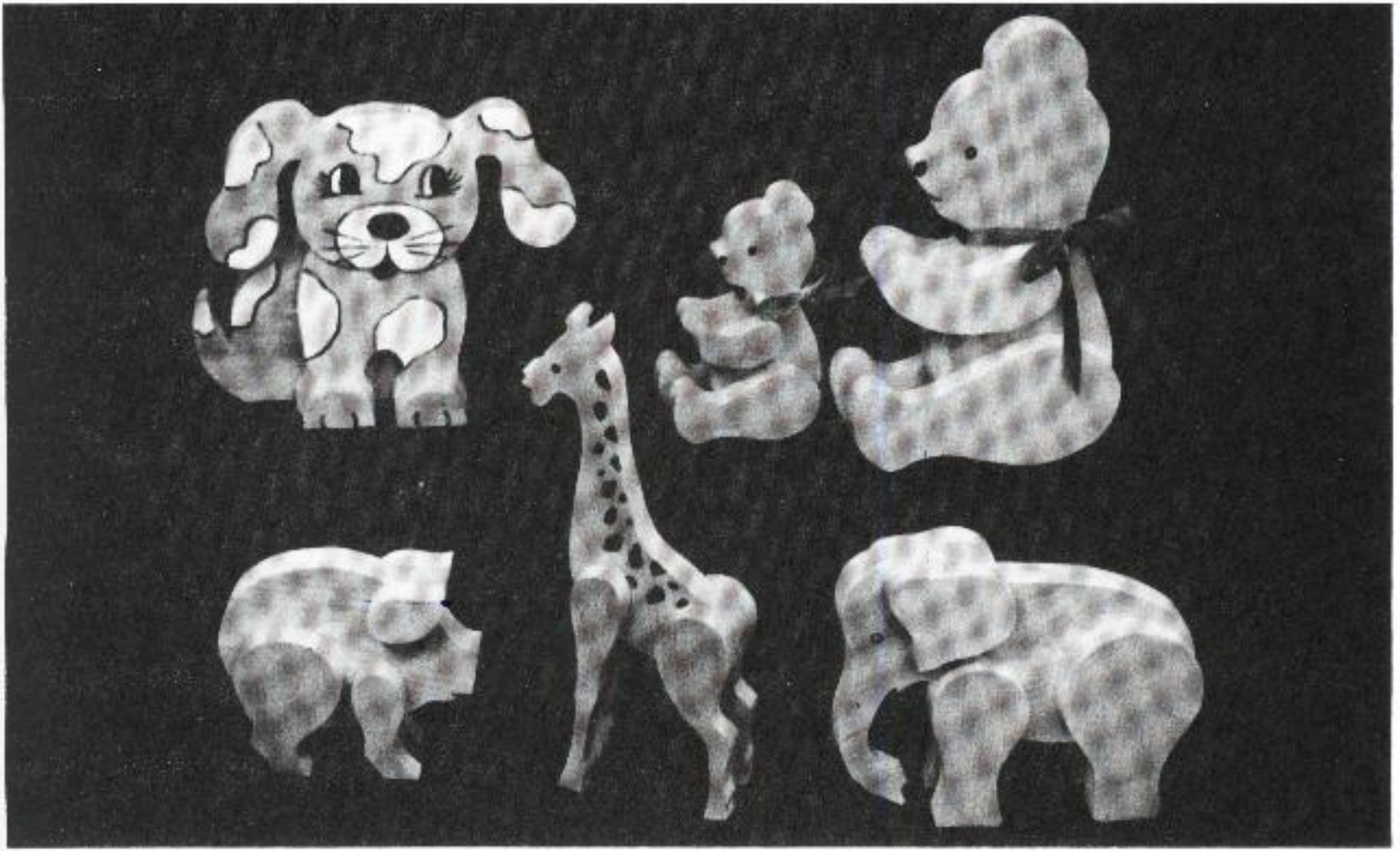

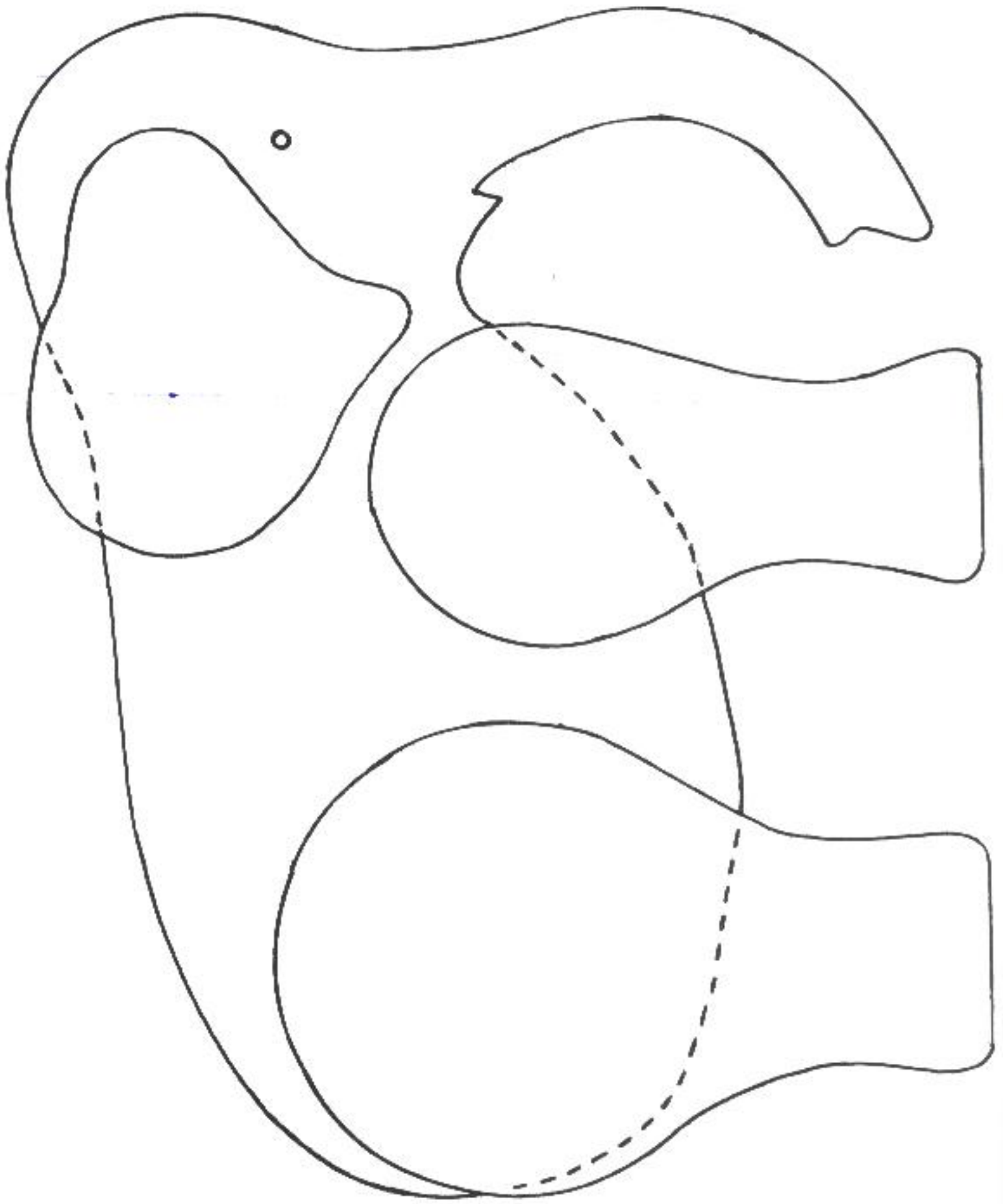



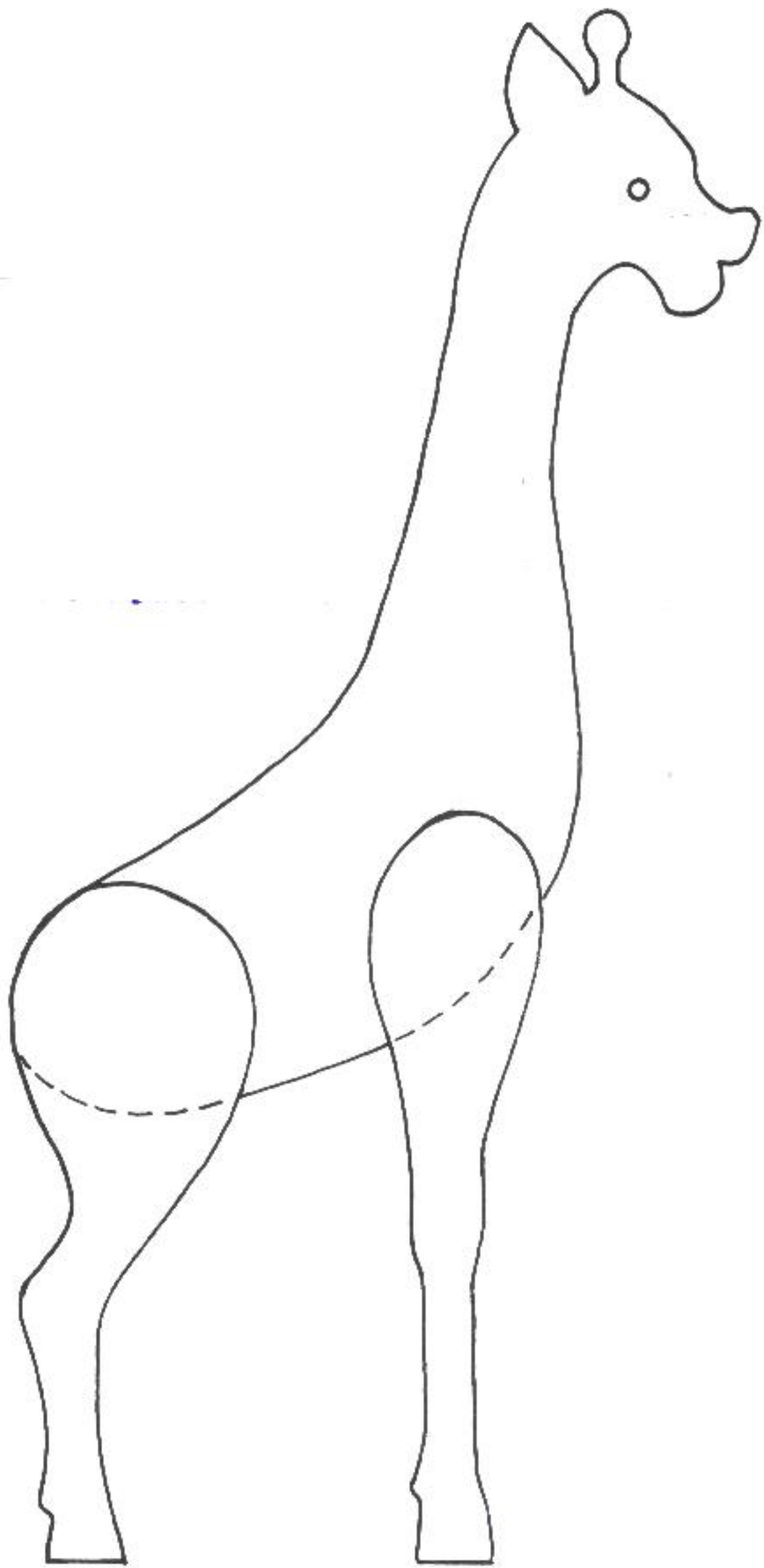

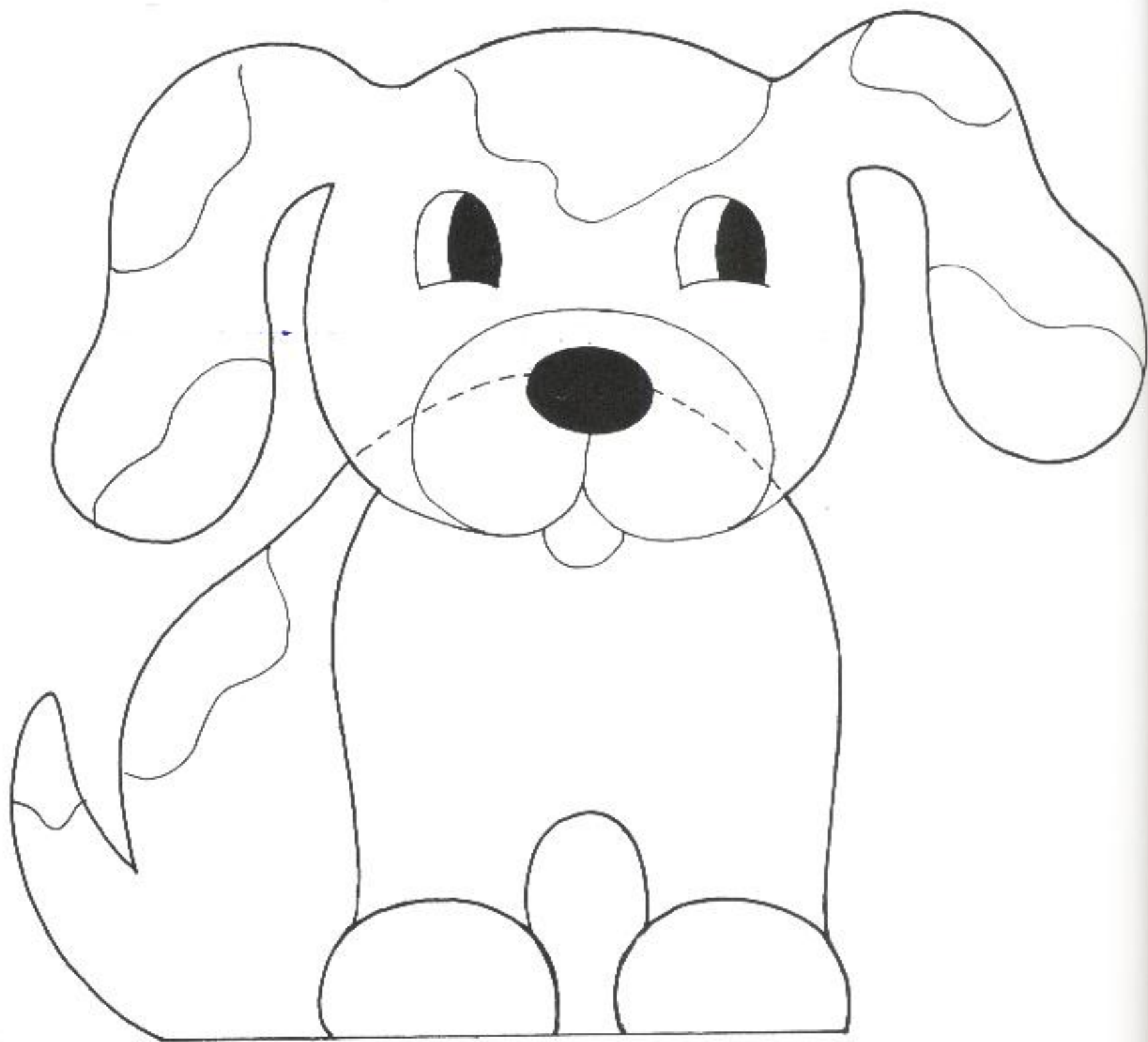

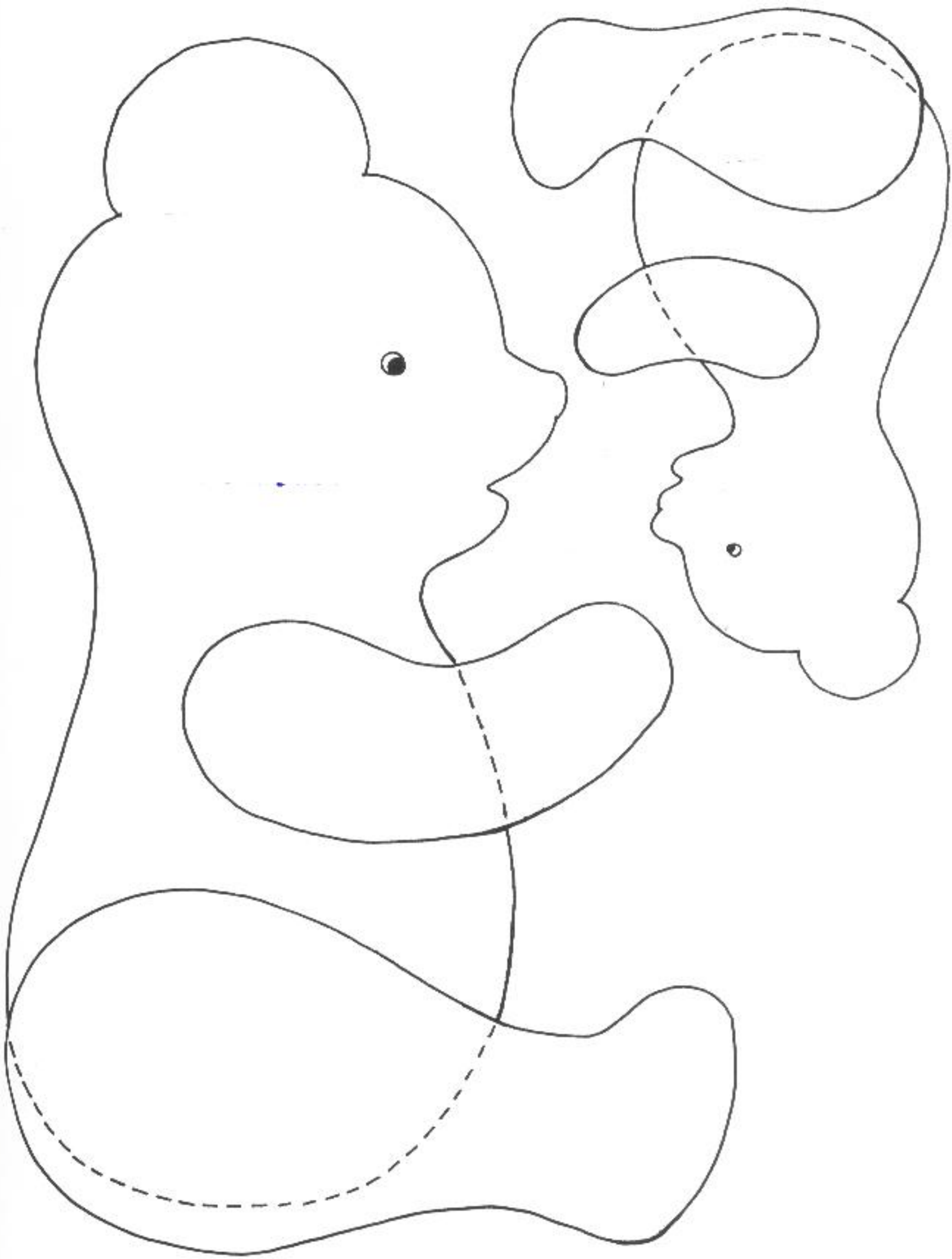

# Refrigerator Magnets/ "Pets on a Stick"



The refrigerator magnets are cut from 1/4-inch stock; epoxy is put on purchased magnets. Patterns for refrigerator magnets can be found on pages 99 and 100.



"Pets on a stick." Patterns for the "Pets" can be found on pages 101 and 102.

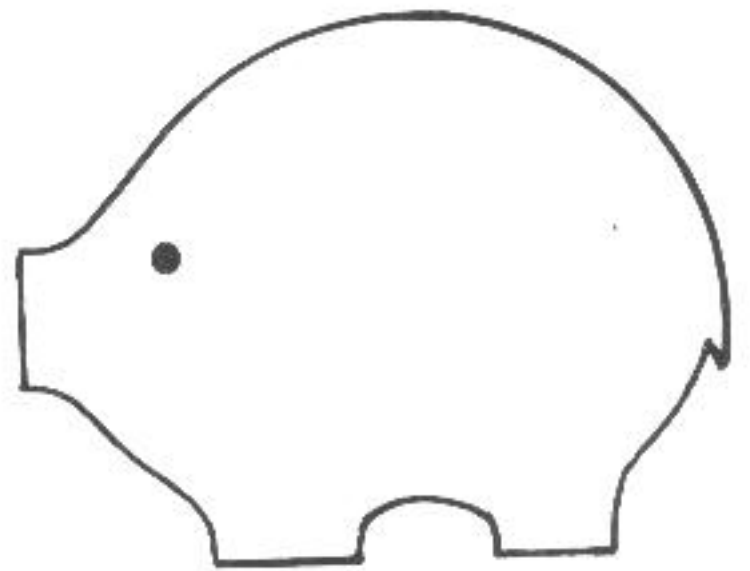
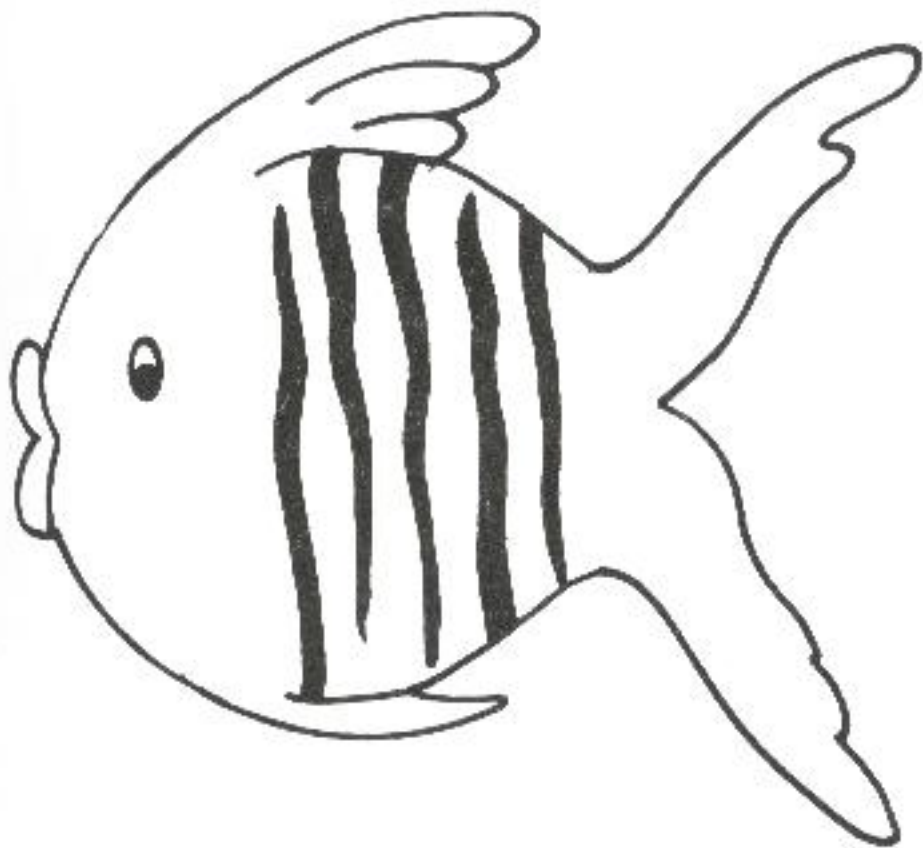
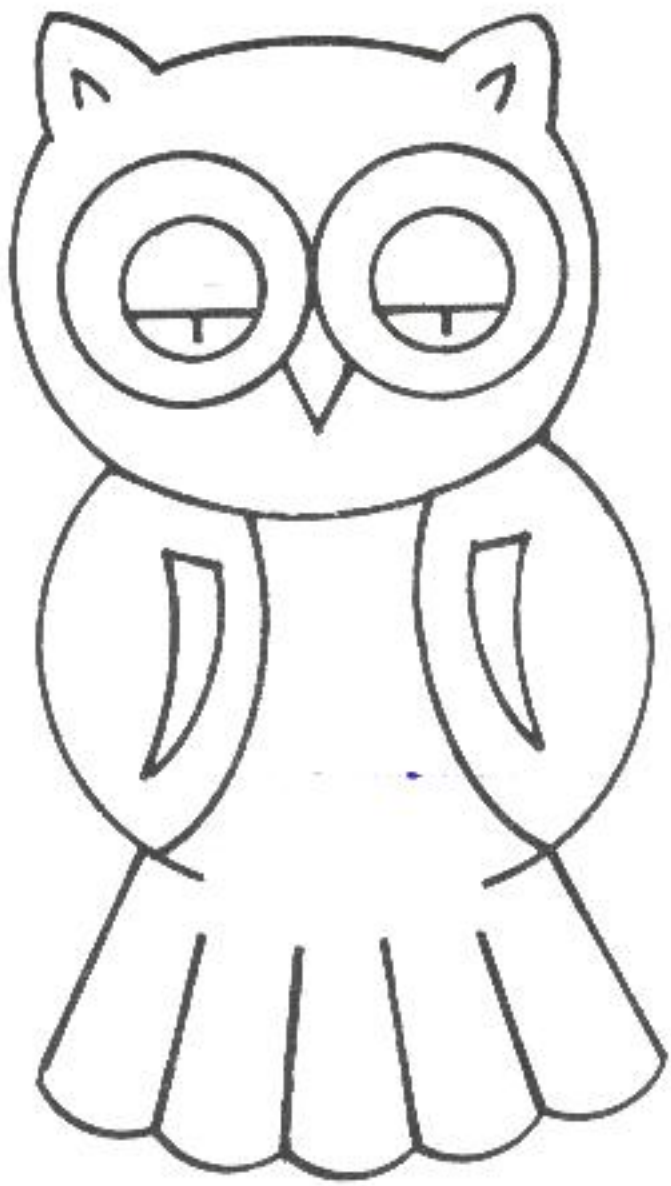

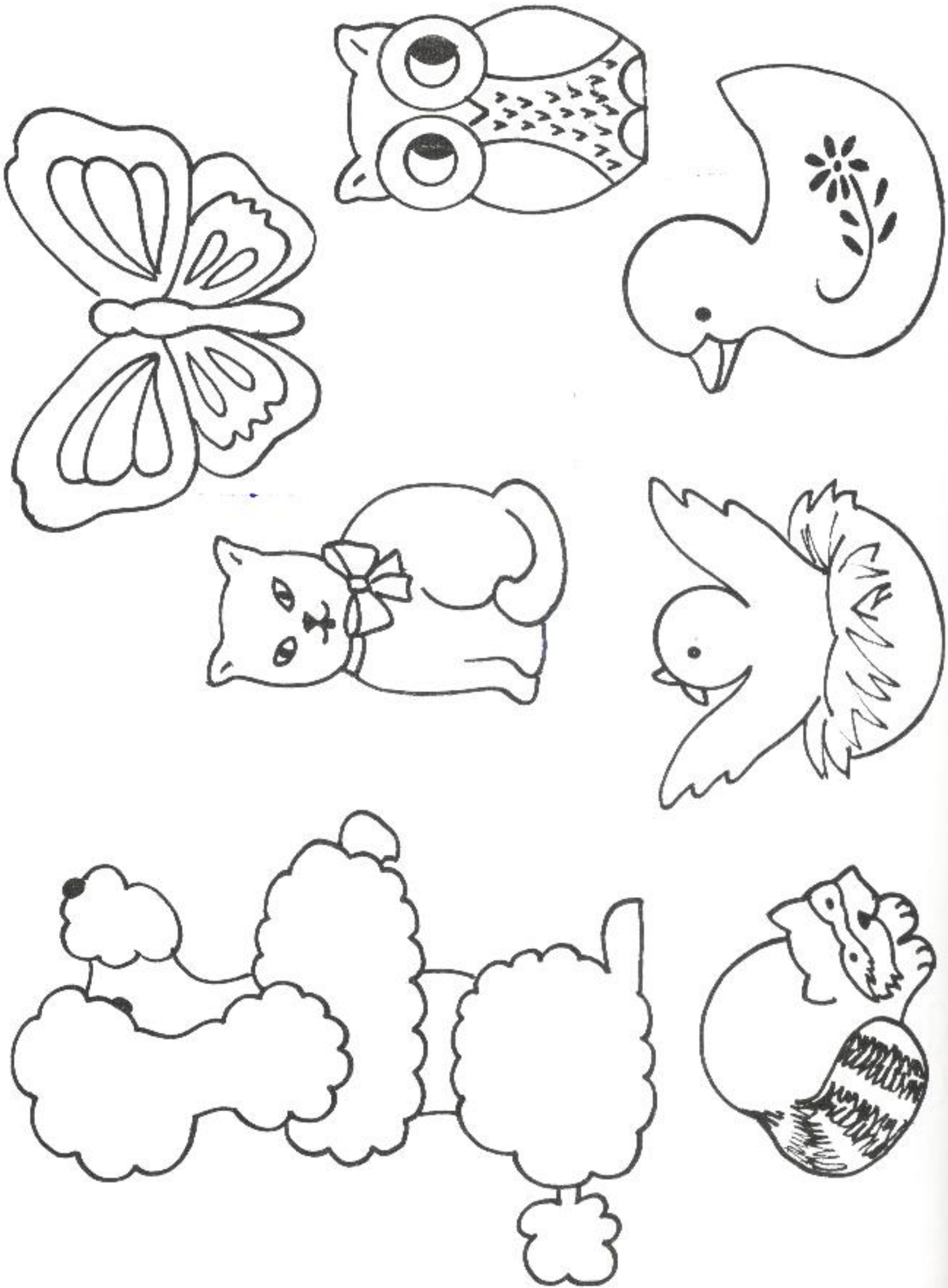

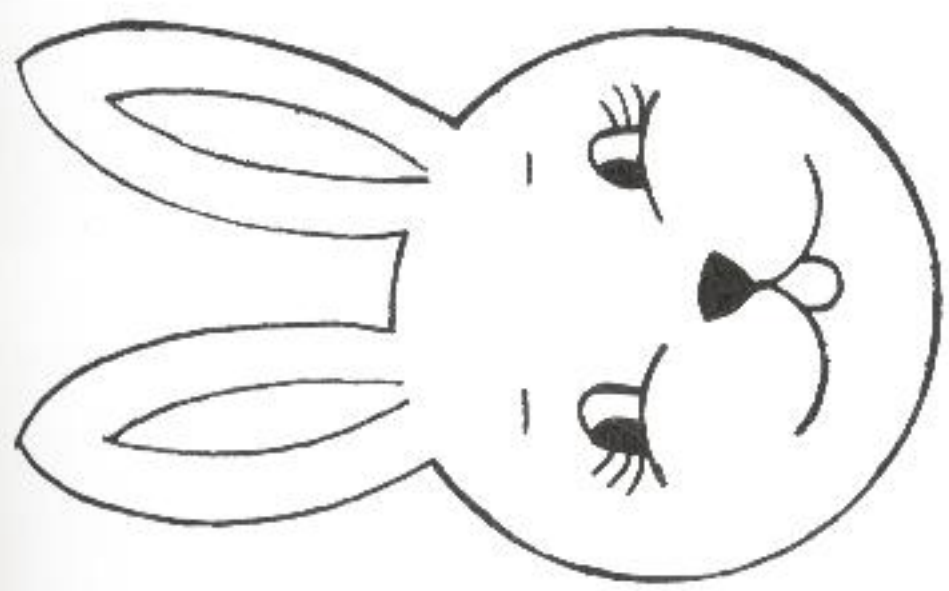
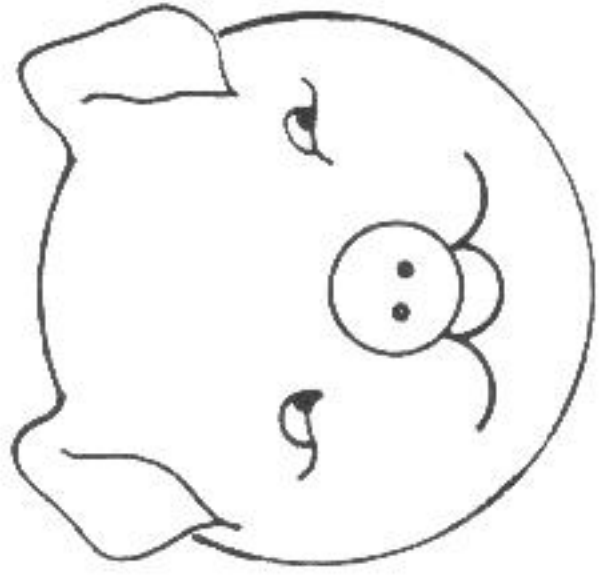
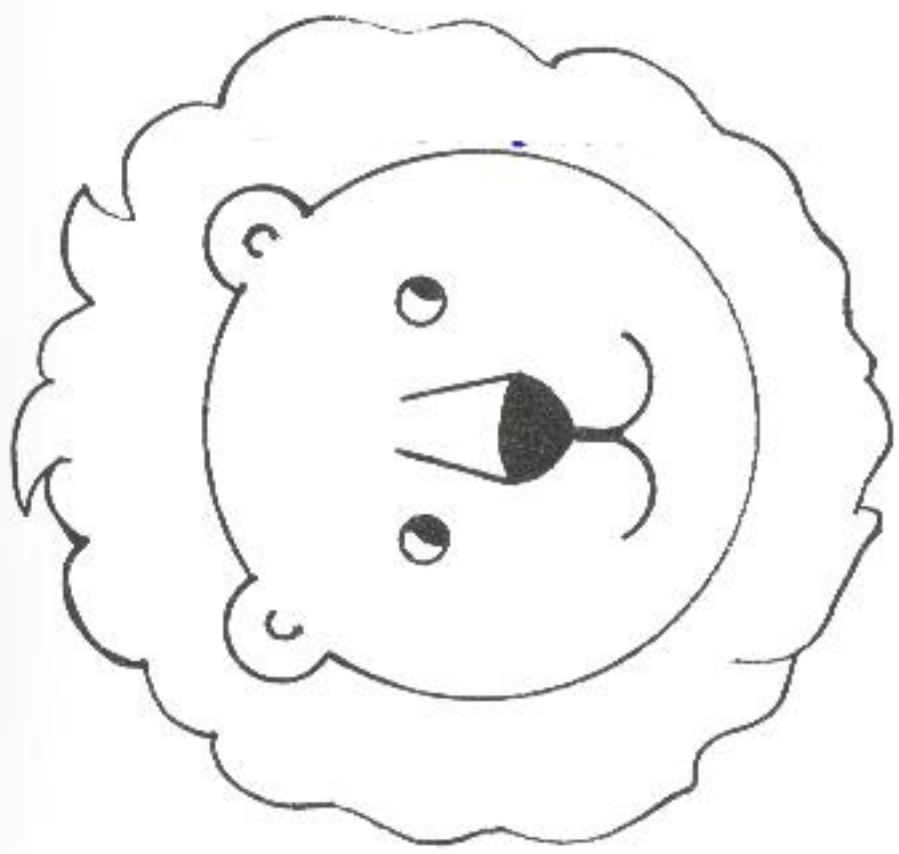
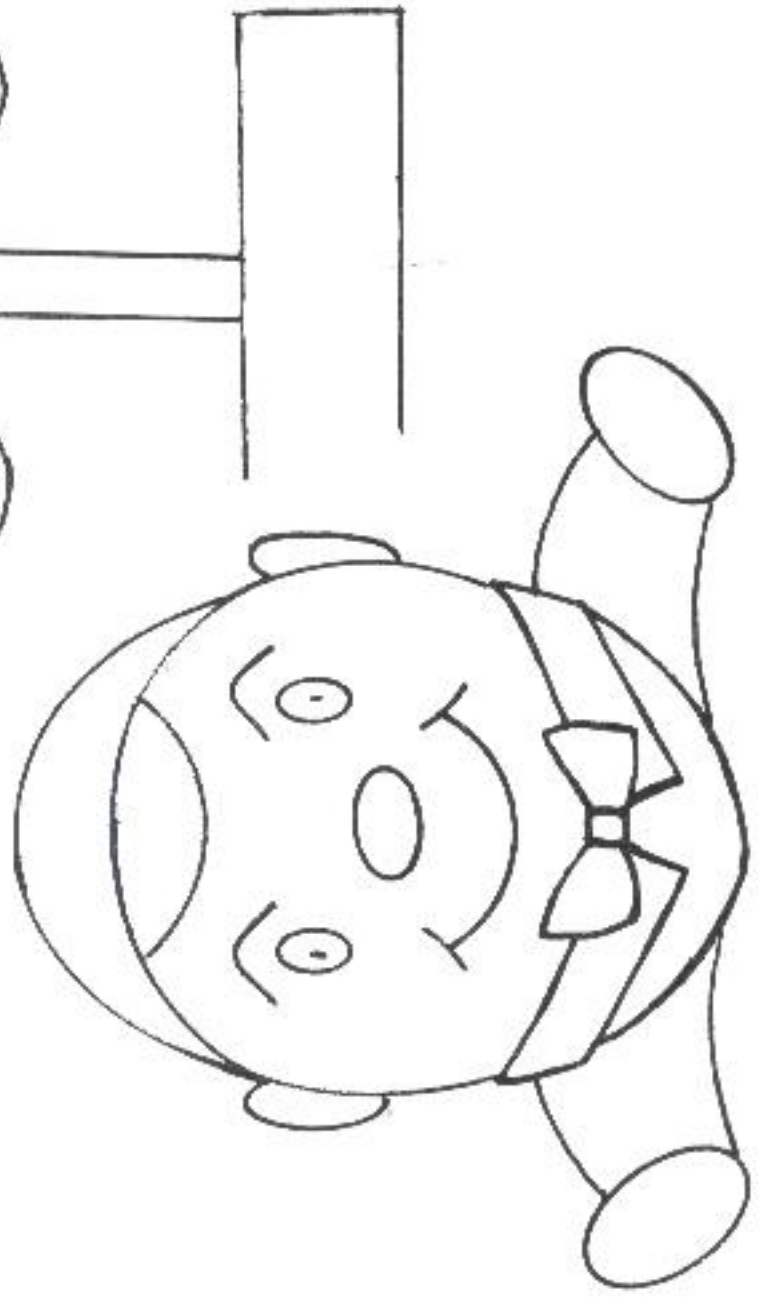
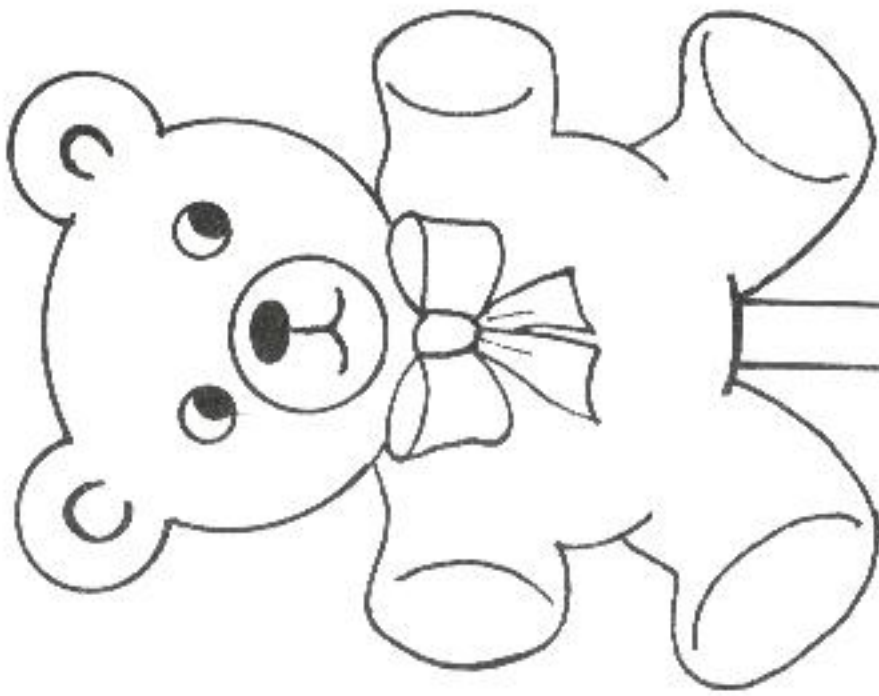

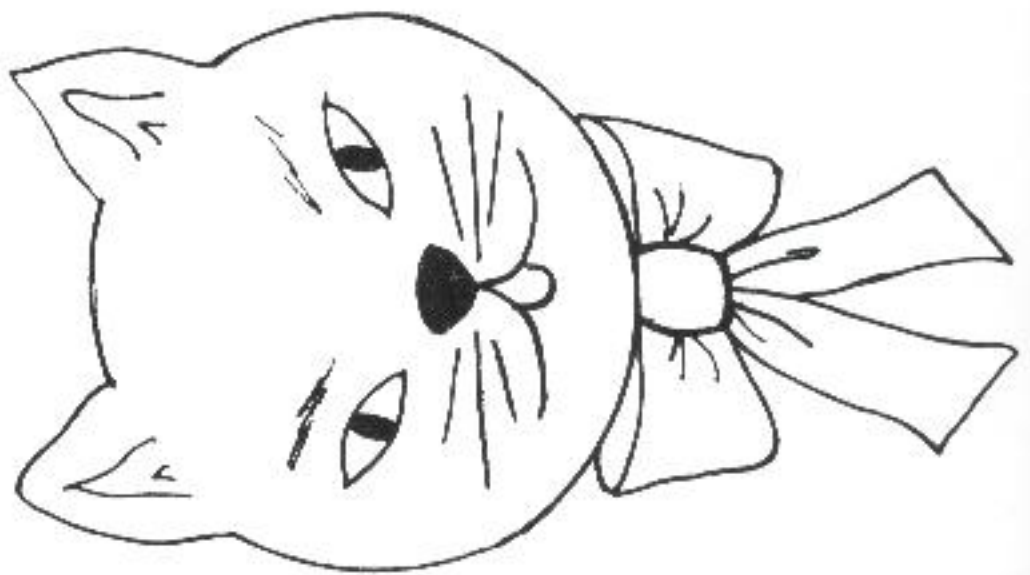
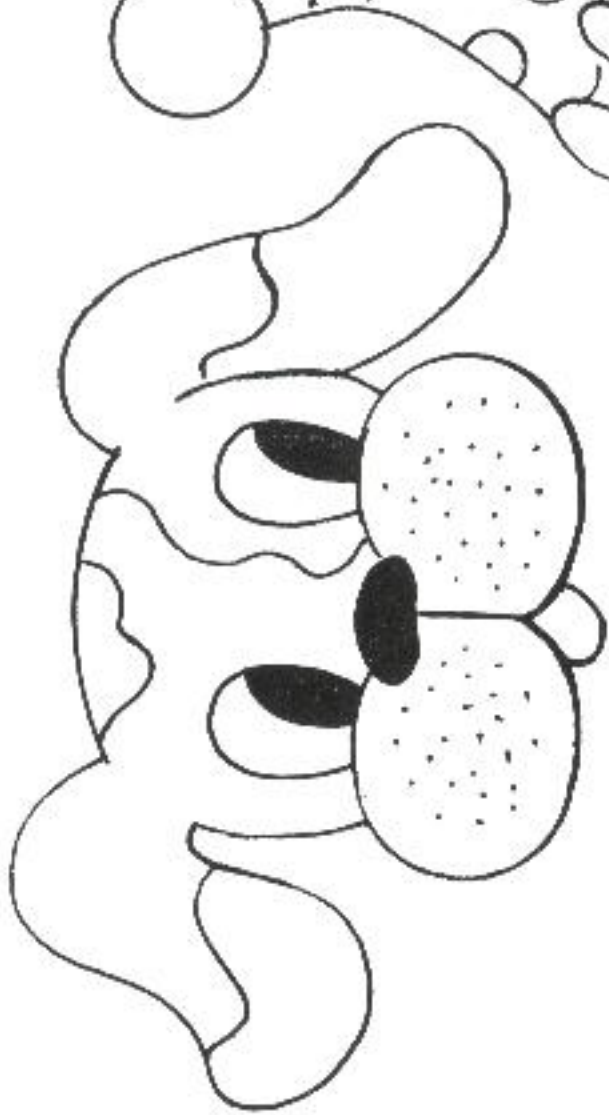
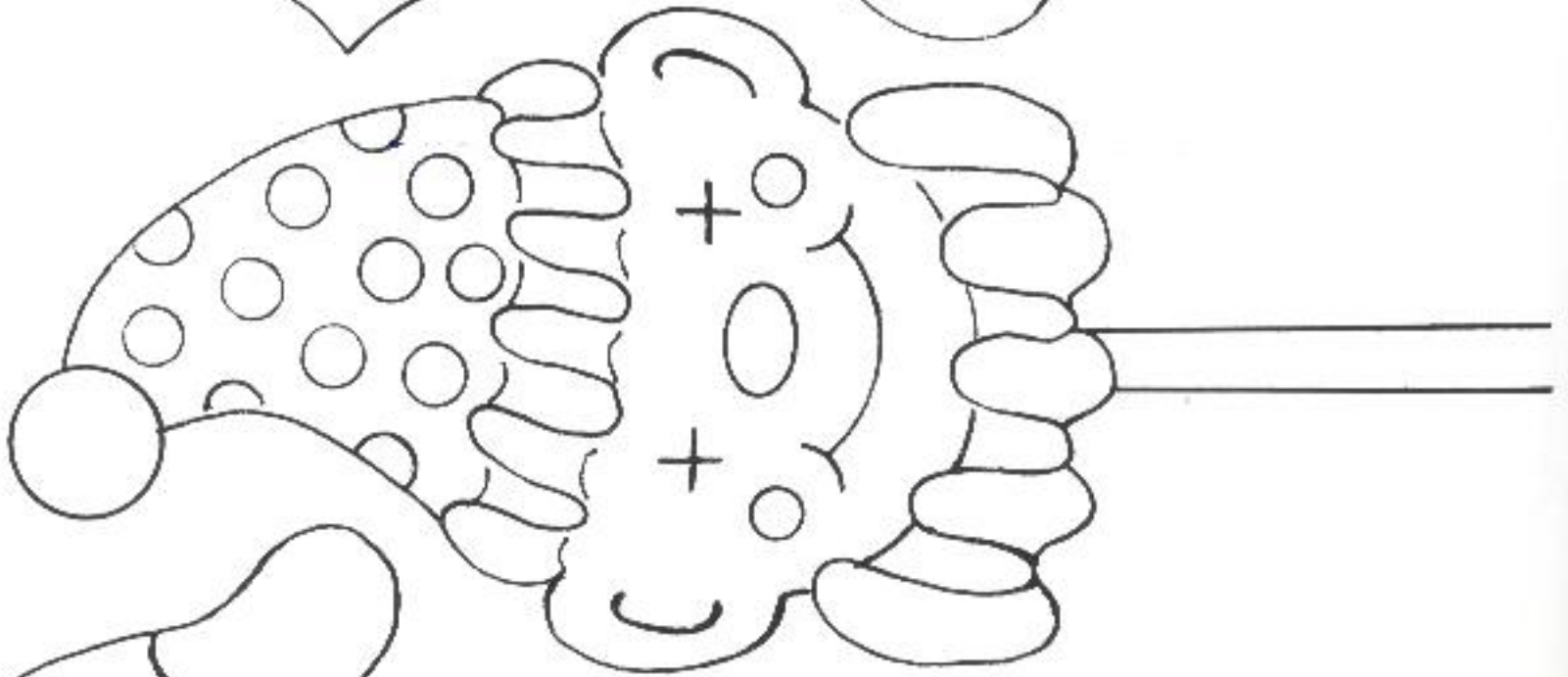
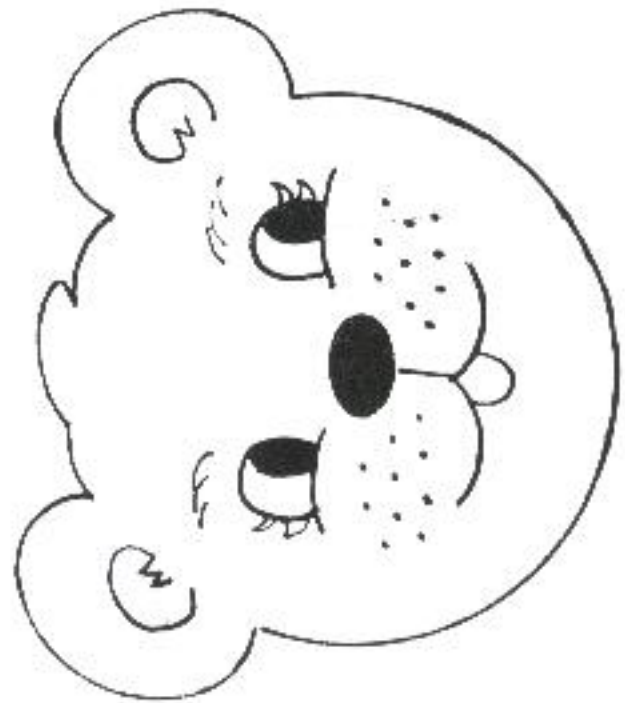
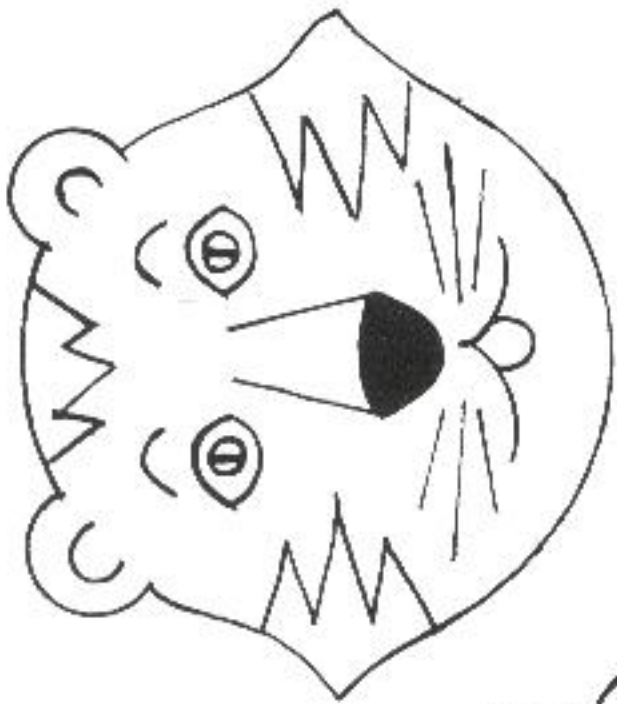



# More Friendly Creatures

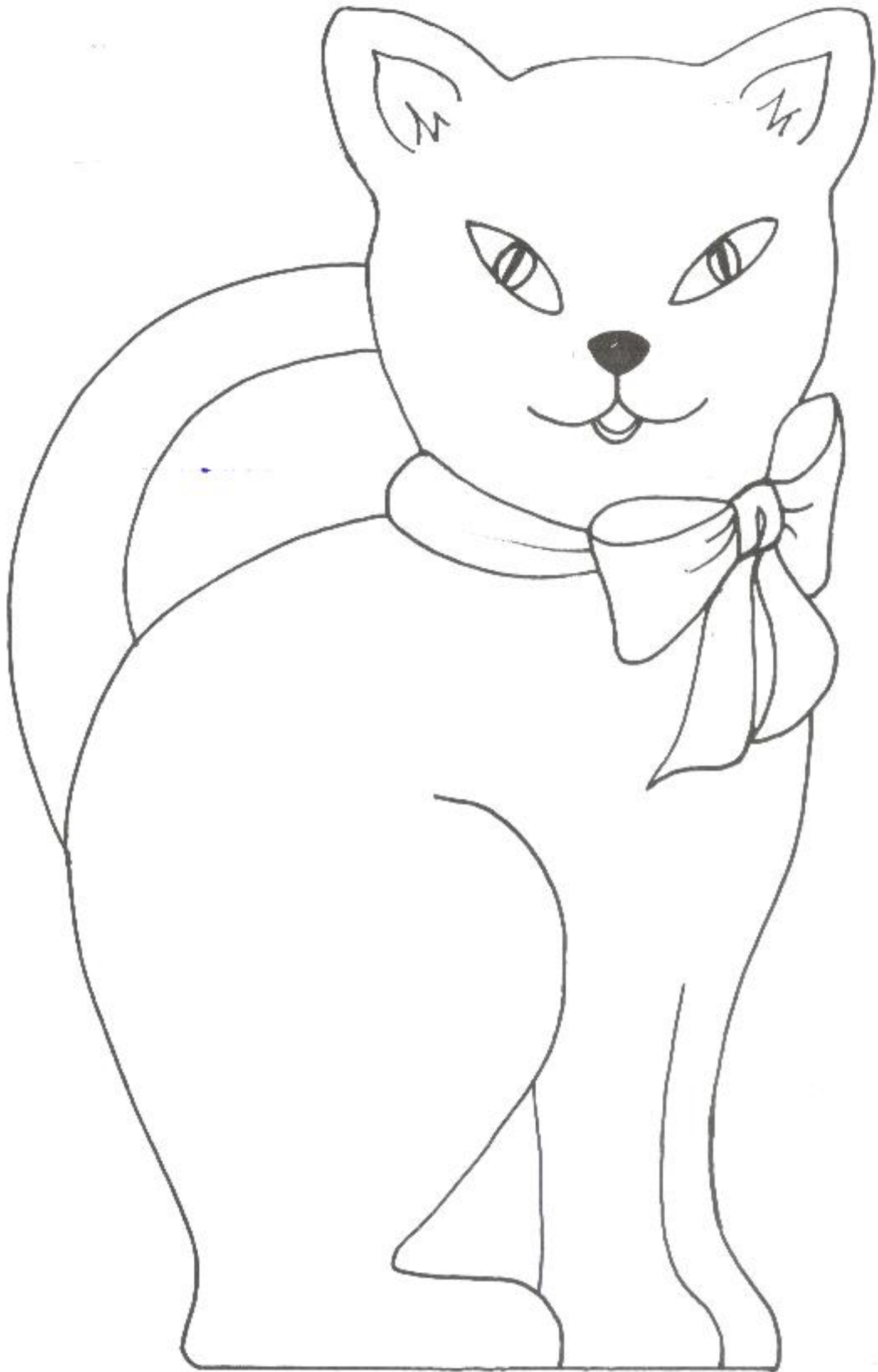

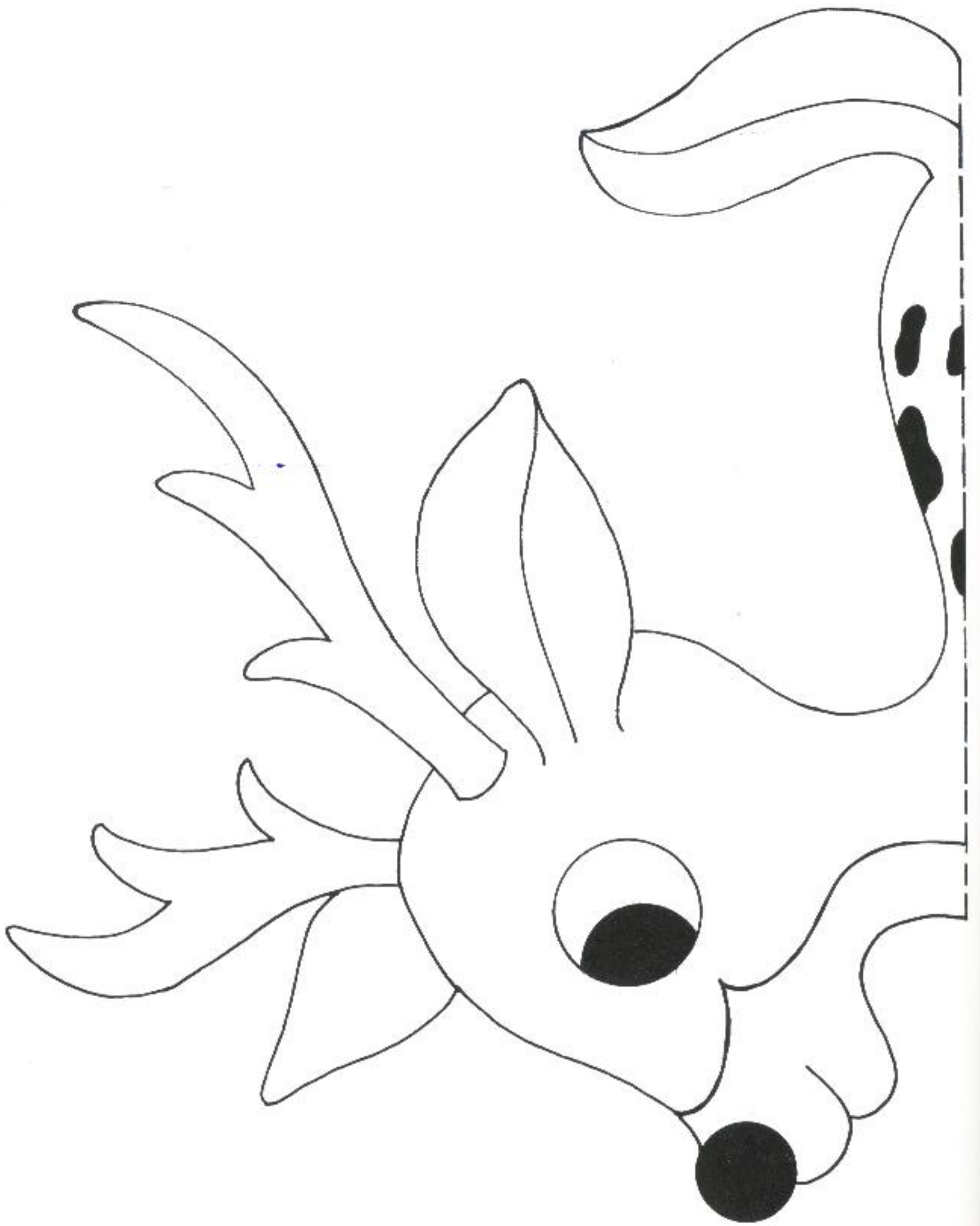



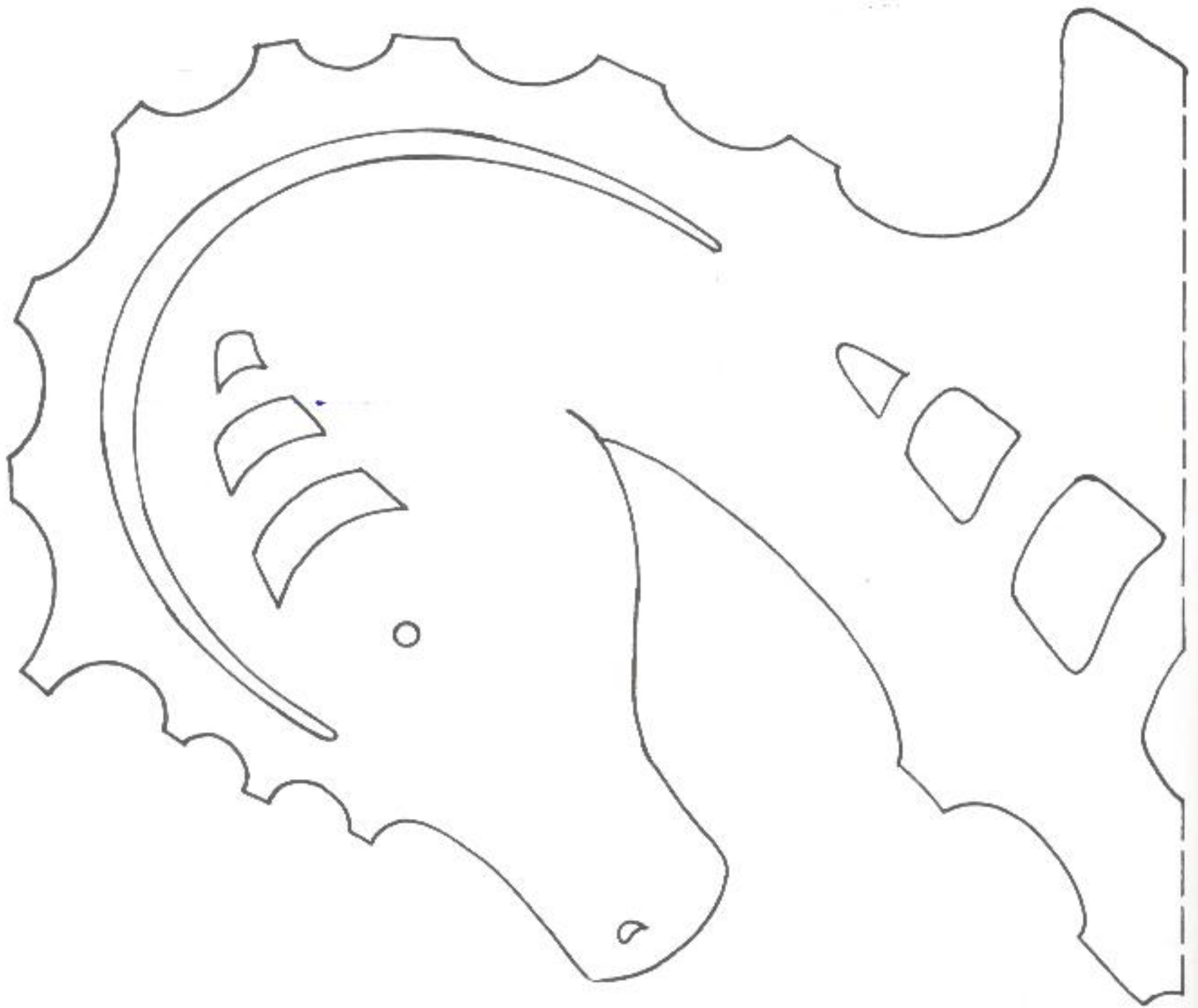

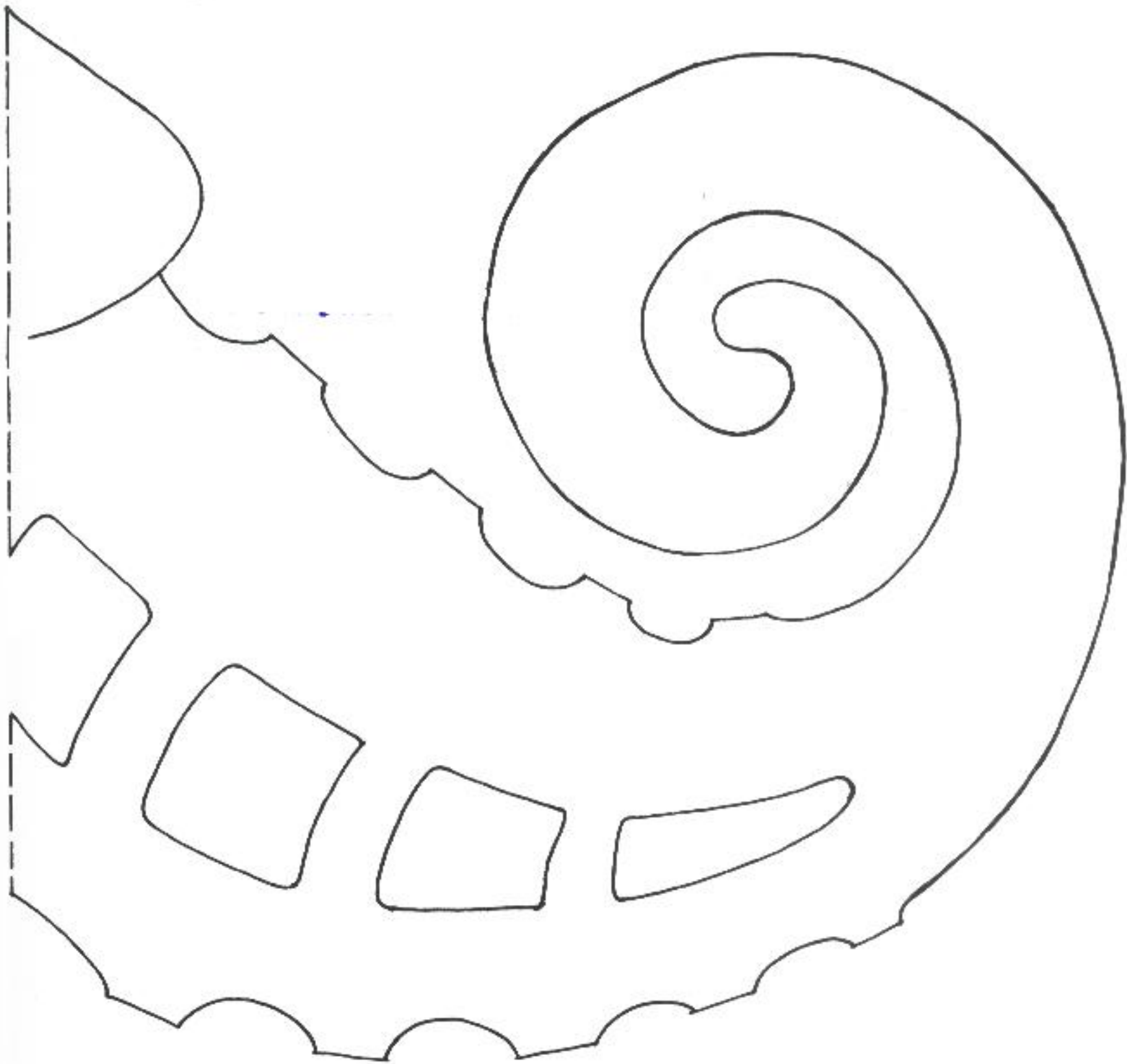

# Napkin Rings/Puzzles



Napkin rings. Patterns can be found on pages 109–111.

Puzzles. Above: Cutout from thick stock. Below: Inlay puzzle cut from  $\frac{1}{4}$ -inch plywood with  $\frac{1}{4}$ -inch plywood backing. Patterns can be found on pages 112–135.

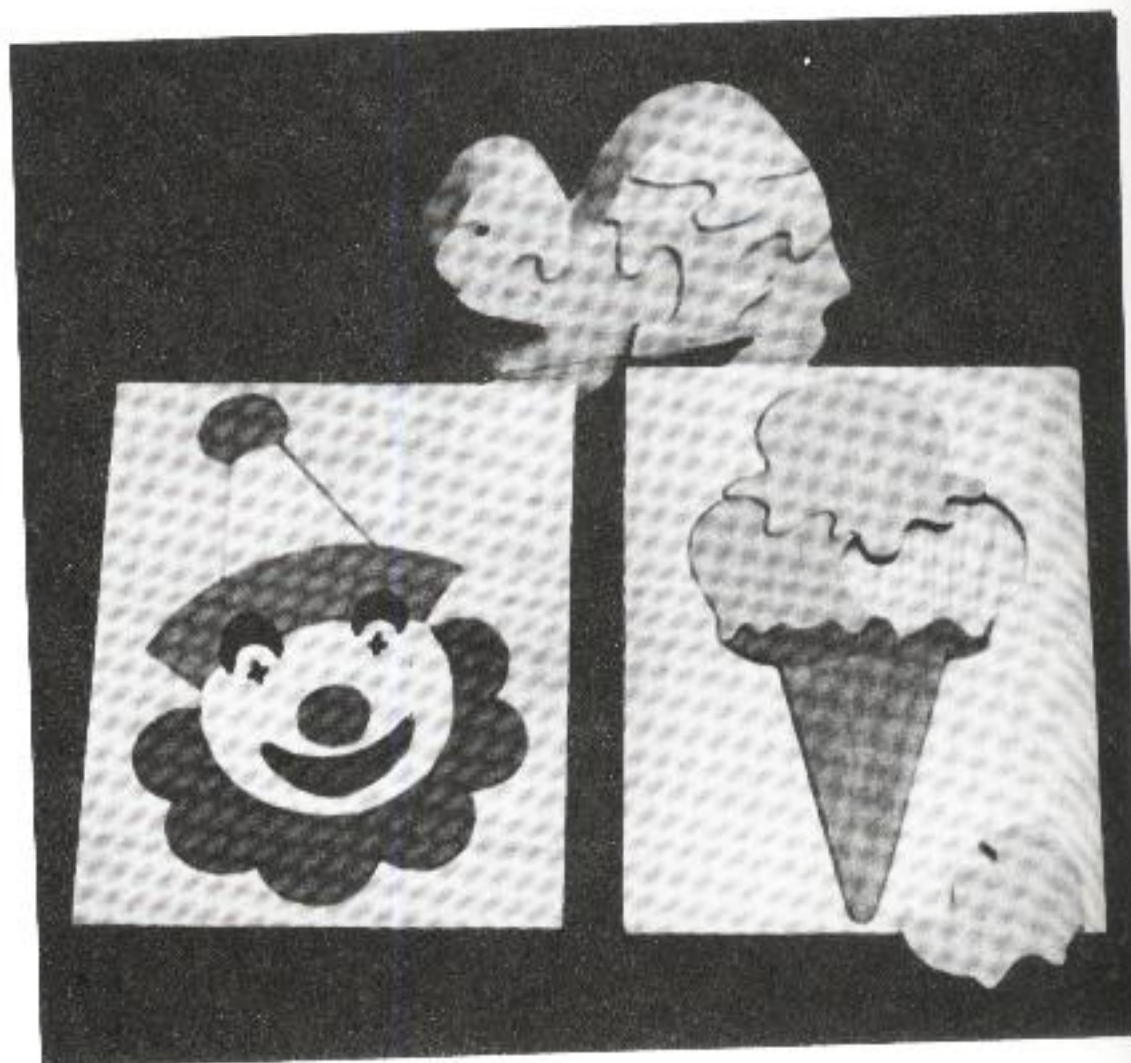

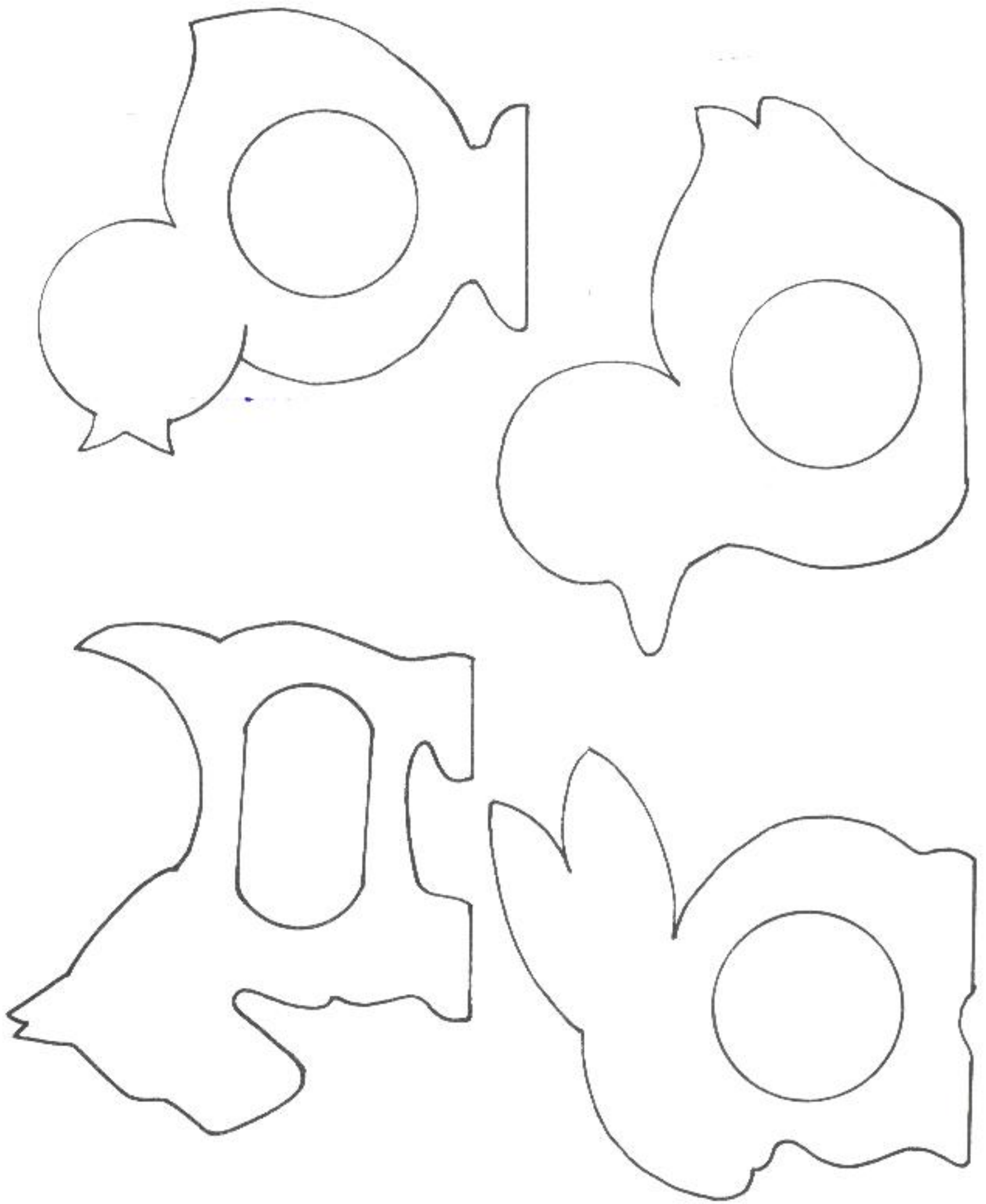

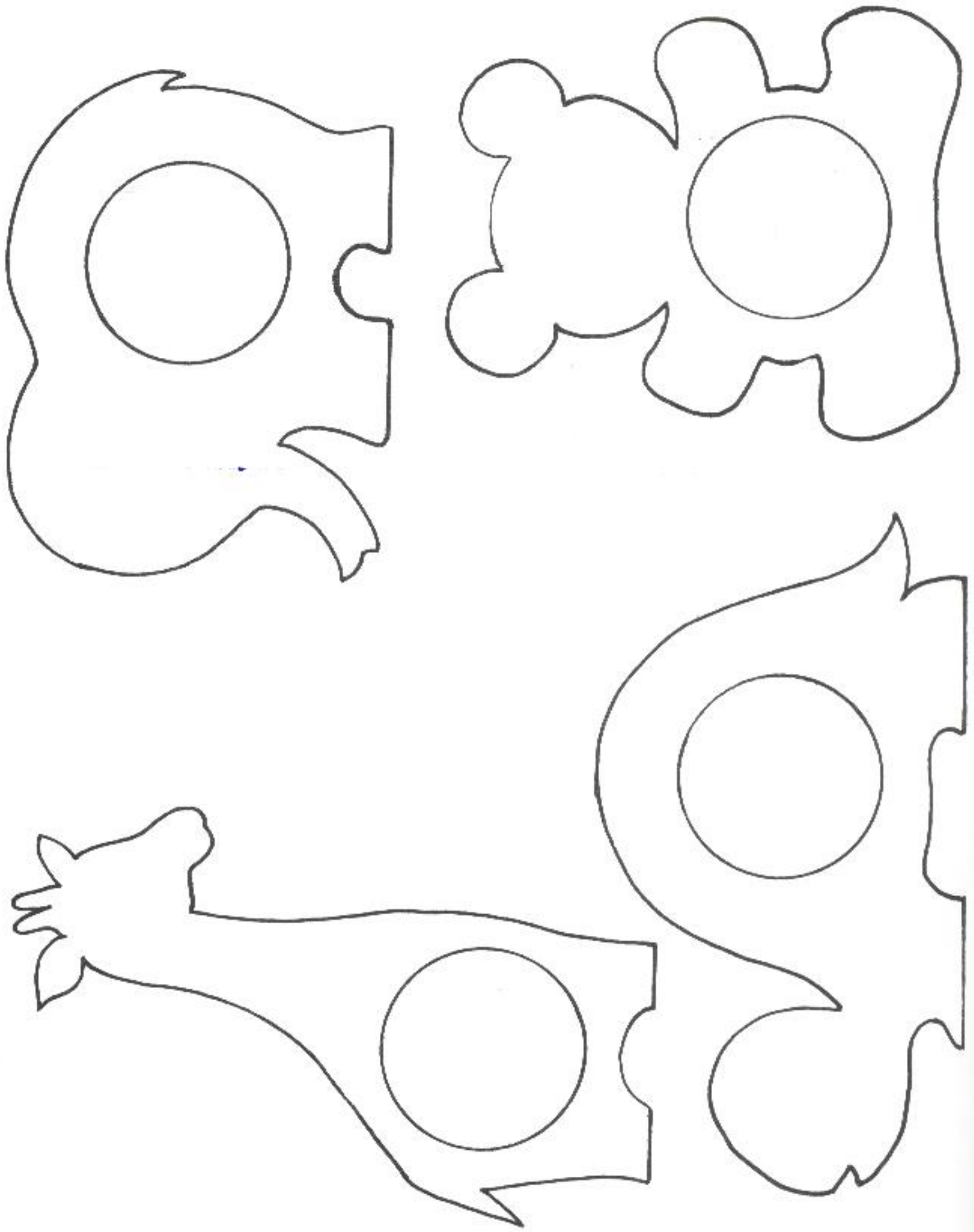



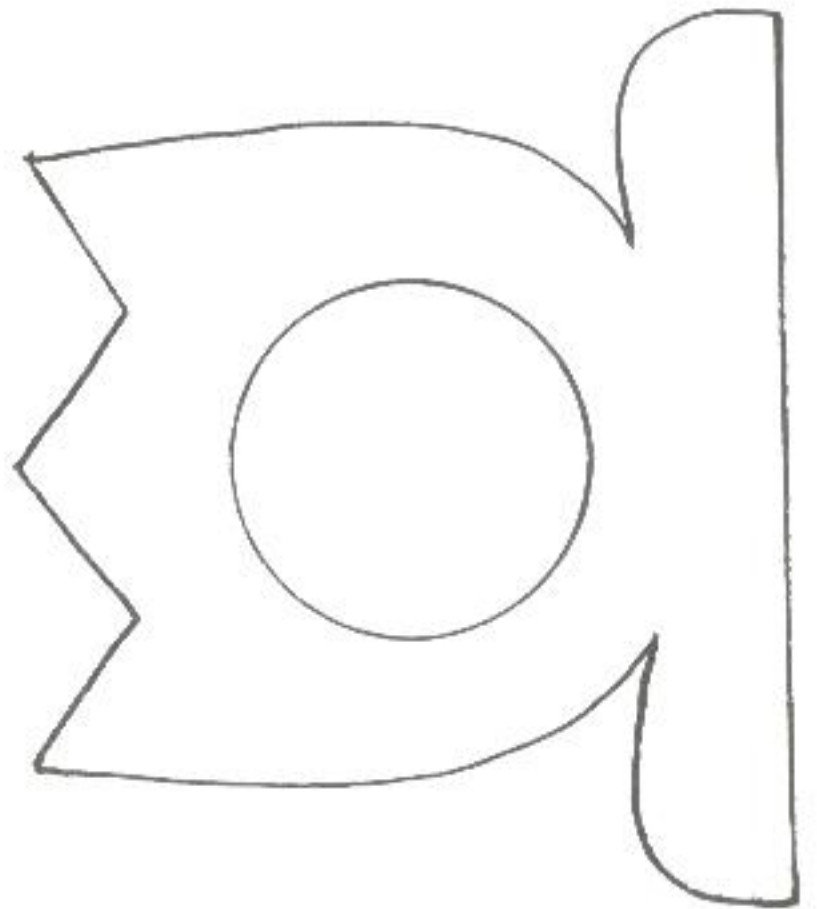
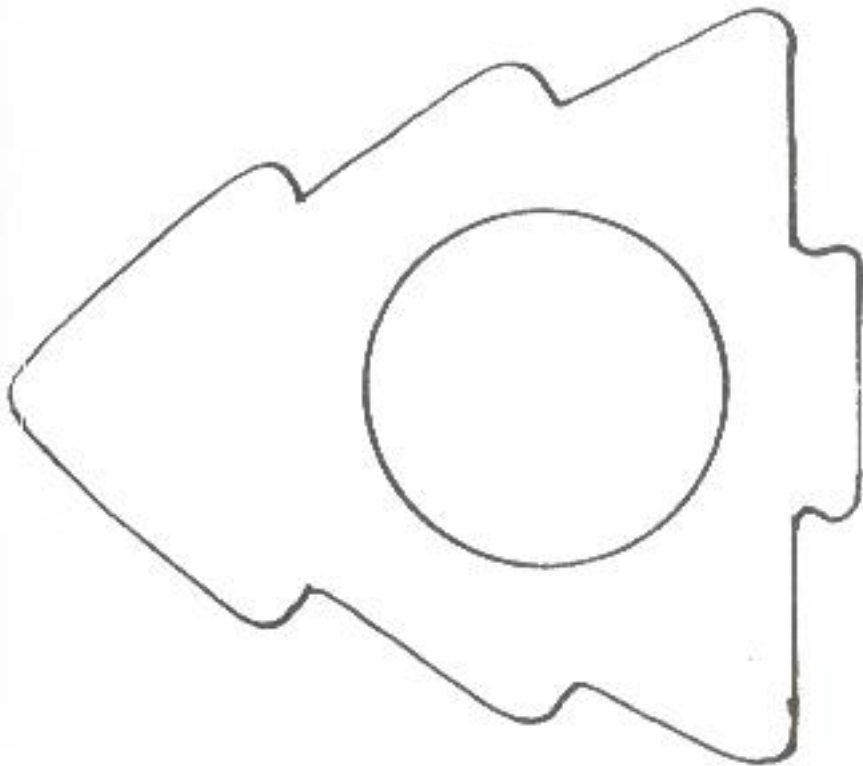
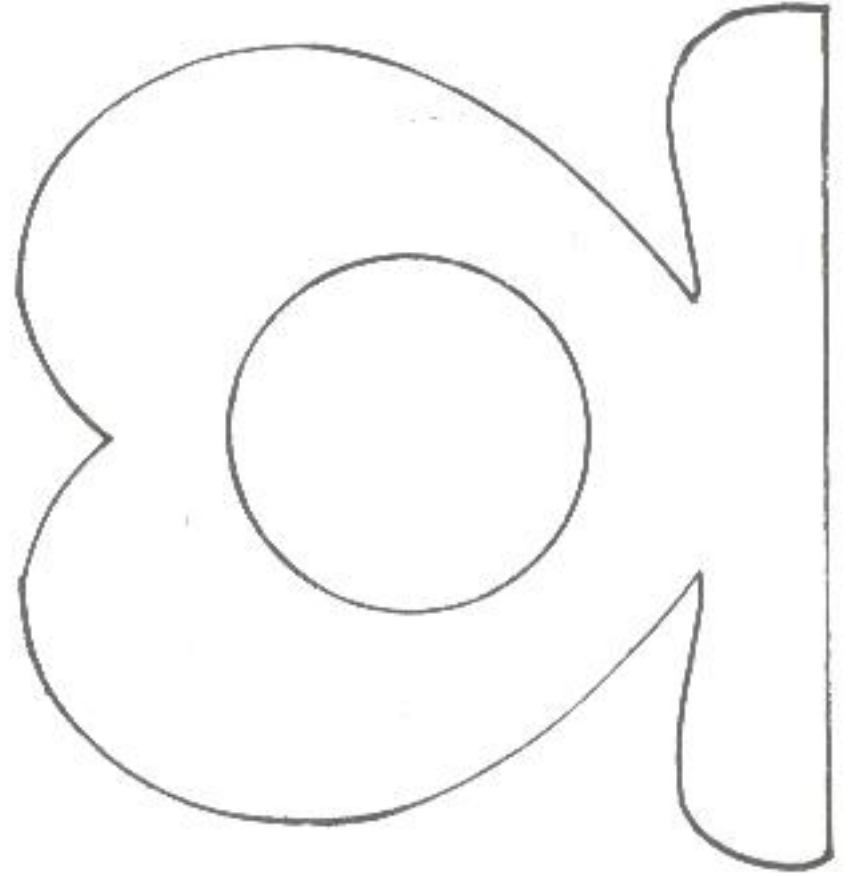
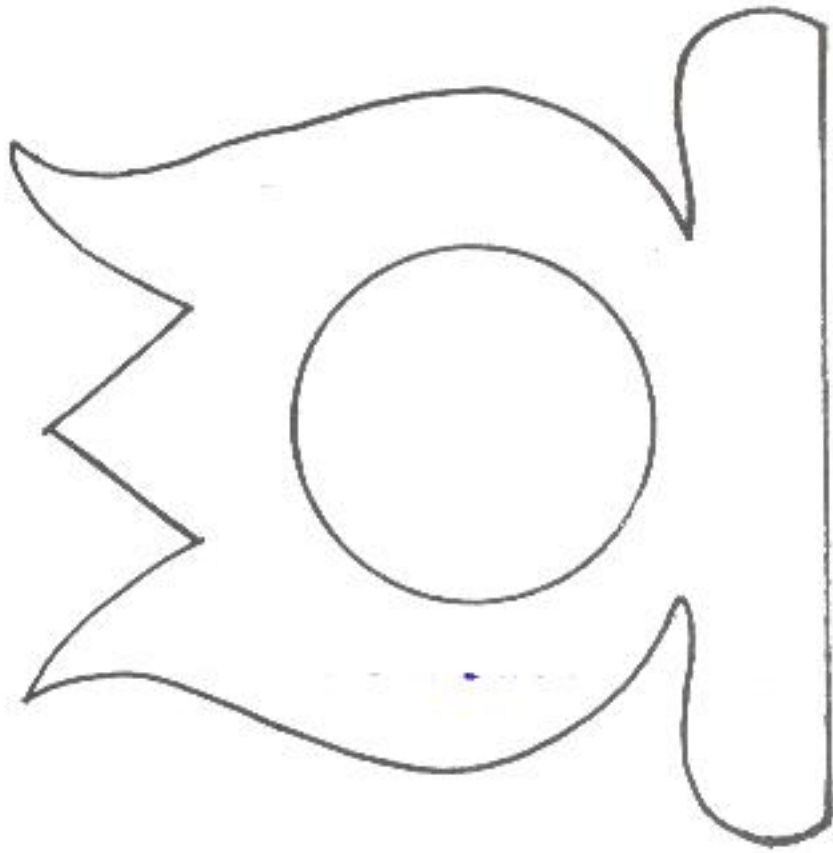

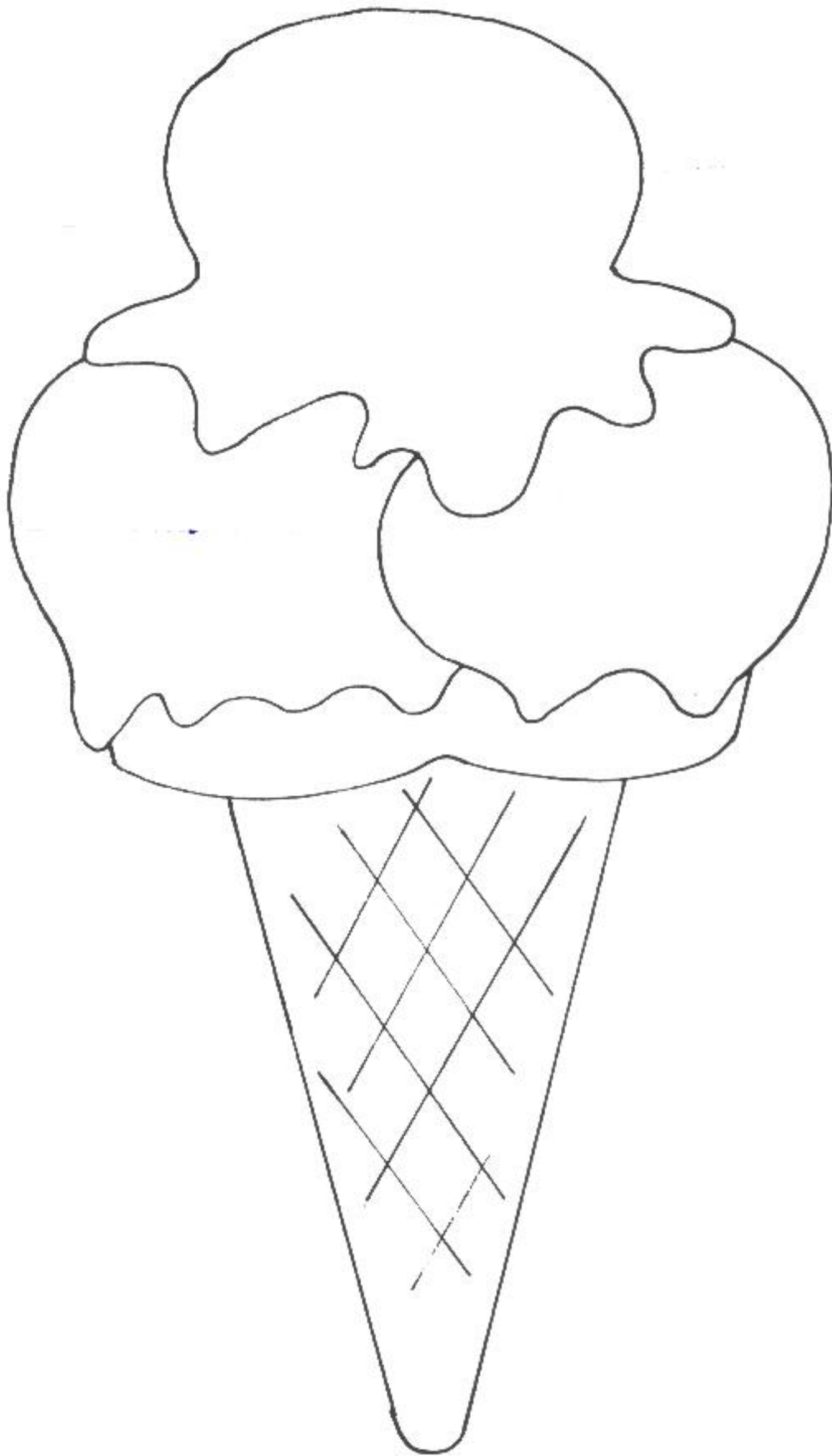







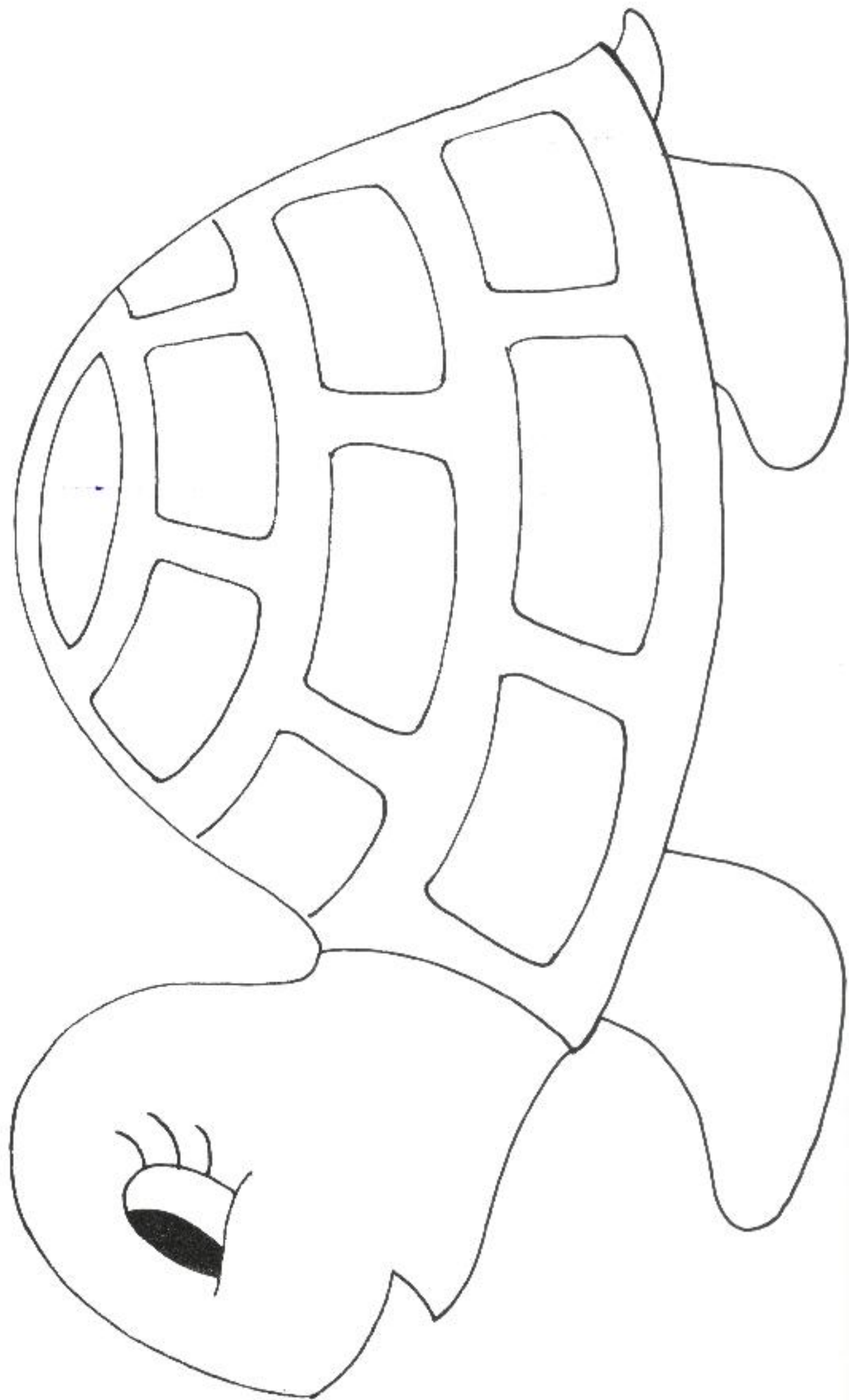



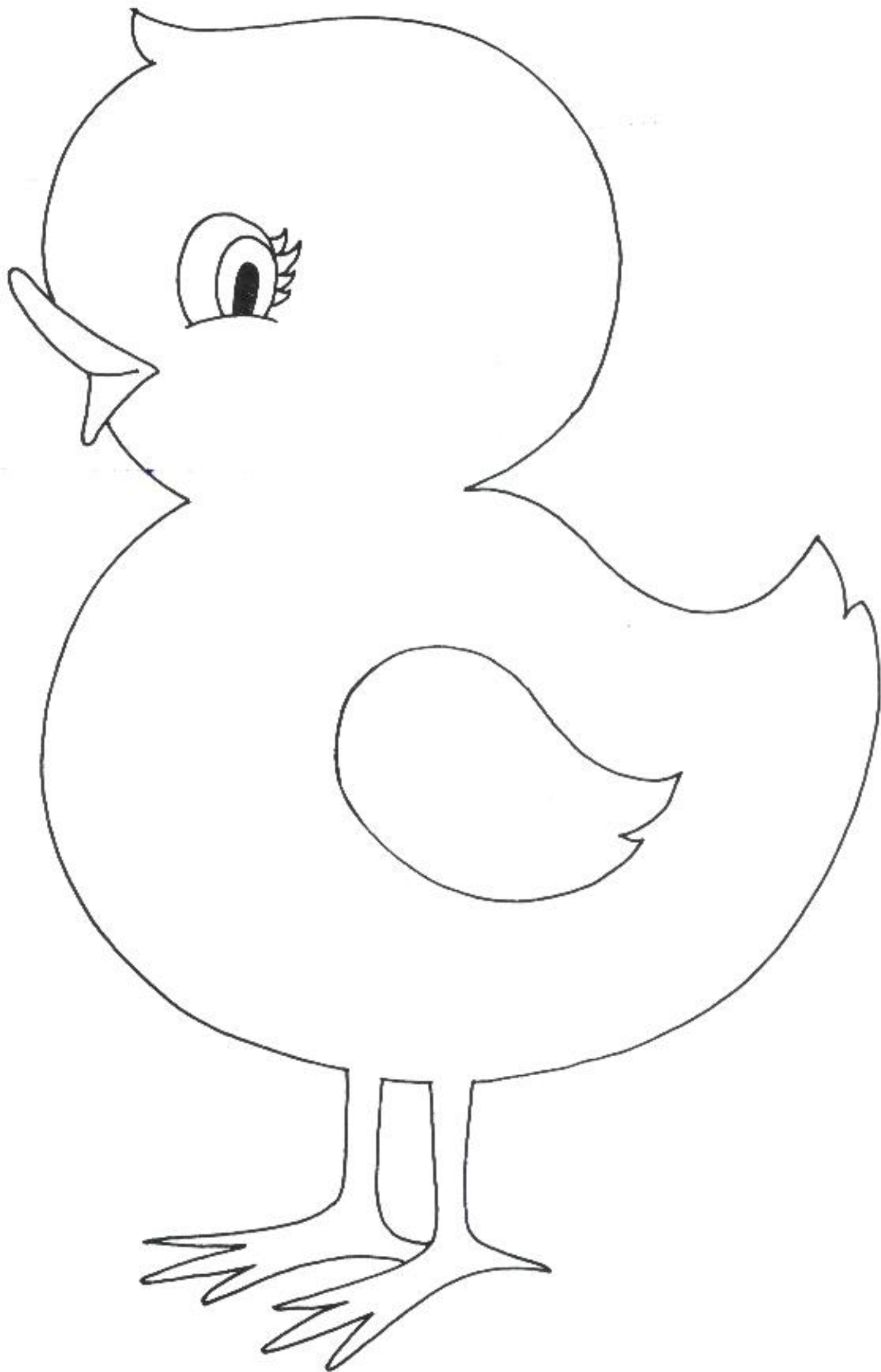



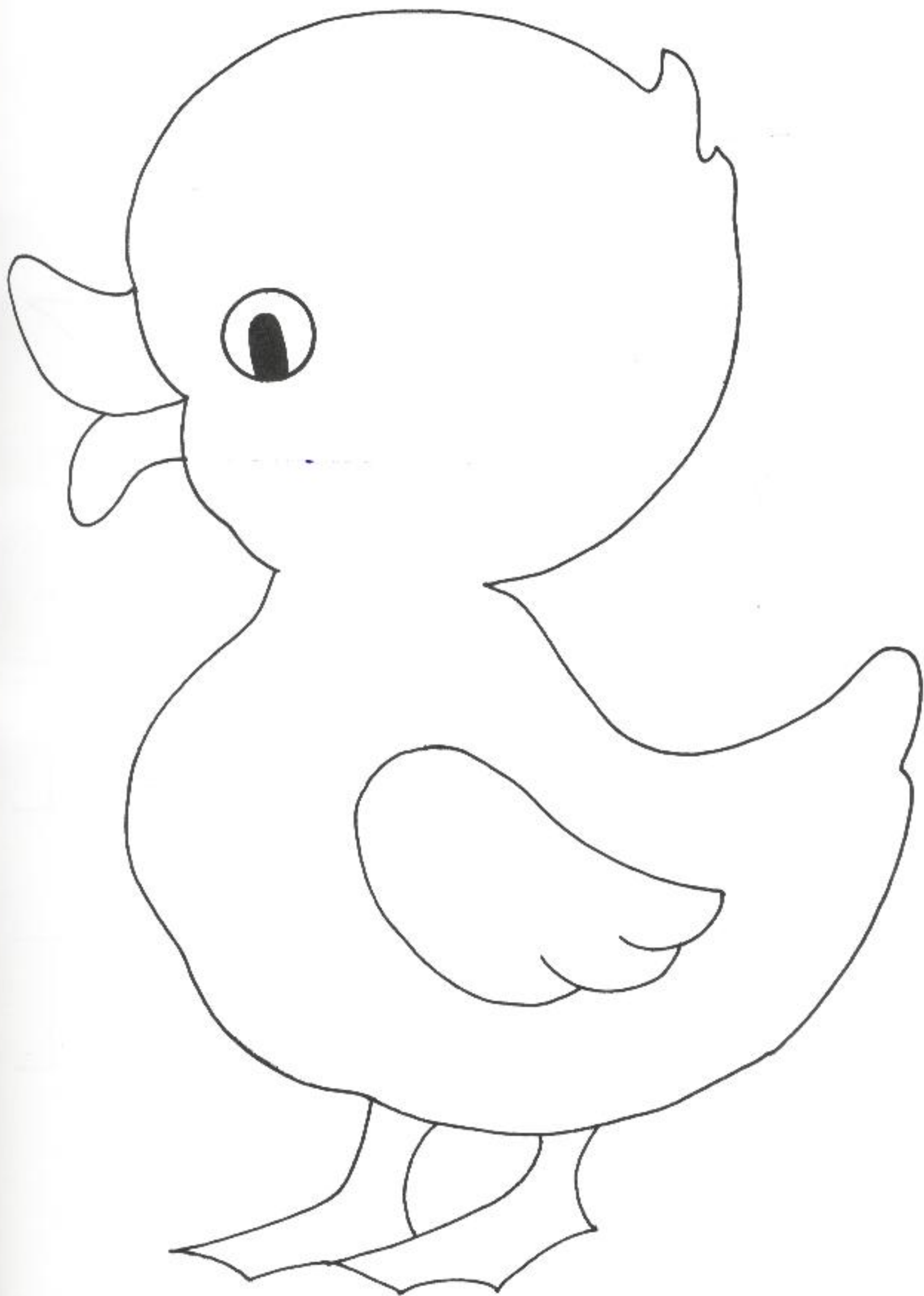

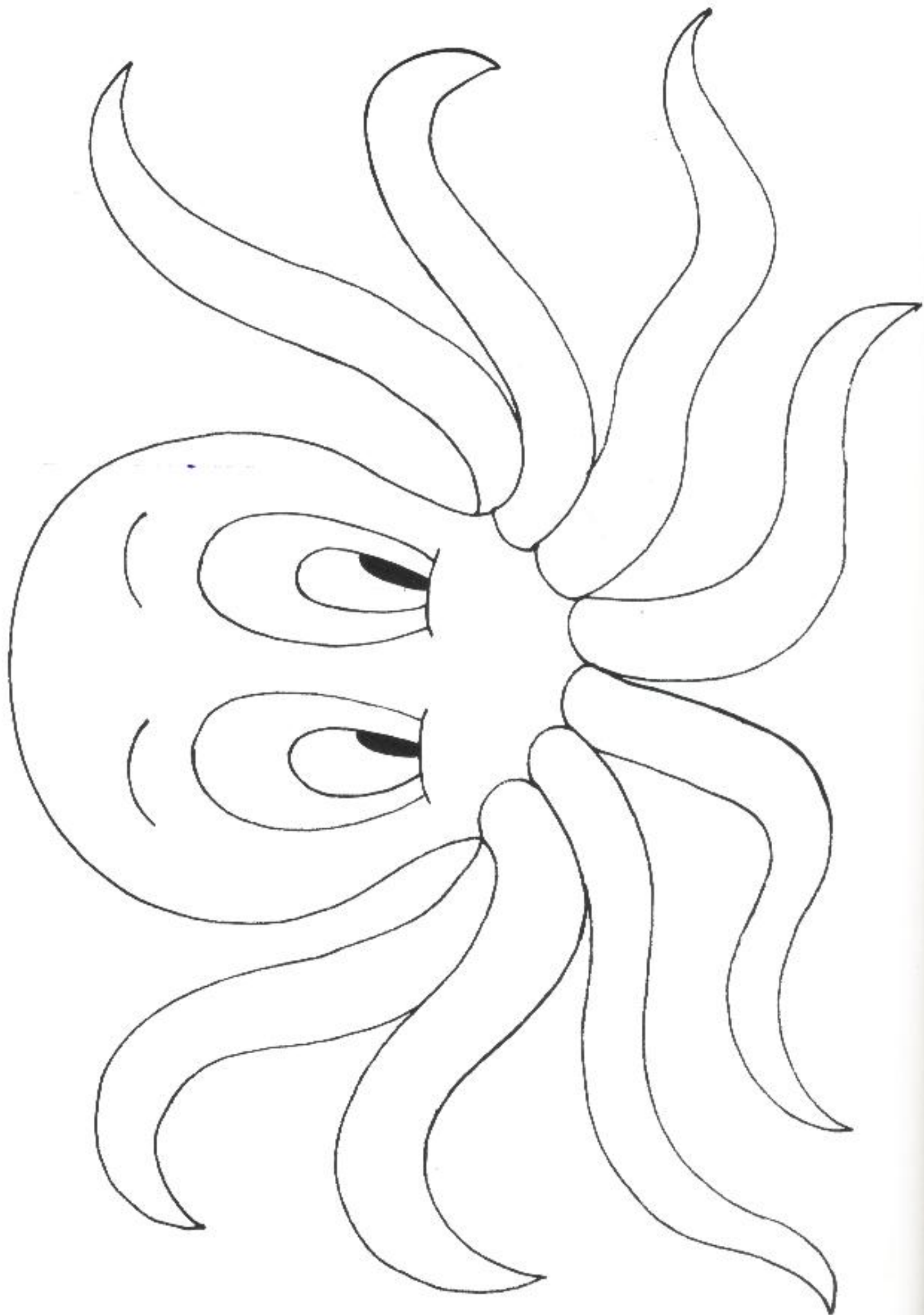

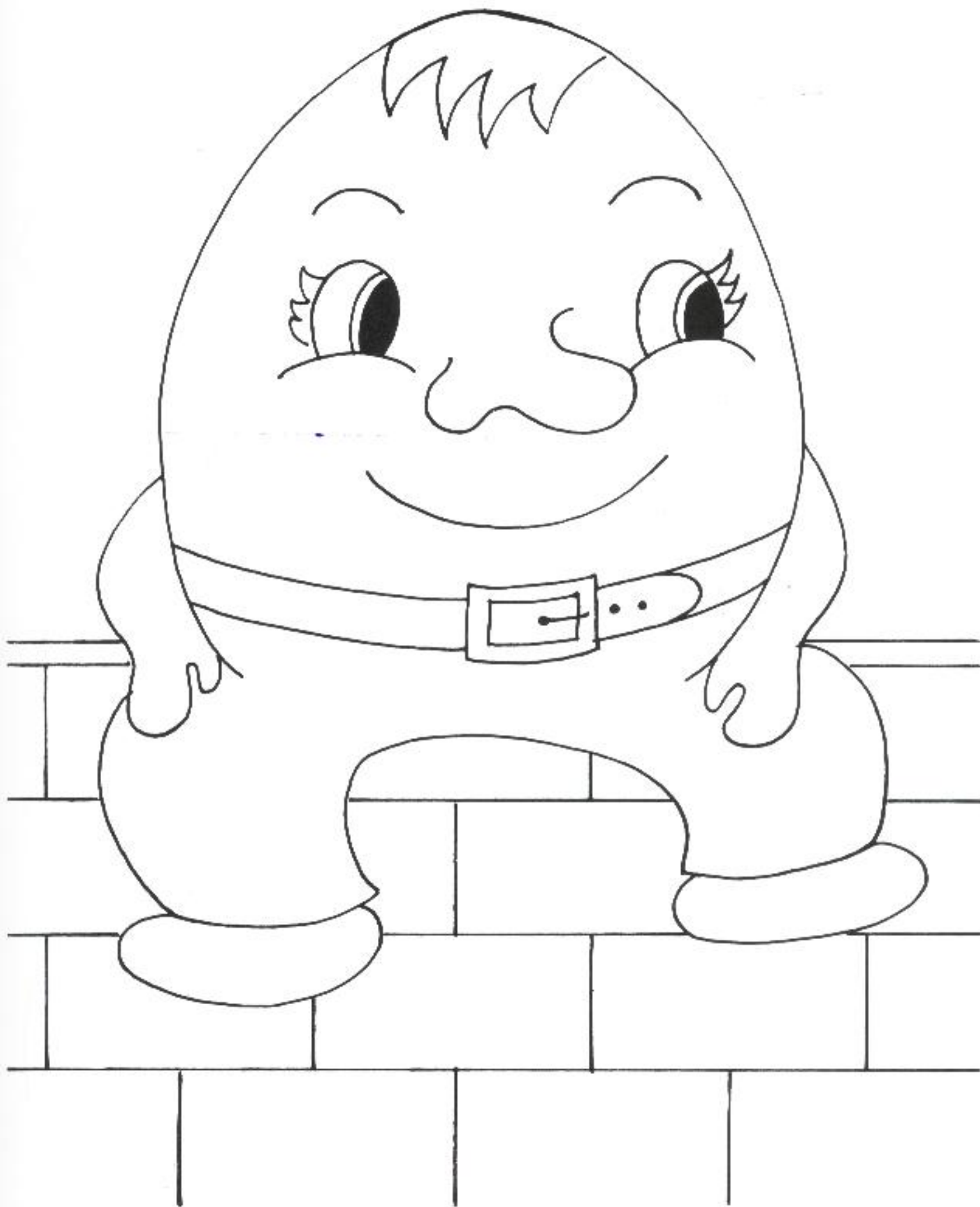

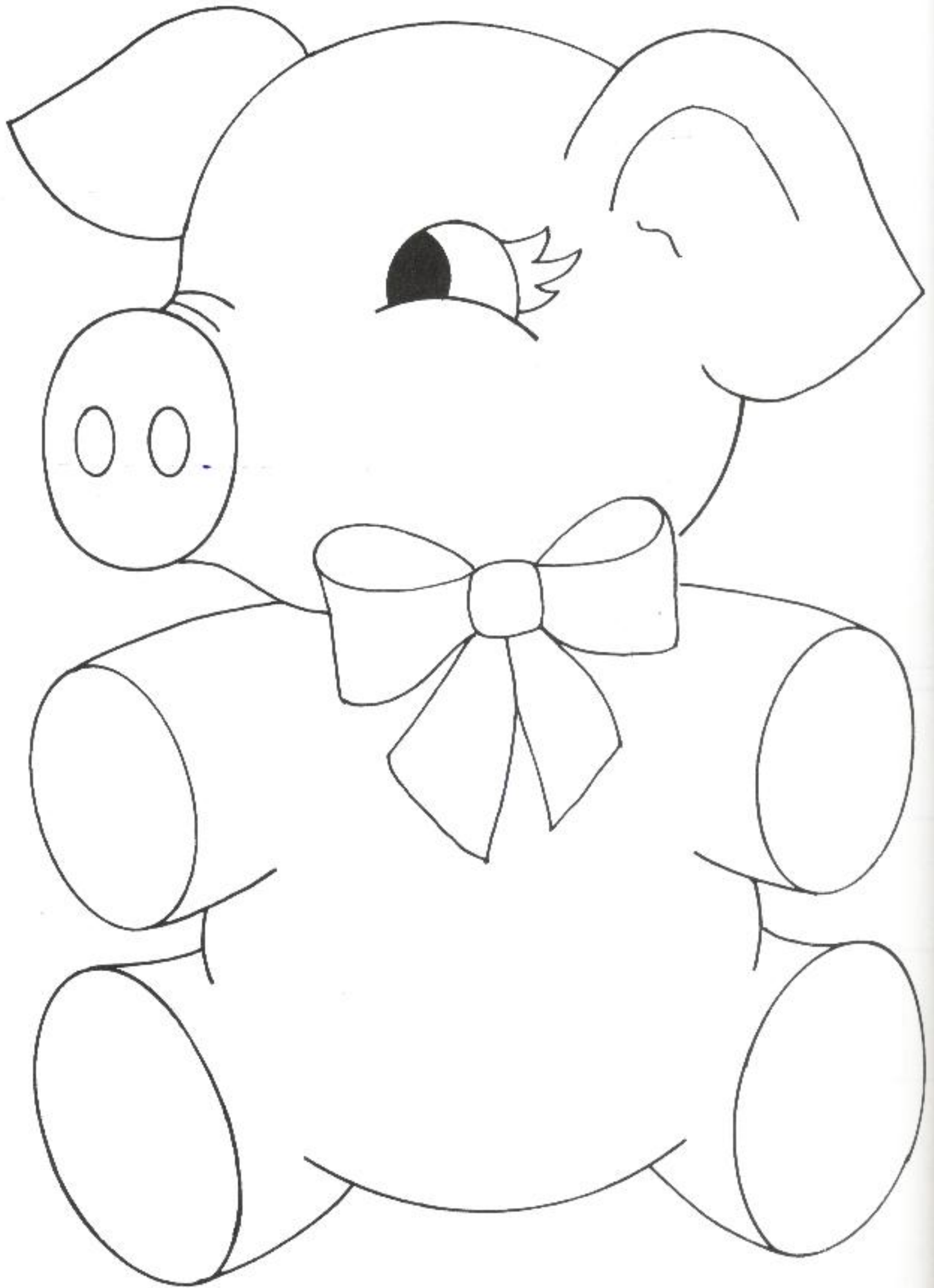

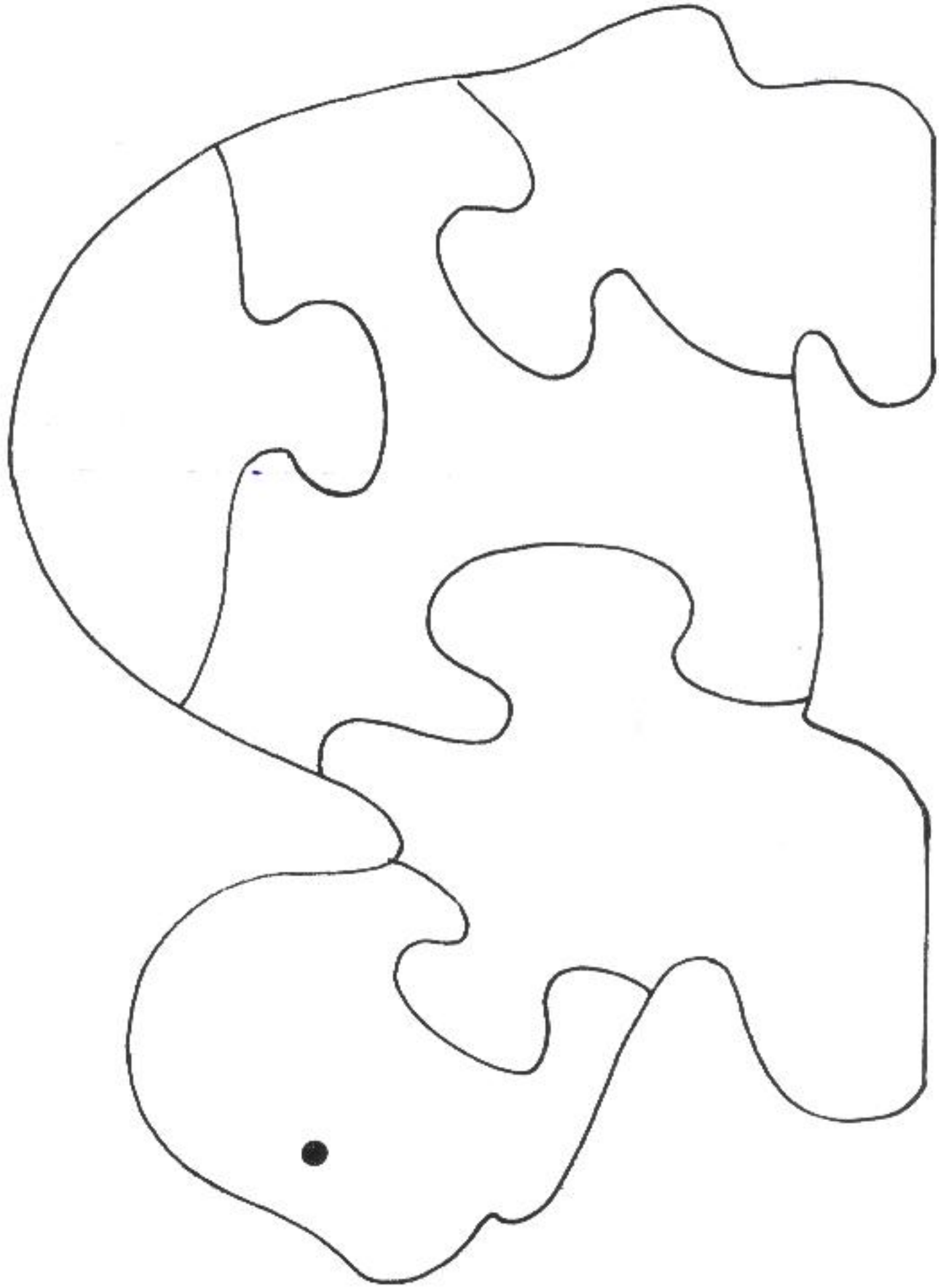

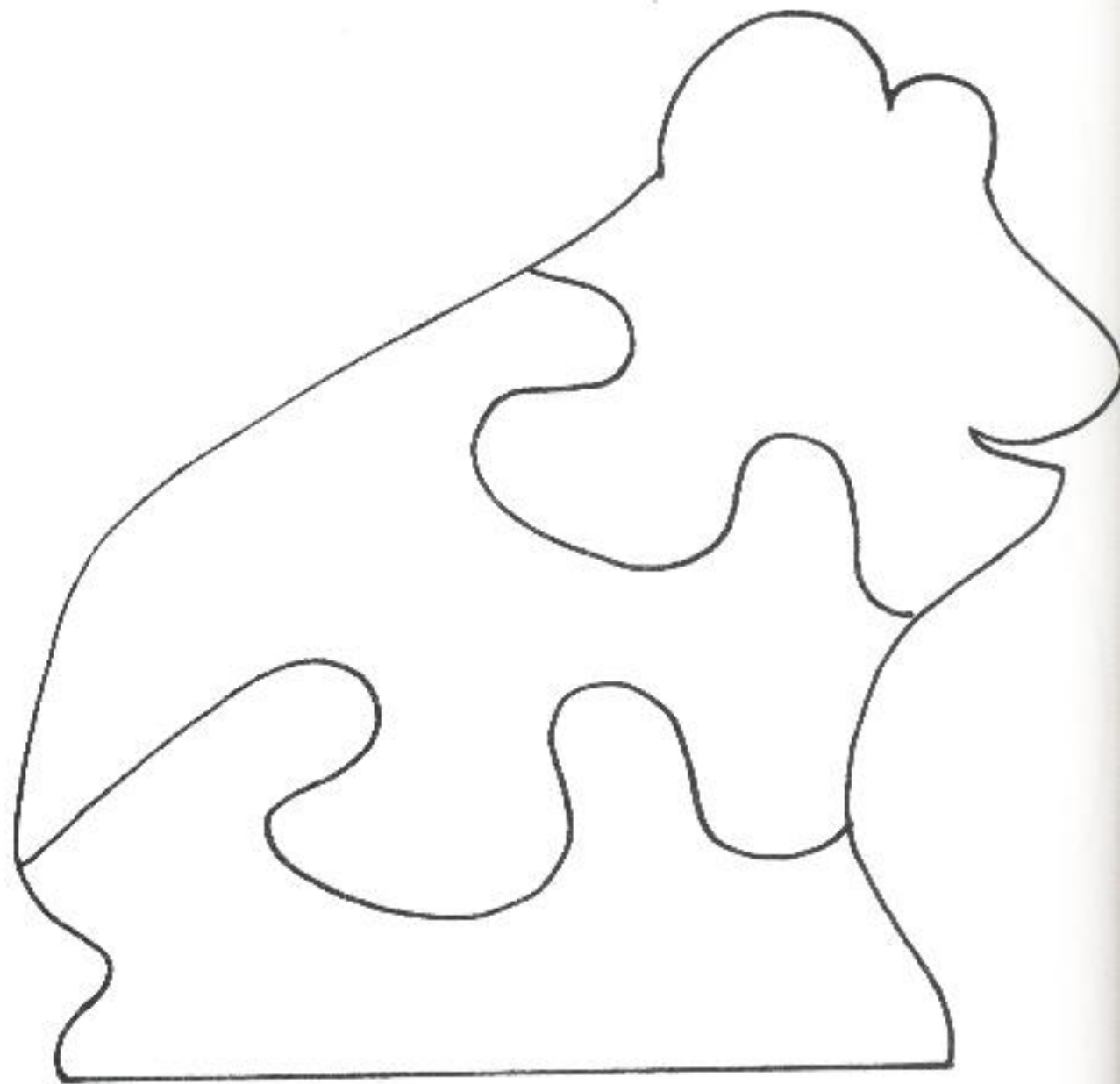
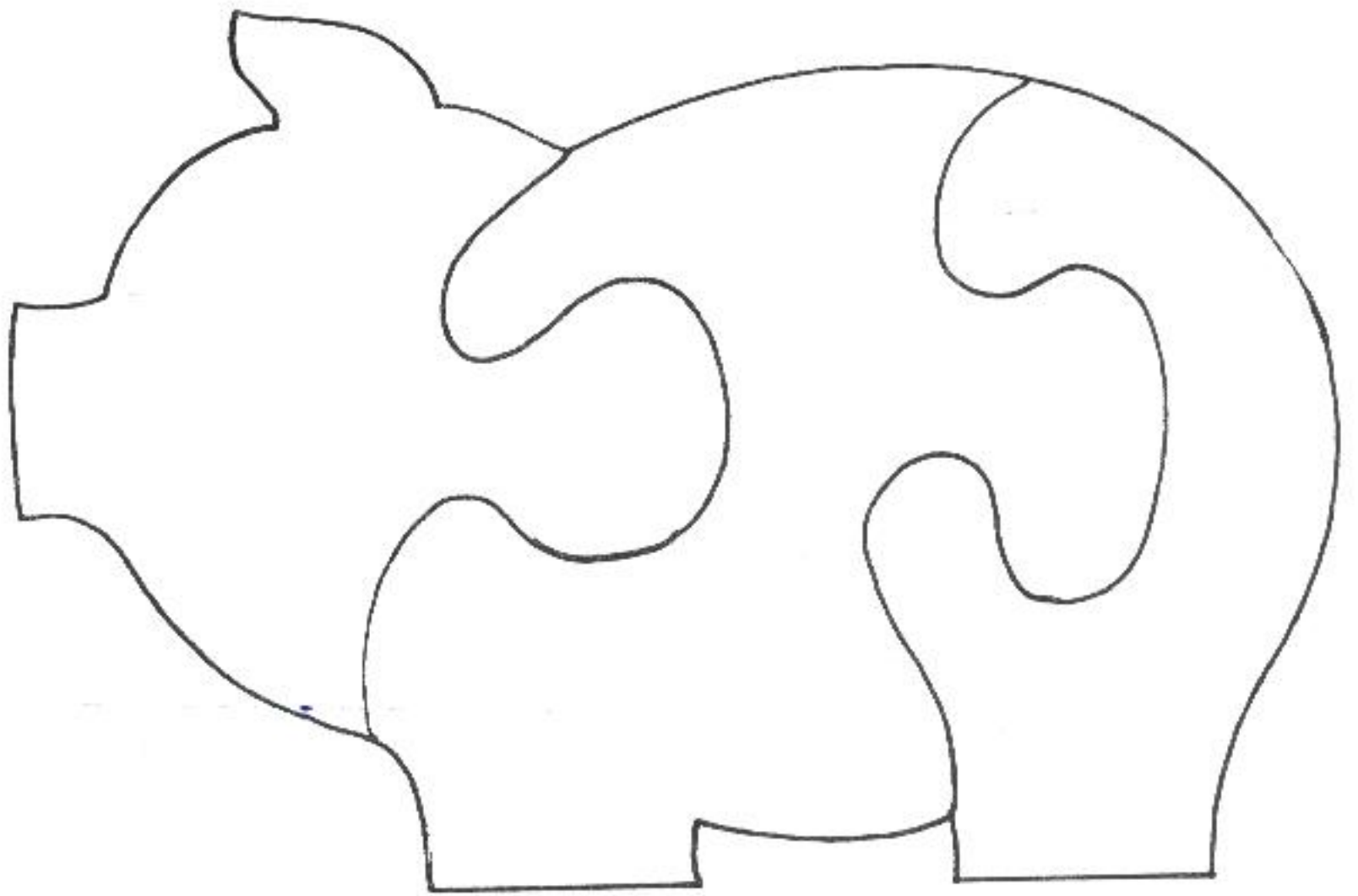

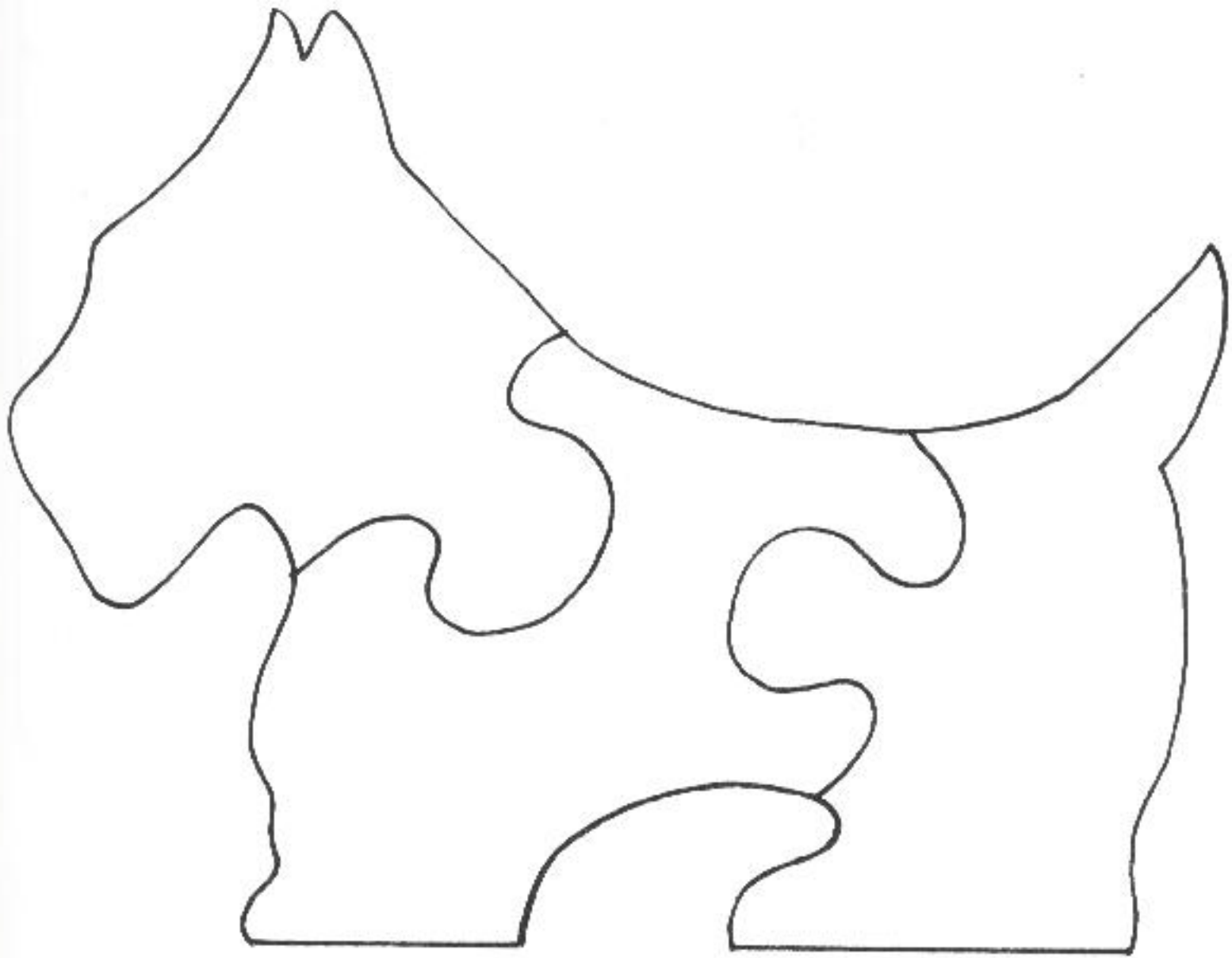
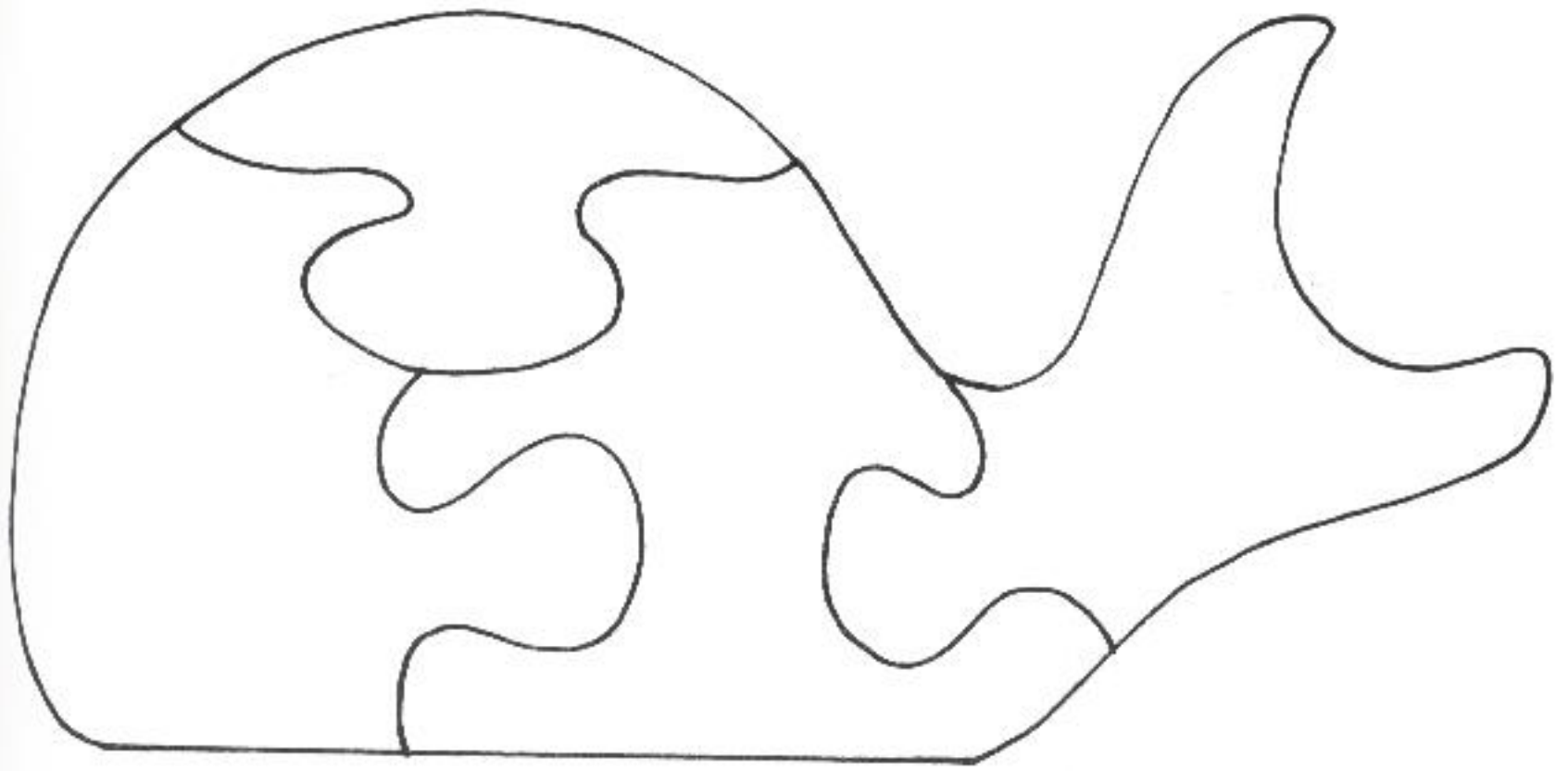

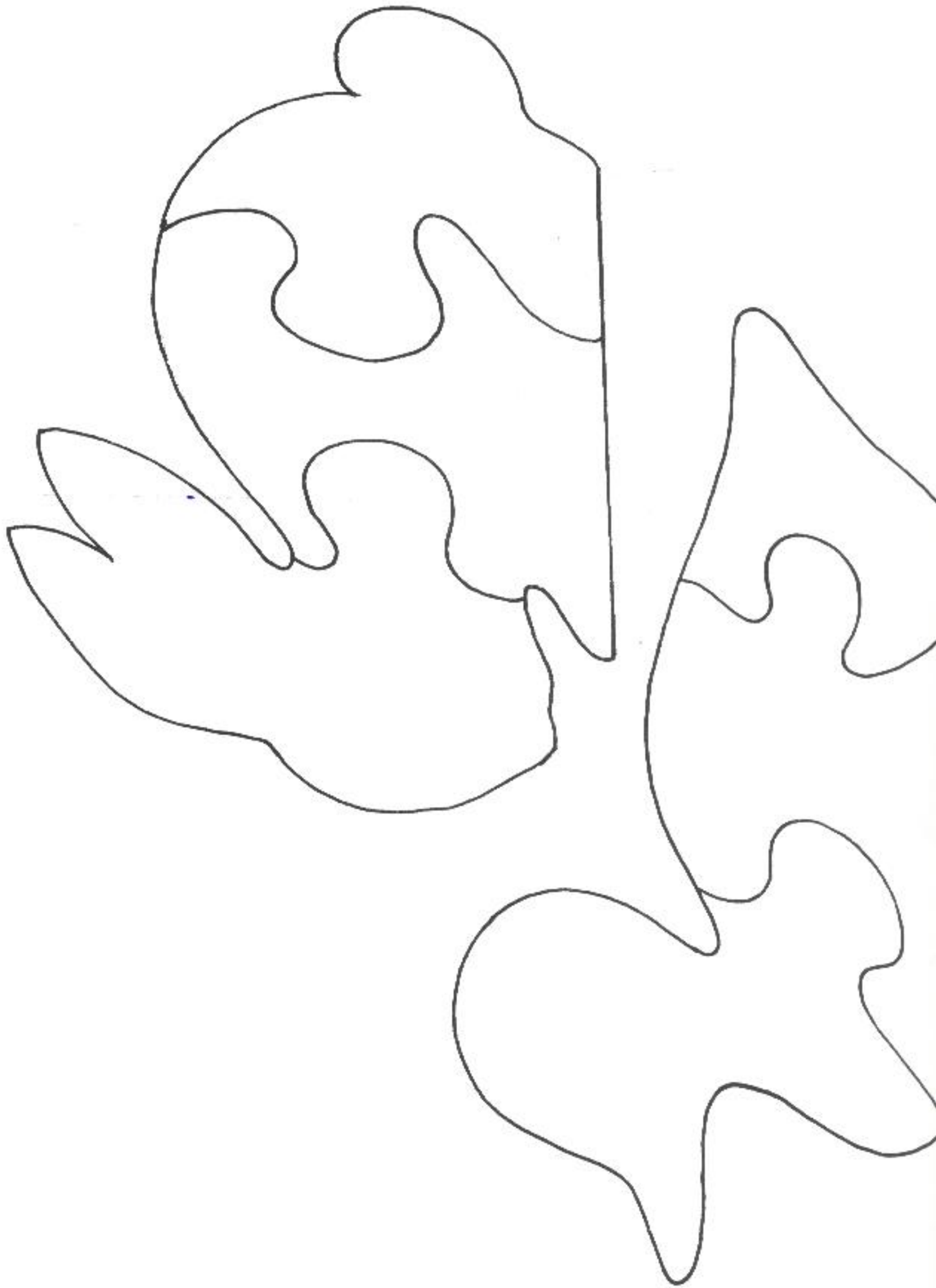



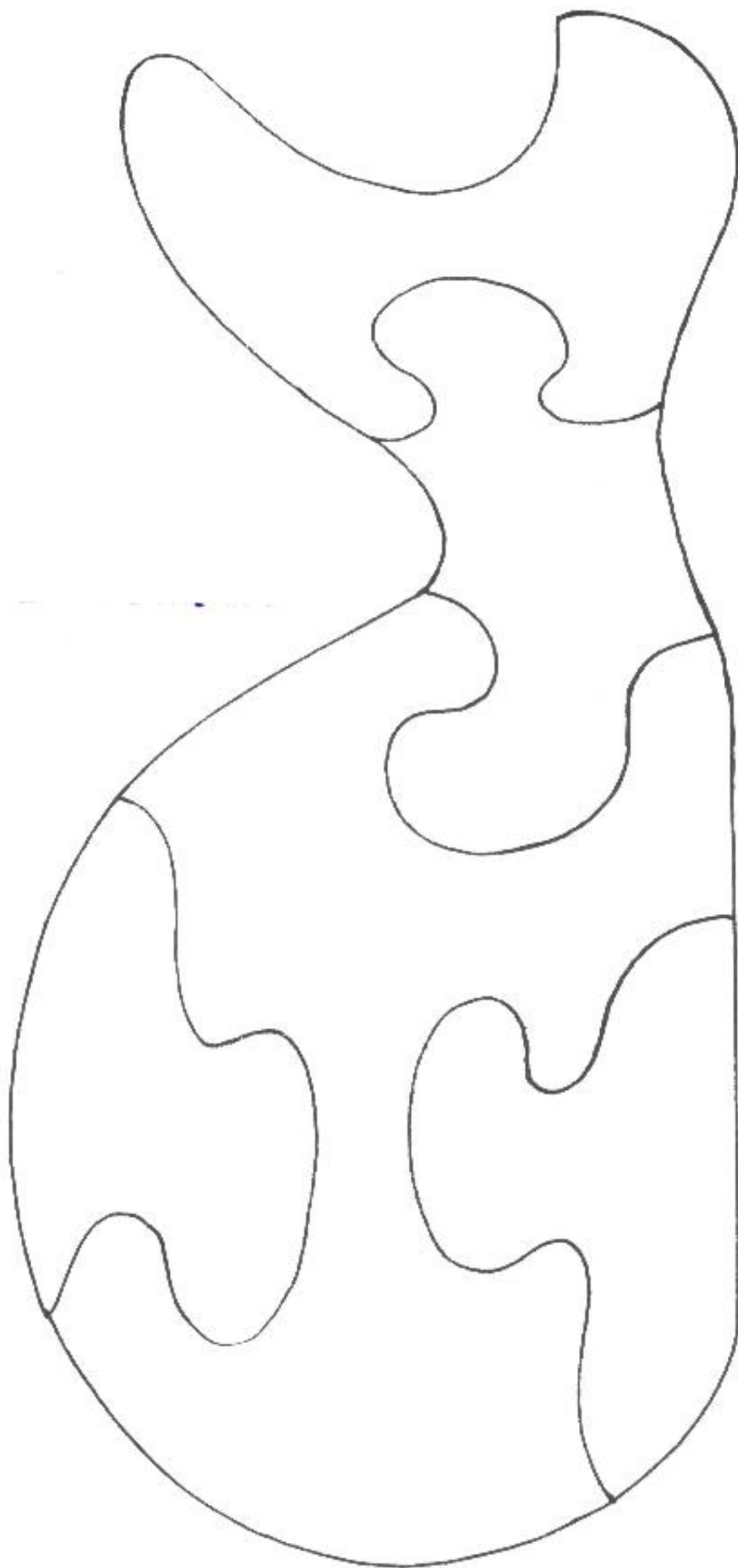

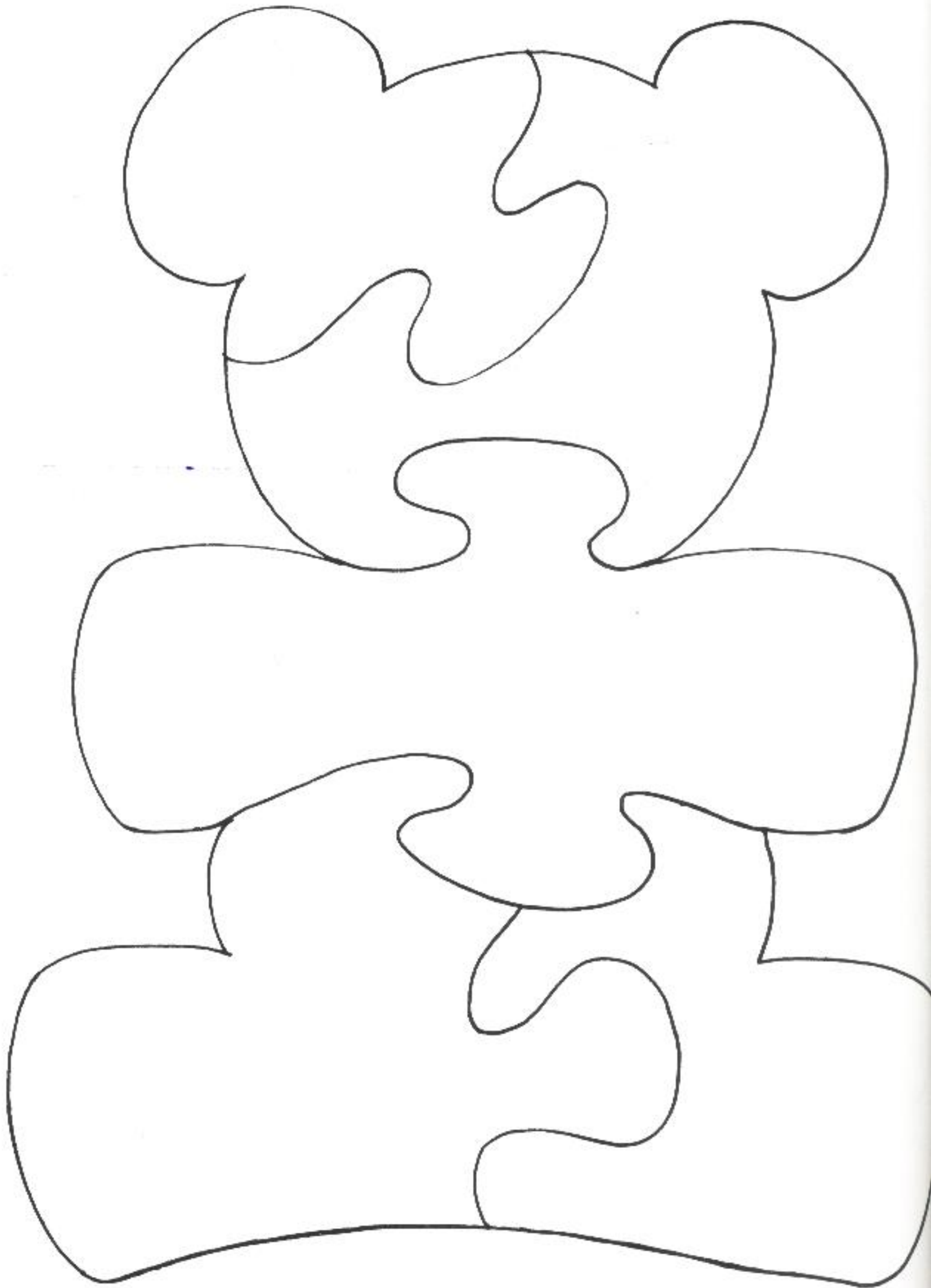

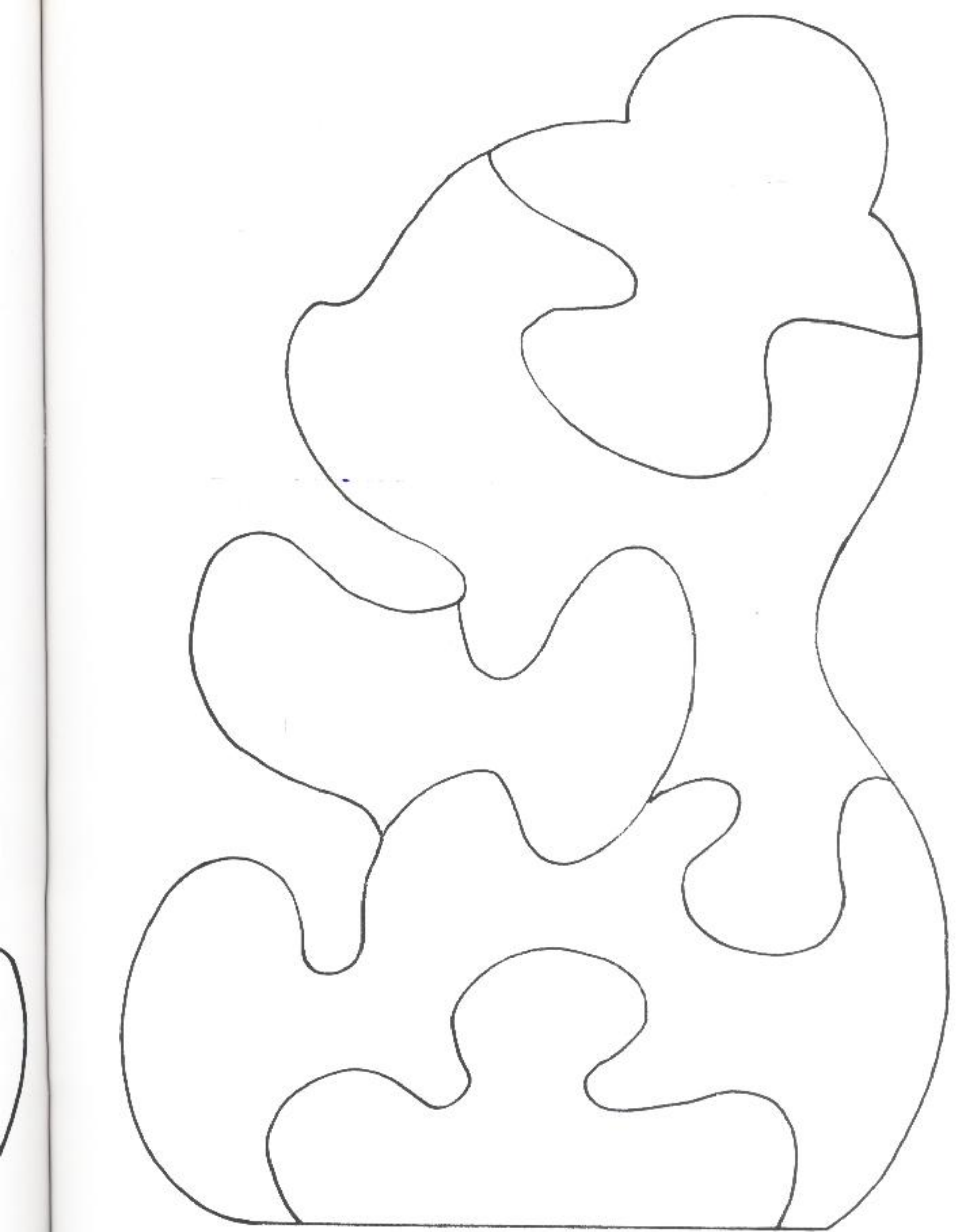

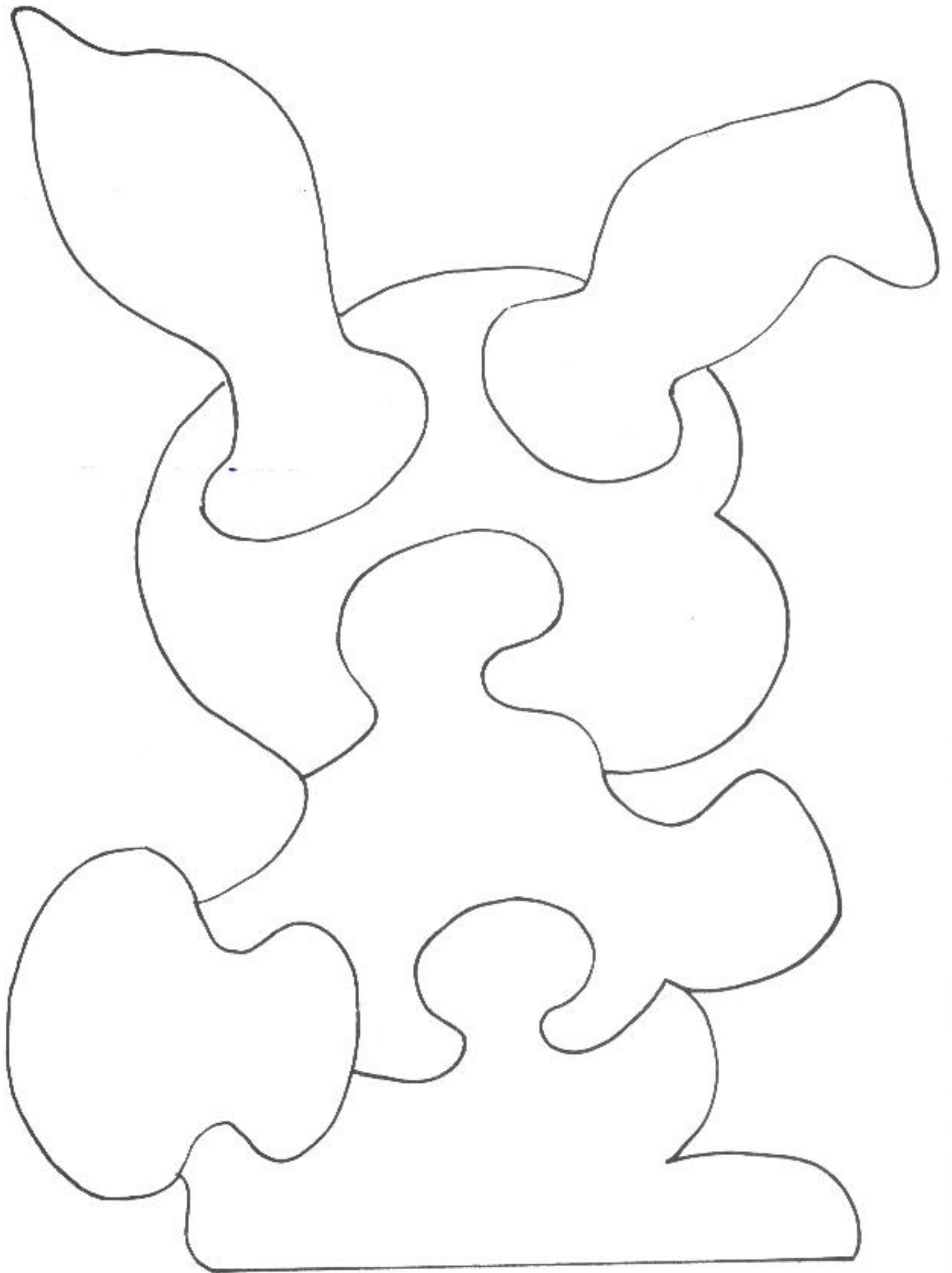

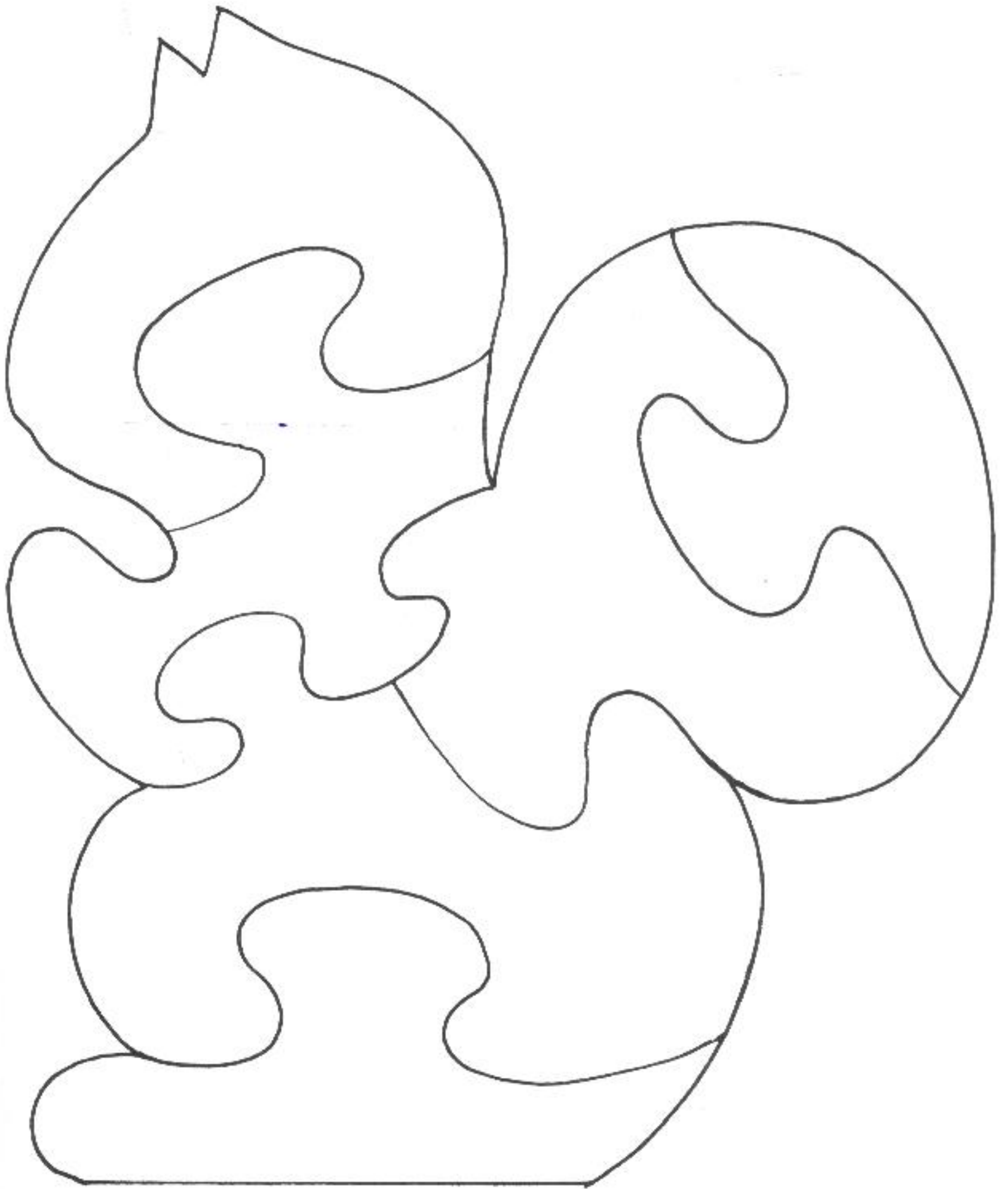

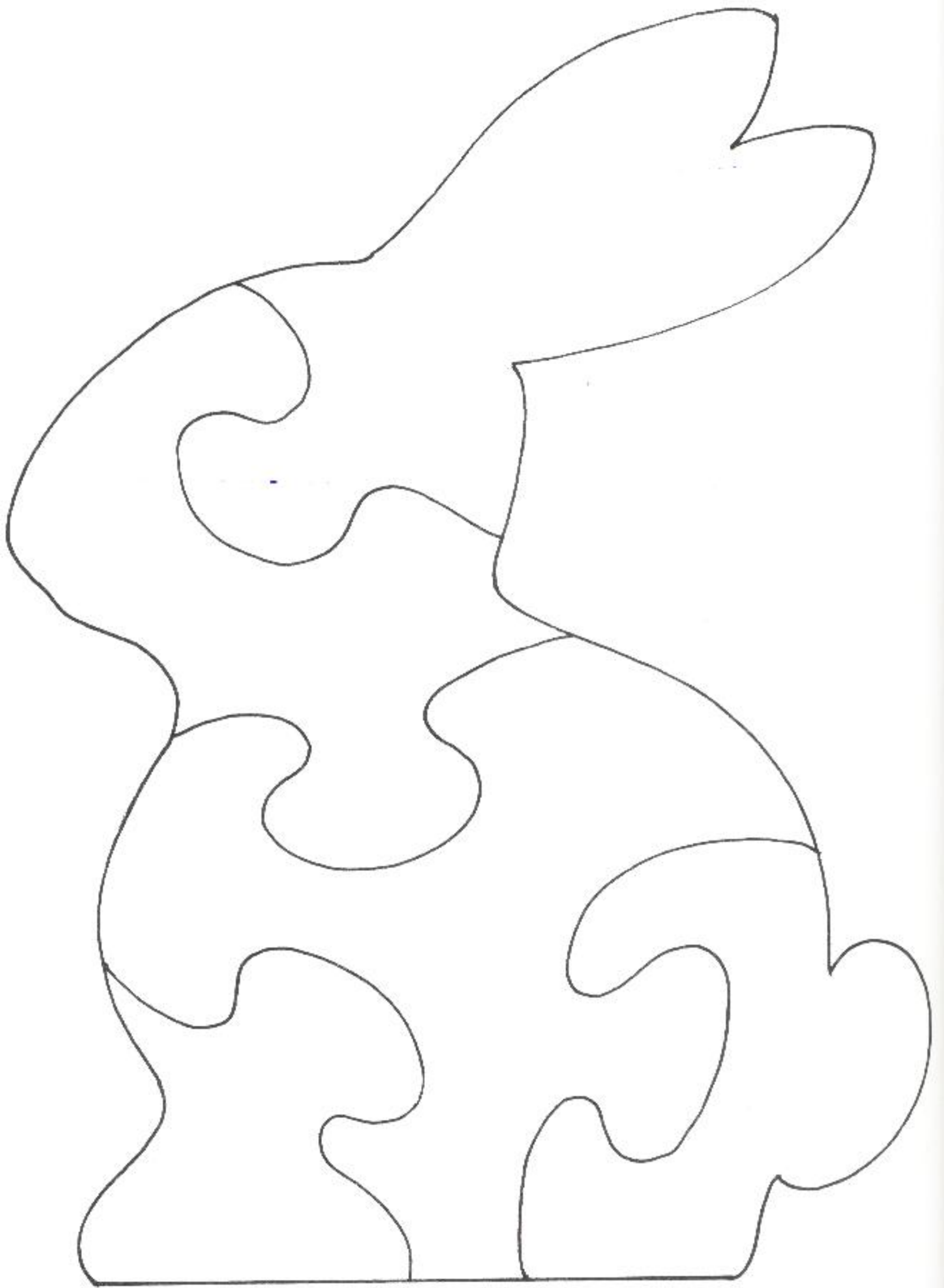

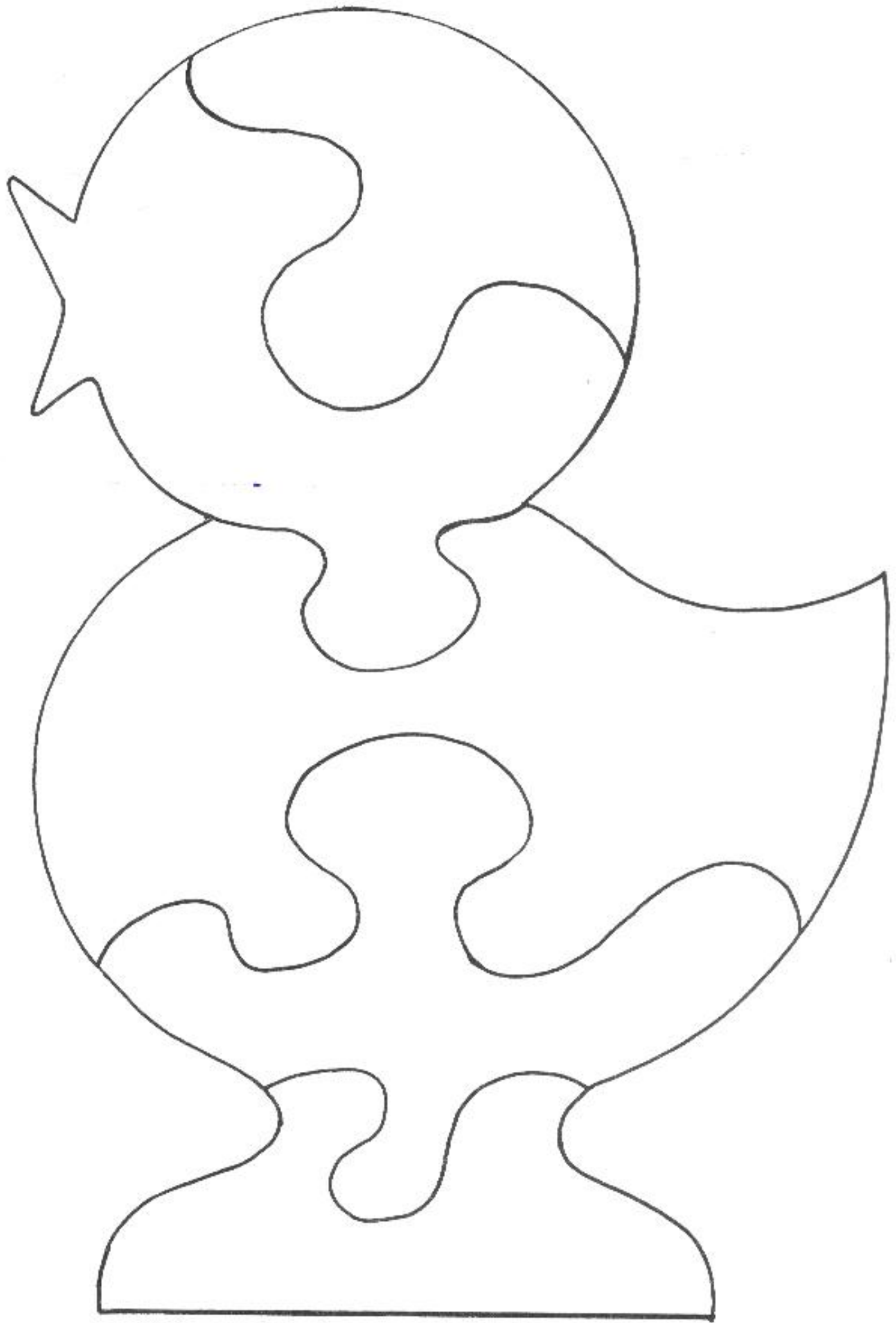

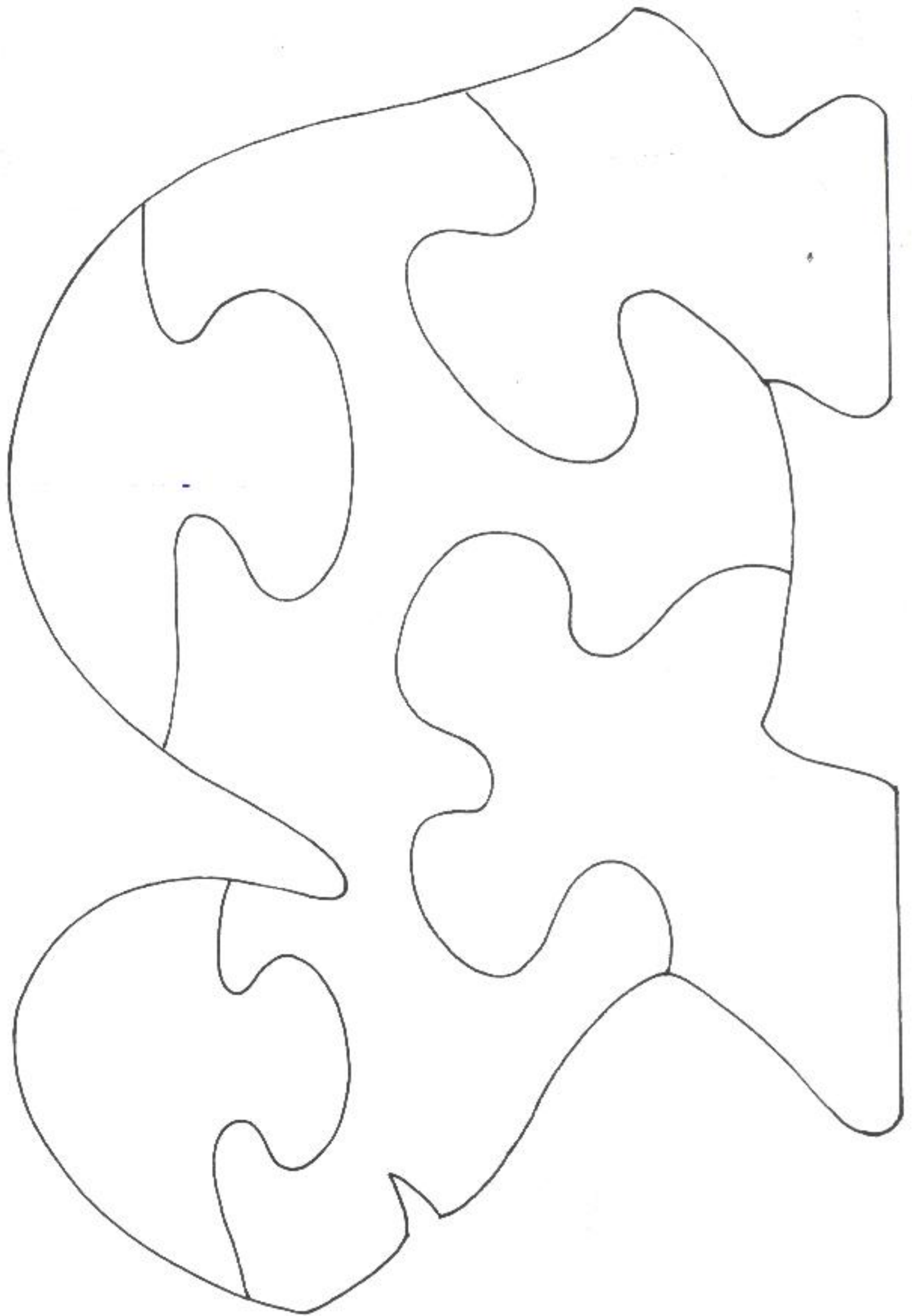



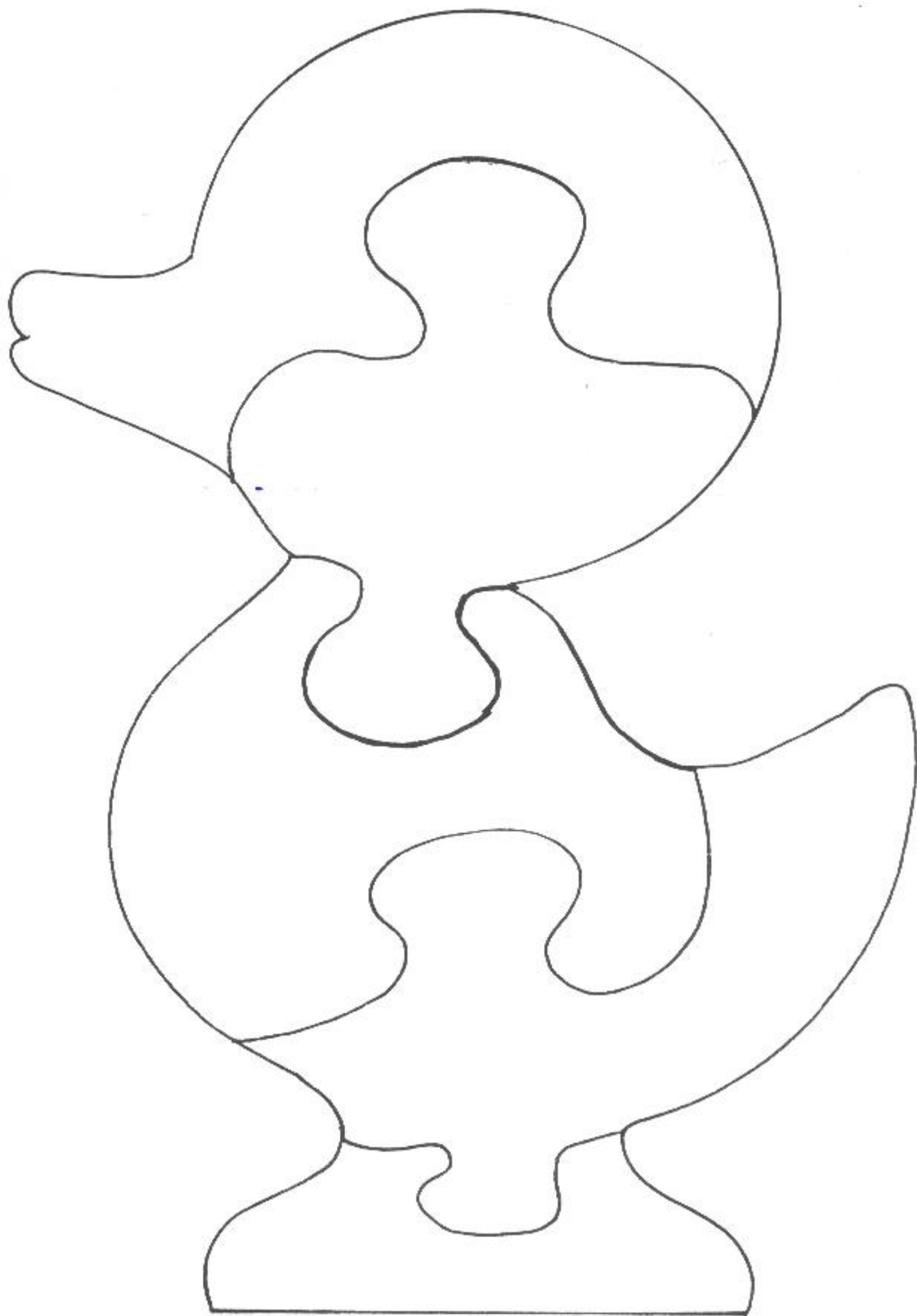

# Heart Wreath/Candle Holders

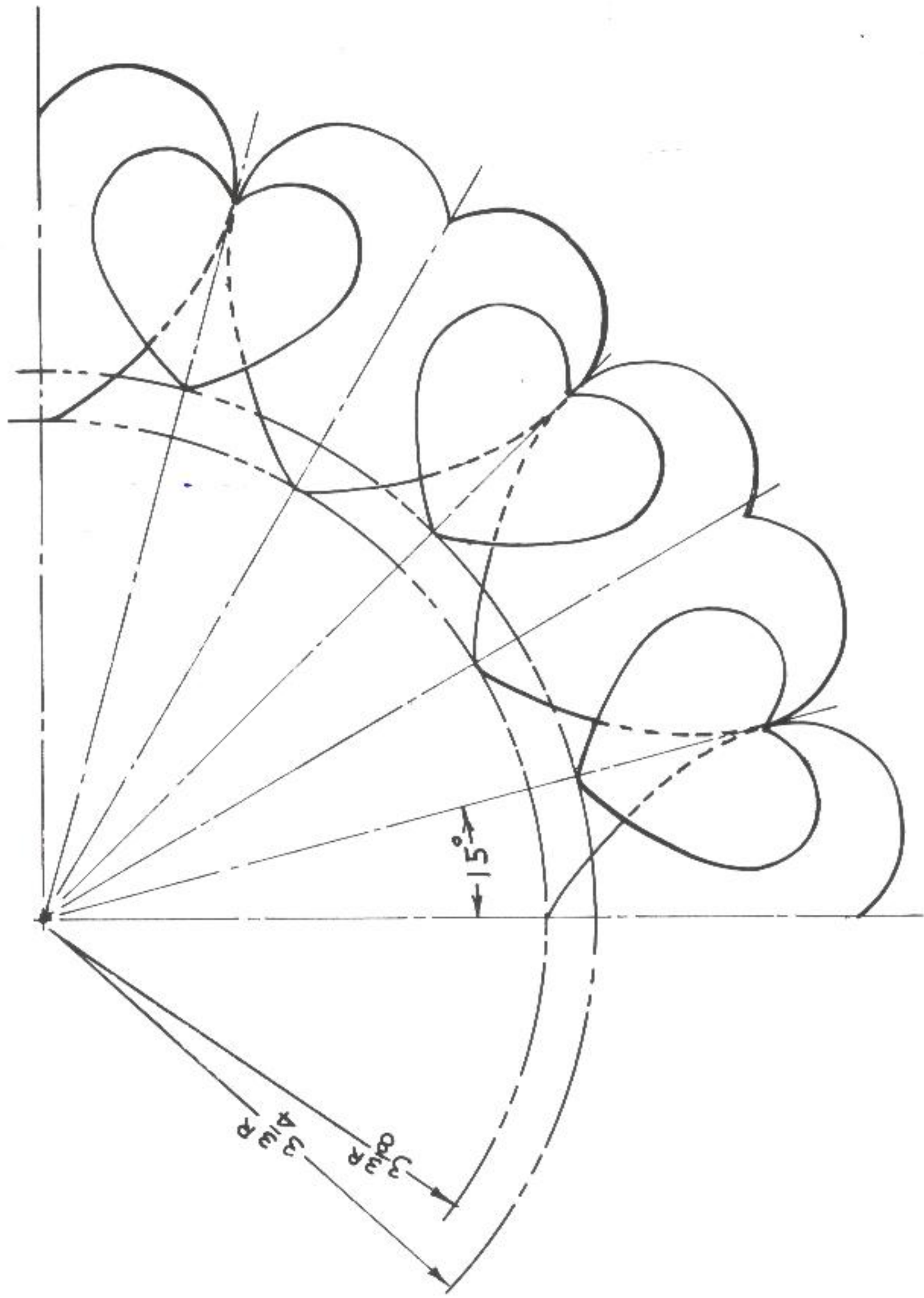

*Heart wreath and  
candle holders.*

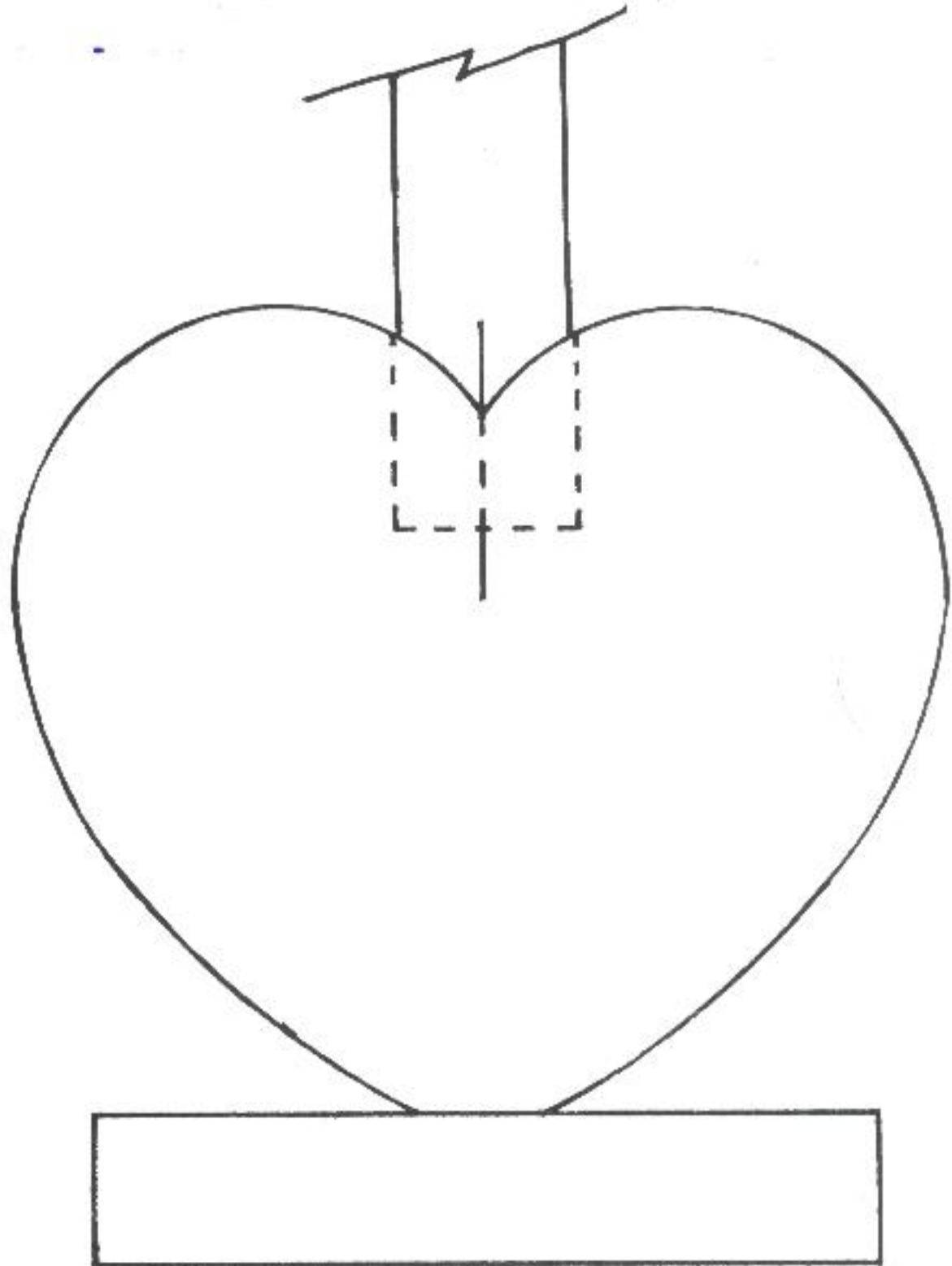
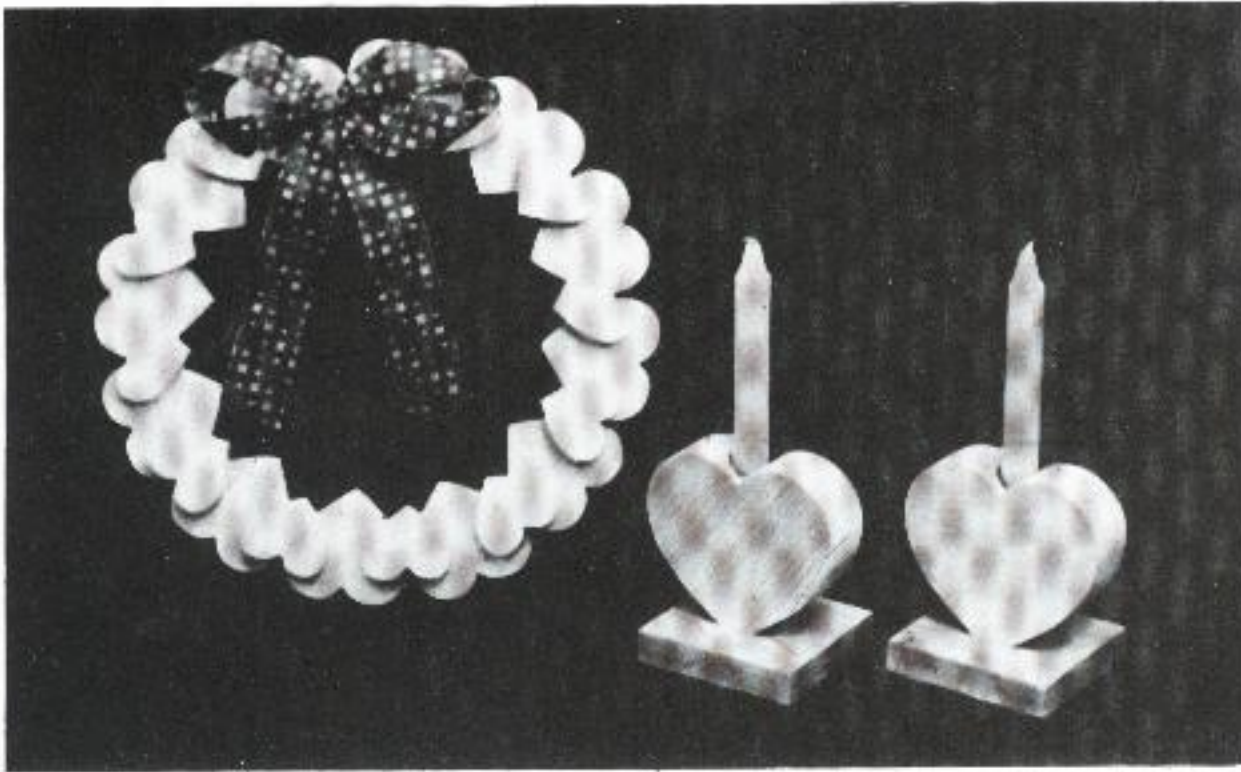

## Jewelry/Ornaments



*These items of jewelry were made from brass and 1/8-inch-thick exotic hardwoods. The key chains were made from 1/4-inch plywood.*

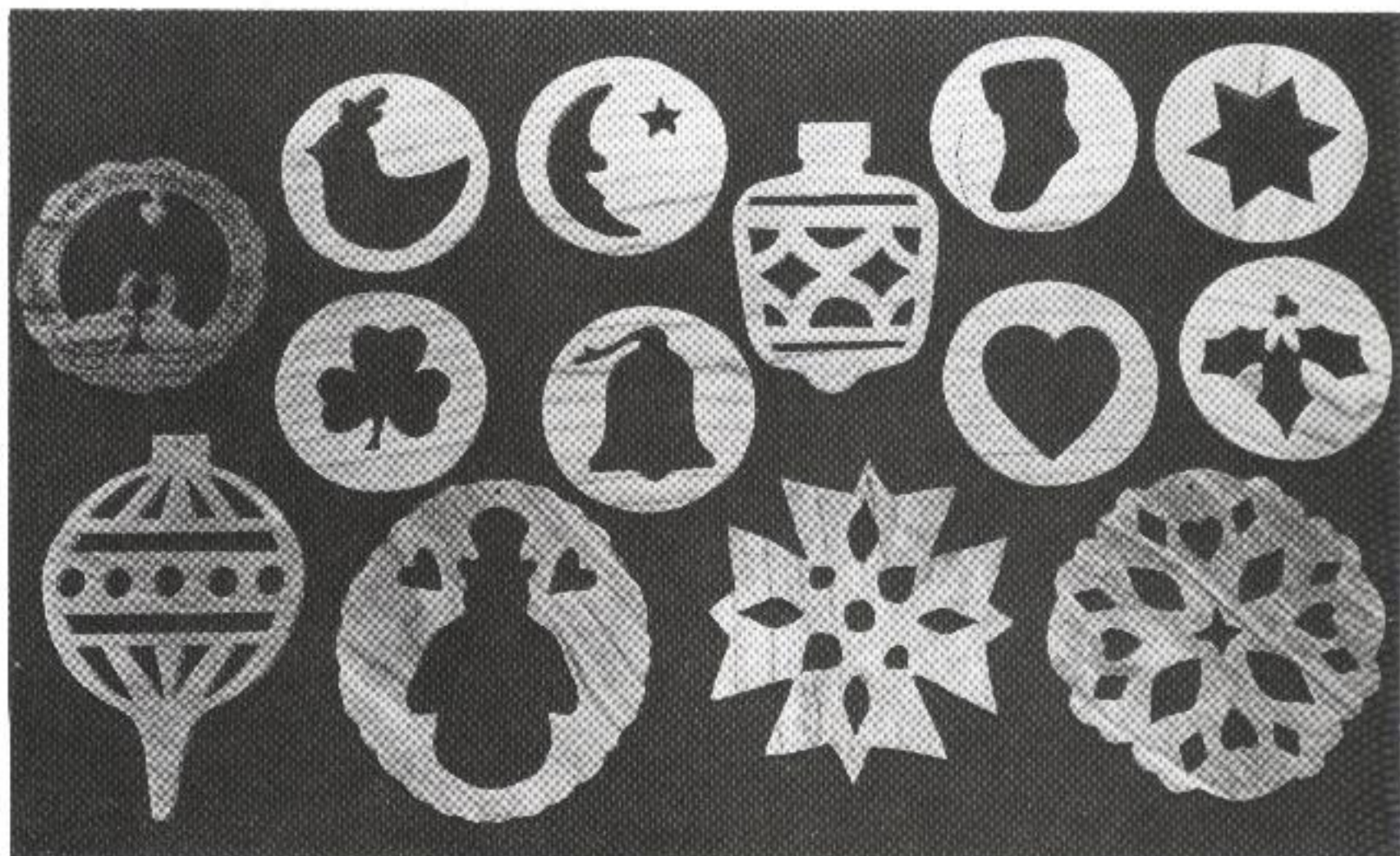

*Ornaments made from 1/4-inch material.*

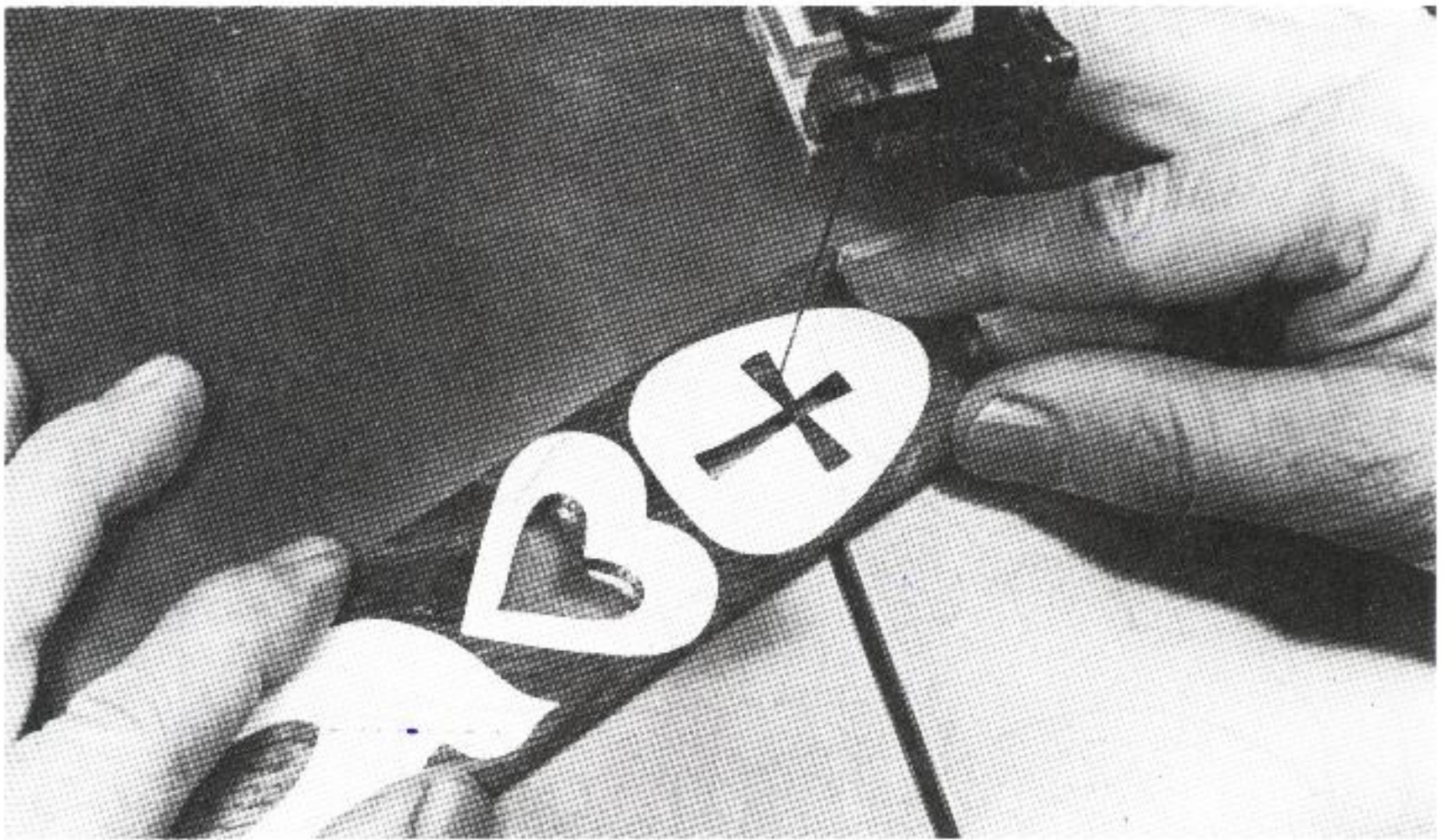

*Sawing out jewelry. Paper patterns are glued to the work with rubber cement.*

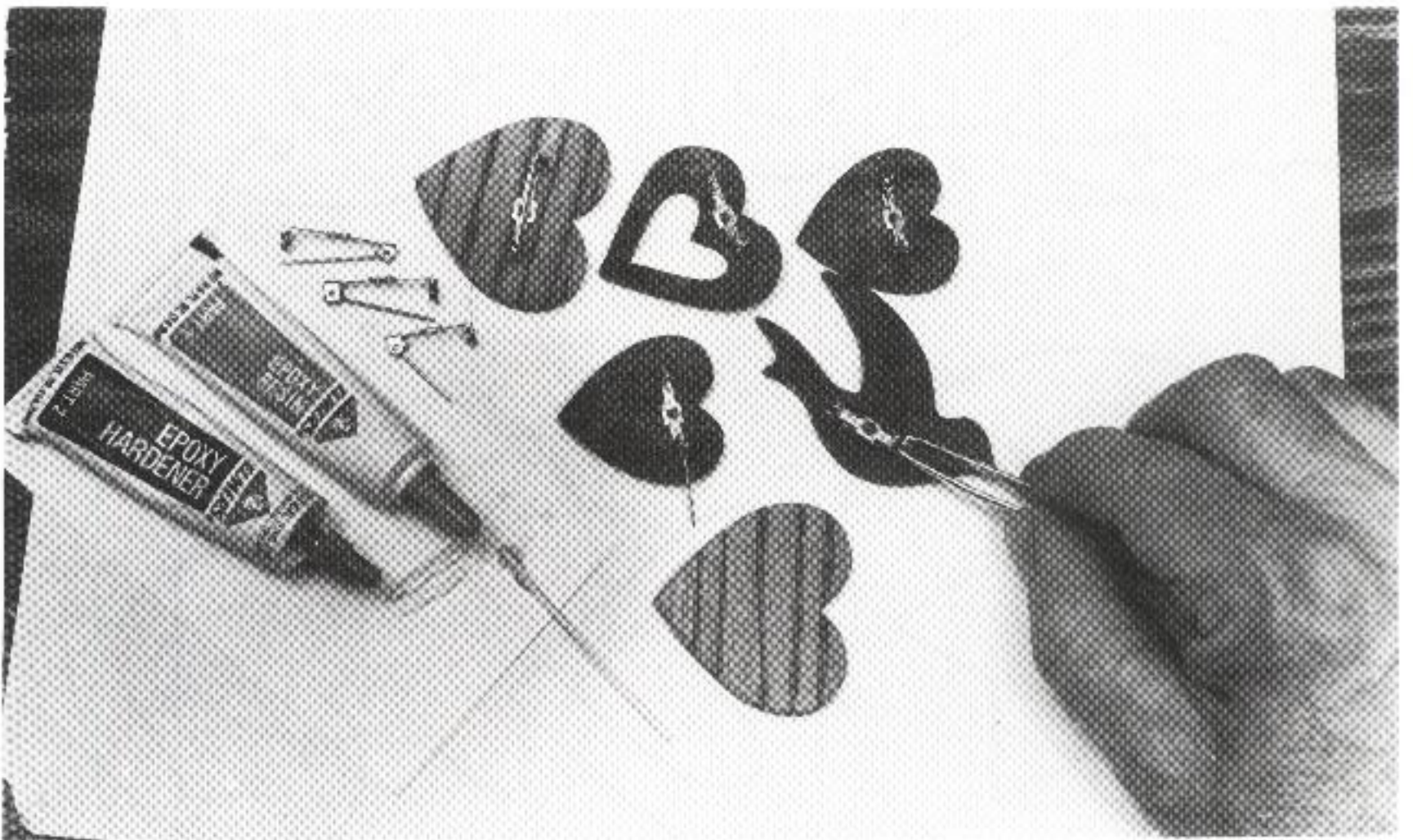

*Use epoxy to bond findings to the cutouts.*

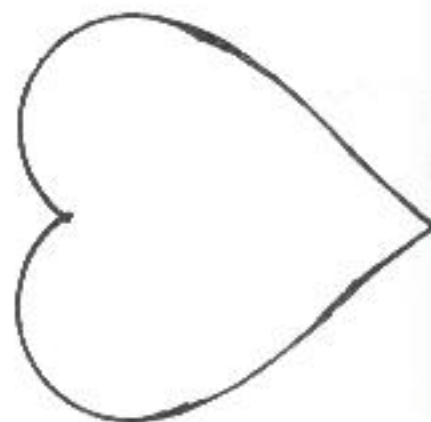
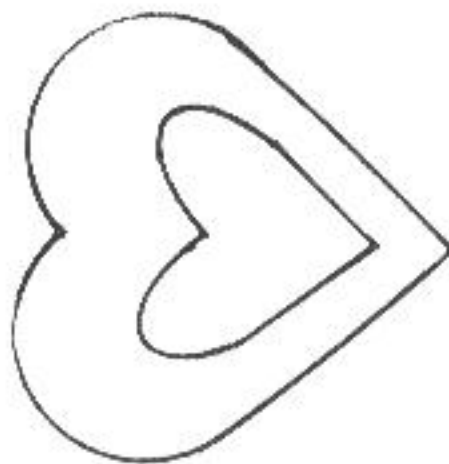
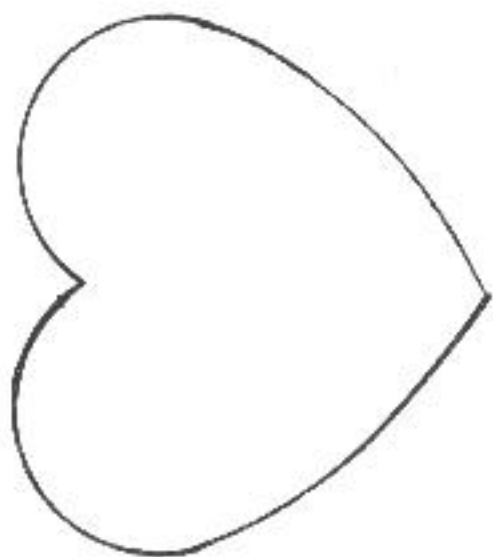
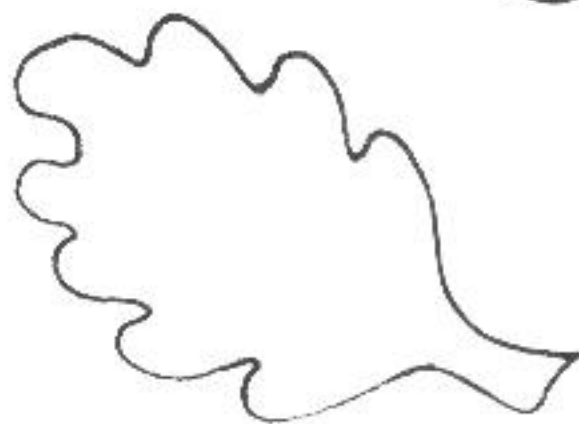
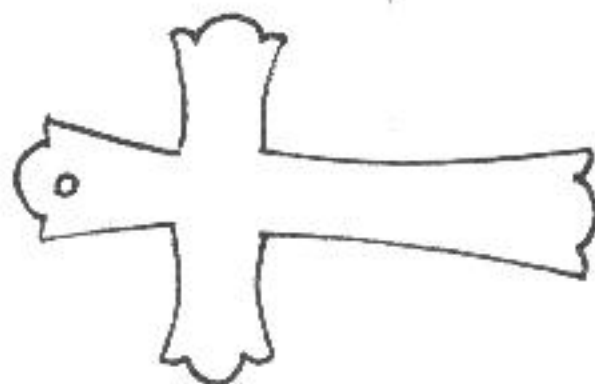
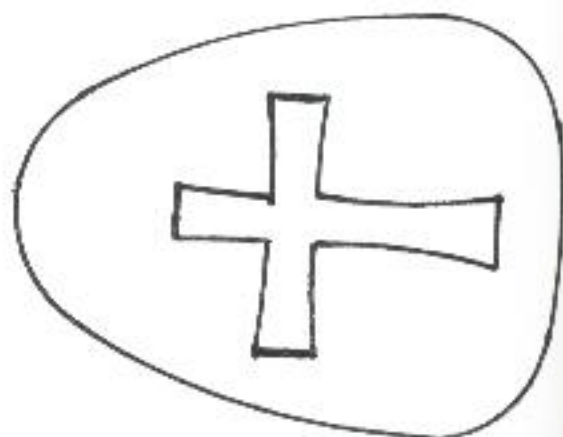
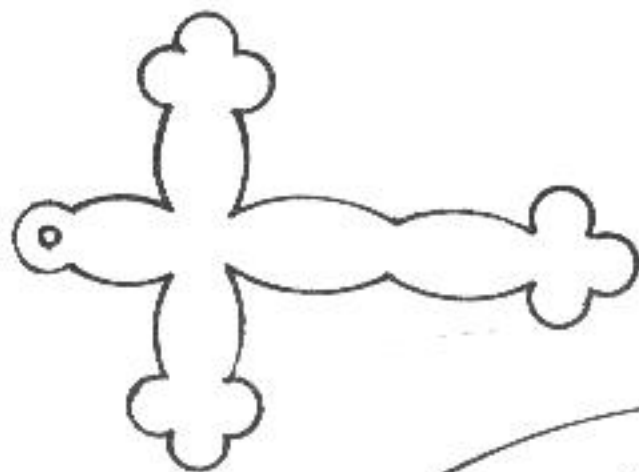
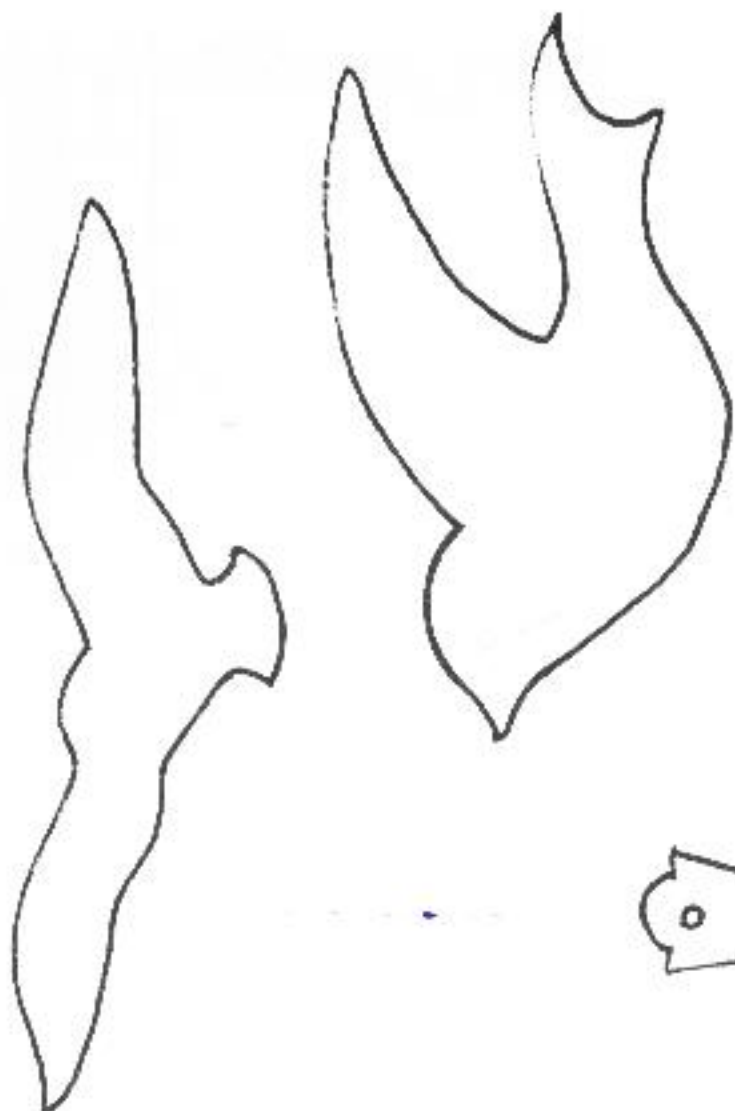

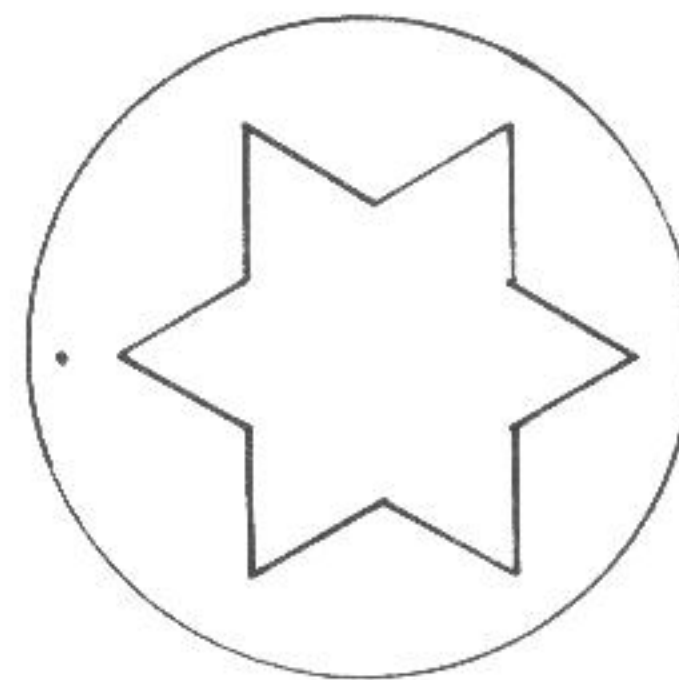
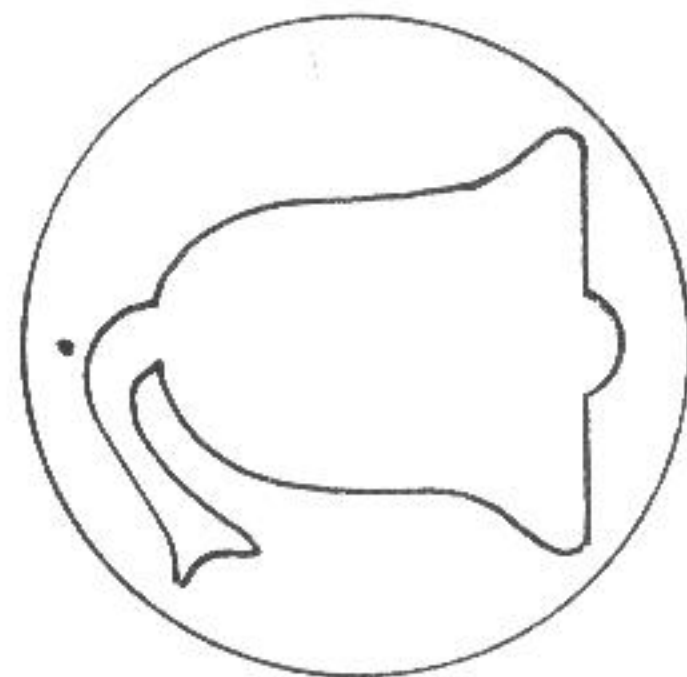
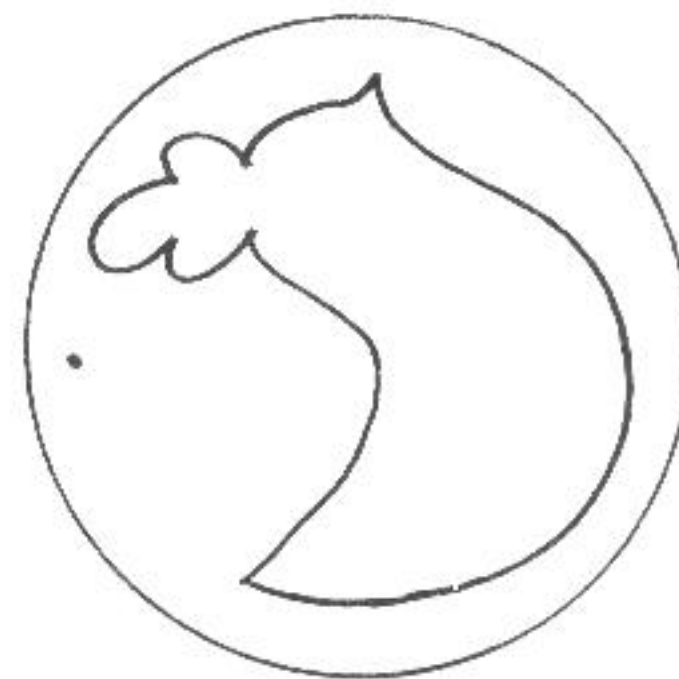
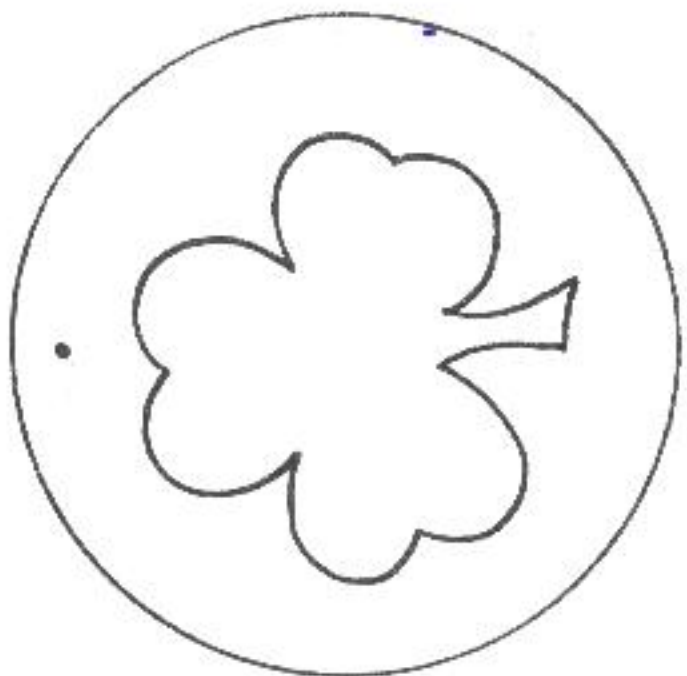
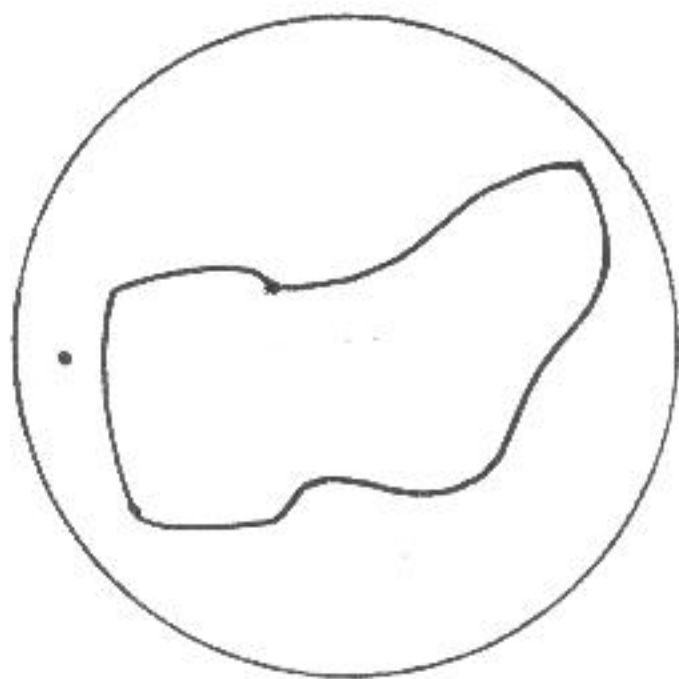
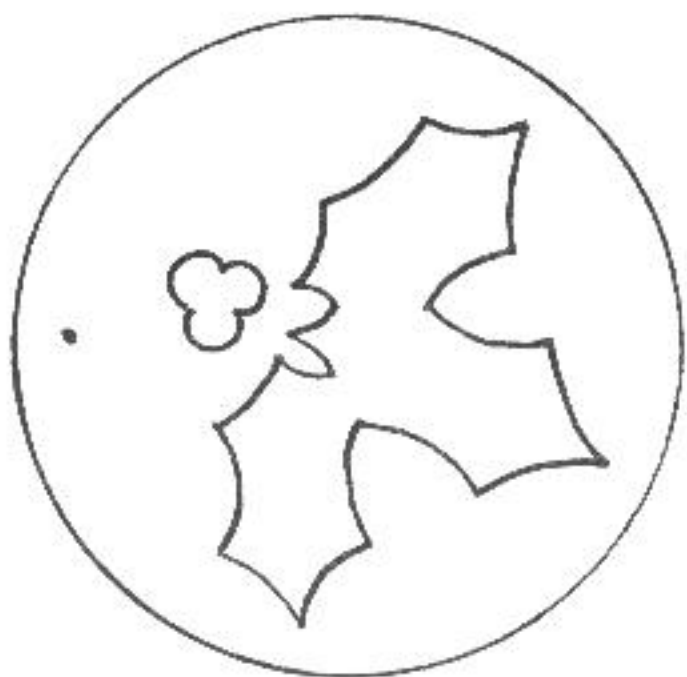

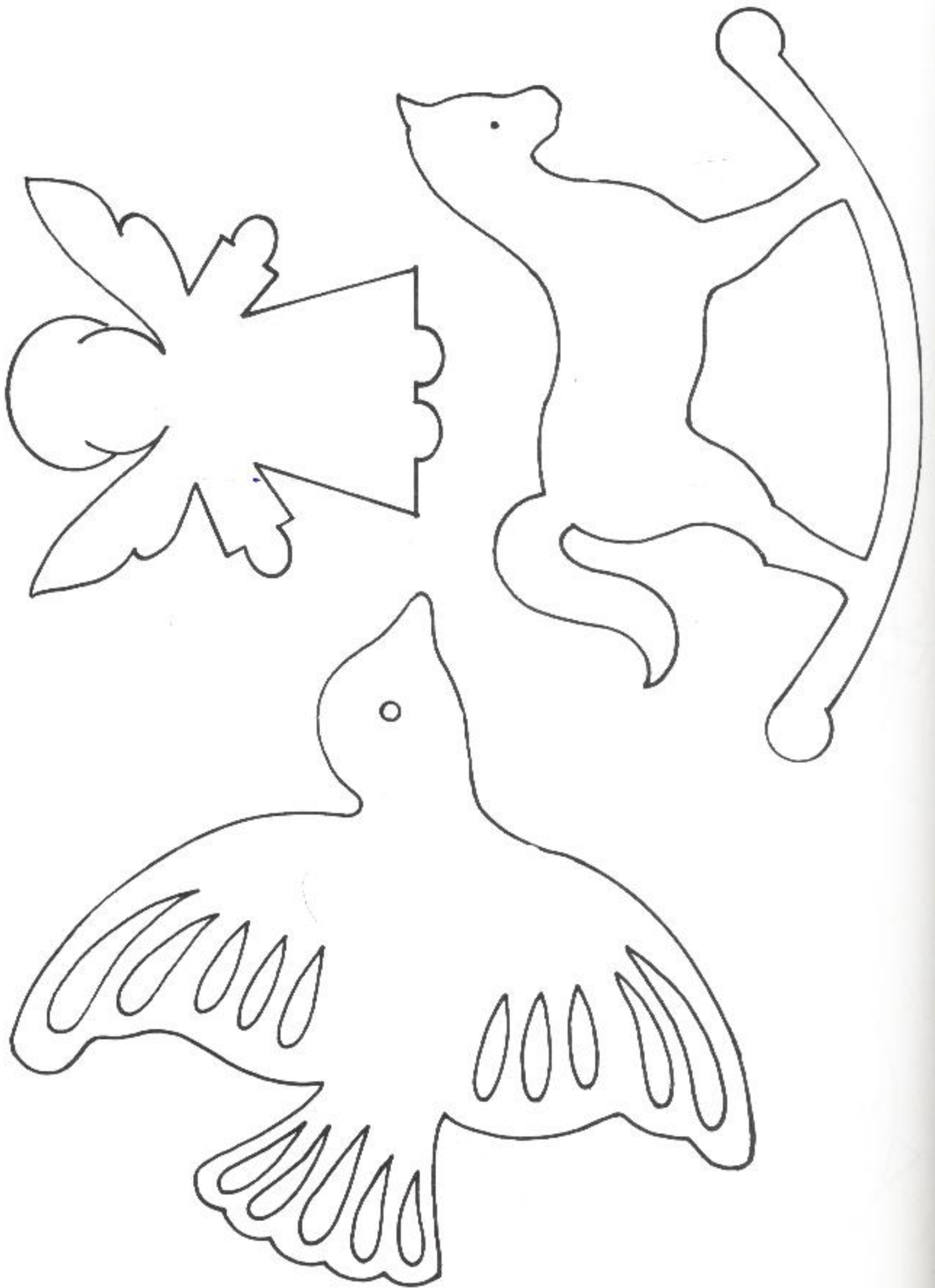



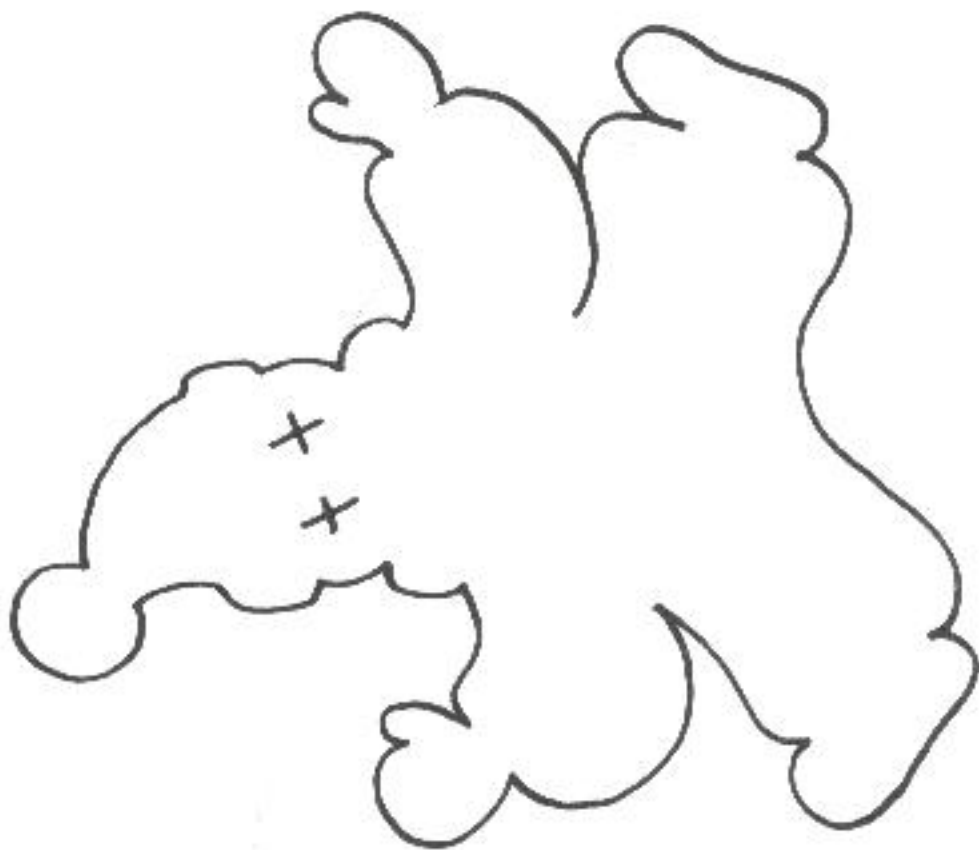
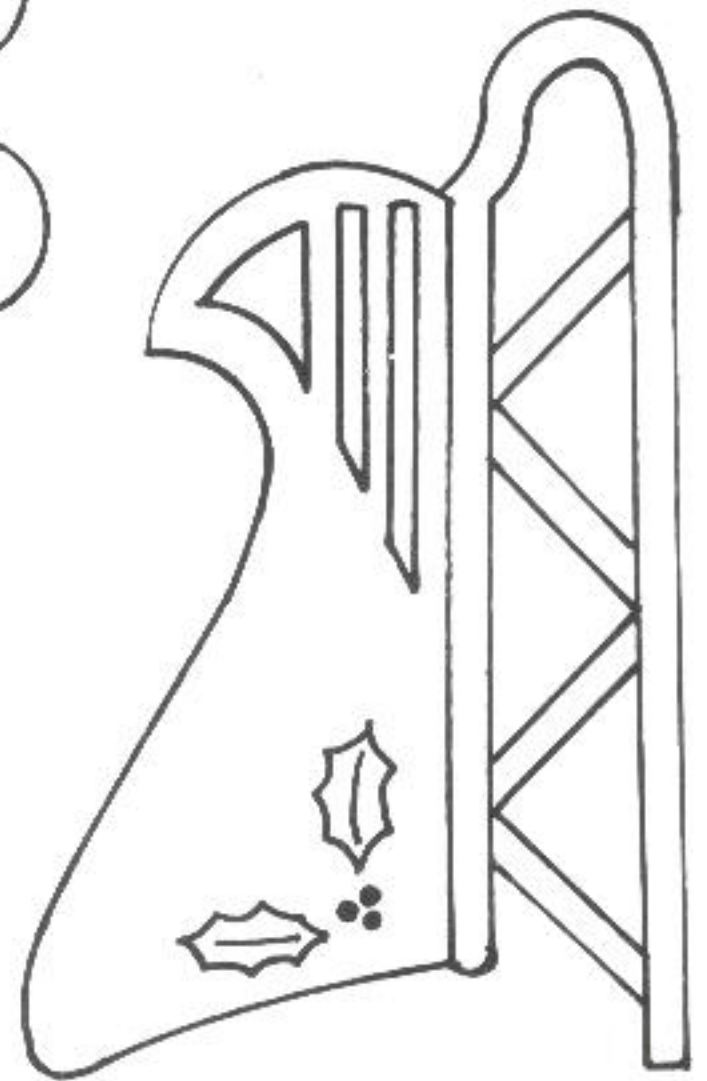
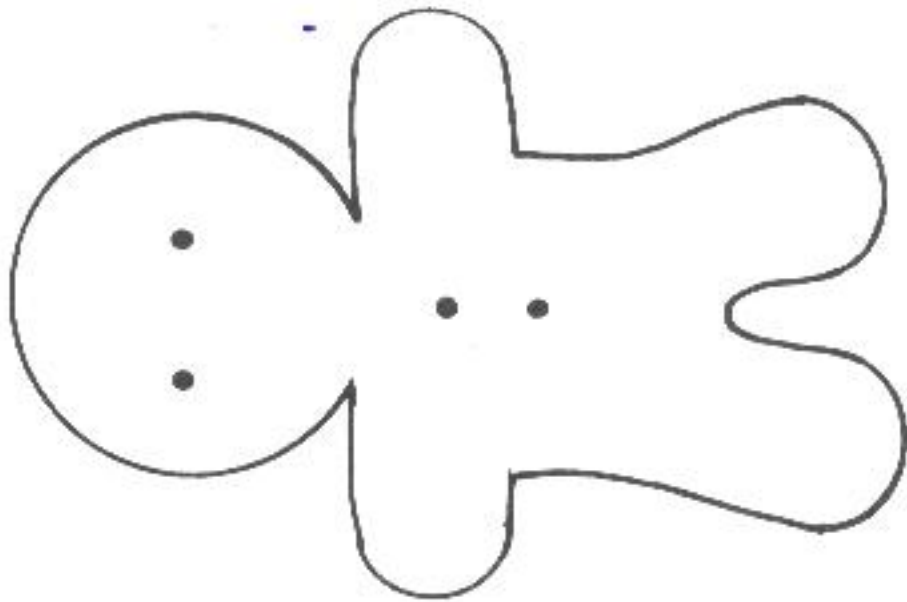
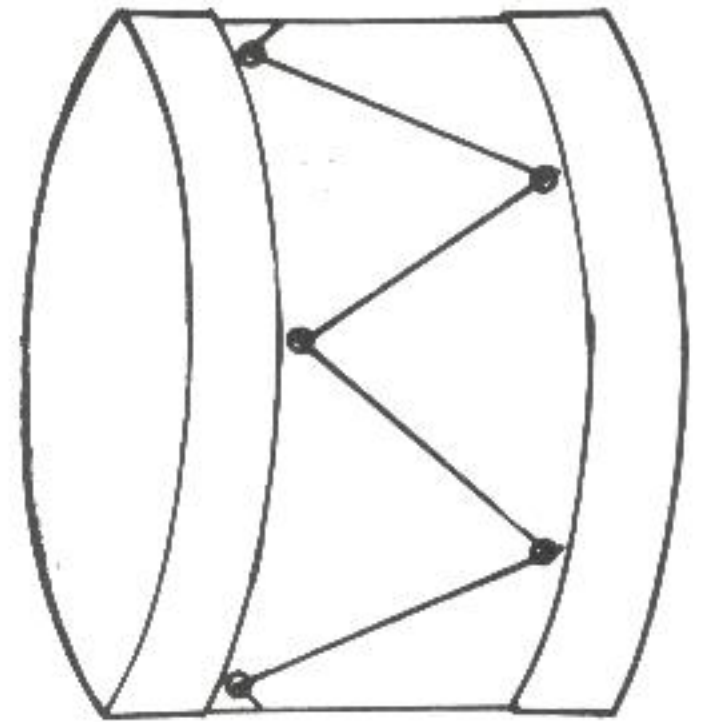
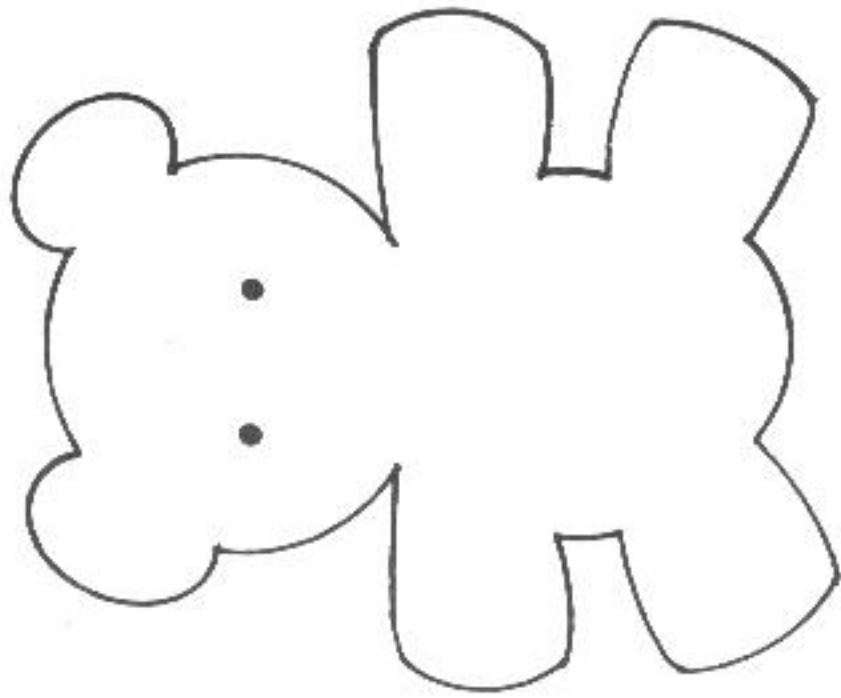

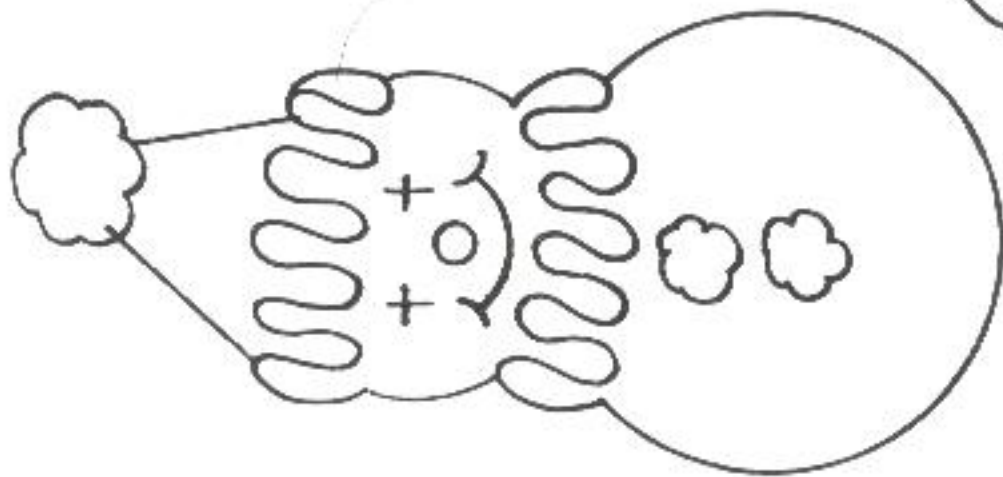
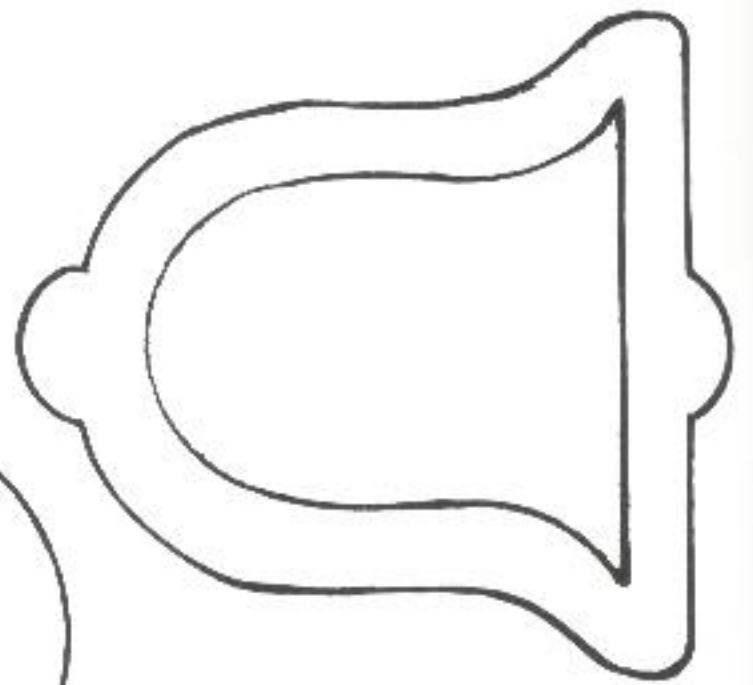
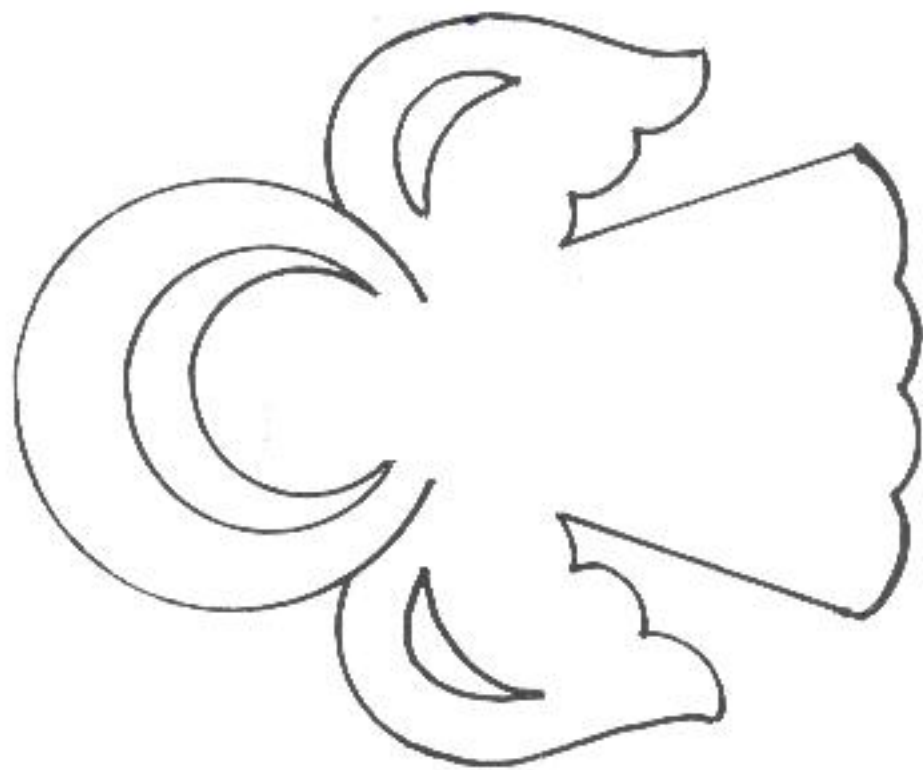
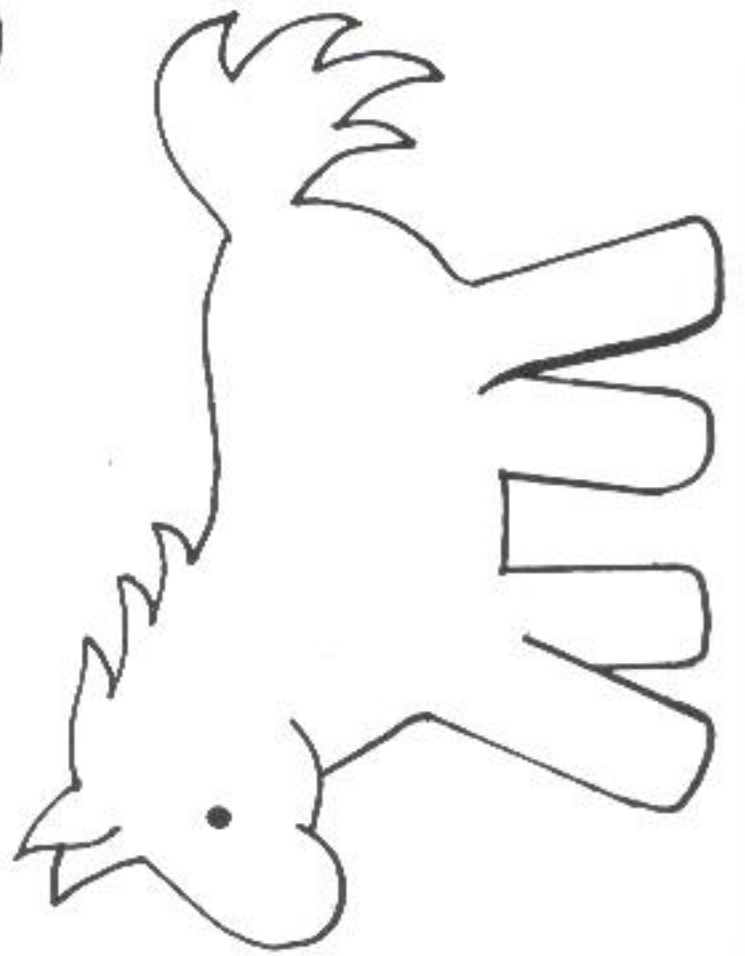
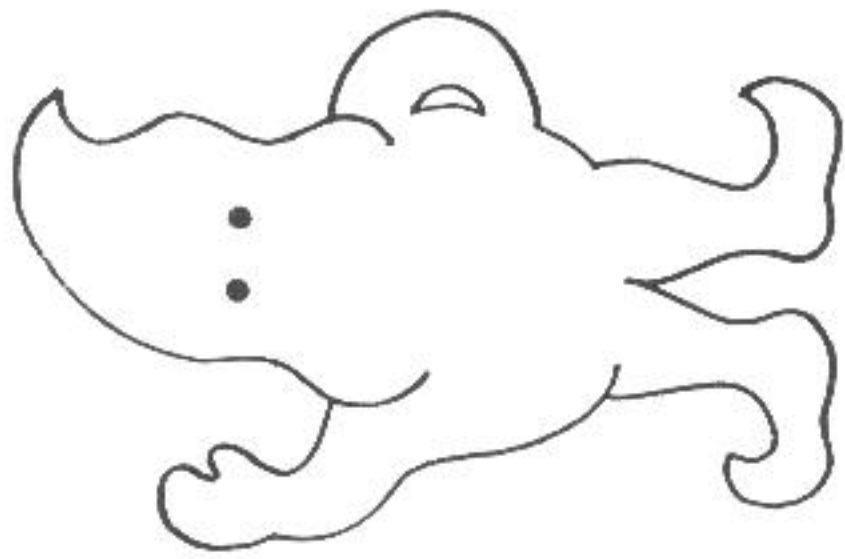

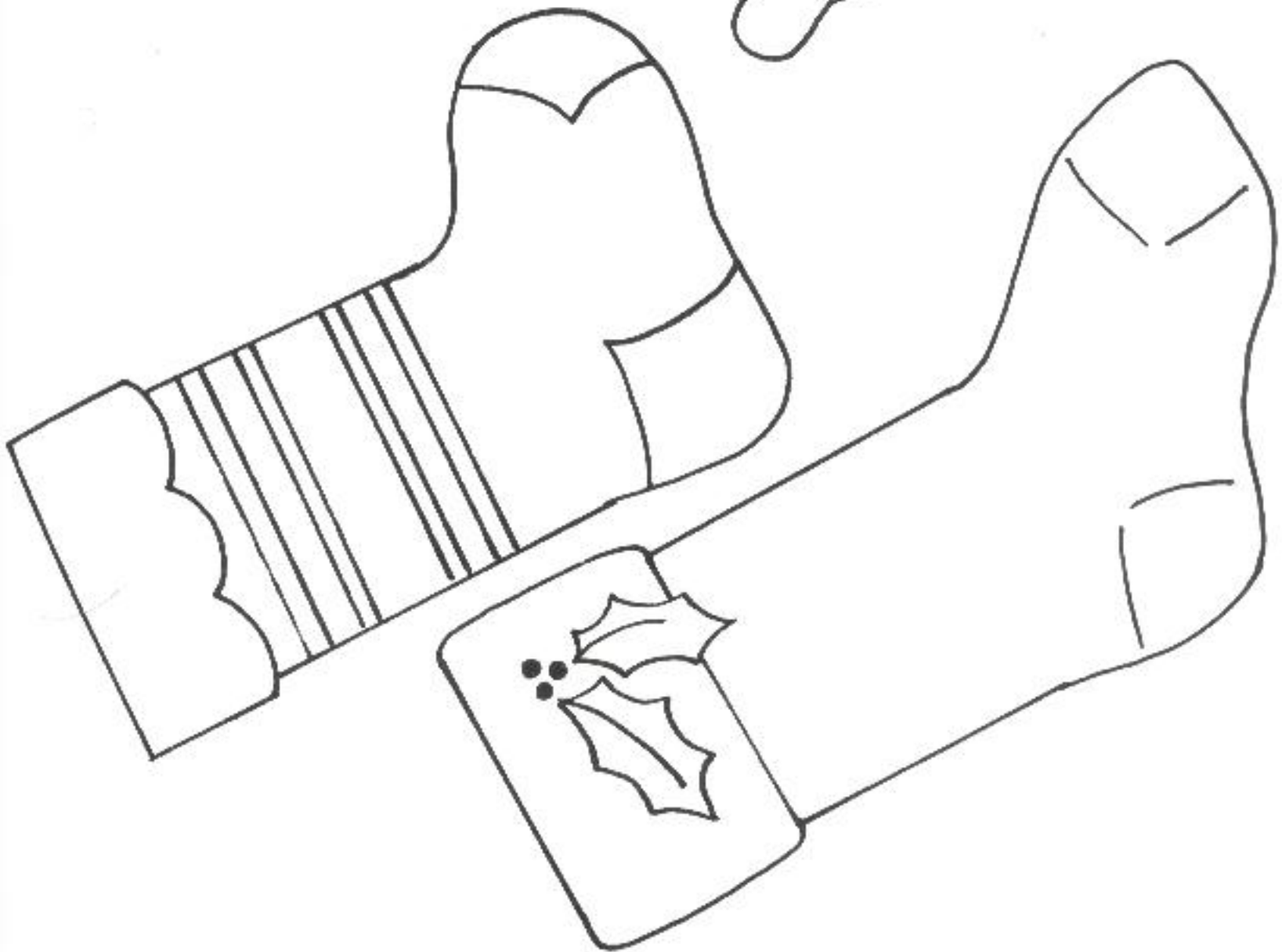
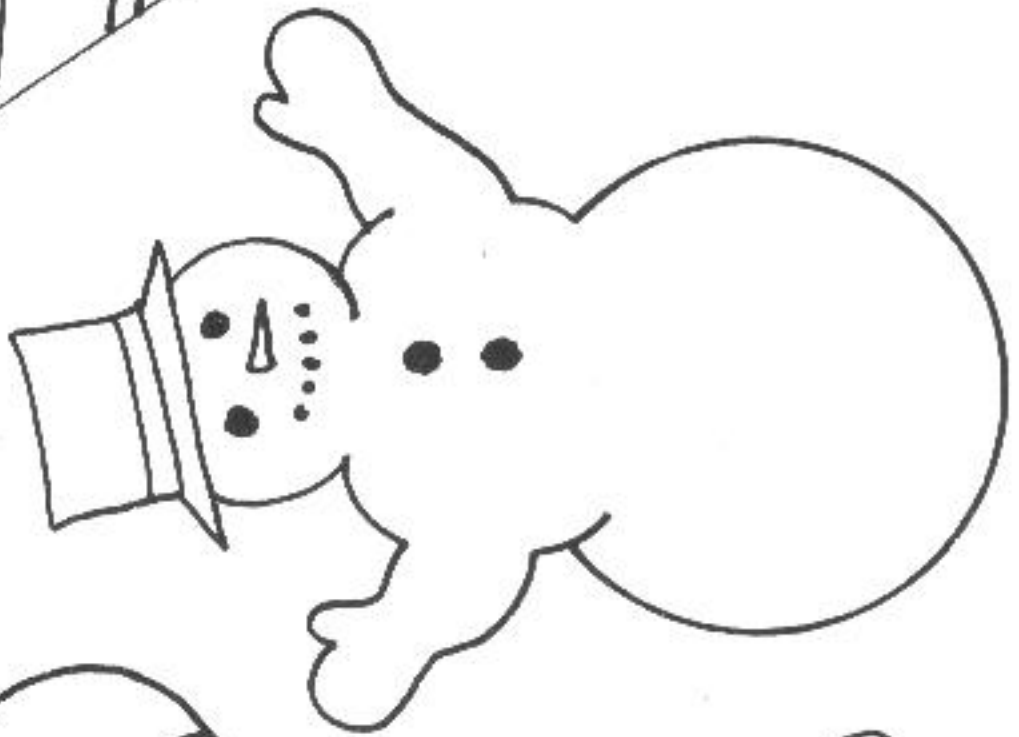
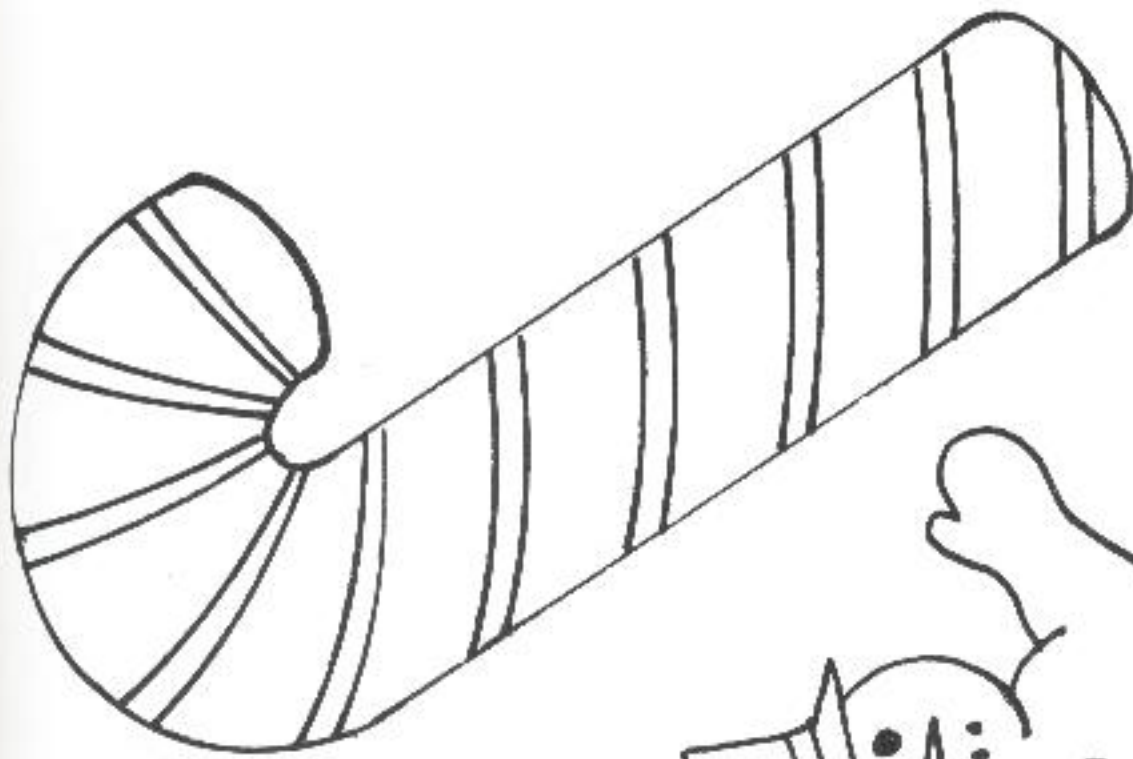

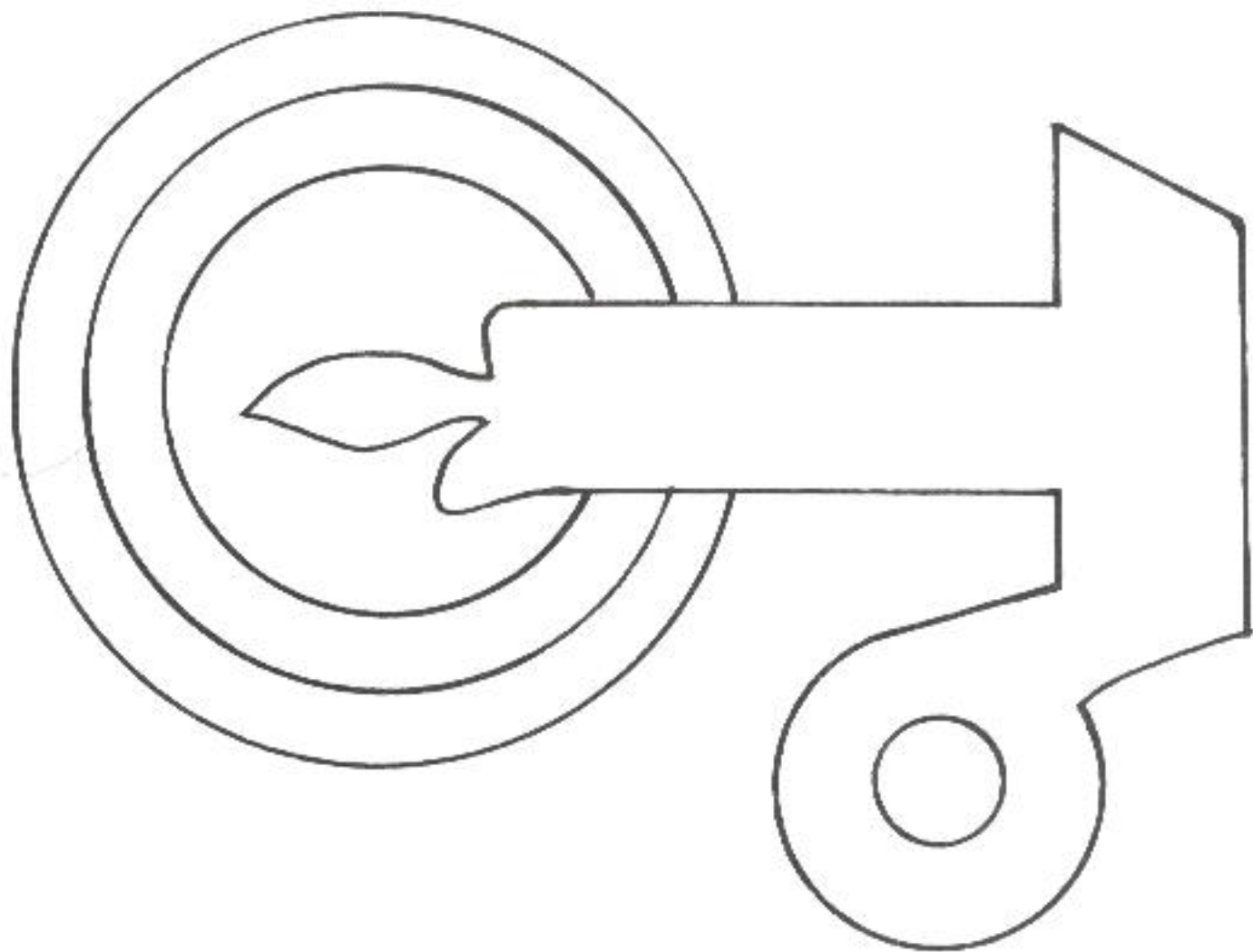
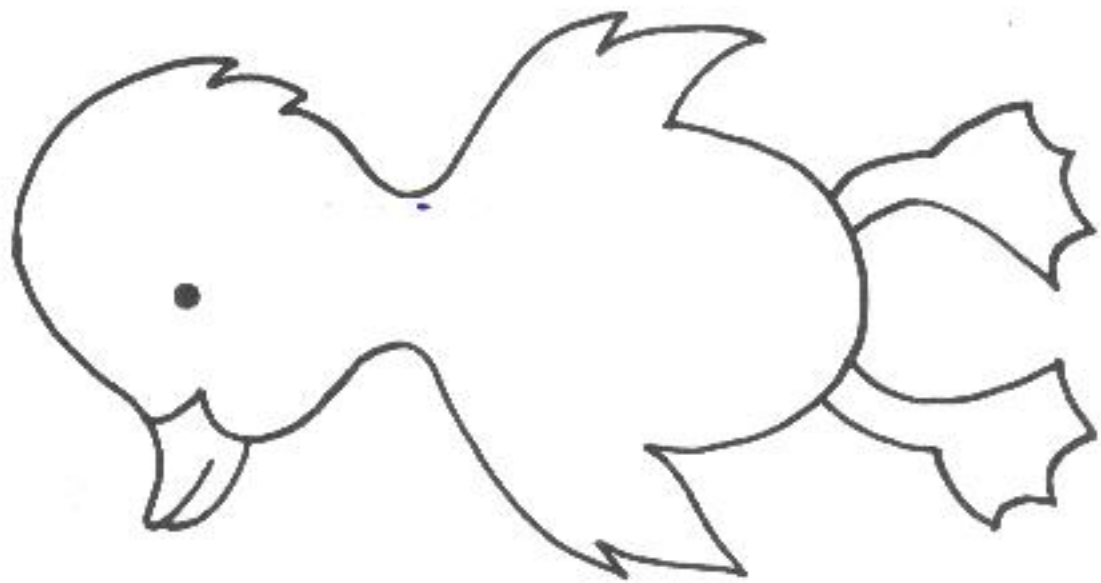
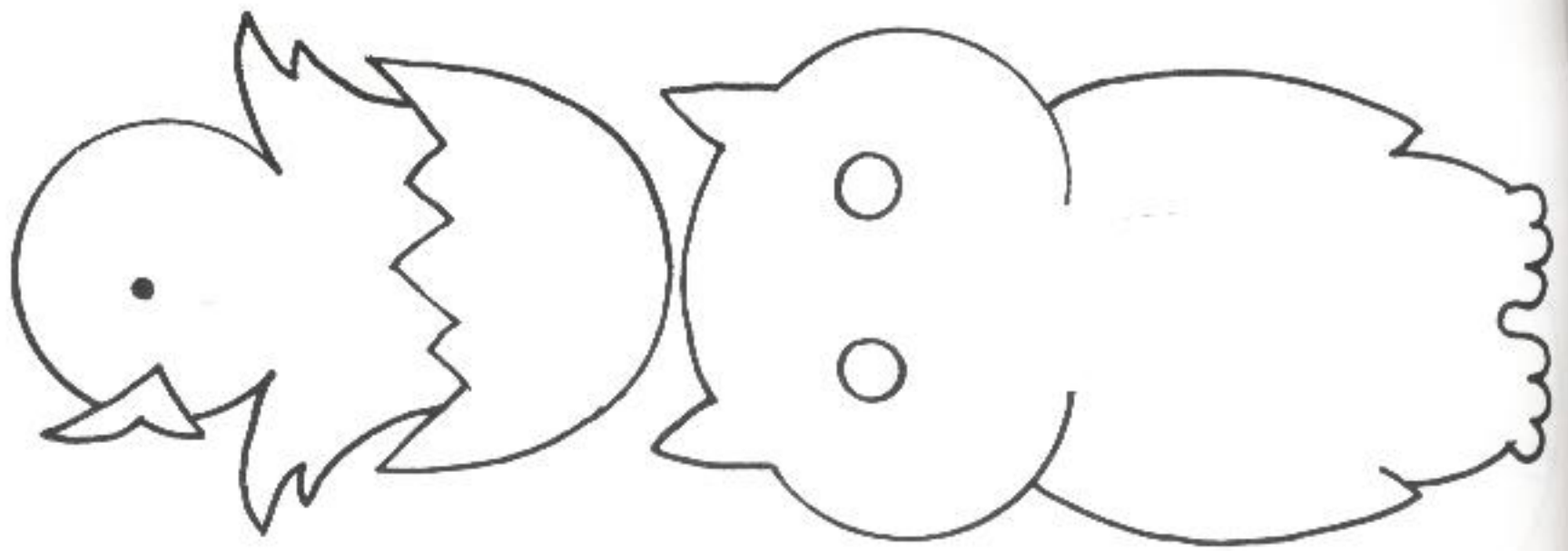

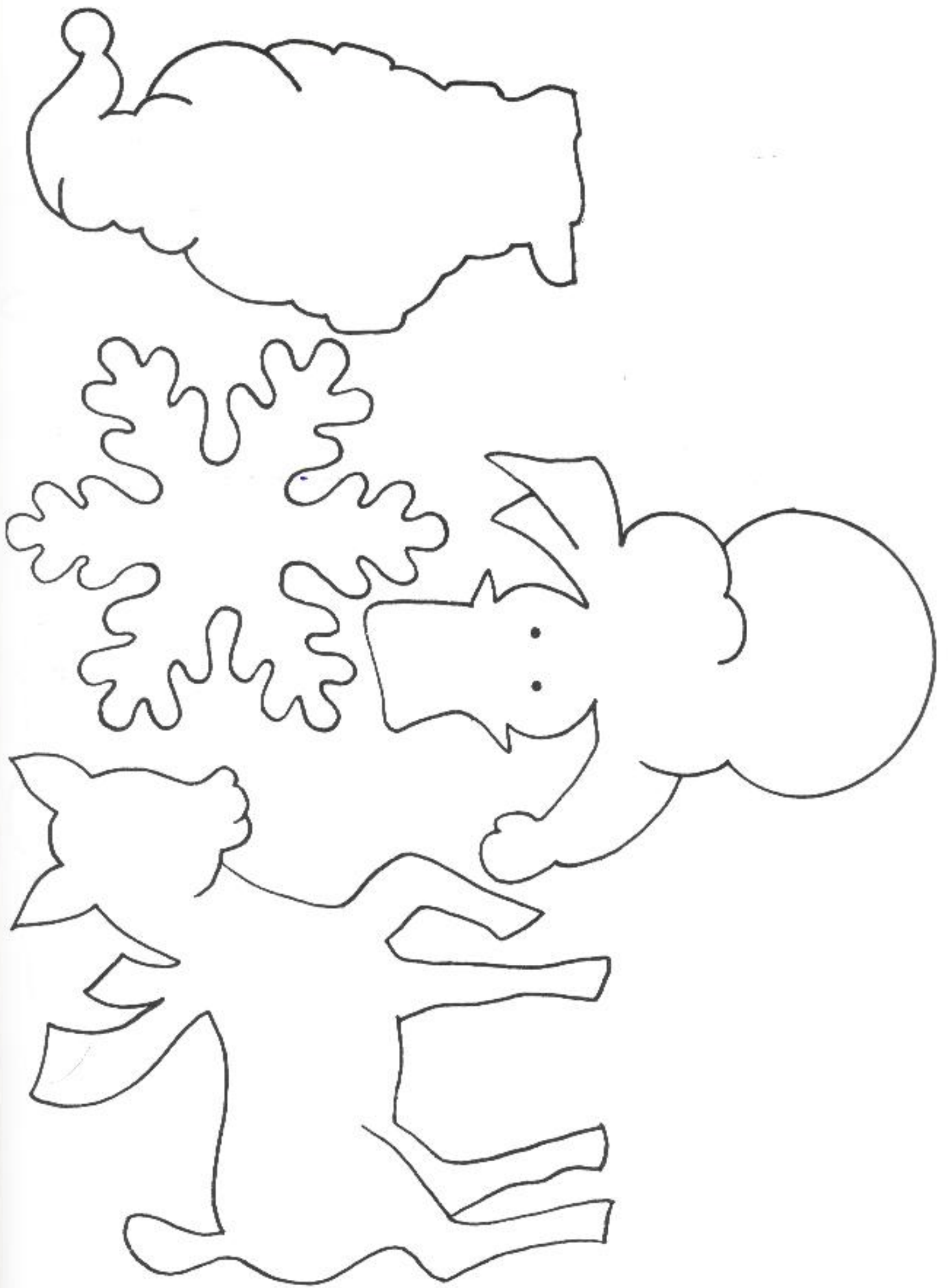

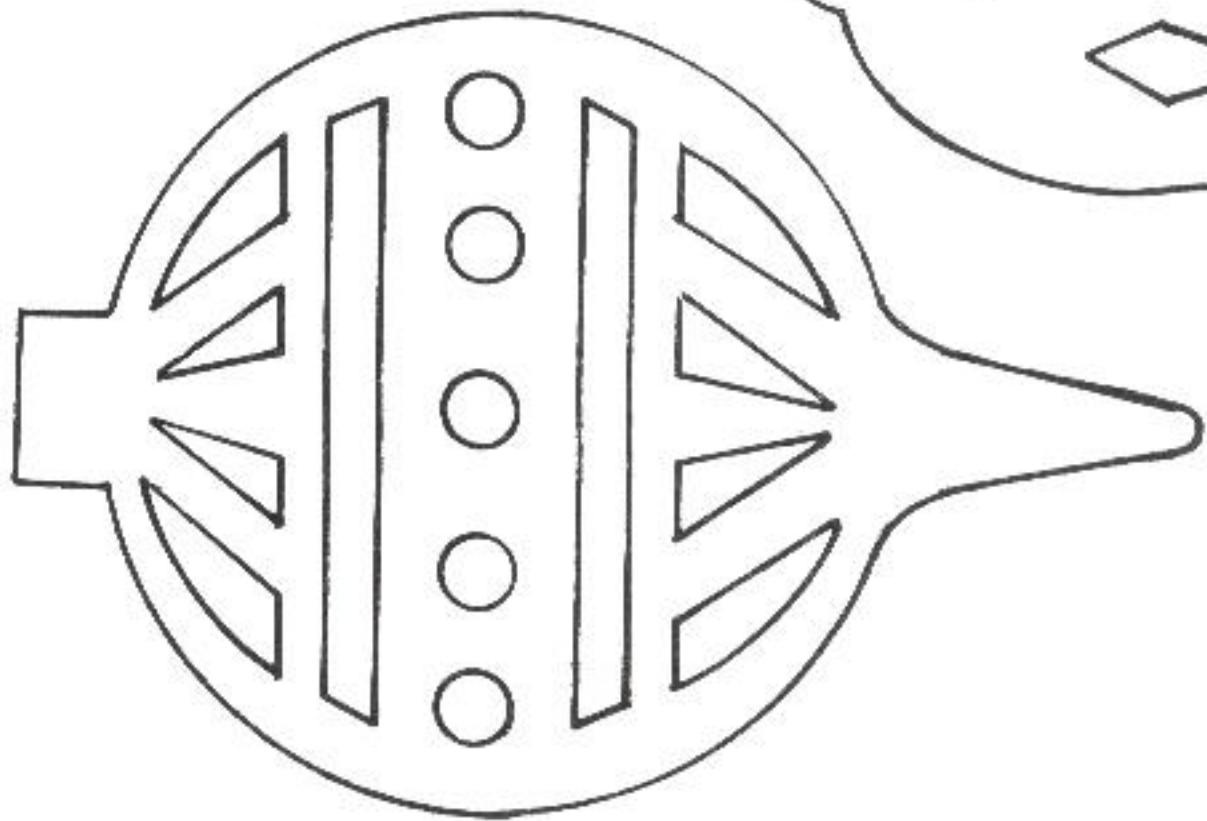
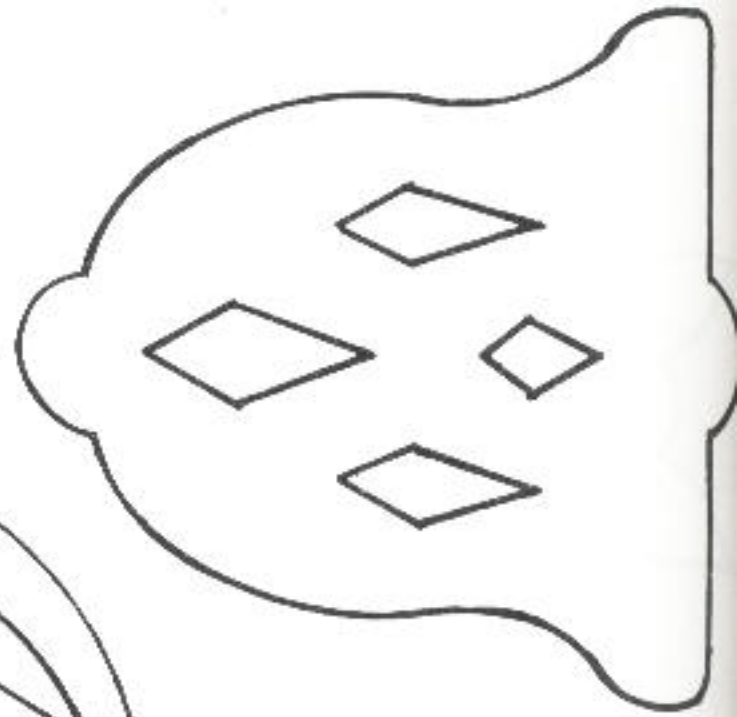
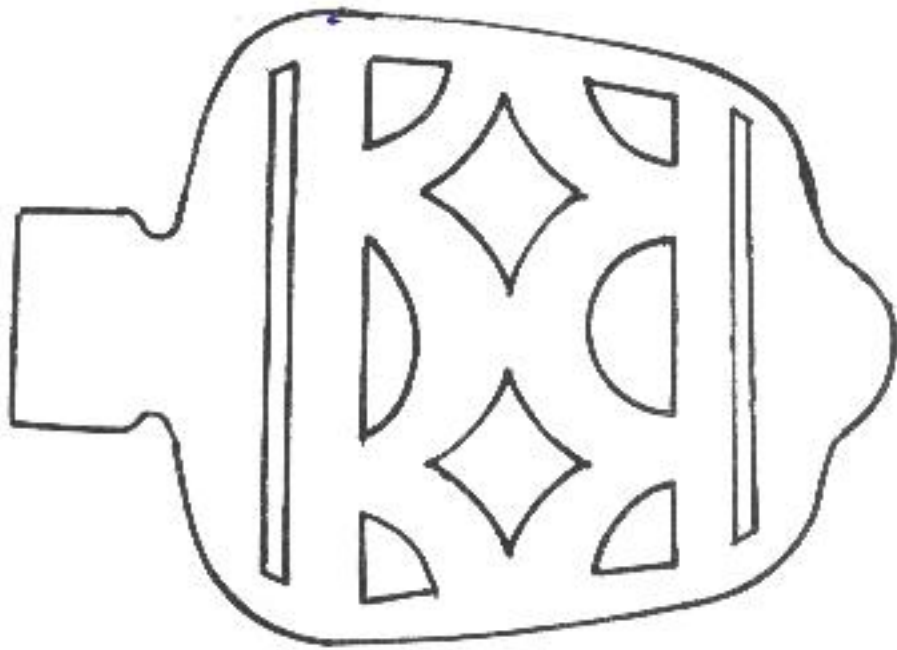

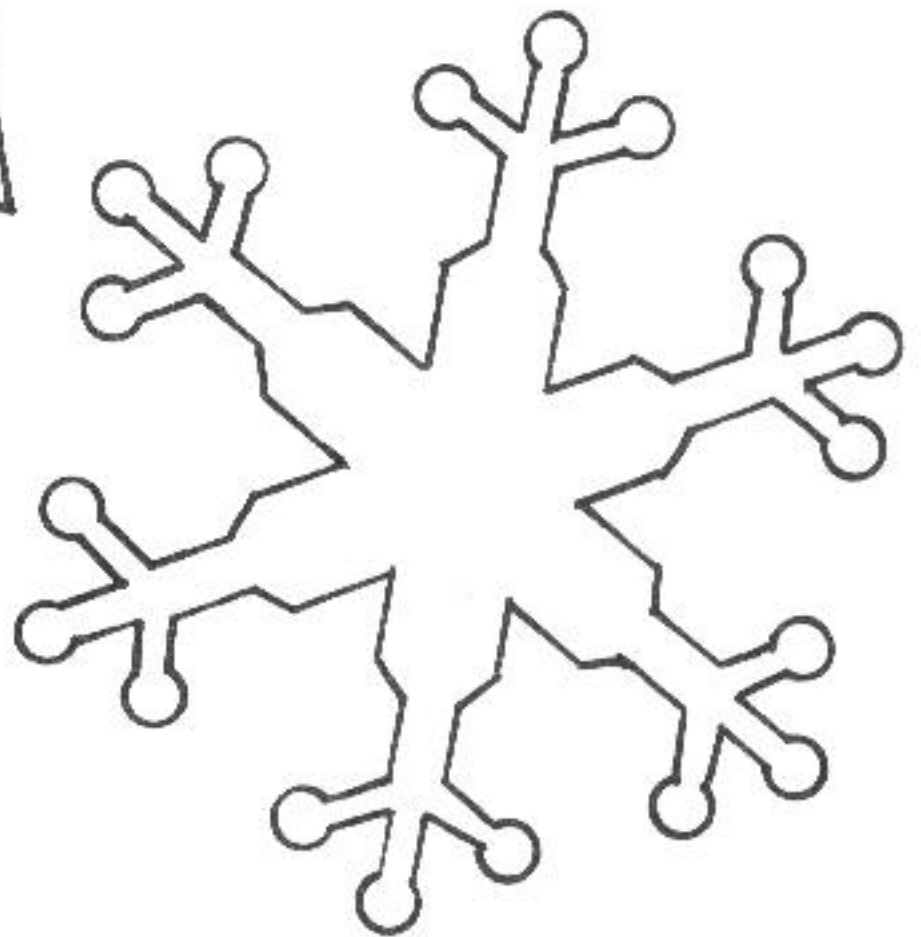
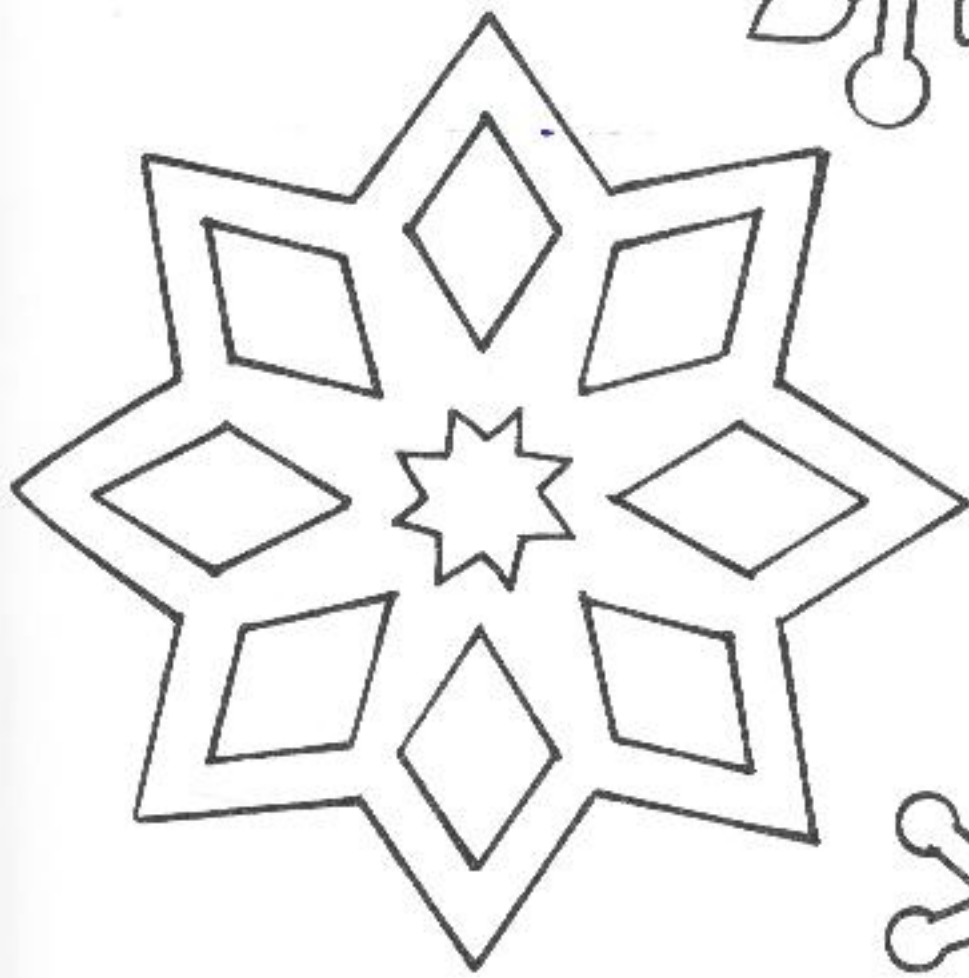

# Candle Holders/Pegboards/Brackets

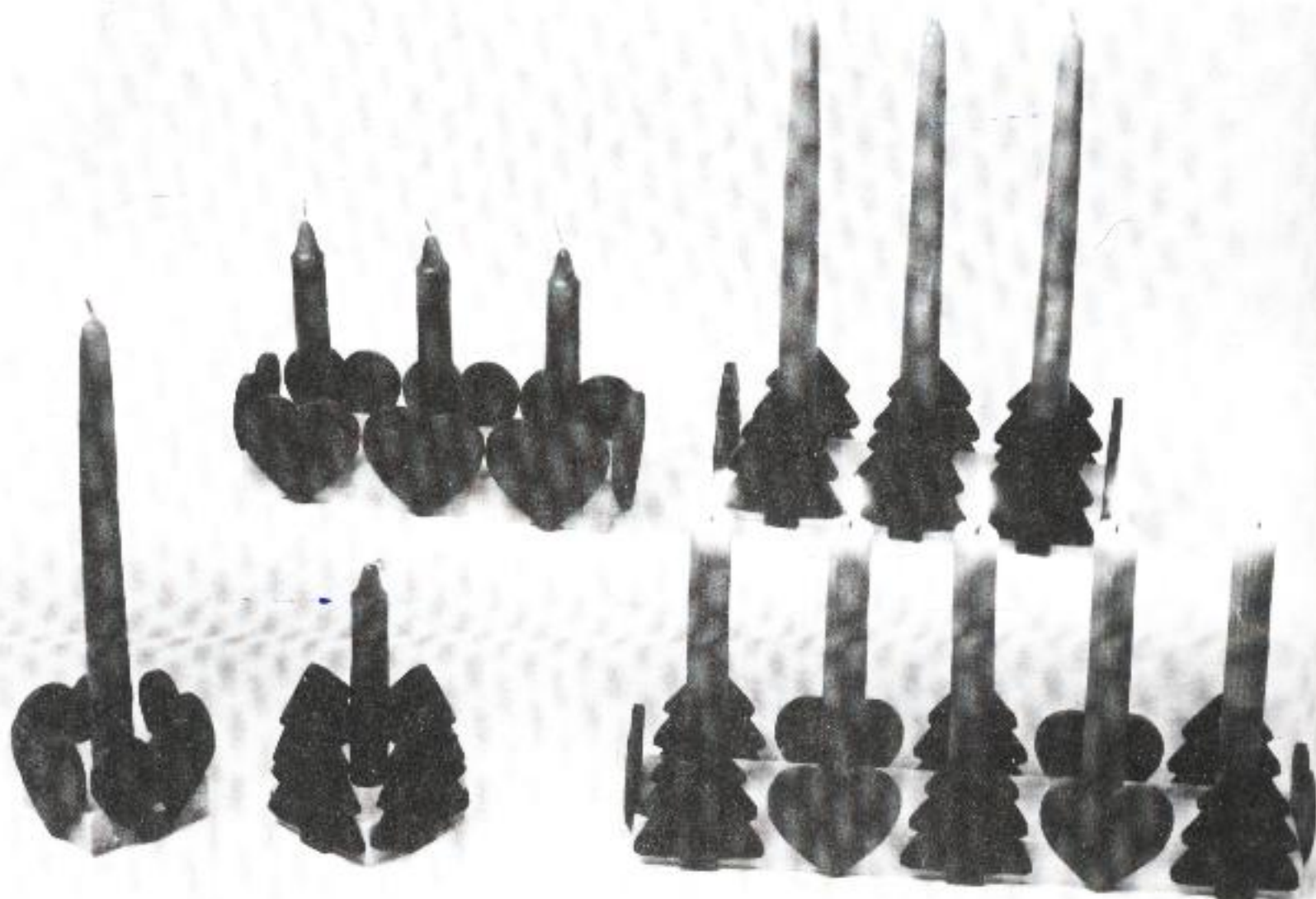

*Candle holders. Use 1/4-inch material for cutouts. Patterns can be found on pages 152 and 153.*

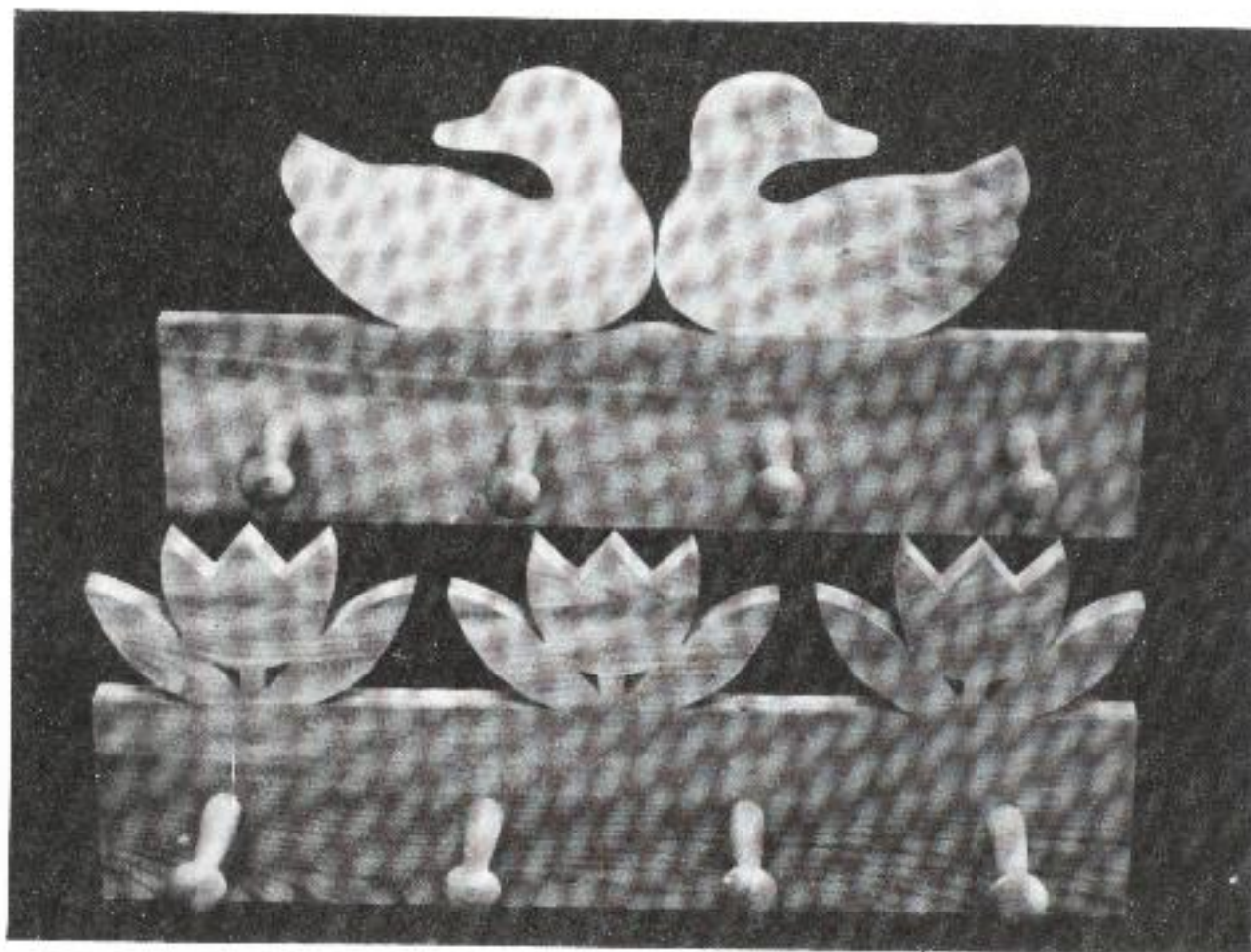

*Pegboards.*



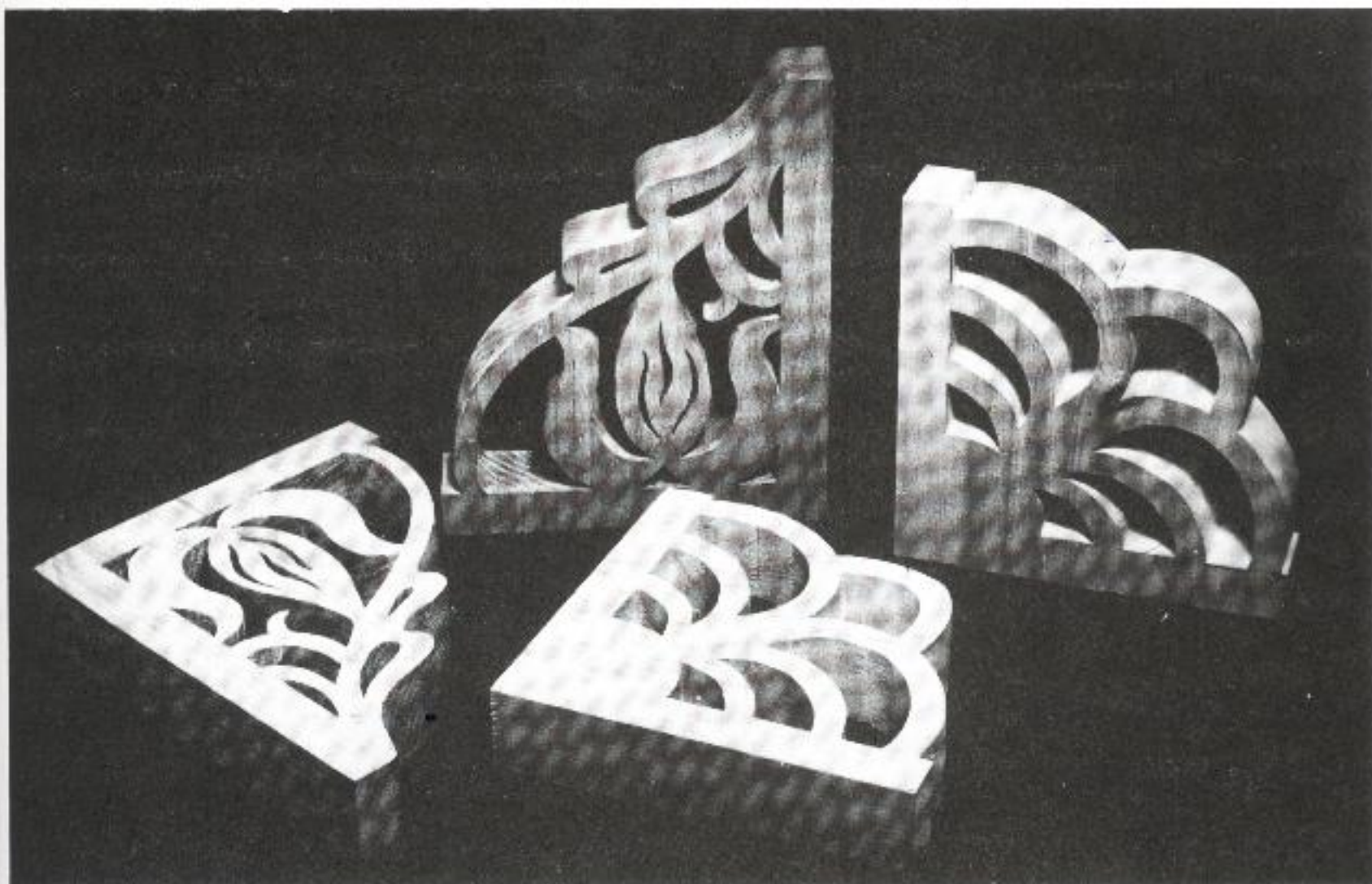

Brackets.

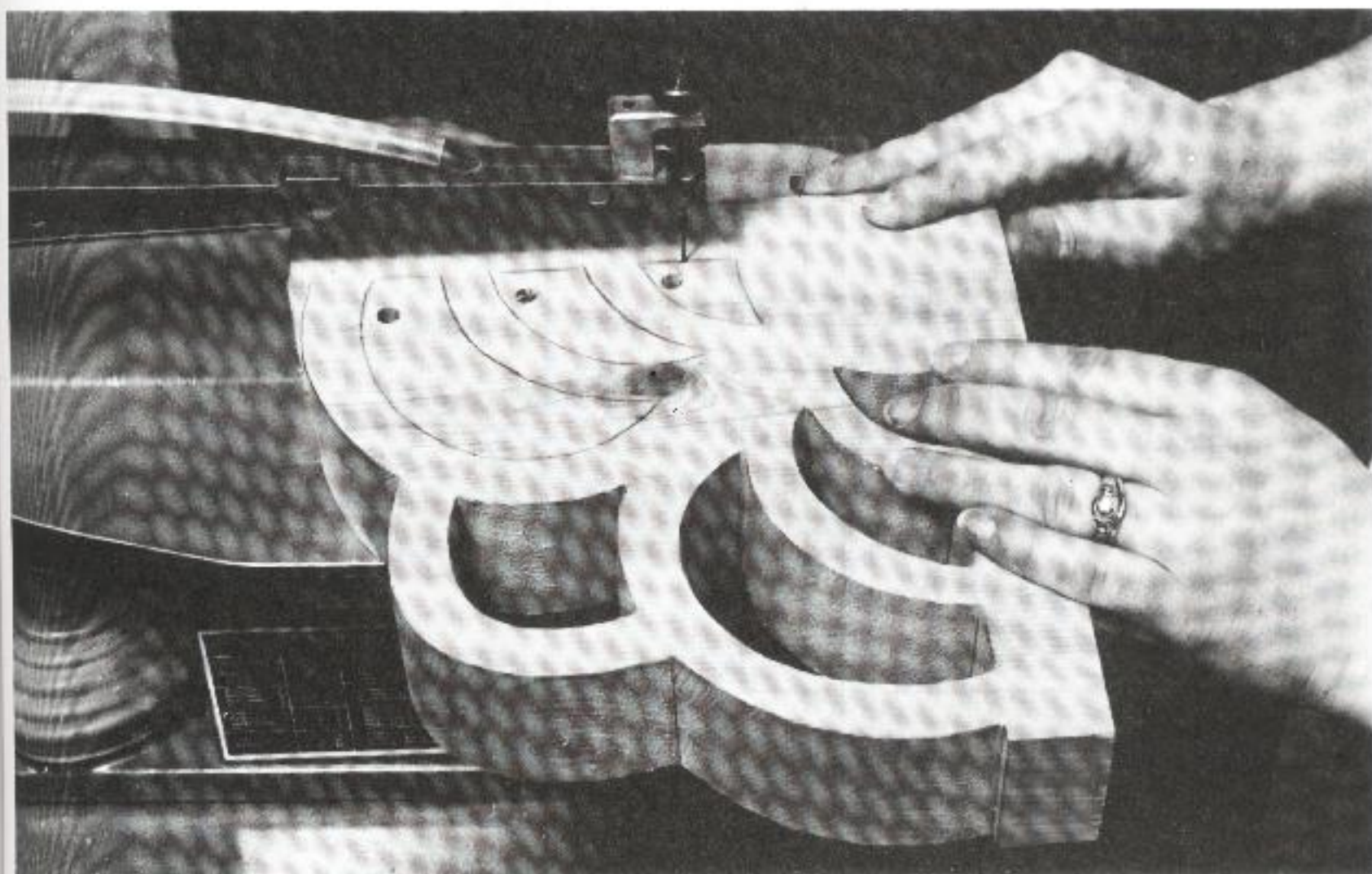

Sawing a corner bracket from 1 $\frac{3}{4}$ -inch-thick stock.

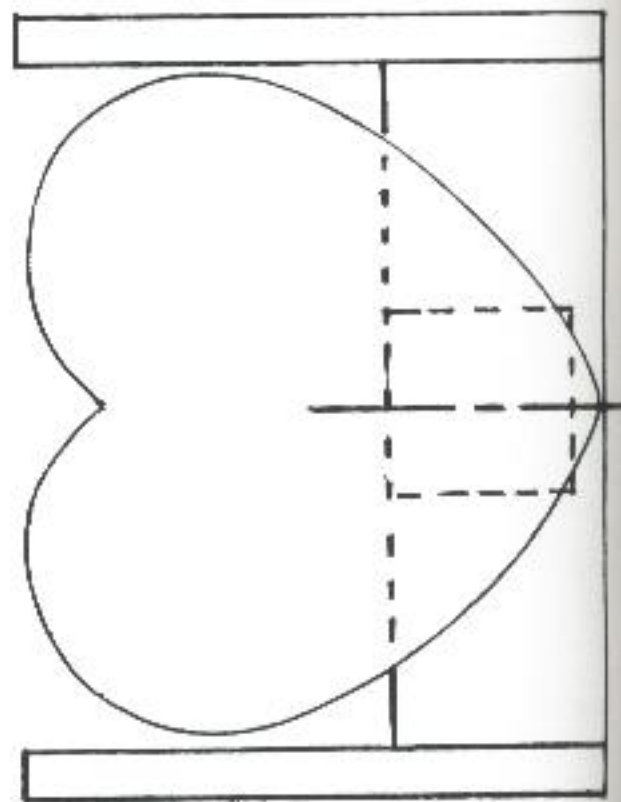
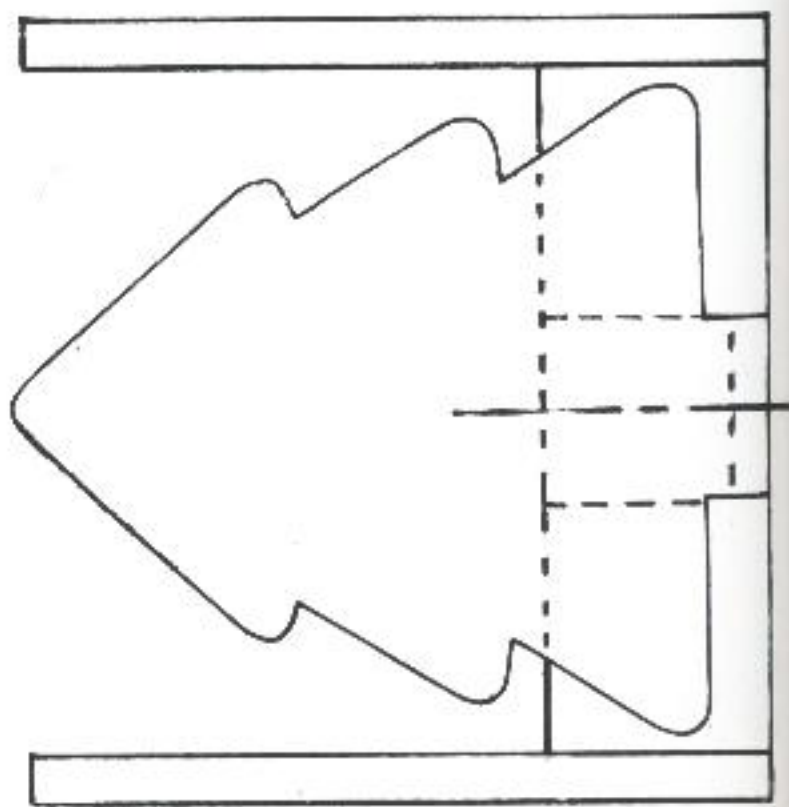
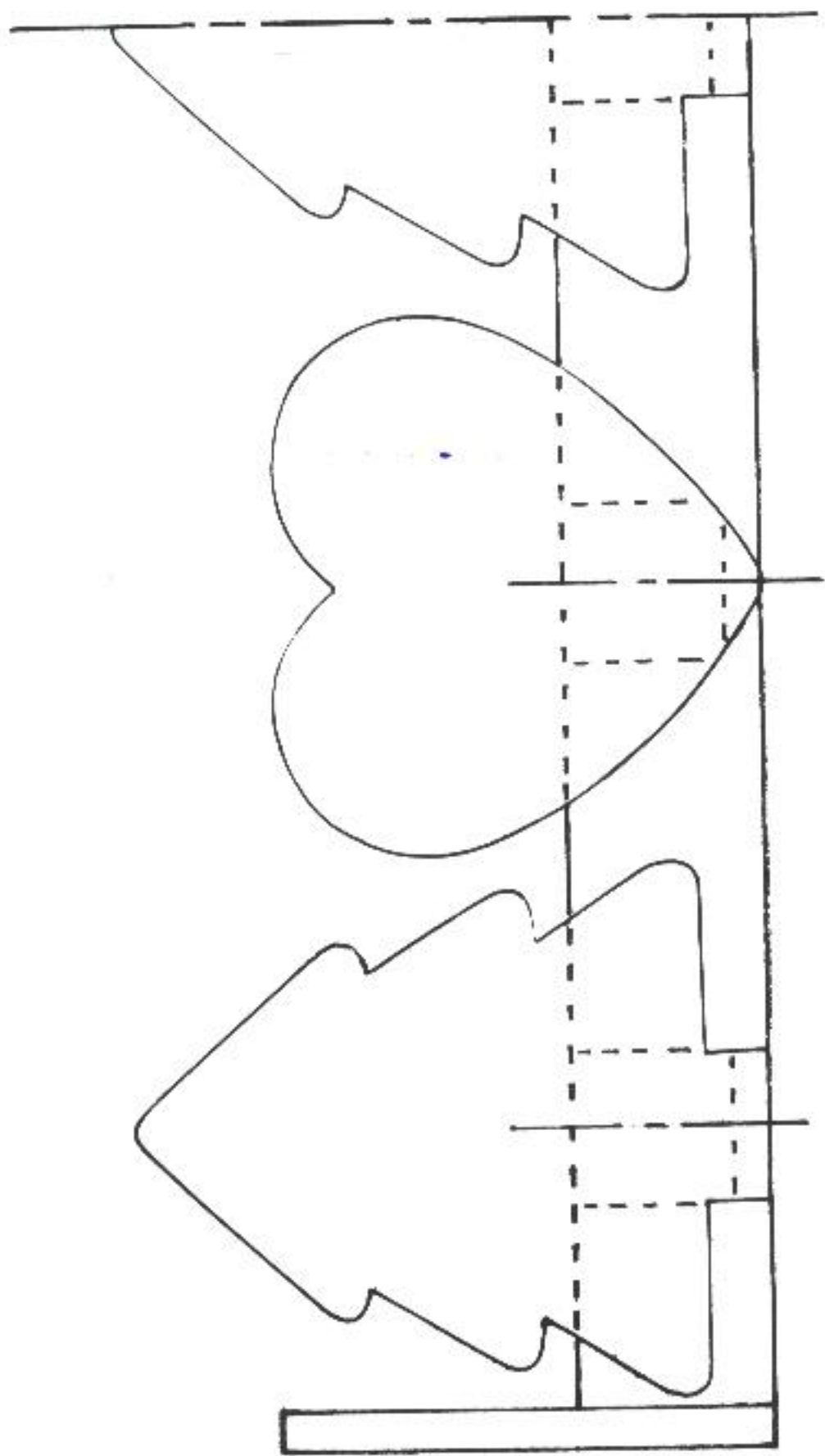

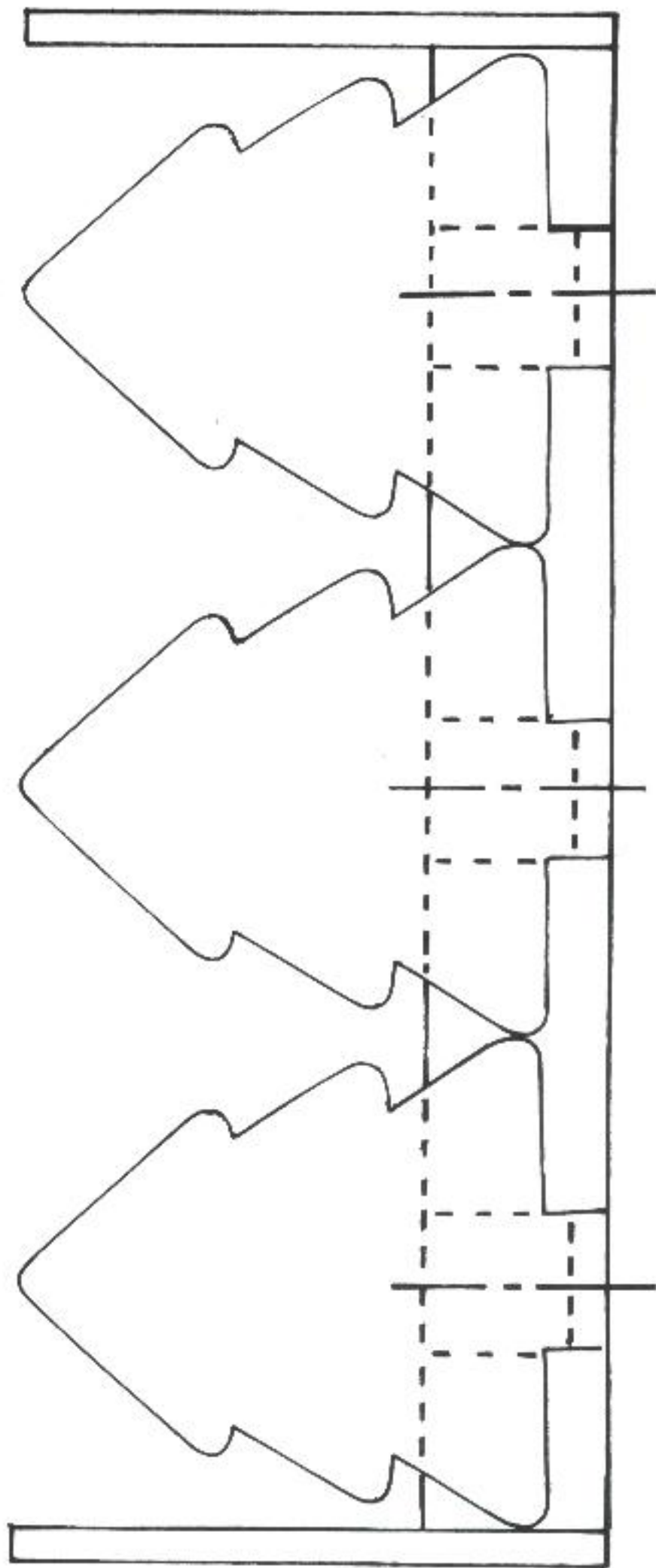
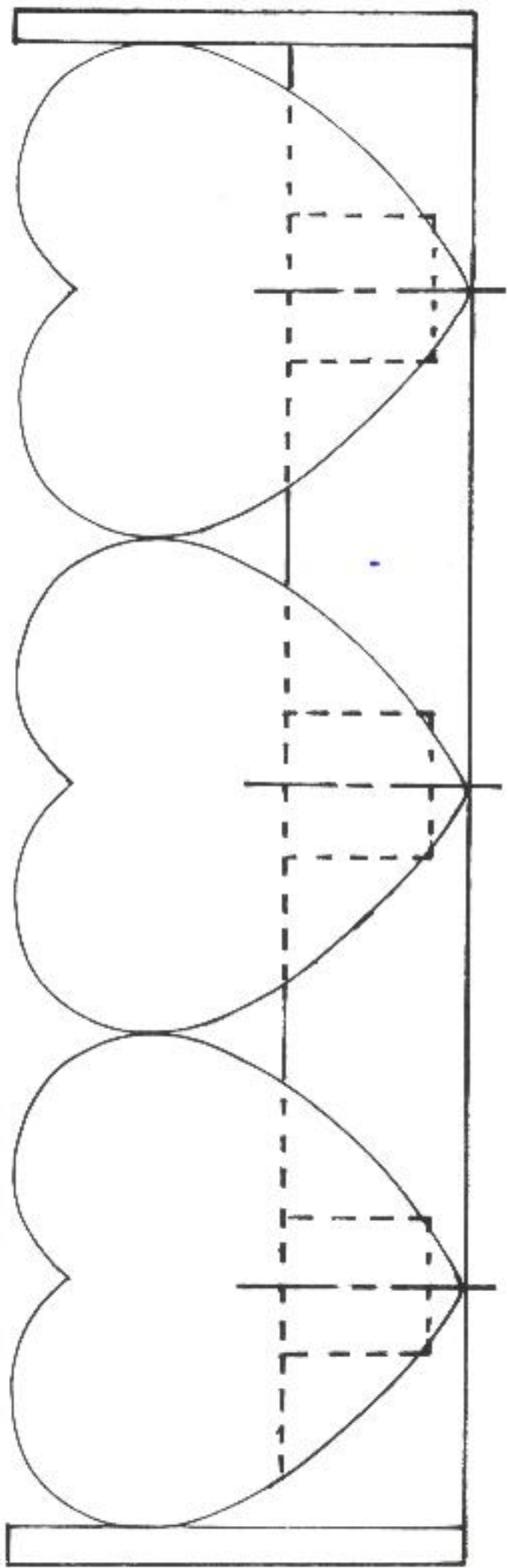

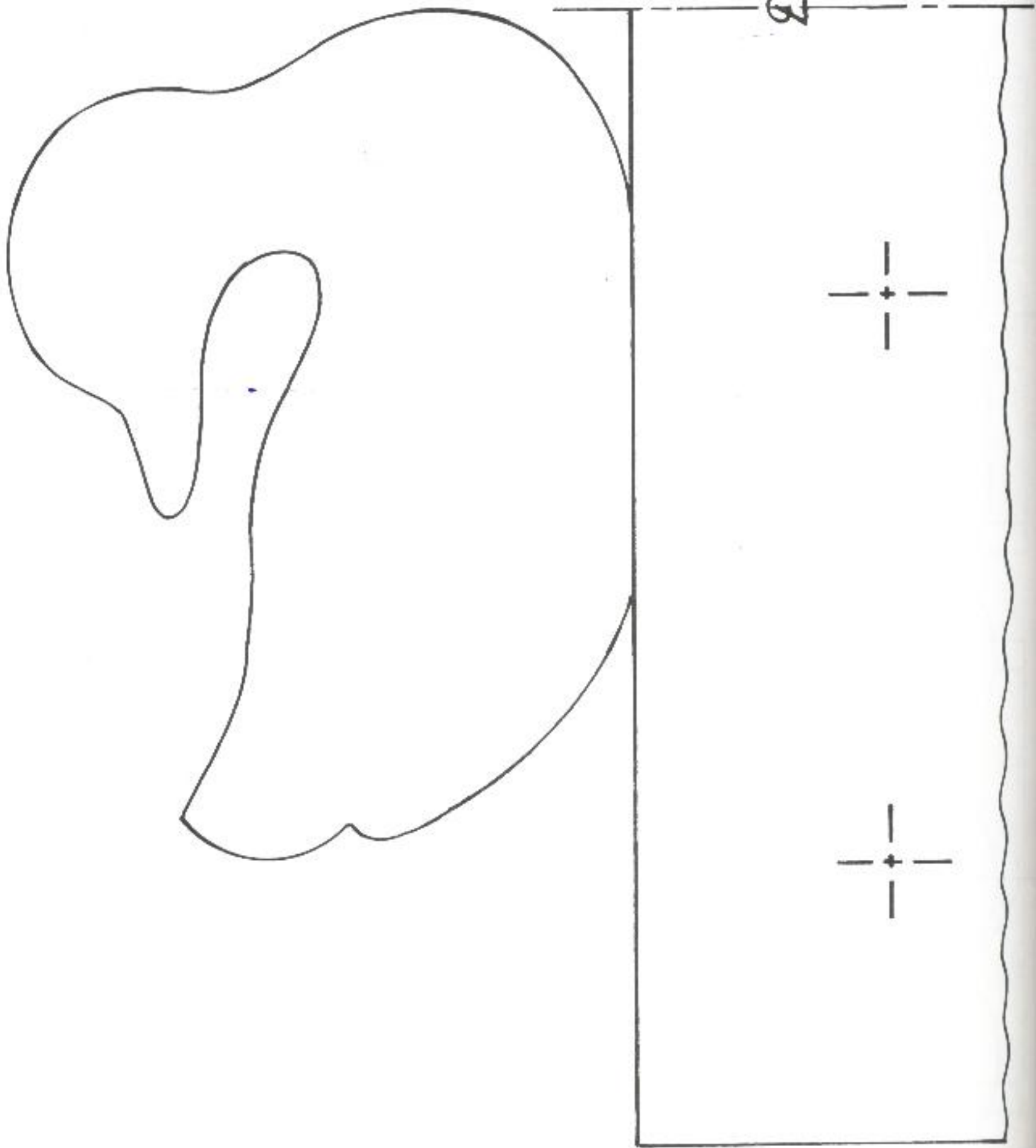

3



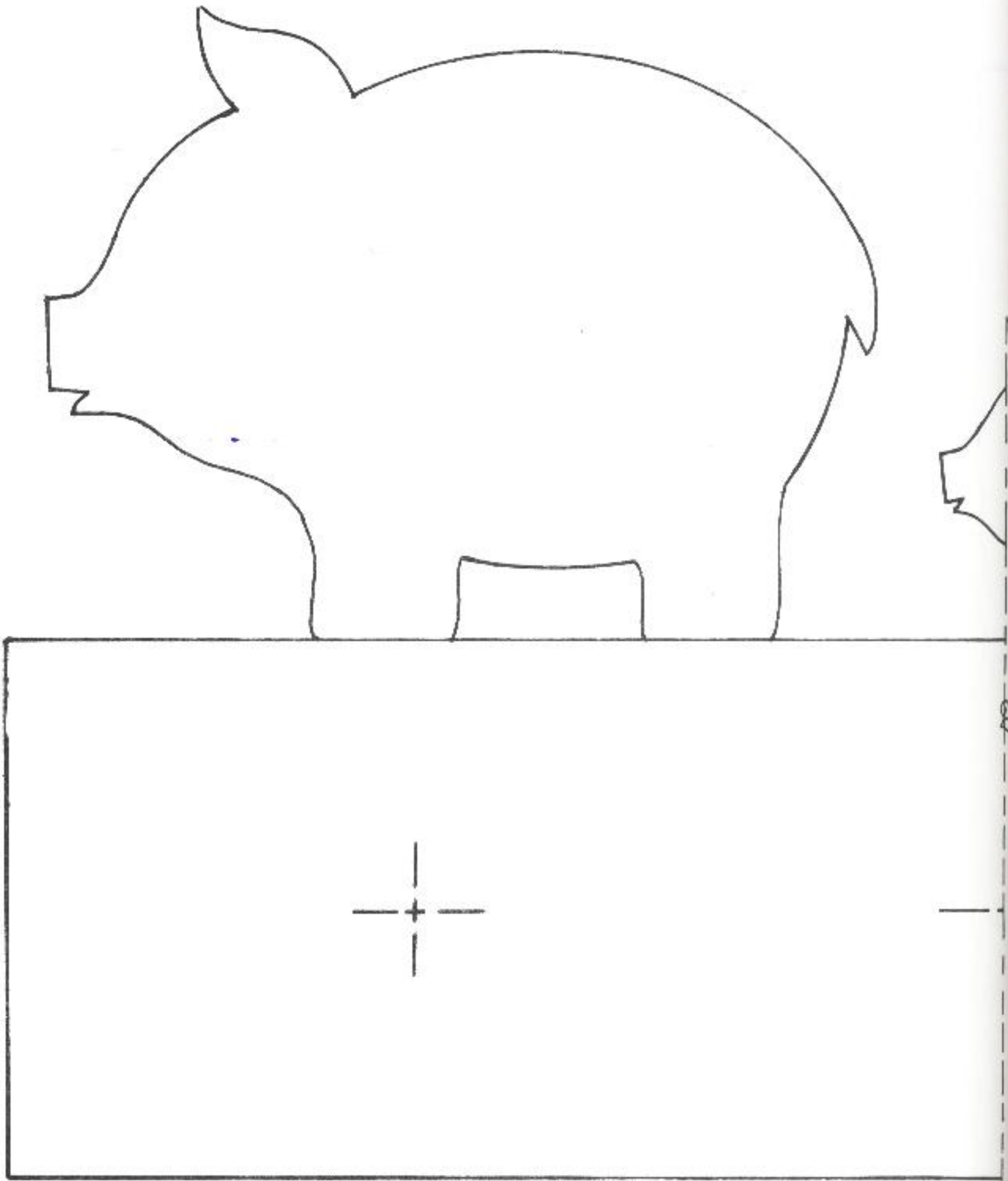

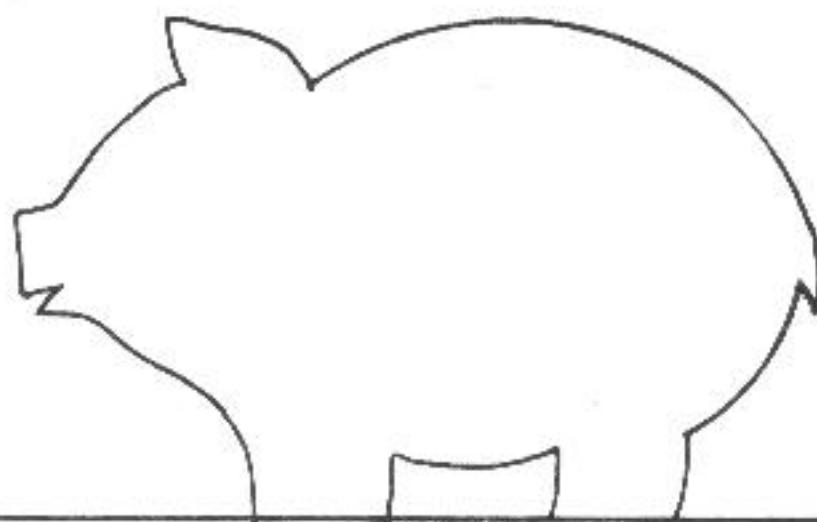
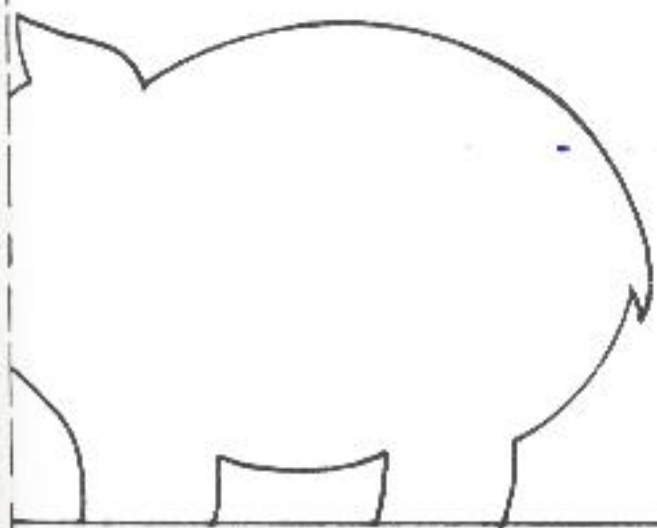

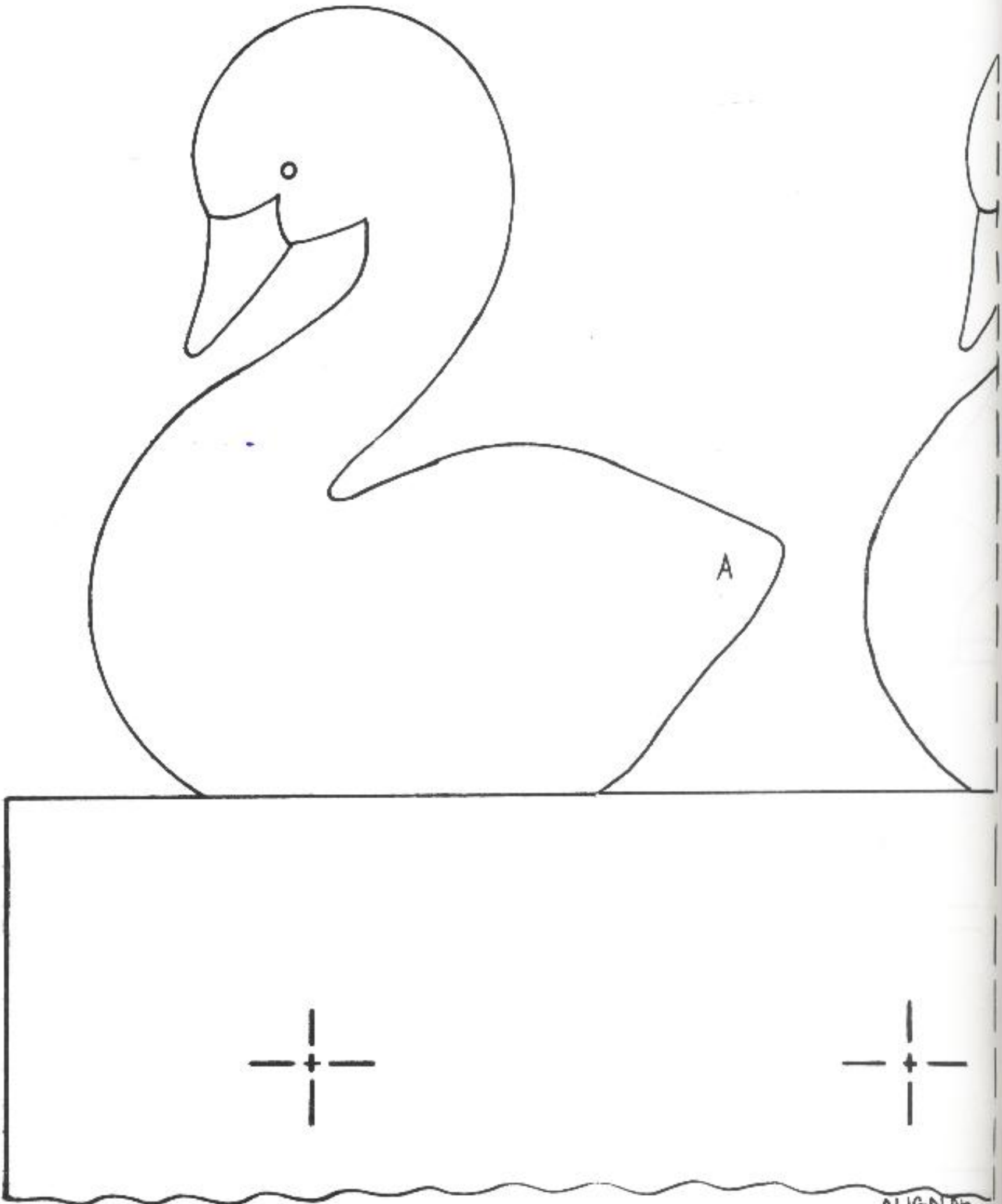



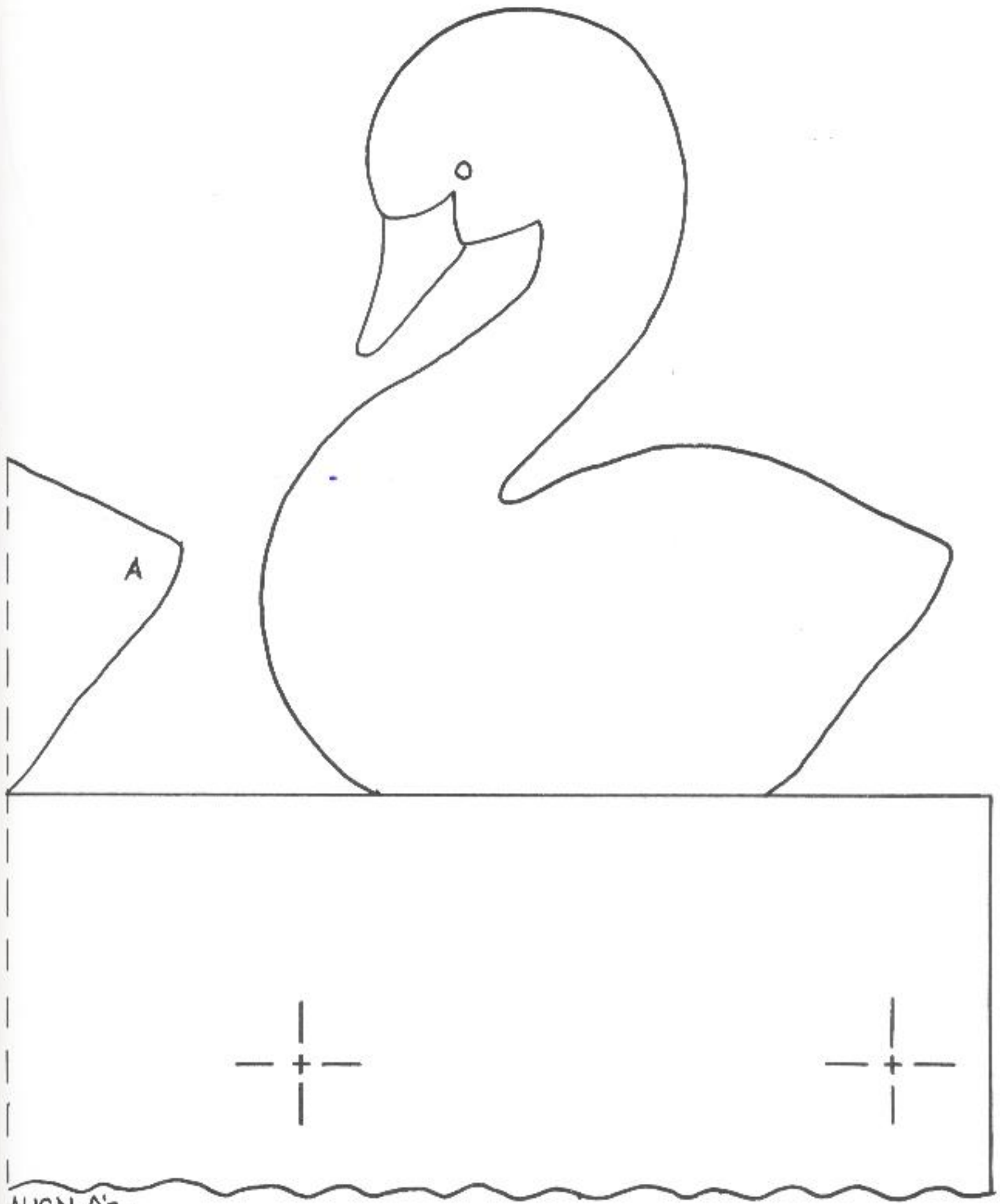

ALIGN A's.

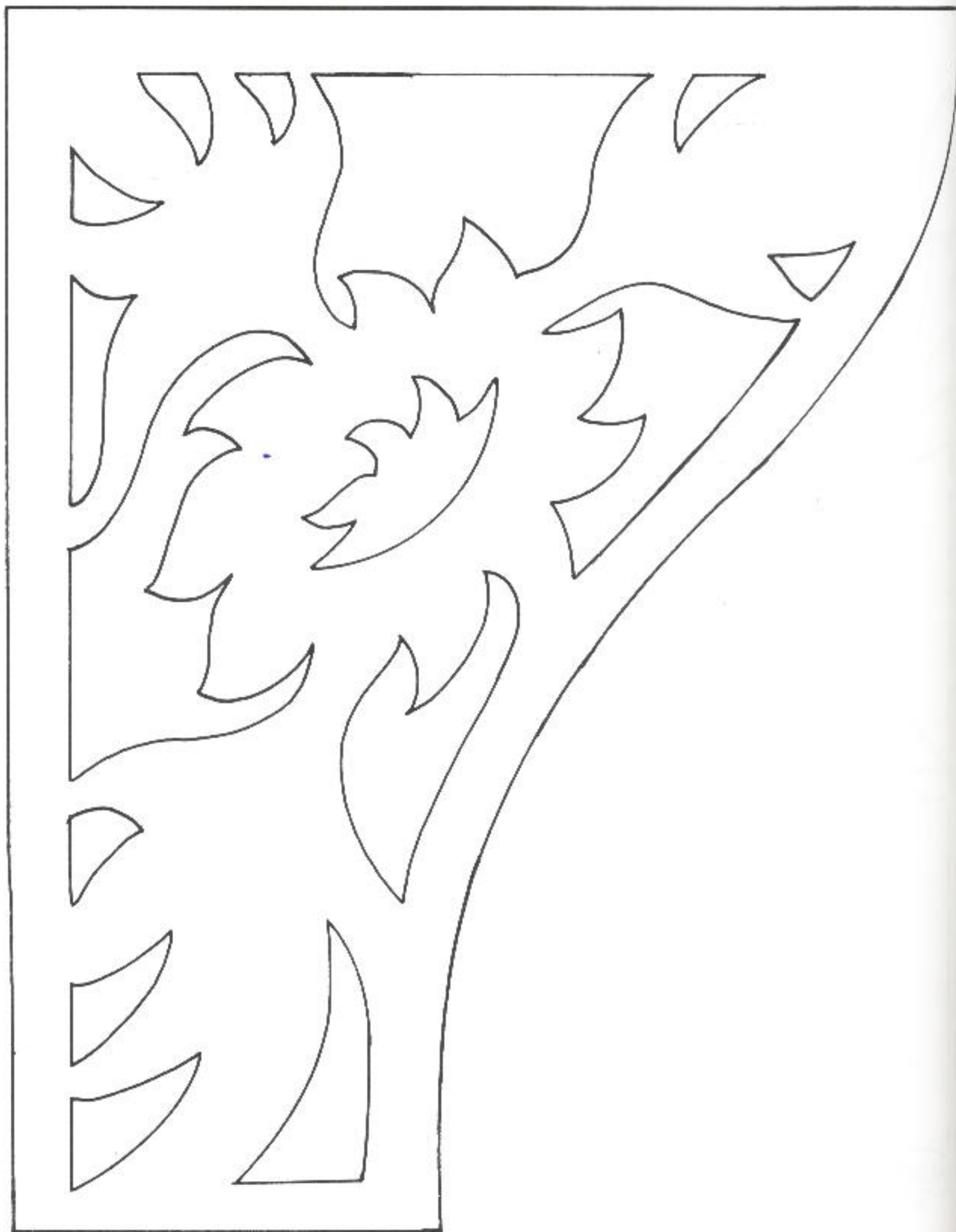

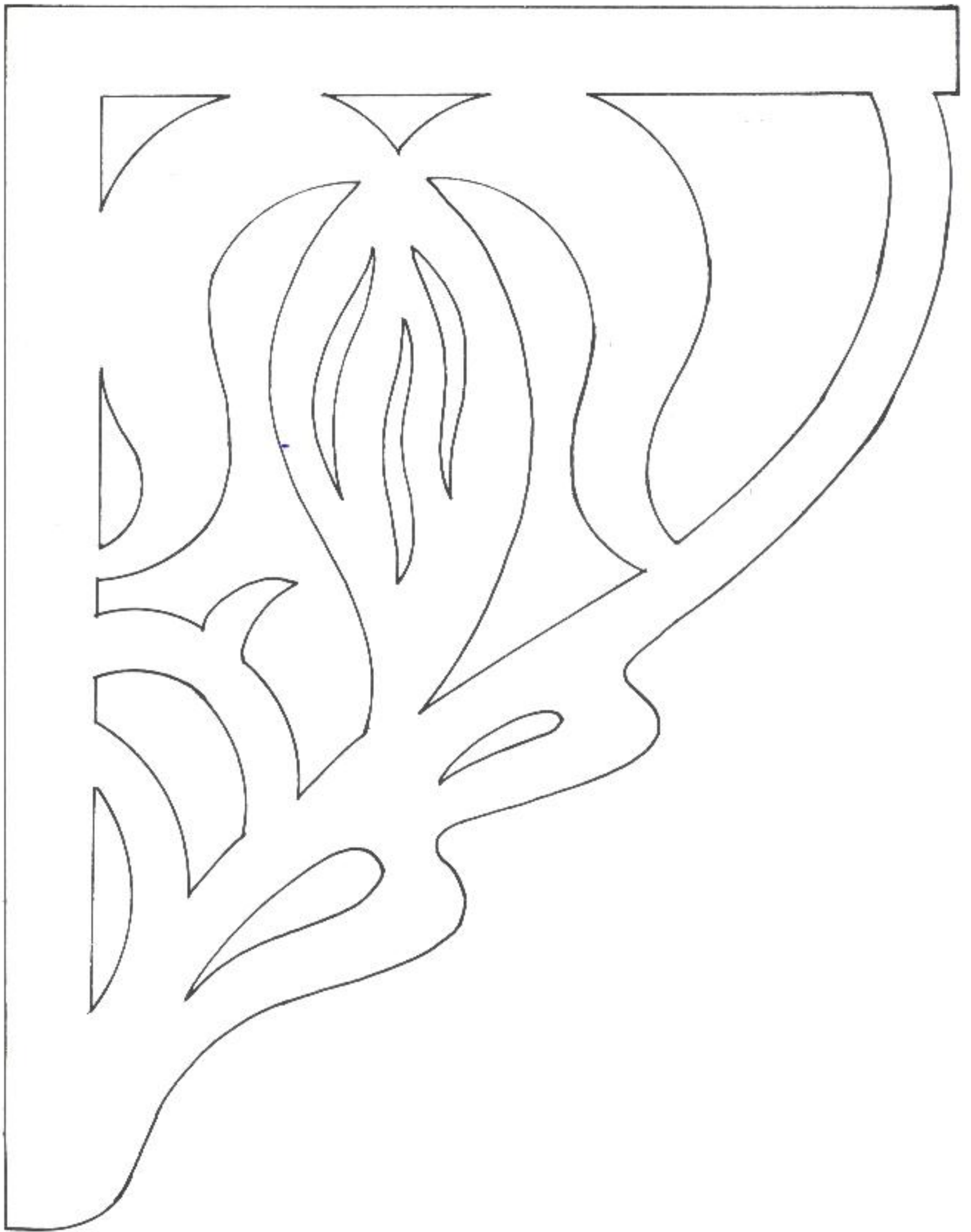

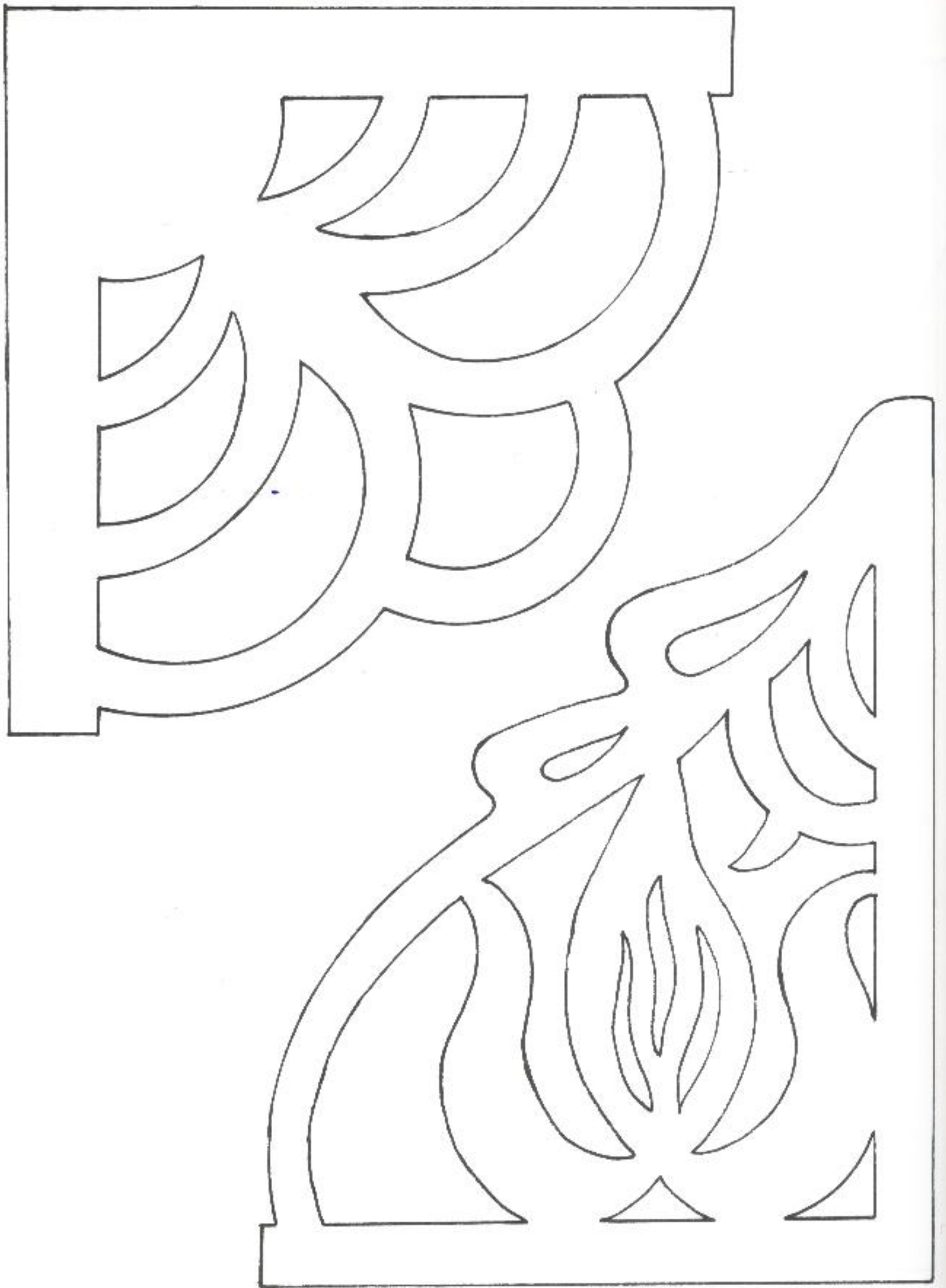



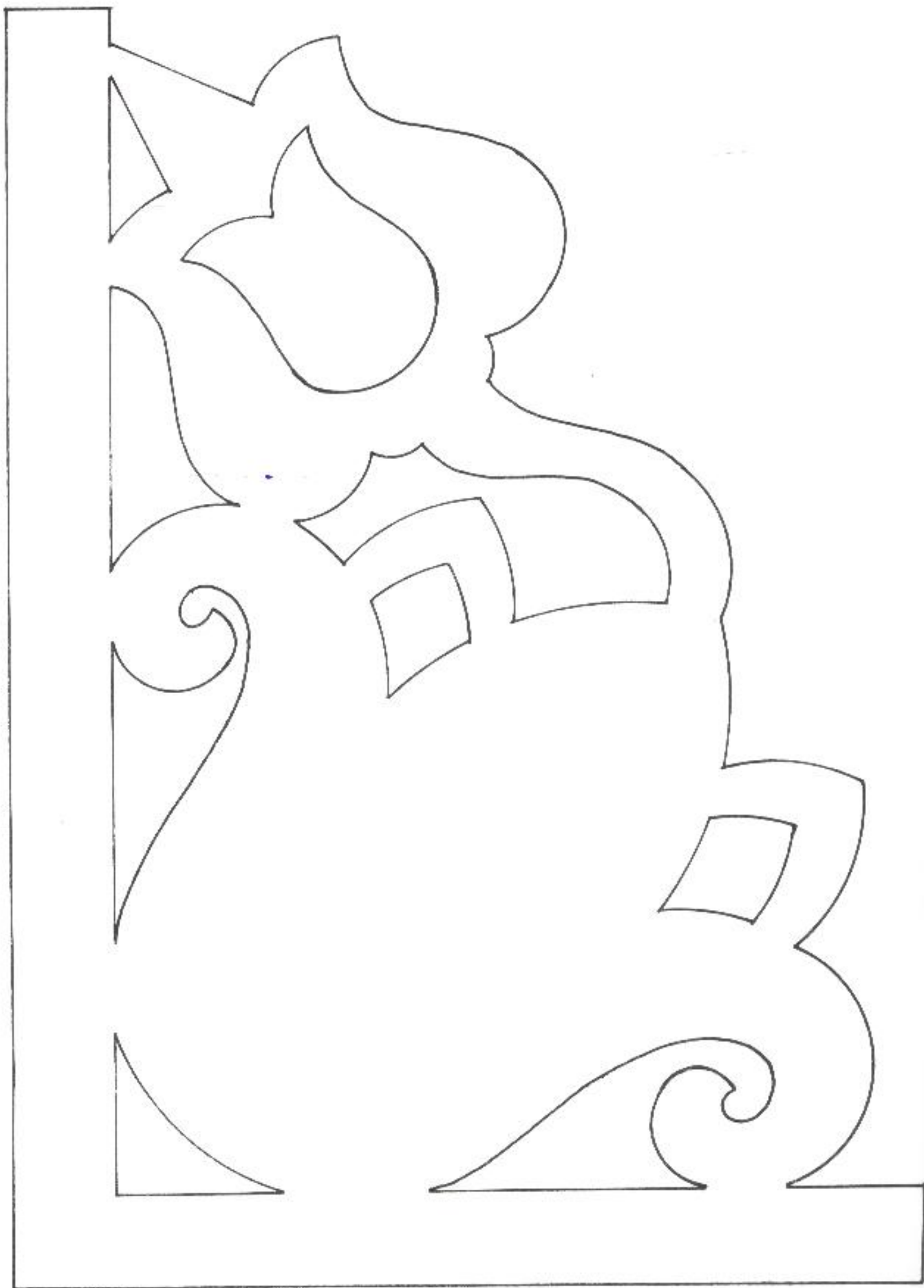

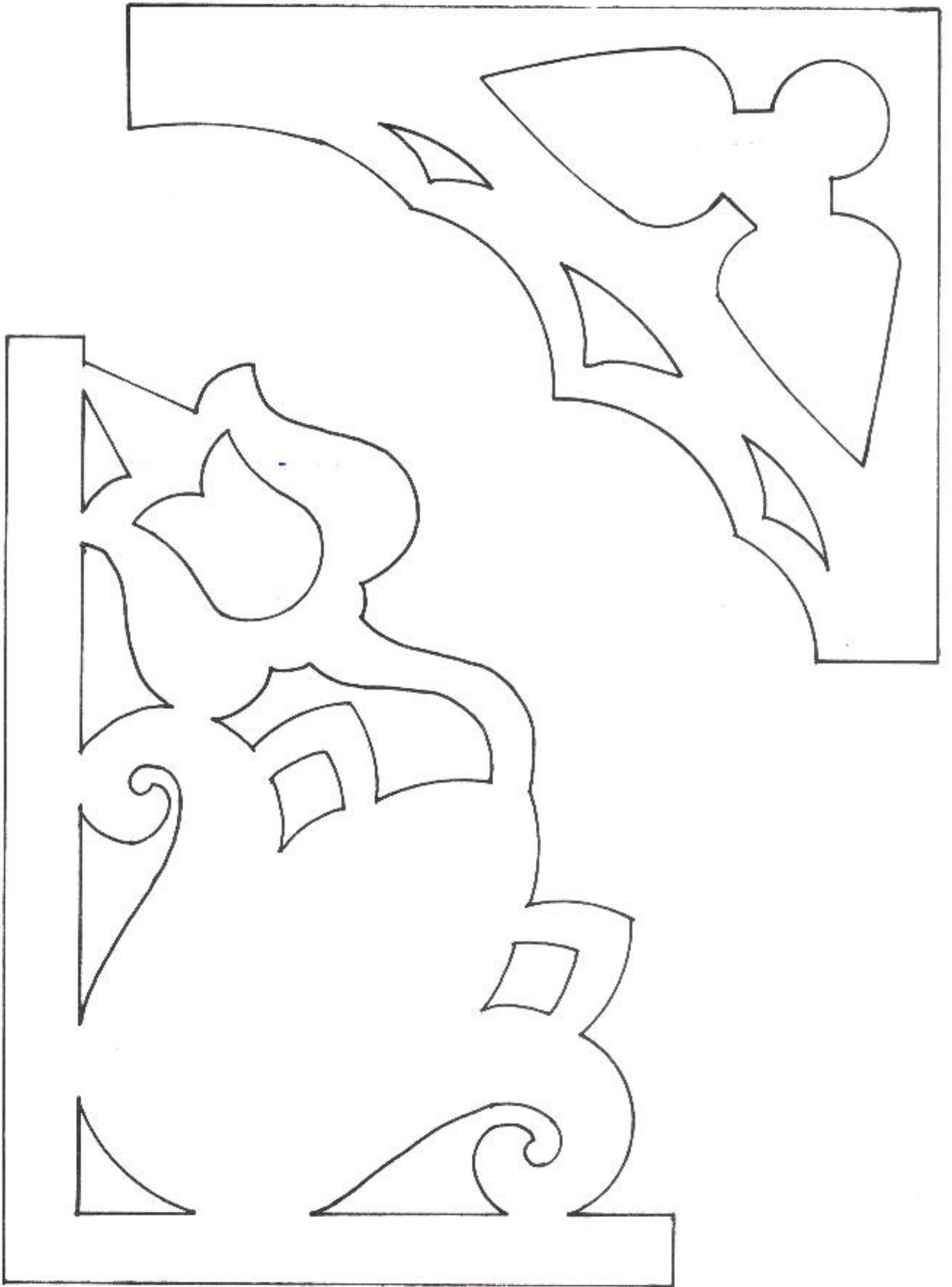





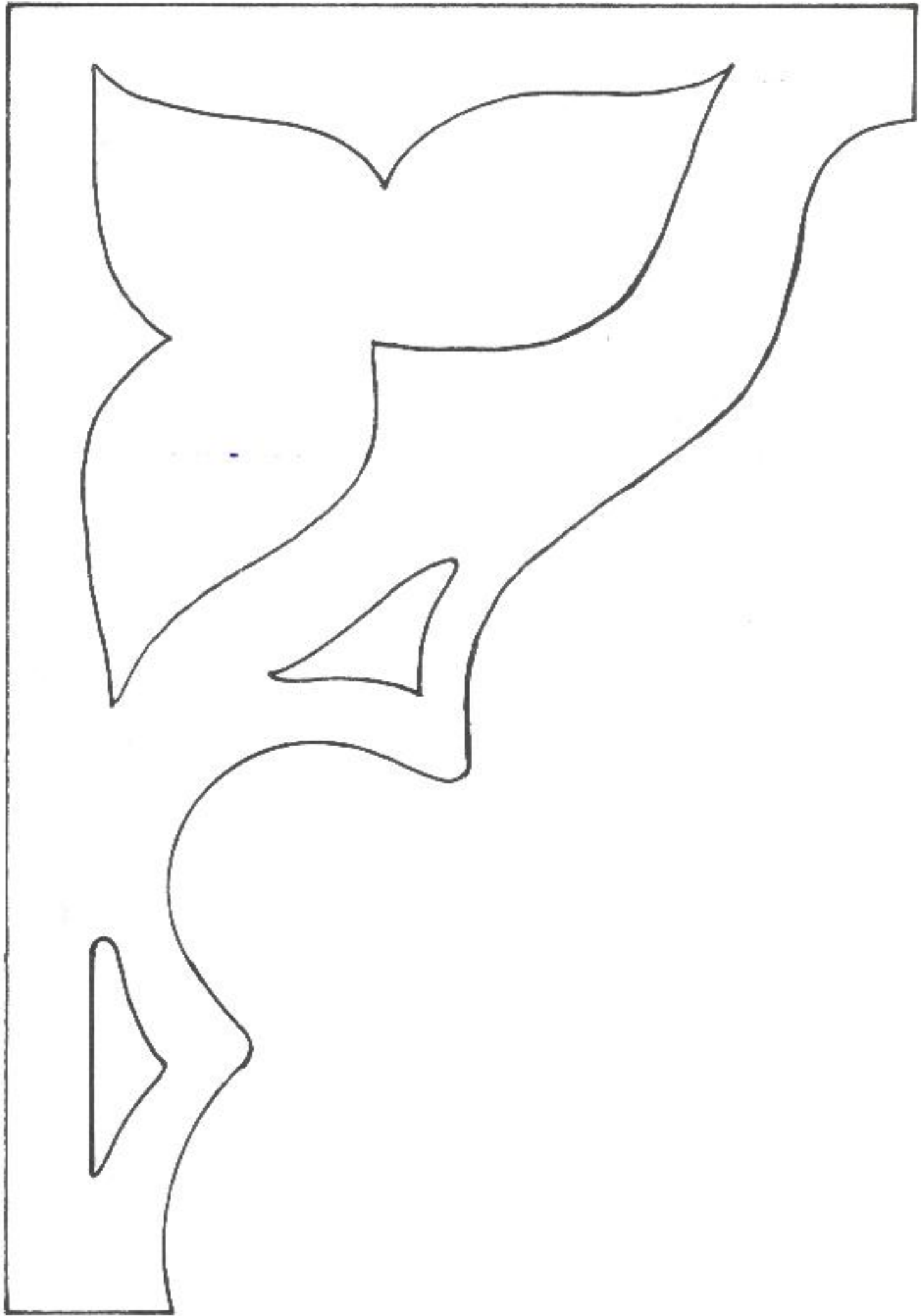

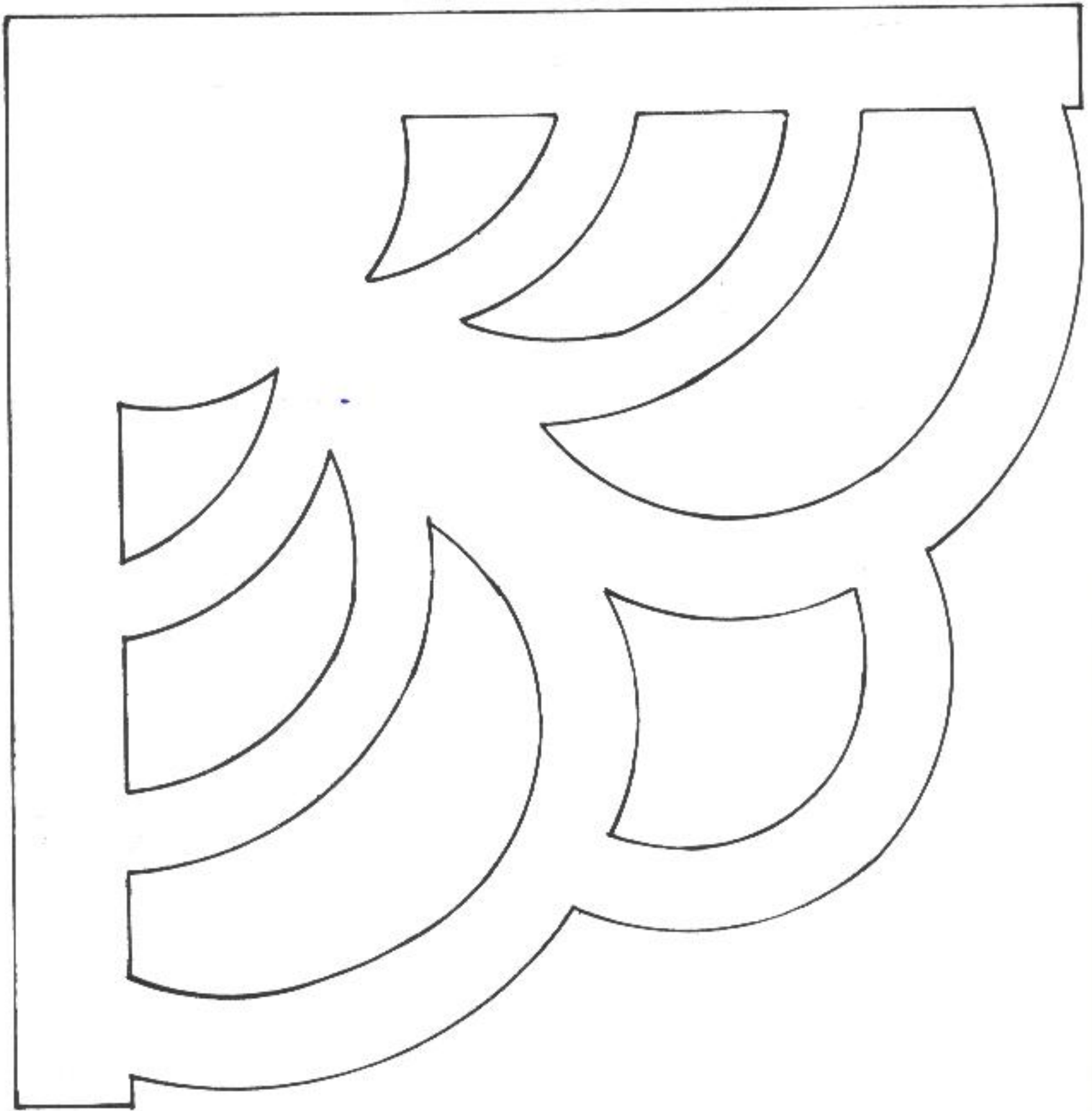

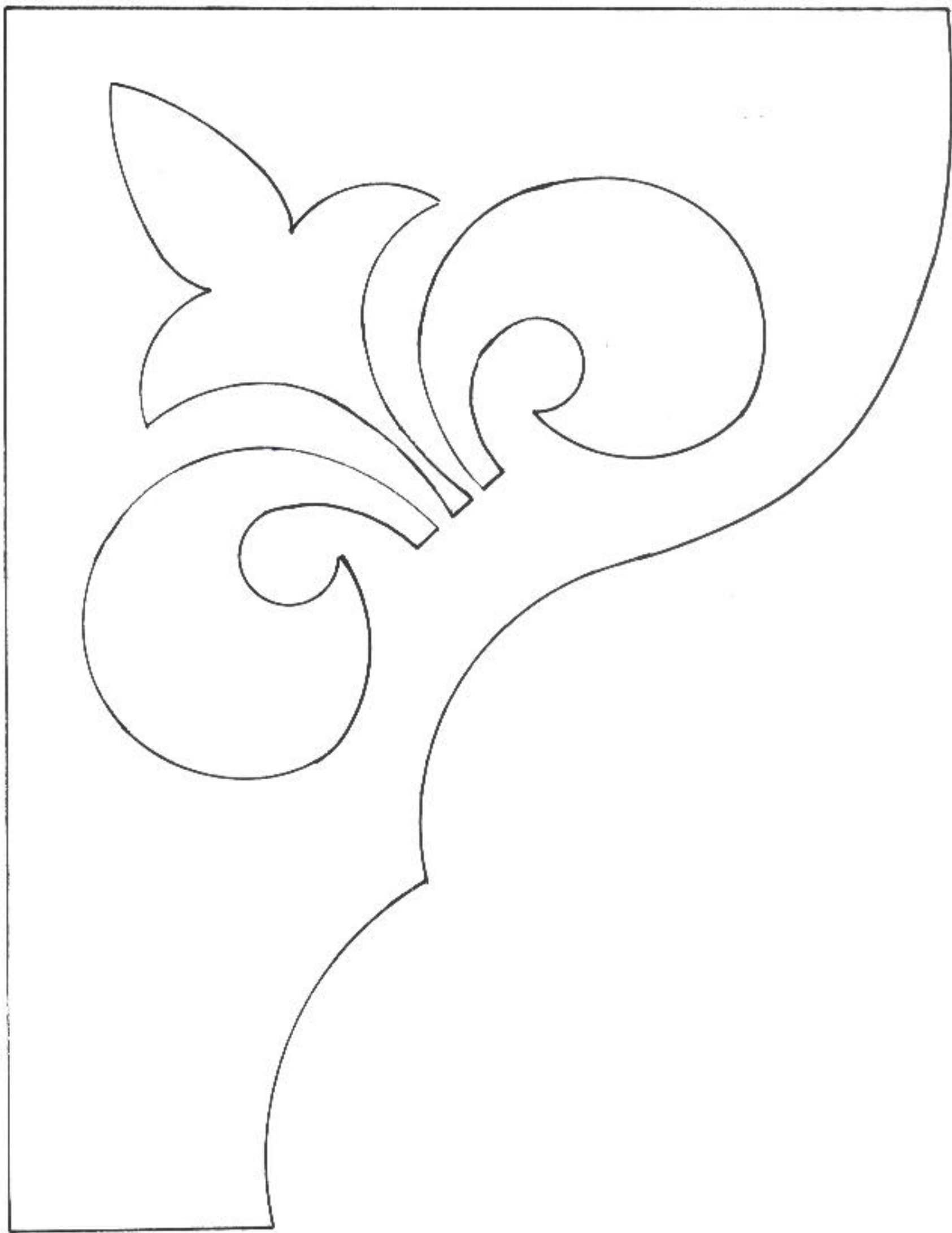



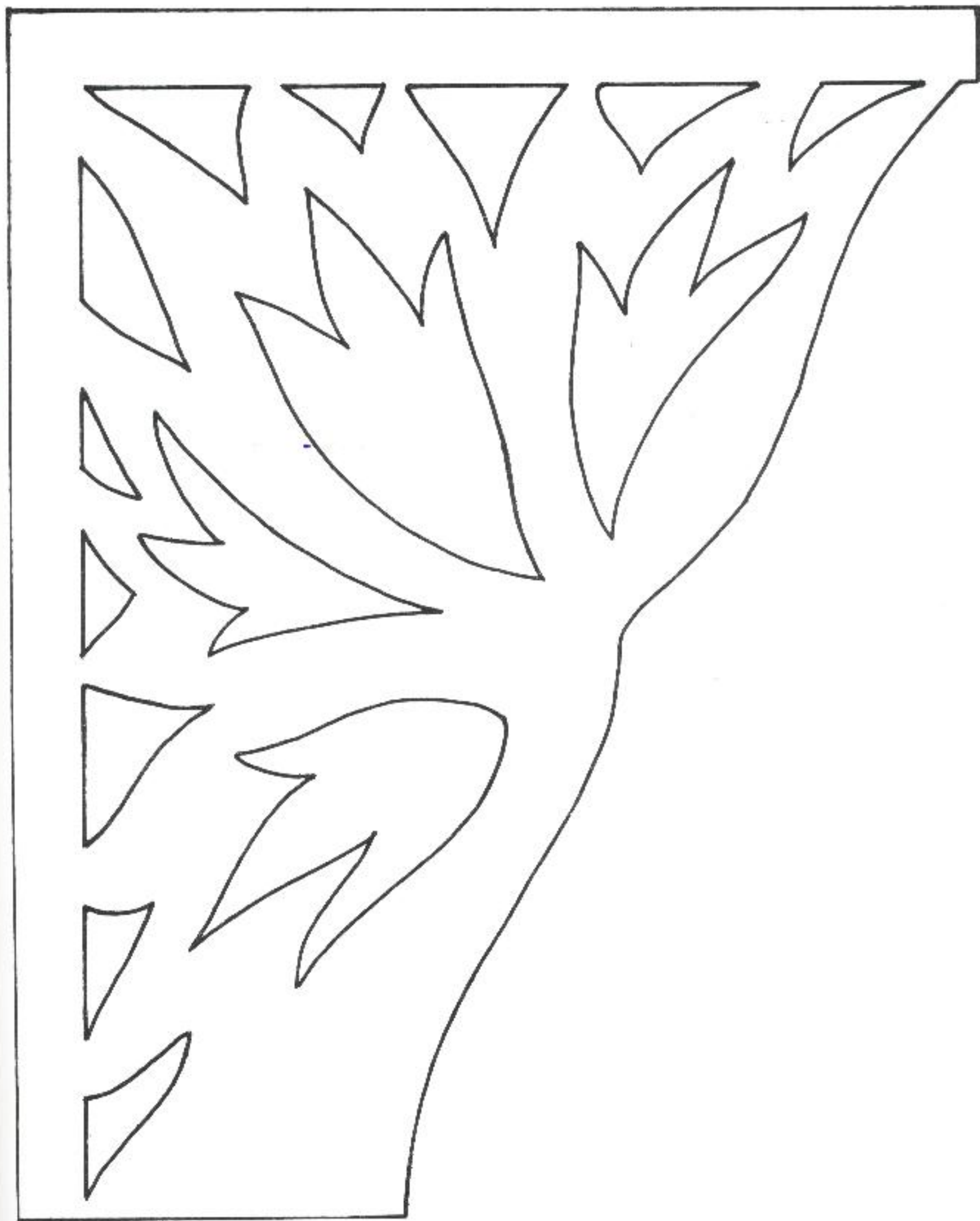

# Picture Frames/Shelves

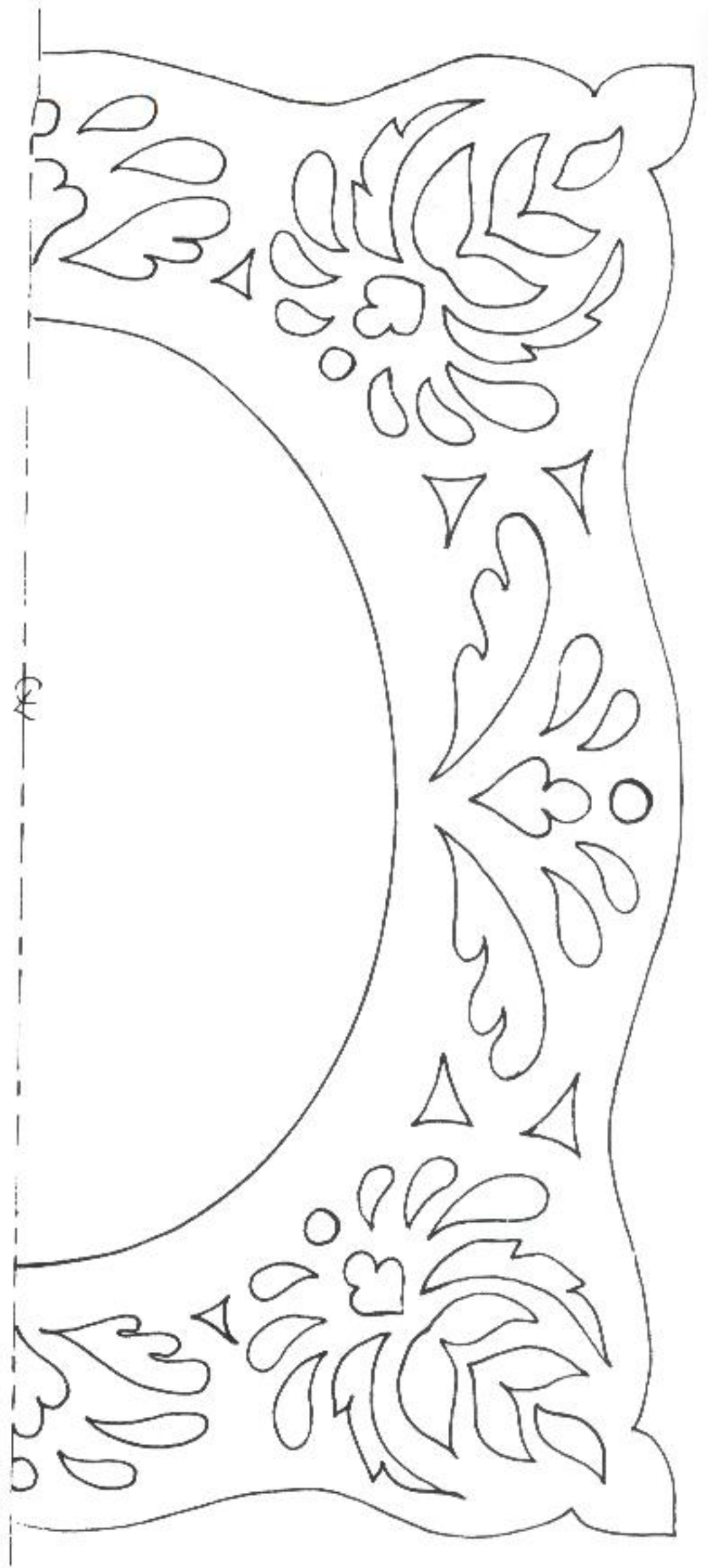

*This pattern is half-size.  
The frame opening is 4 x 5.*

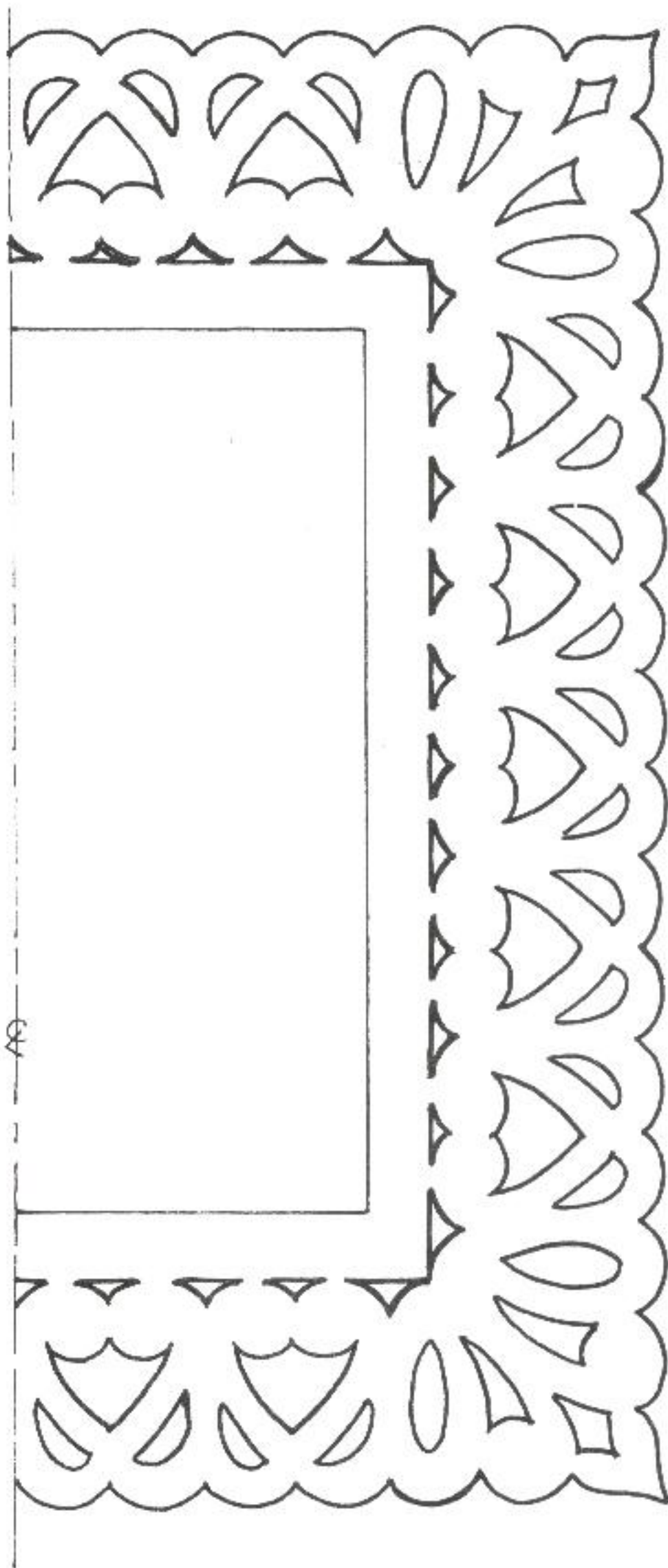

*This fretwork shelf is made with 3/8-inch material.*

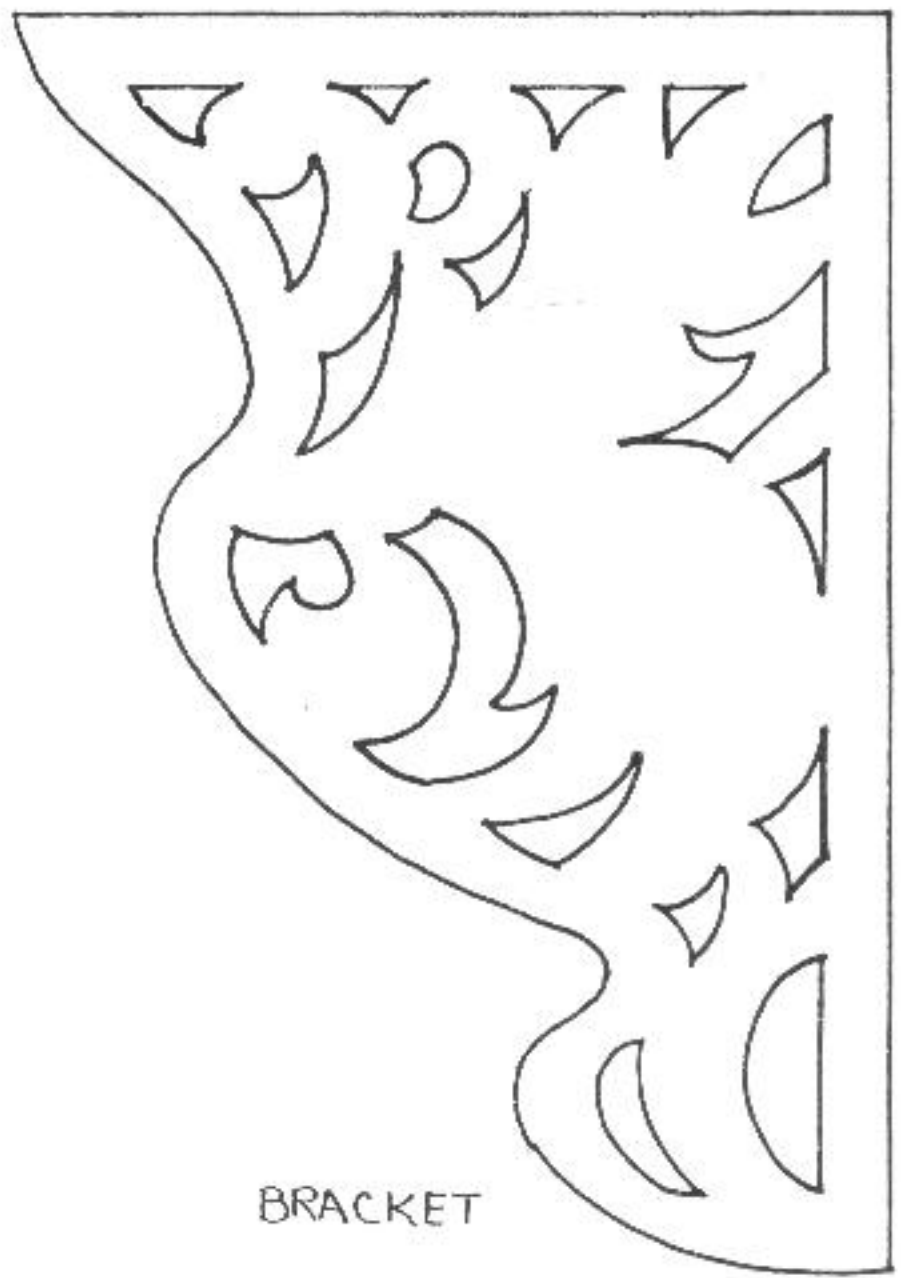

BRACKET

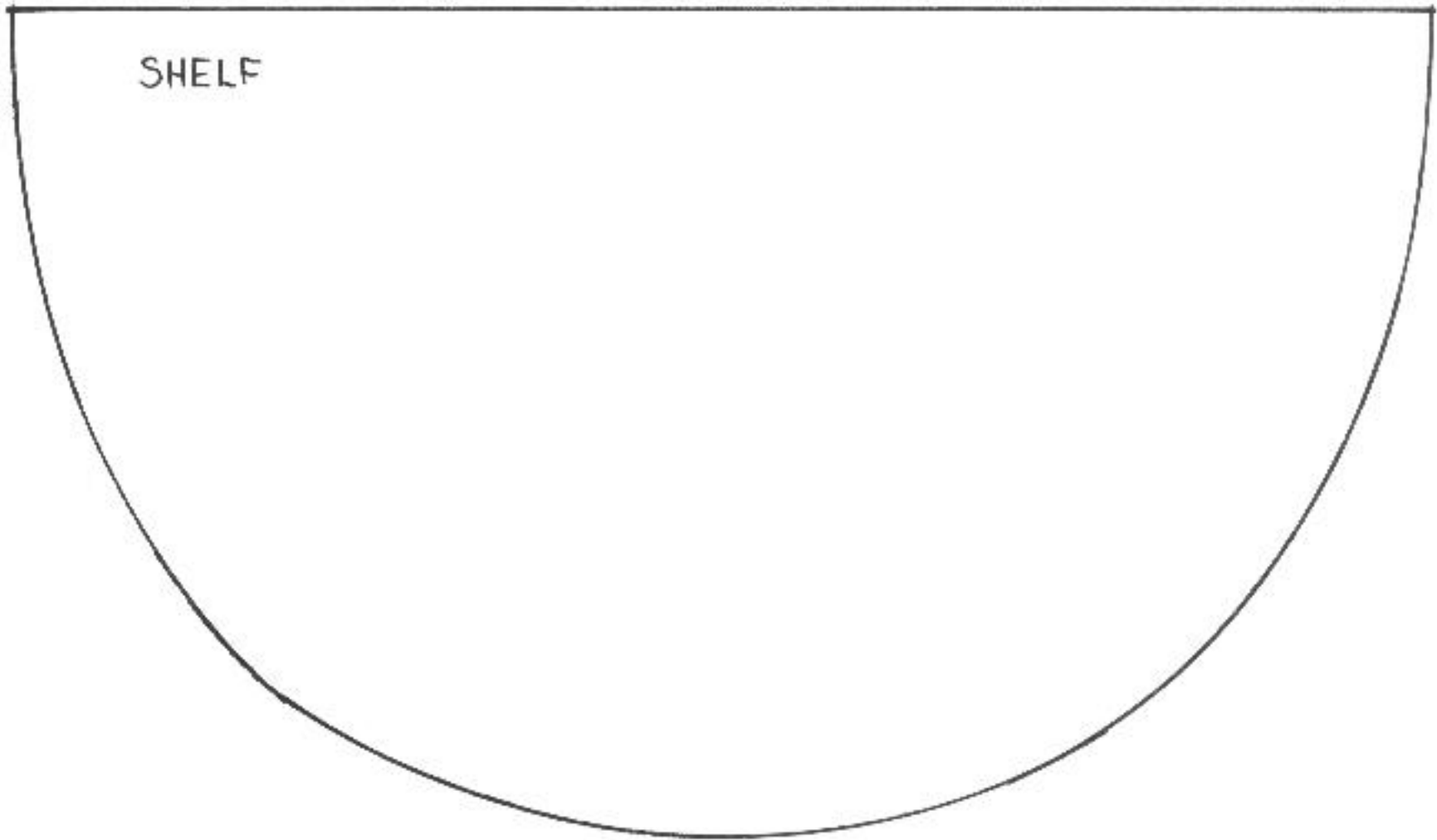

SHELF



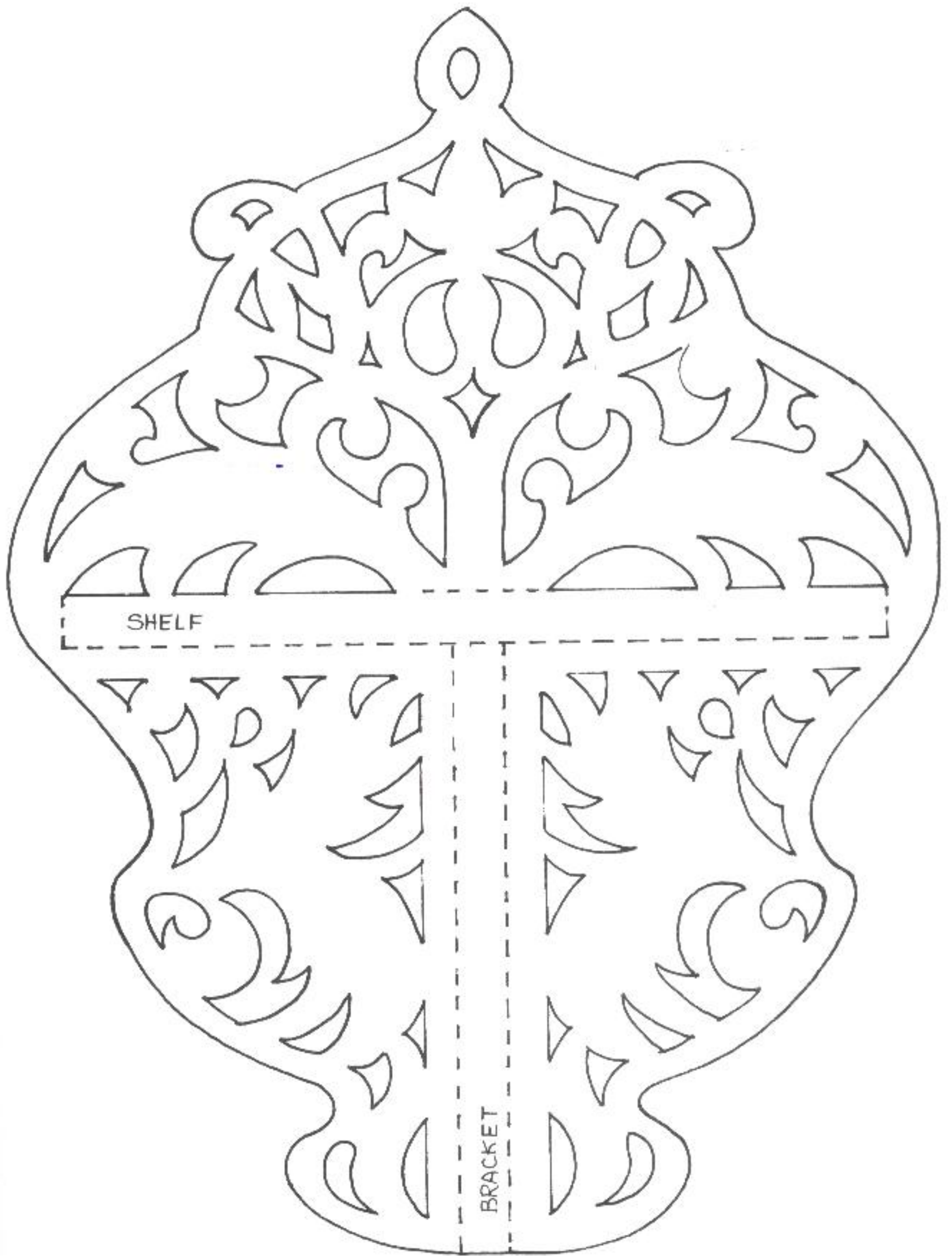

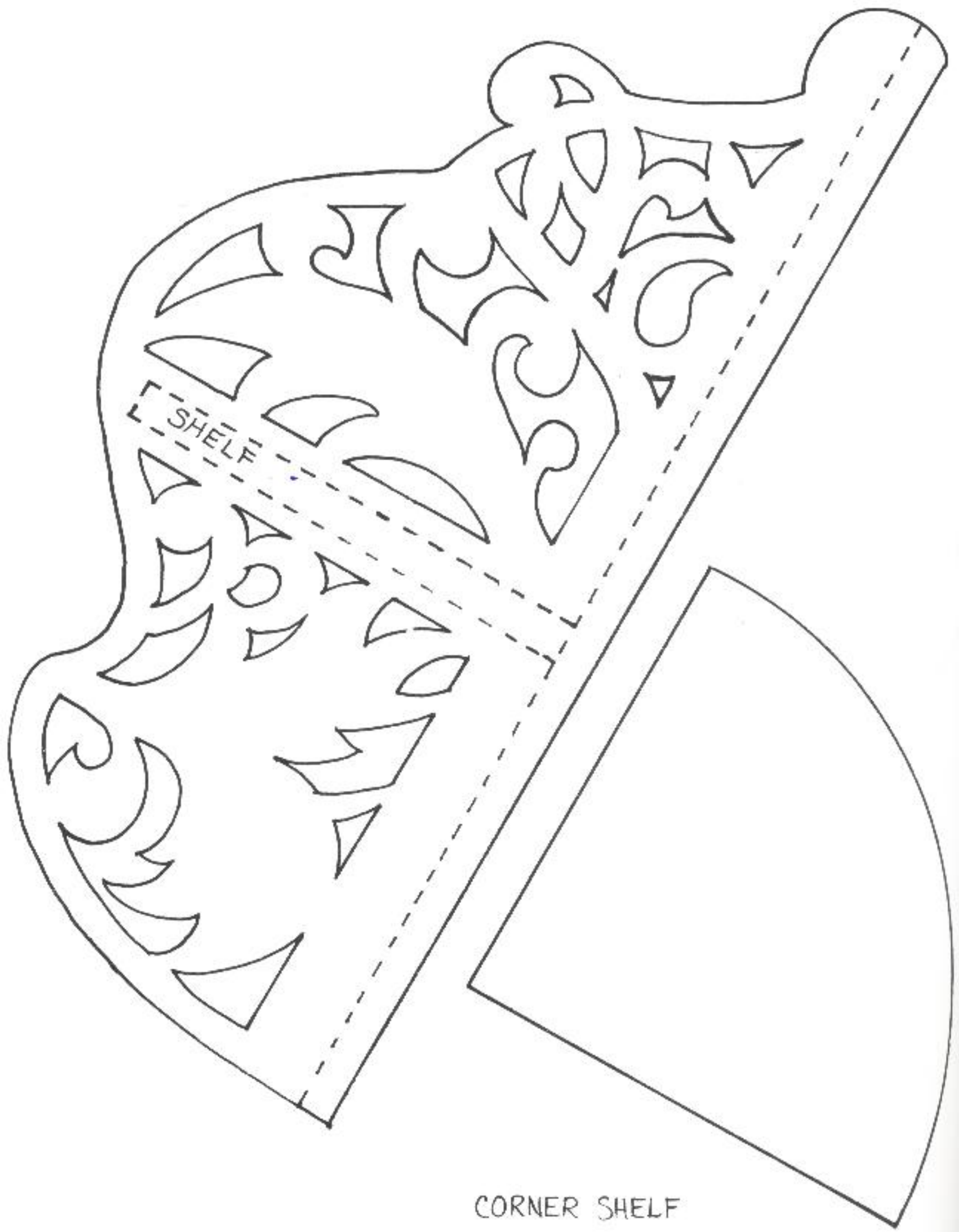

### CORNER SHELF

*This corner shelf is made with 1/4-inch plywood.*

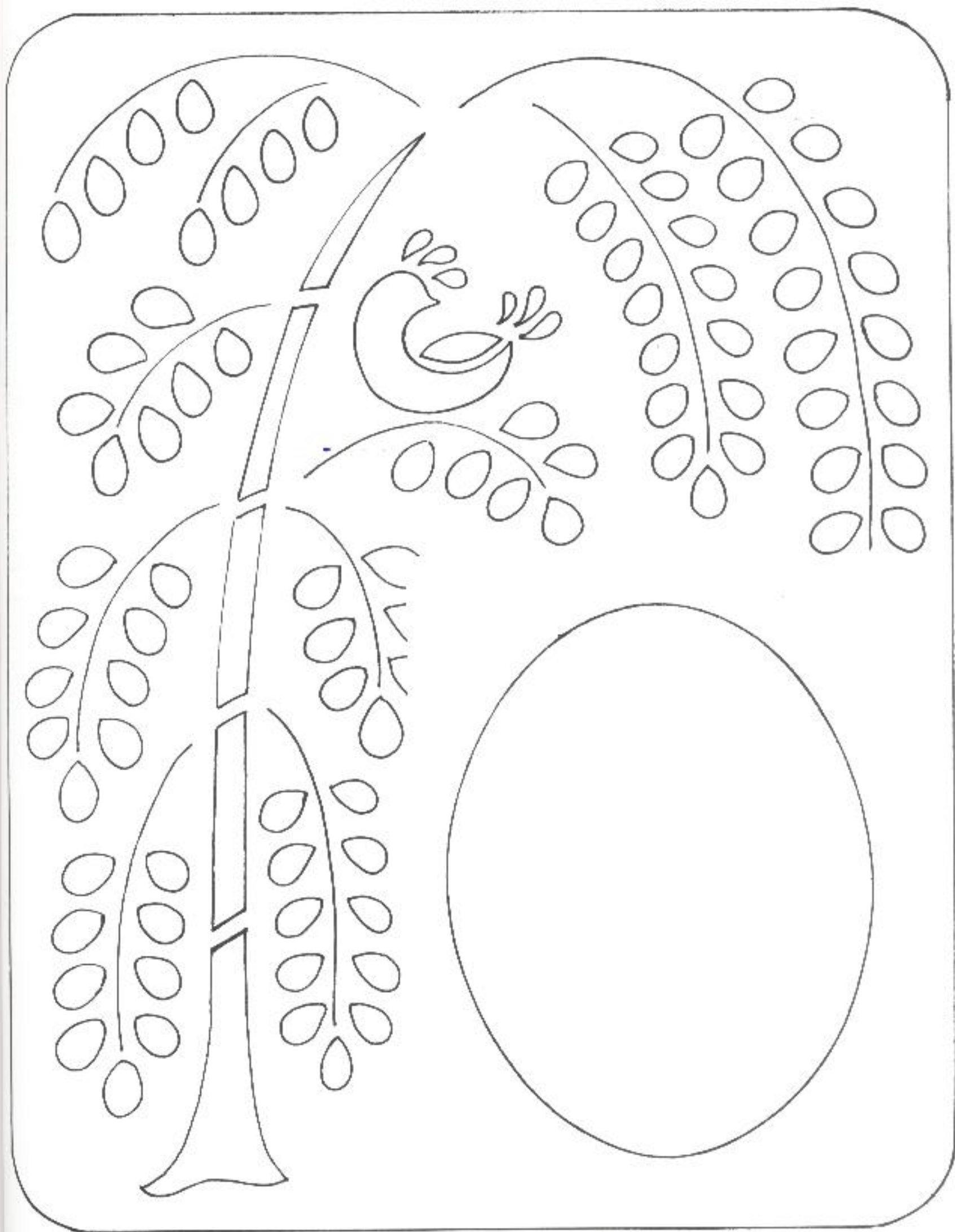

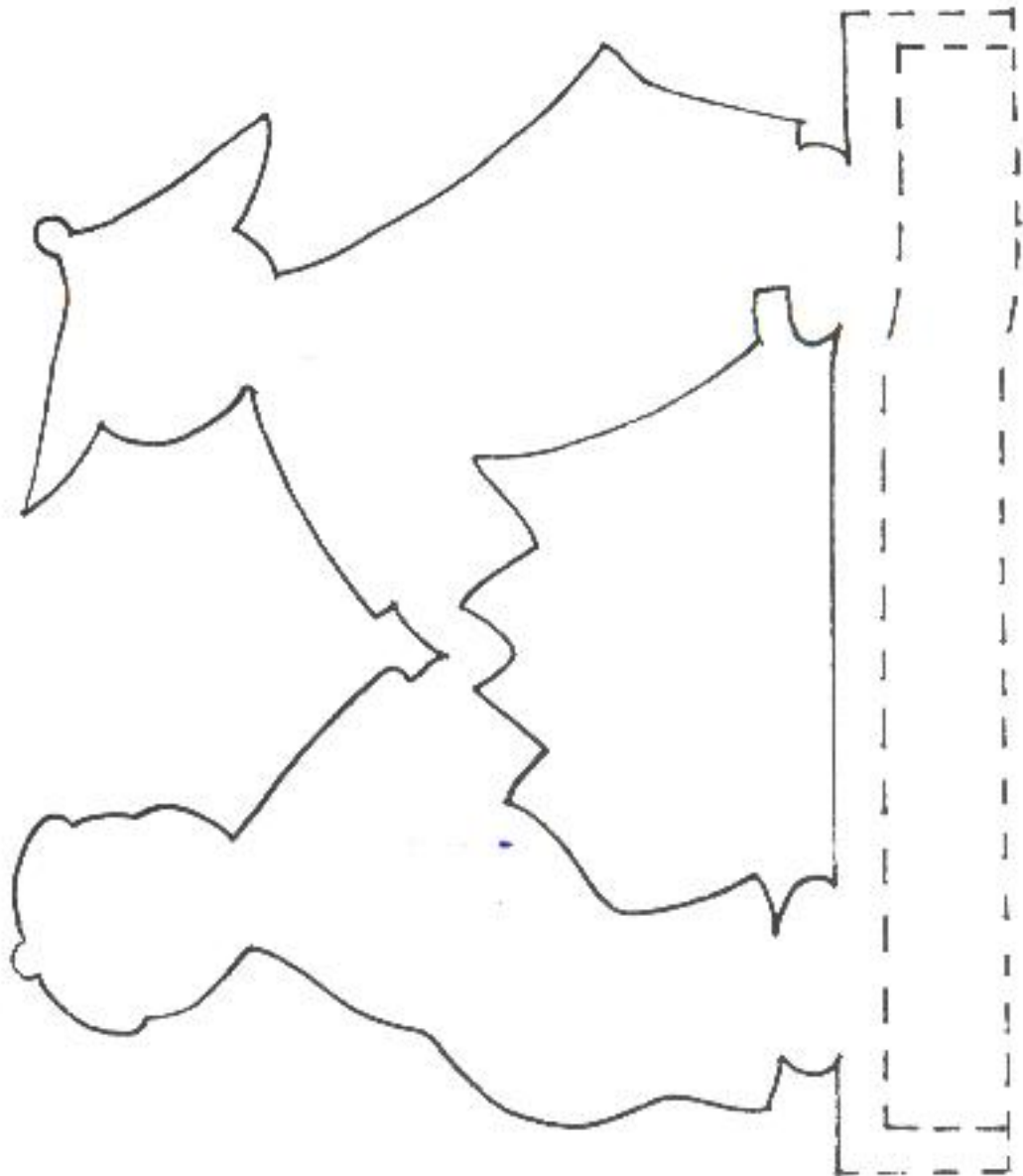

ALTERNATE SHELF DESIGNS

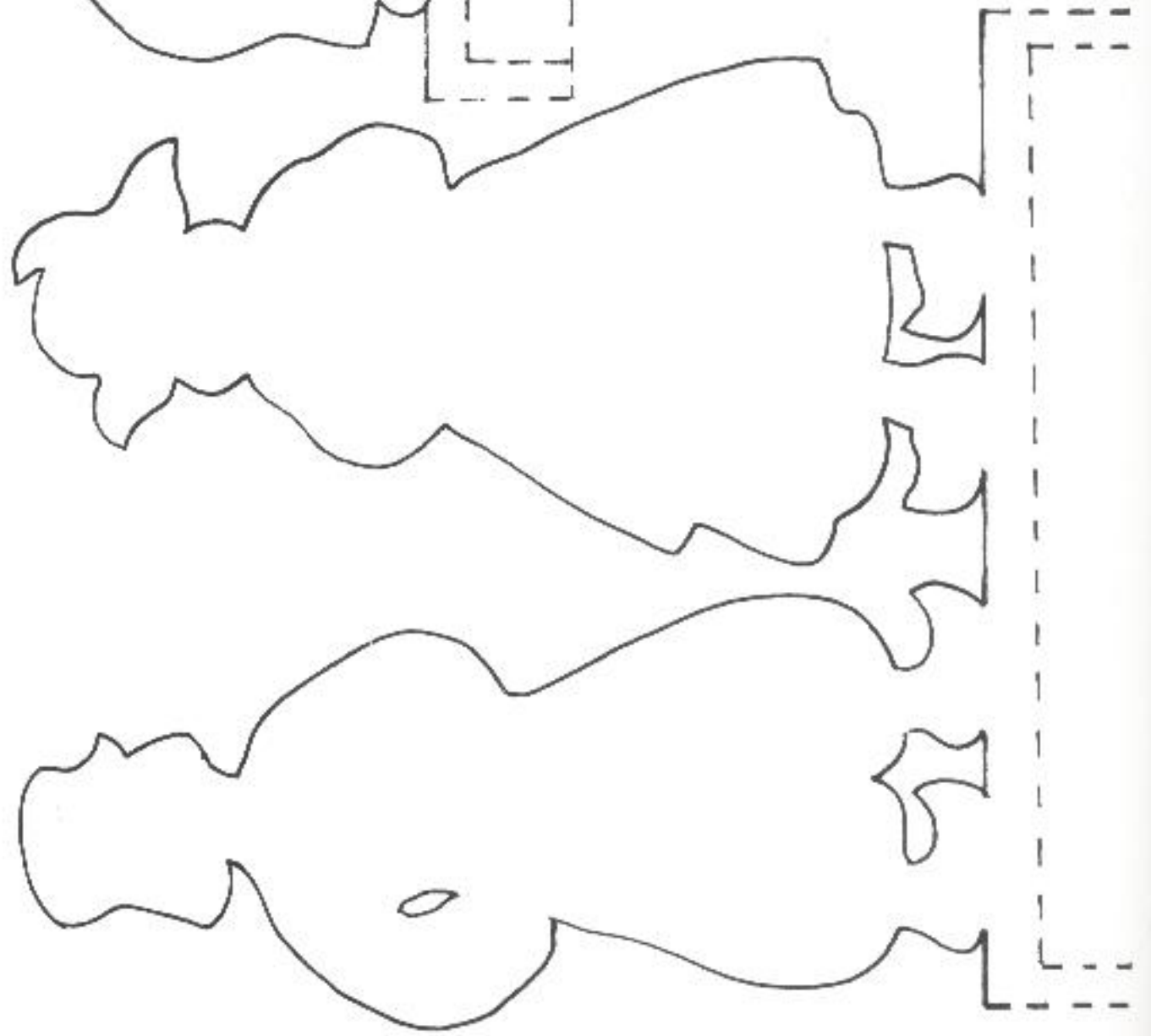

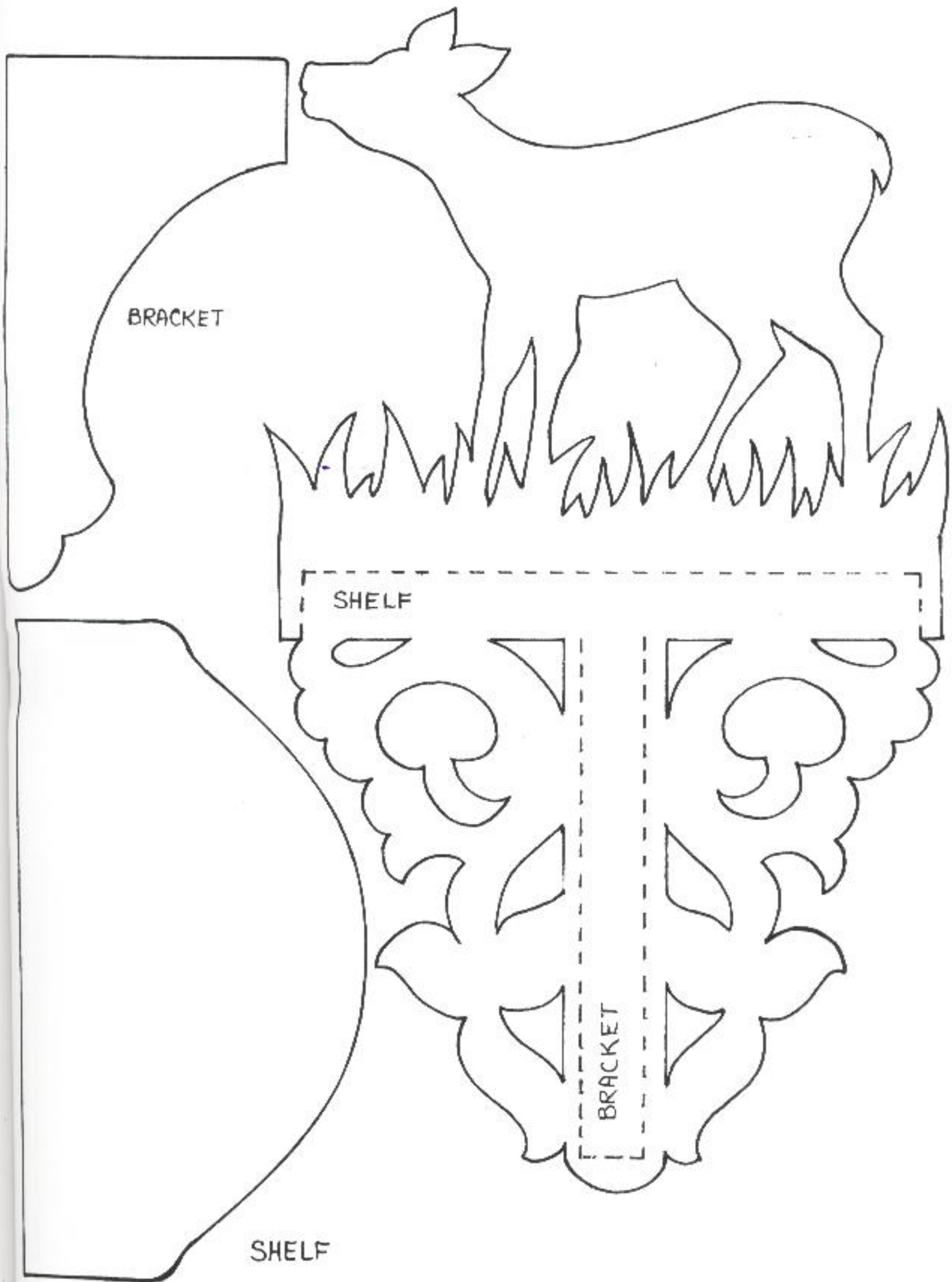

# Recess/Relief/Silhouette/Line Work

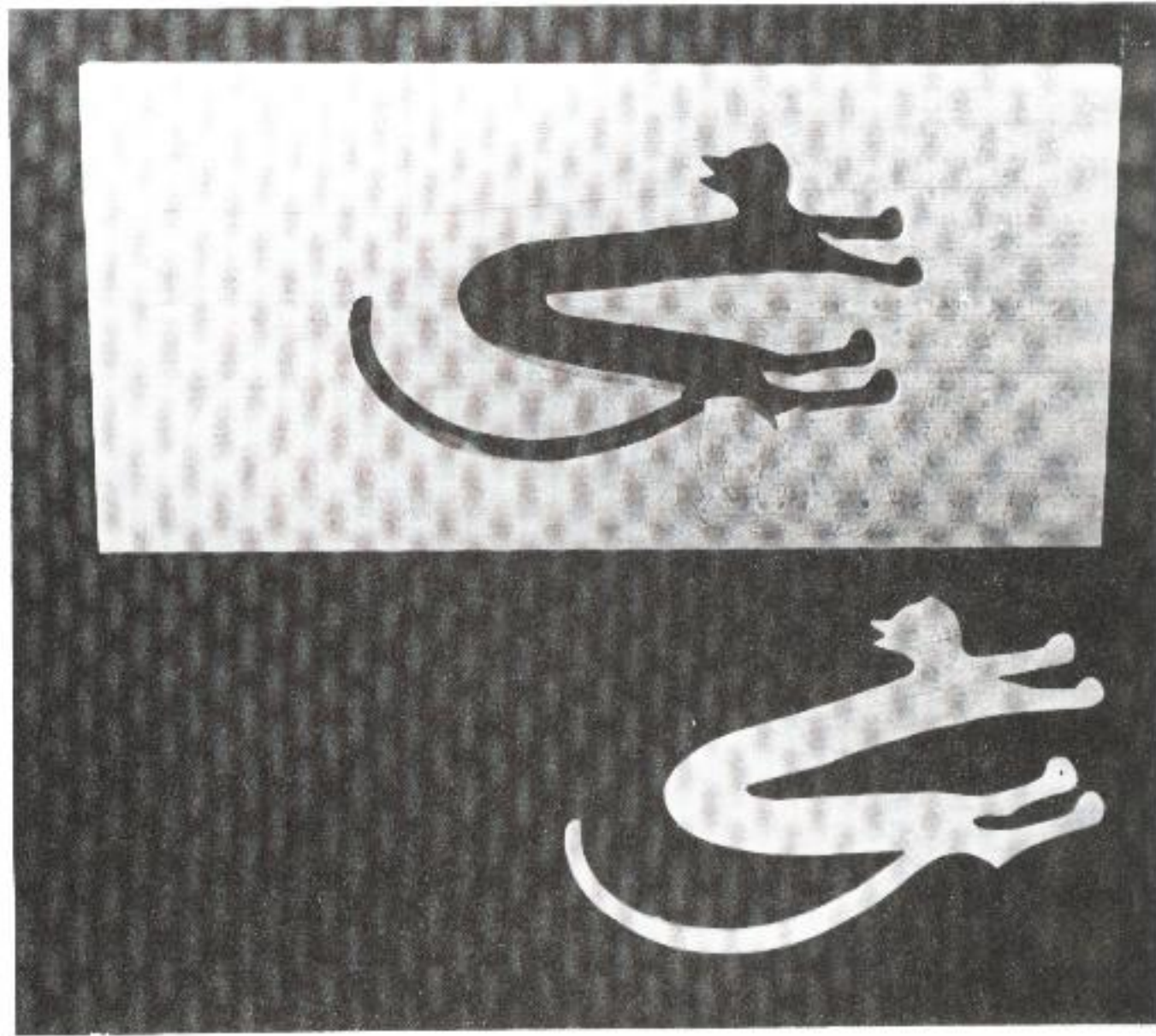

Simple cutout.

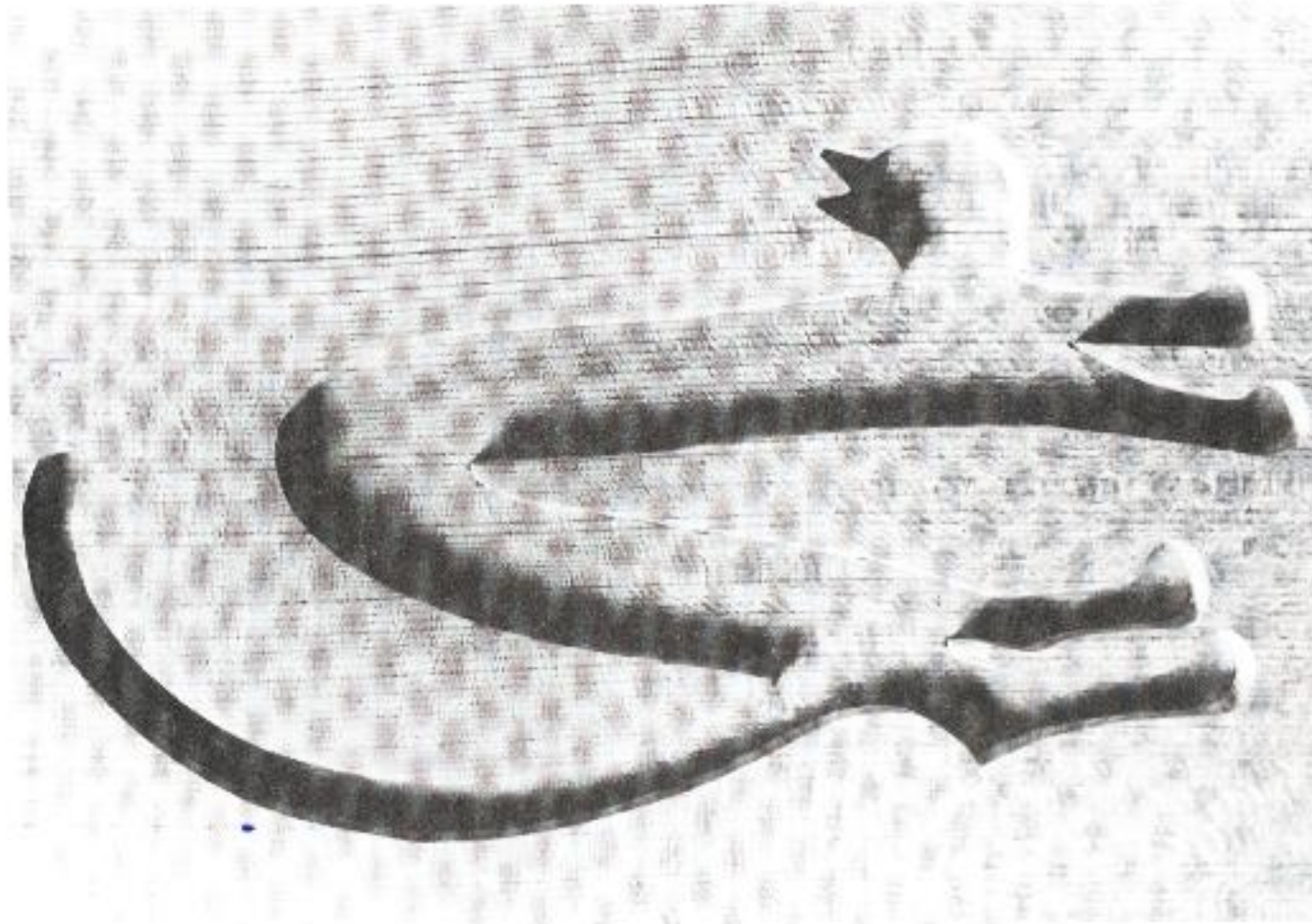

Recessed design. (See the Scroll Saw Handbook for a discussion of the technique.)

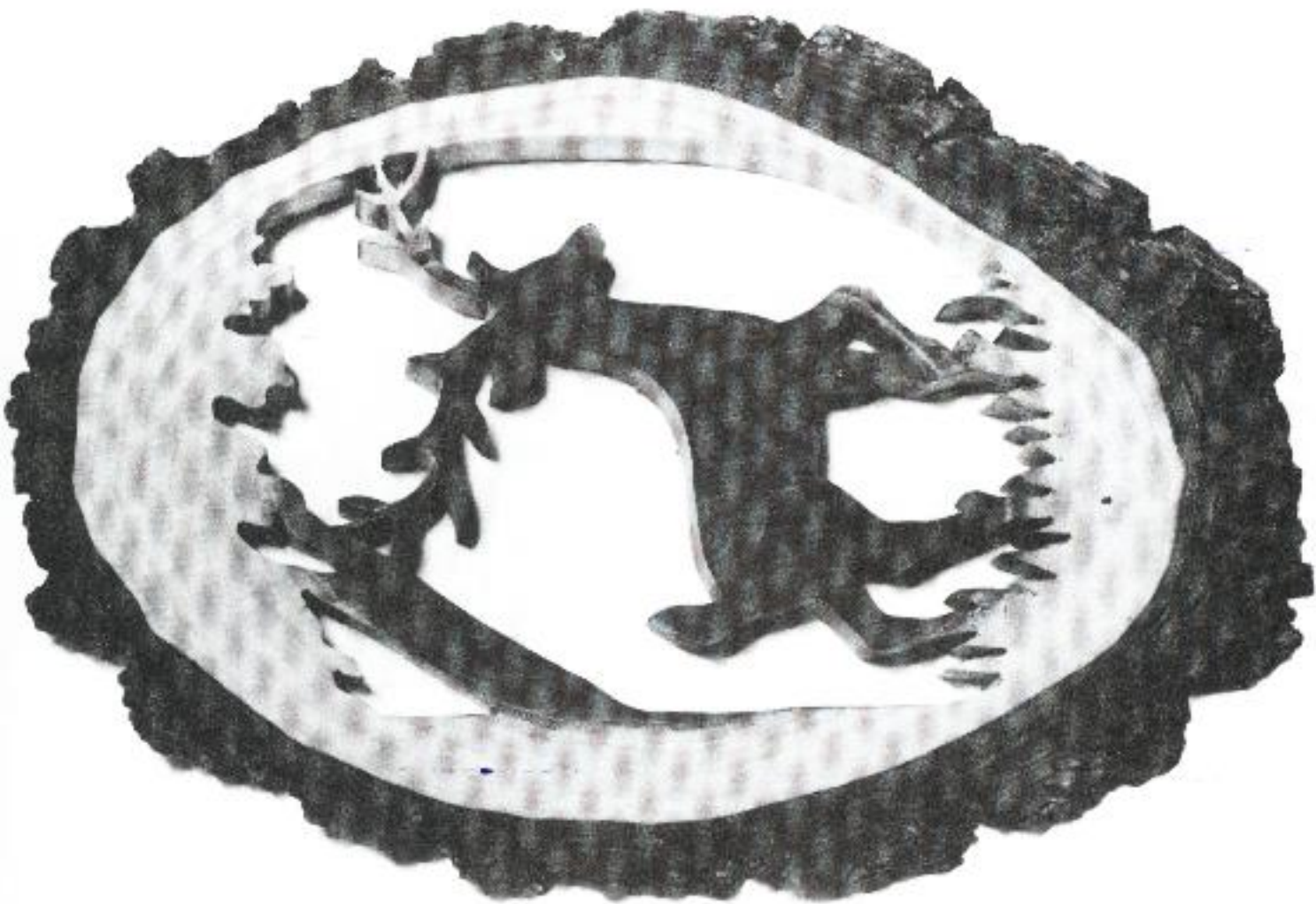

*Simple silhouette seen in a slab.*

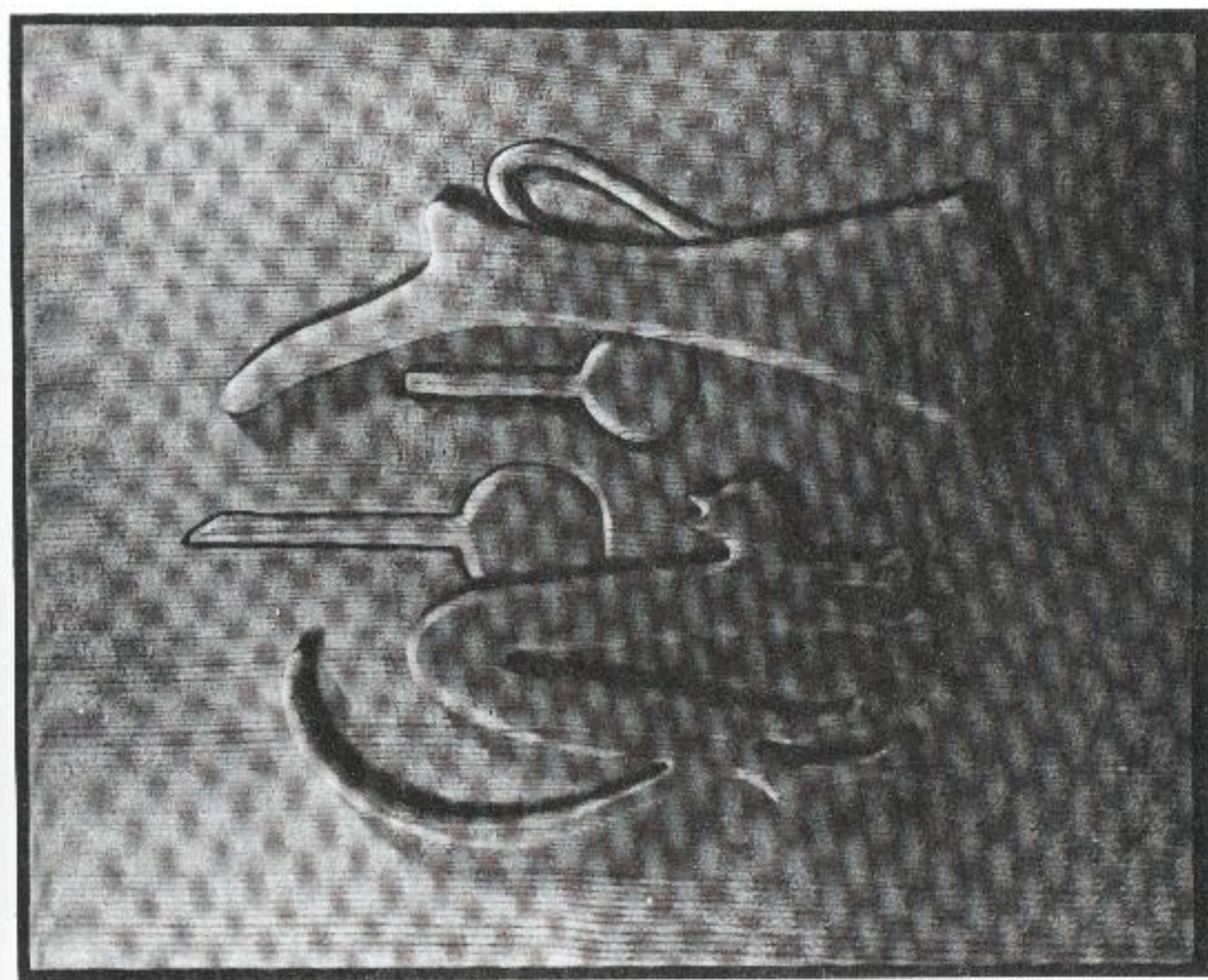

*Designs in relief. (See the Scroll Saw Handbook for a discussion of the technique.)*

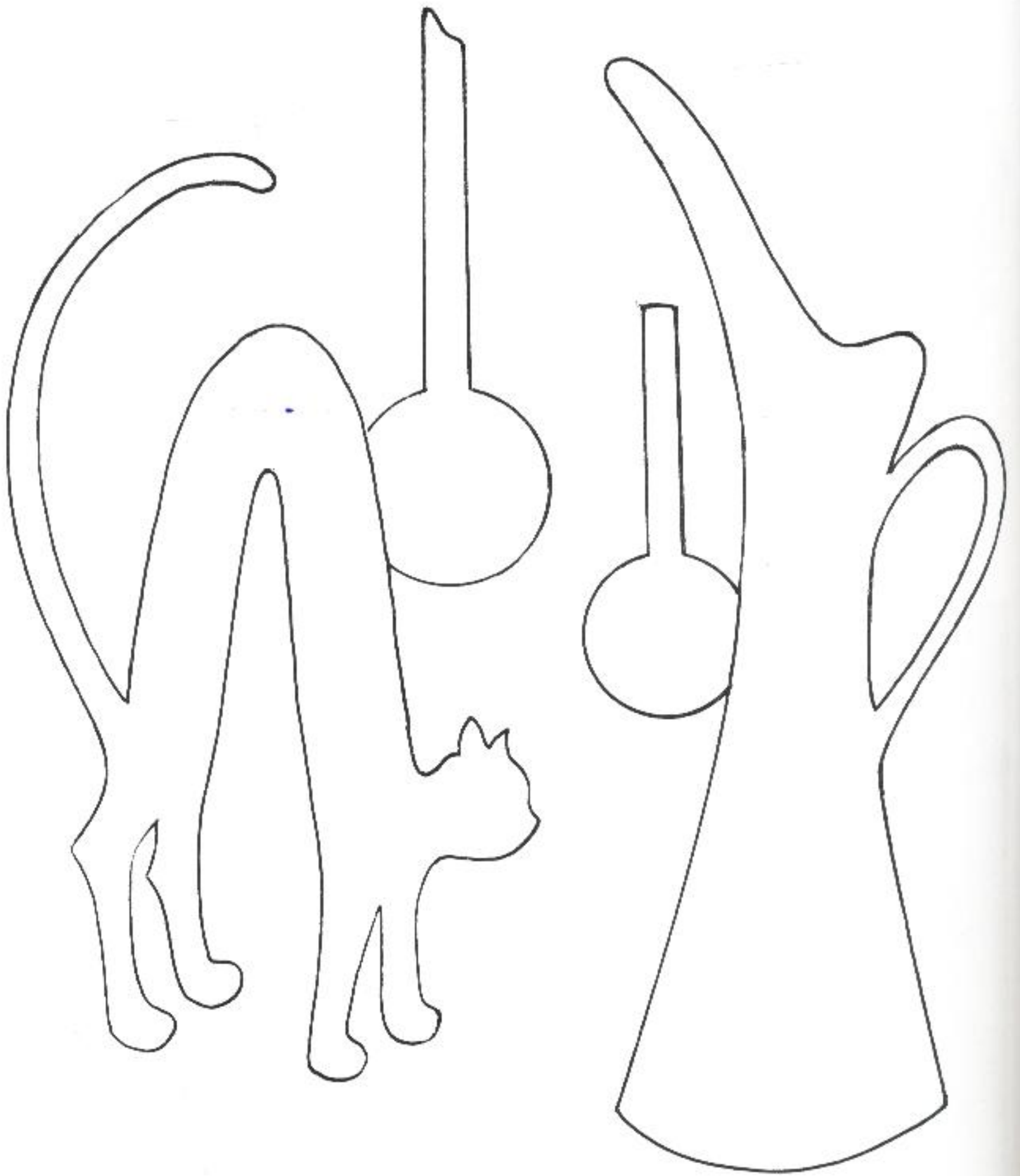



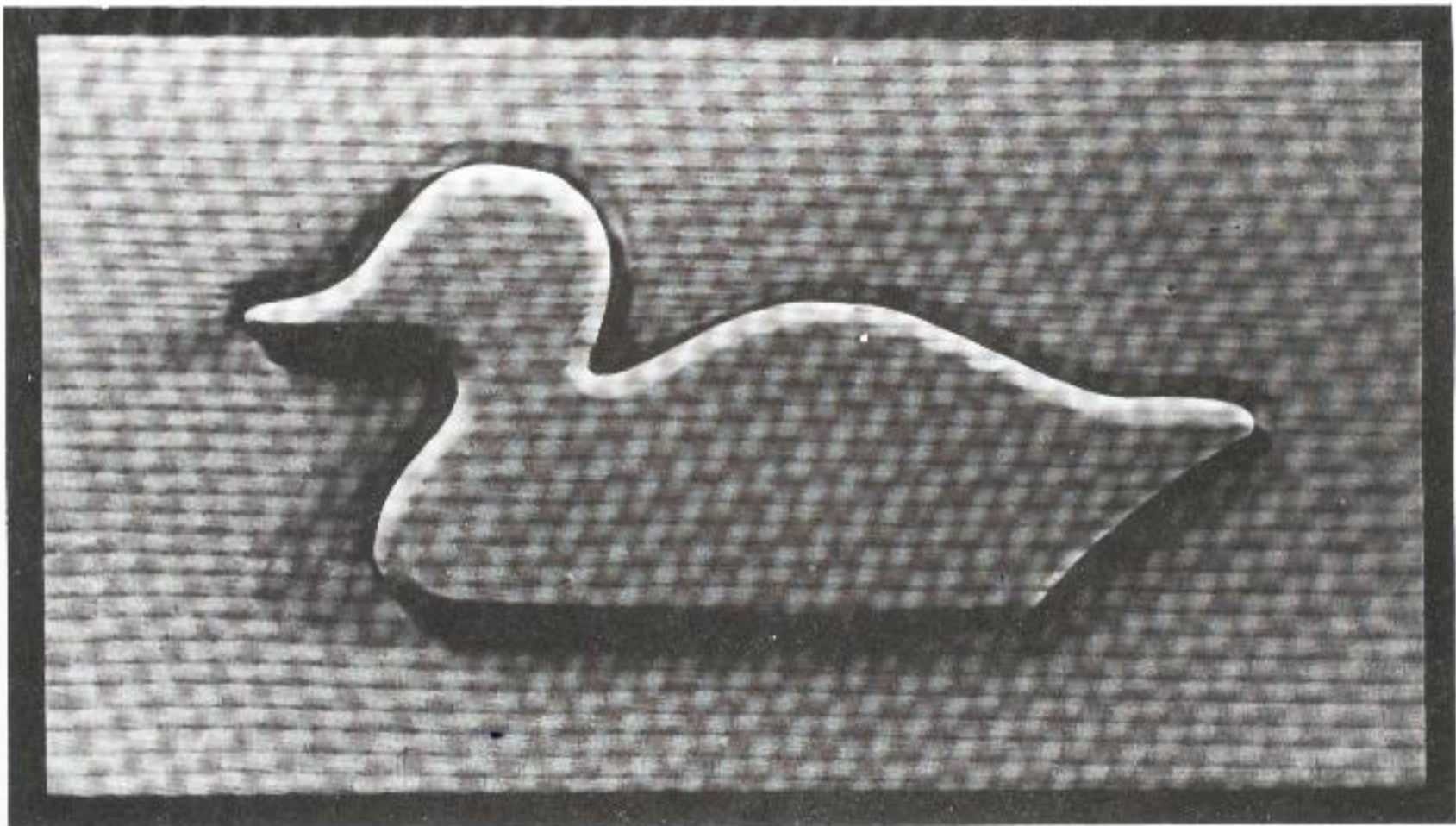

*Simple line work, cut, rounded, and reinserted.*

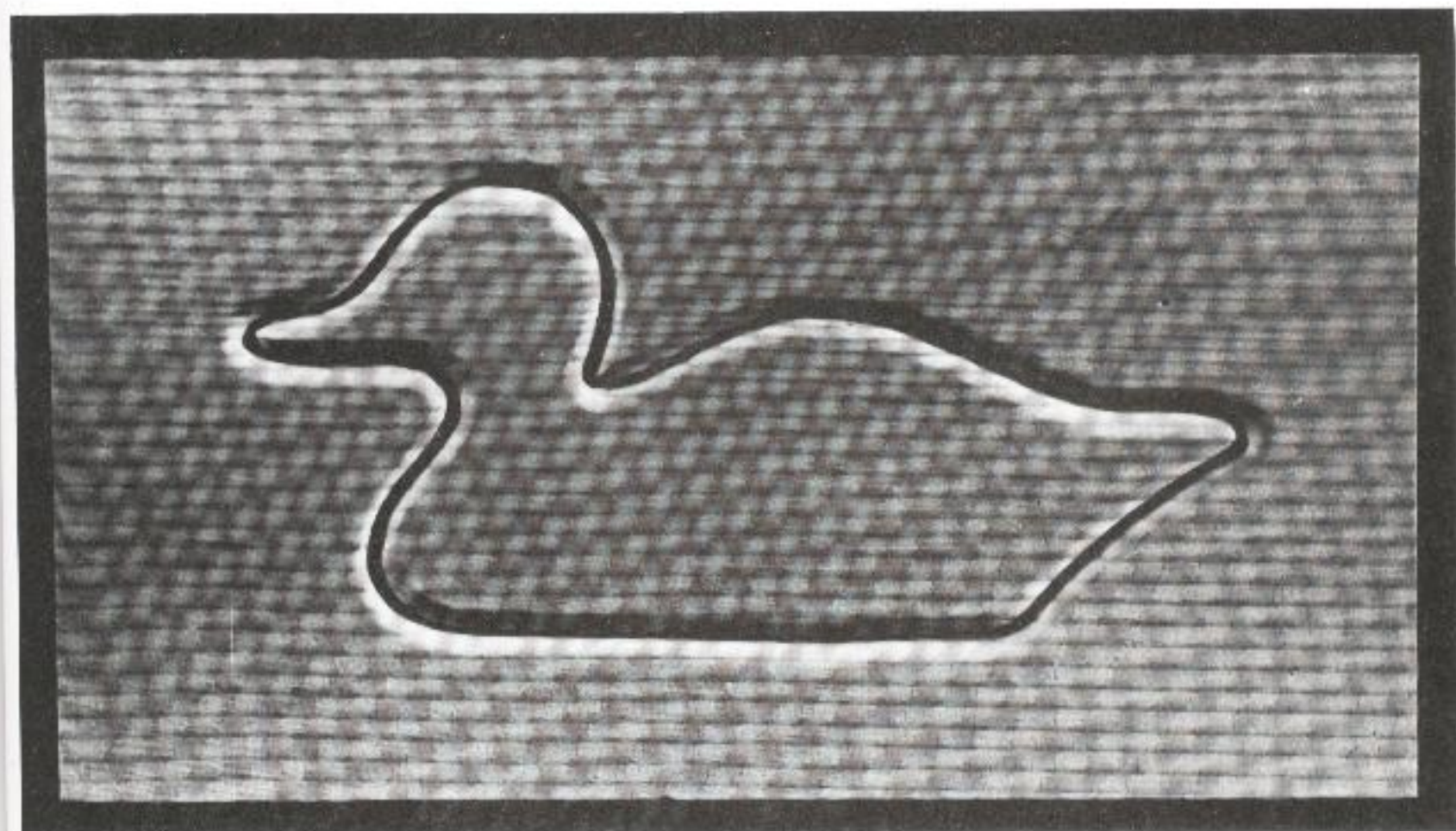

*The same idea, but inserted in relief. (See the Scroll Saw Handbook for more information.)*



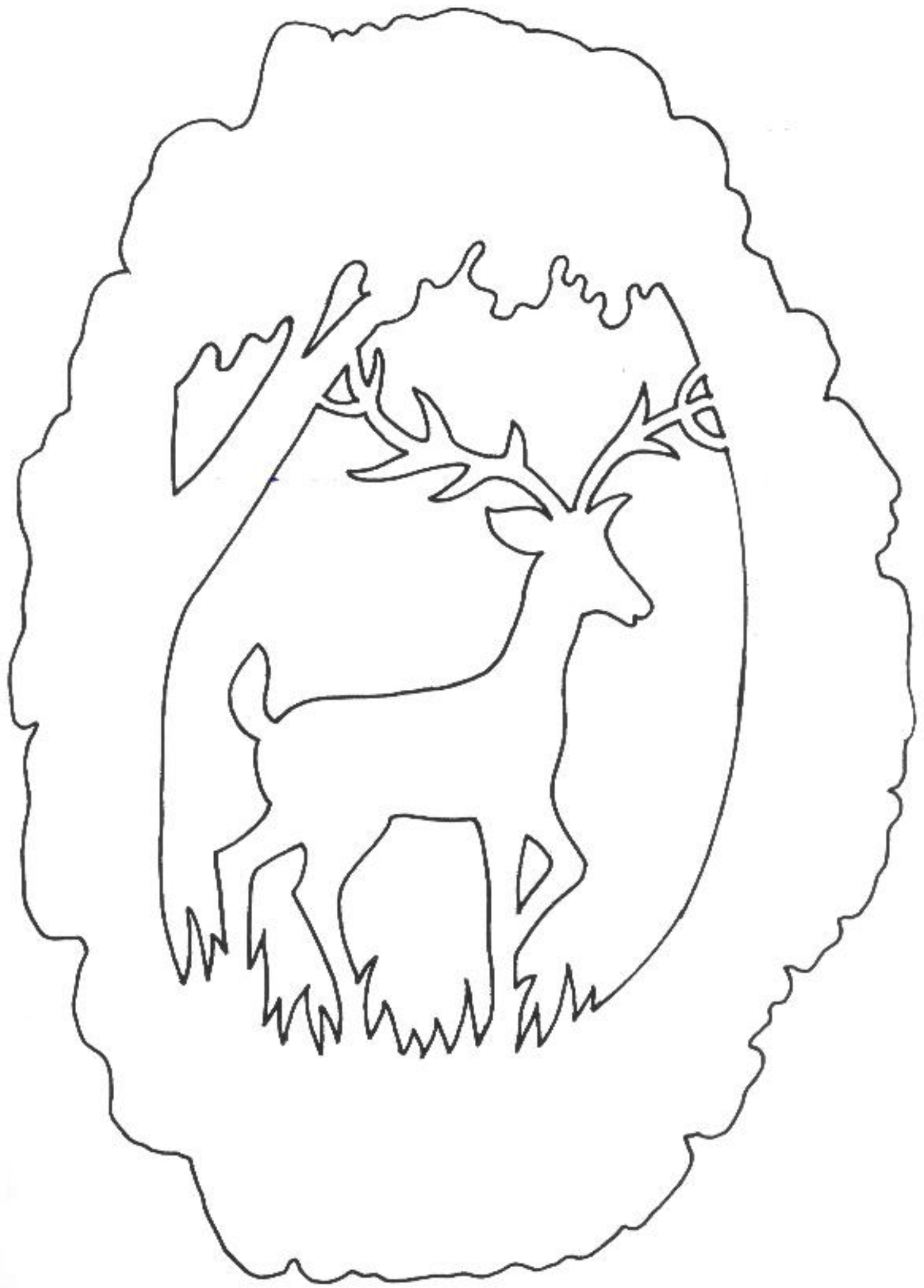

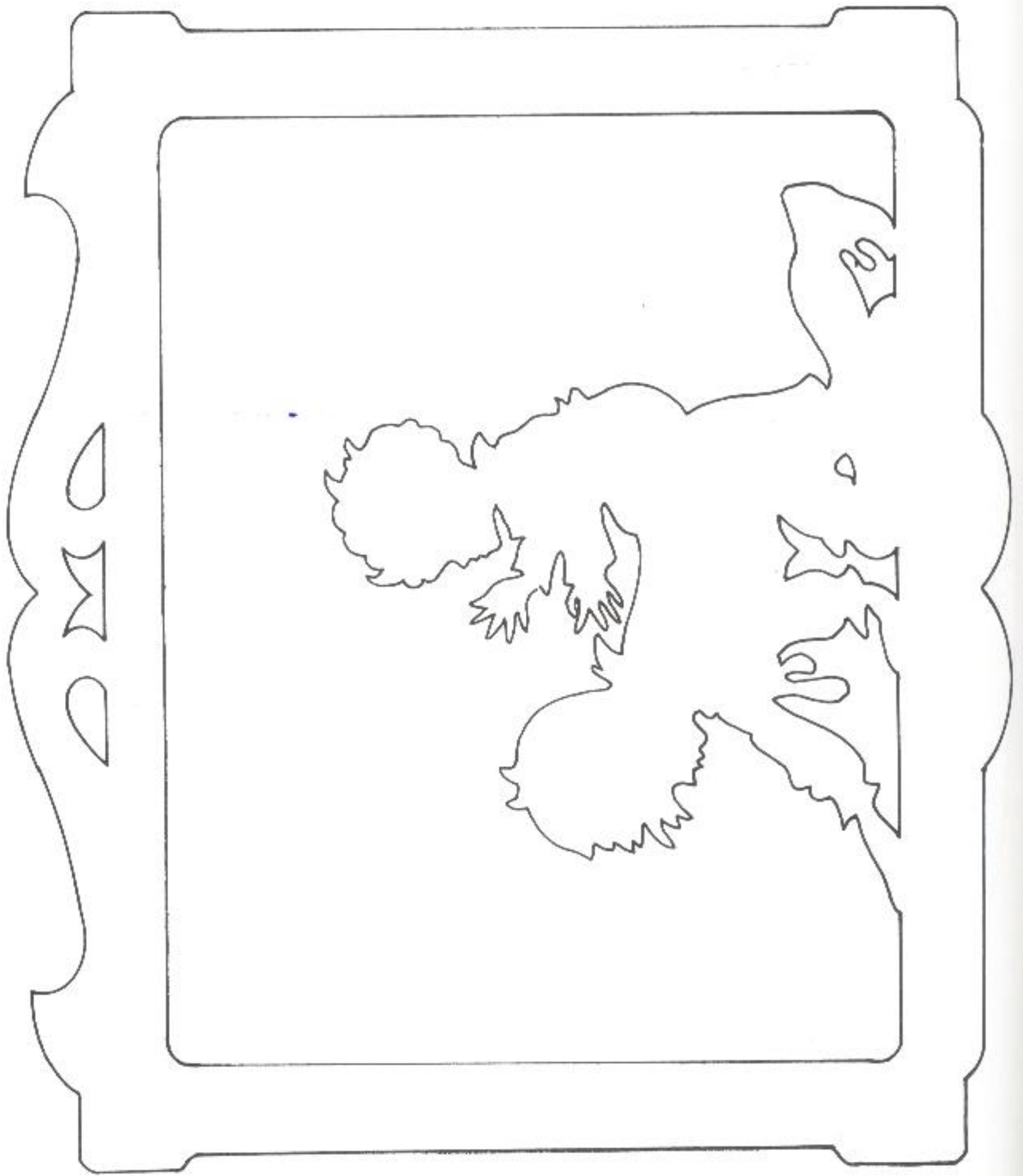

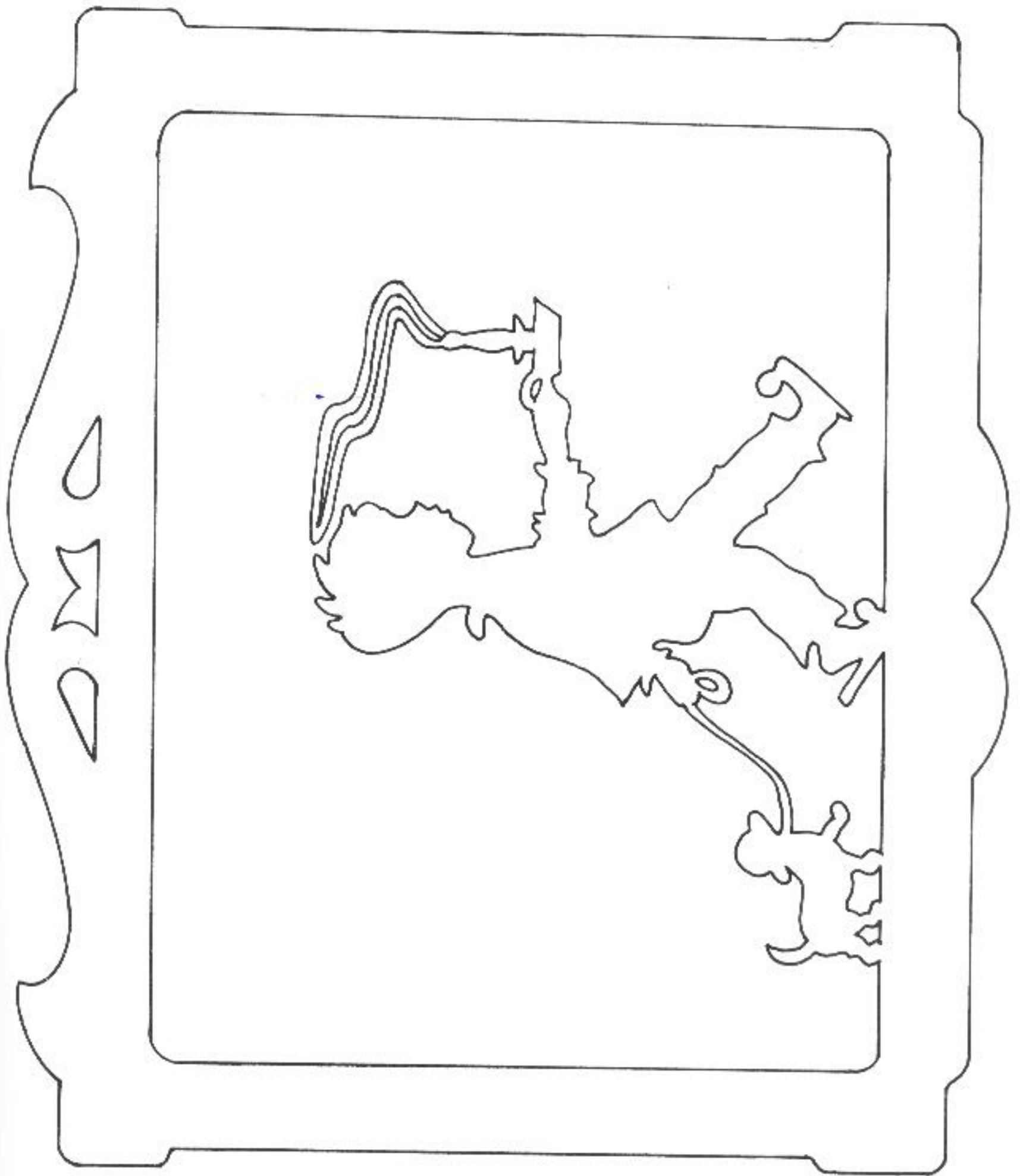

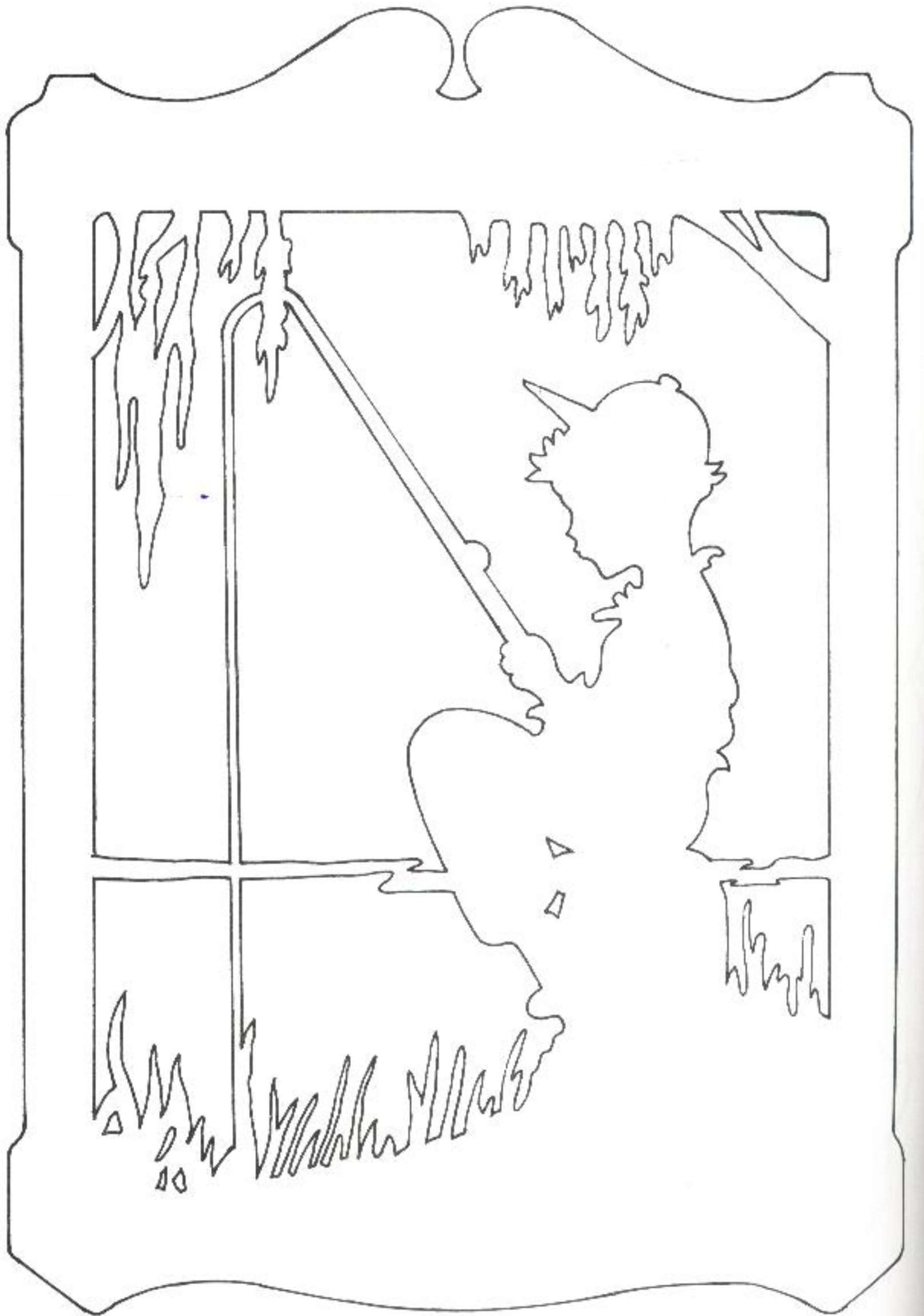

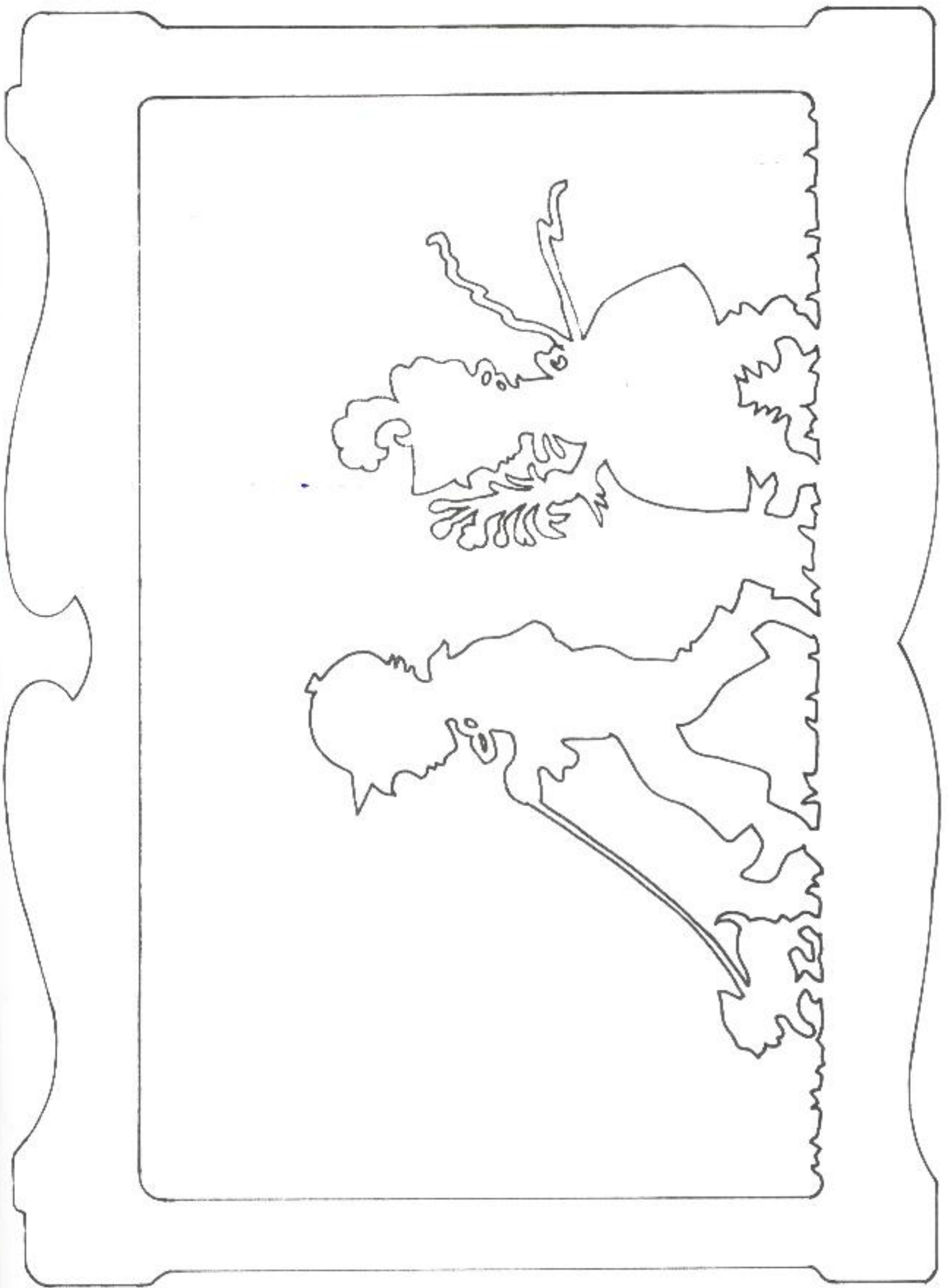

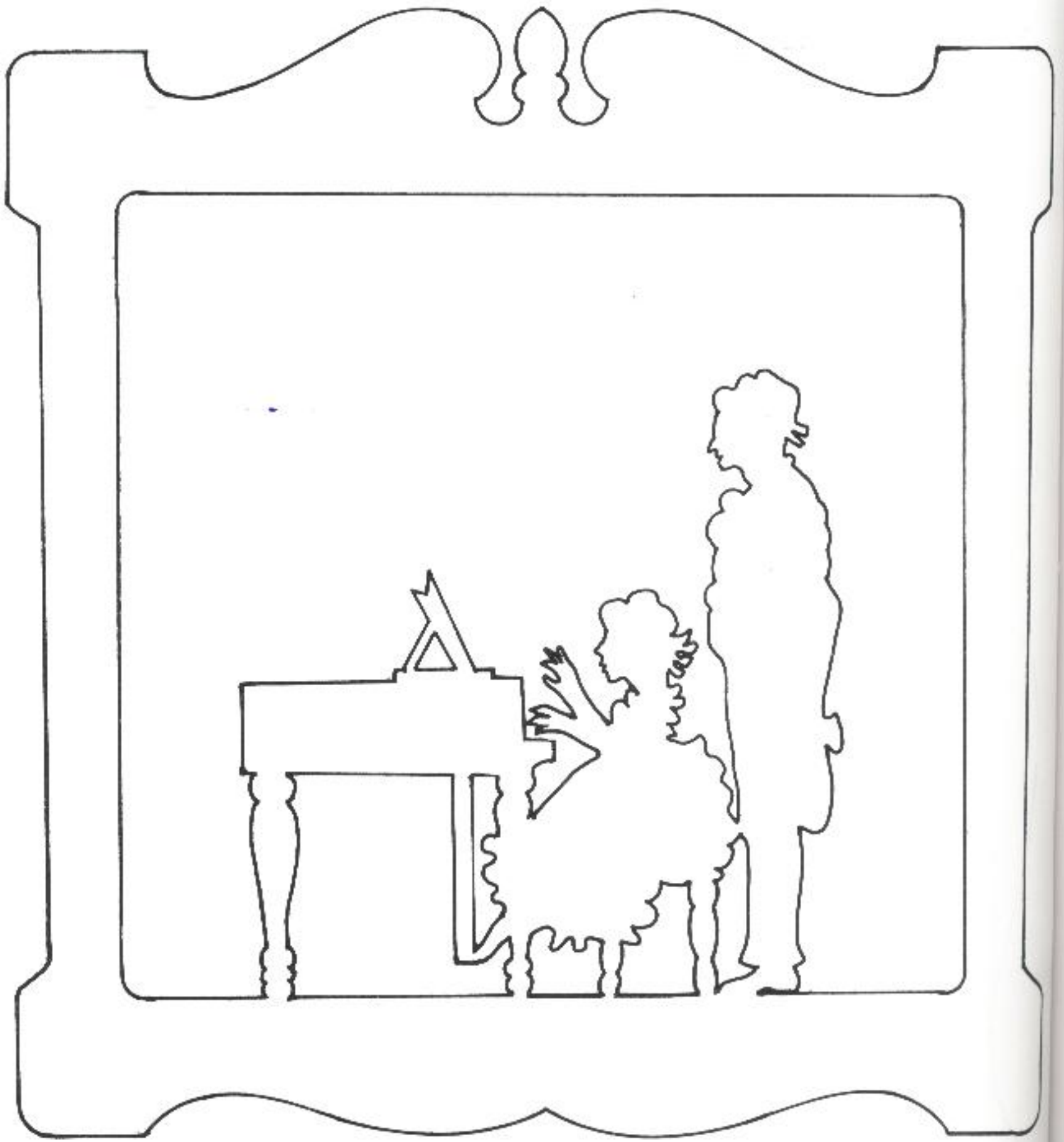



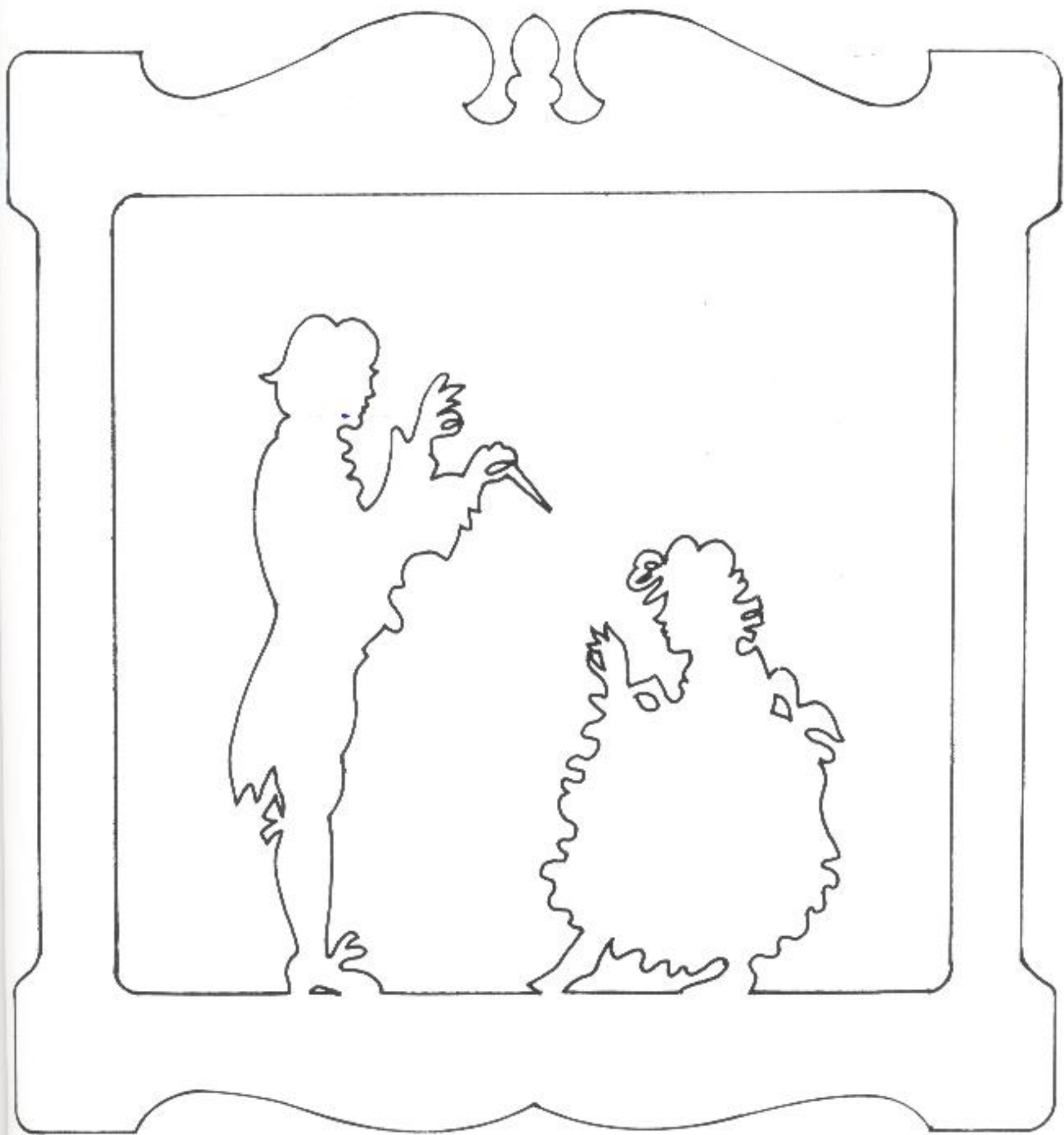

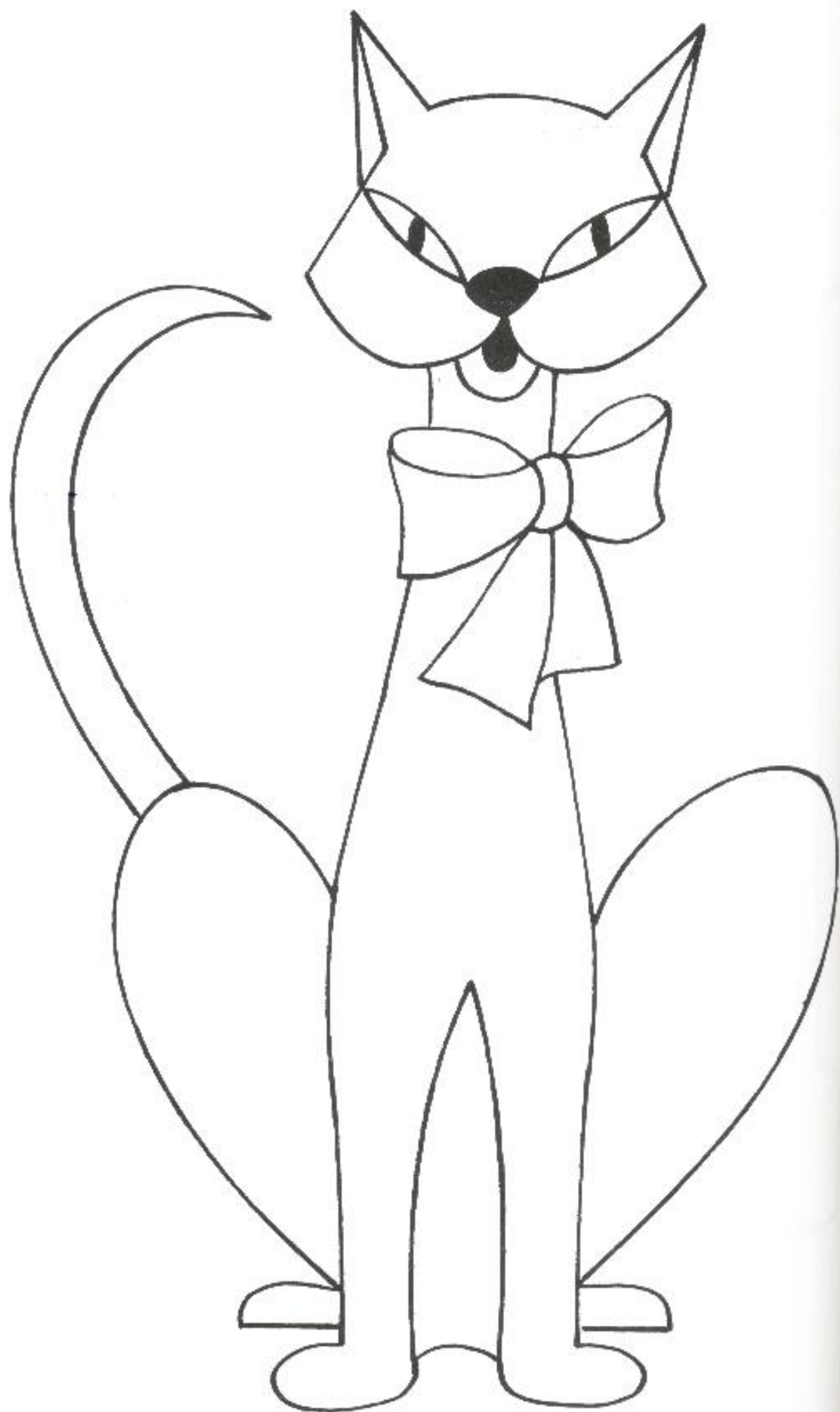

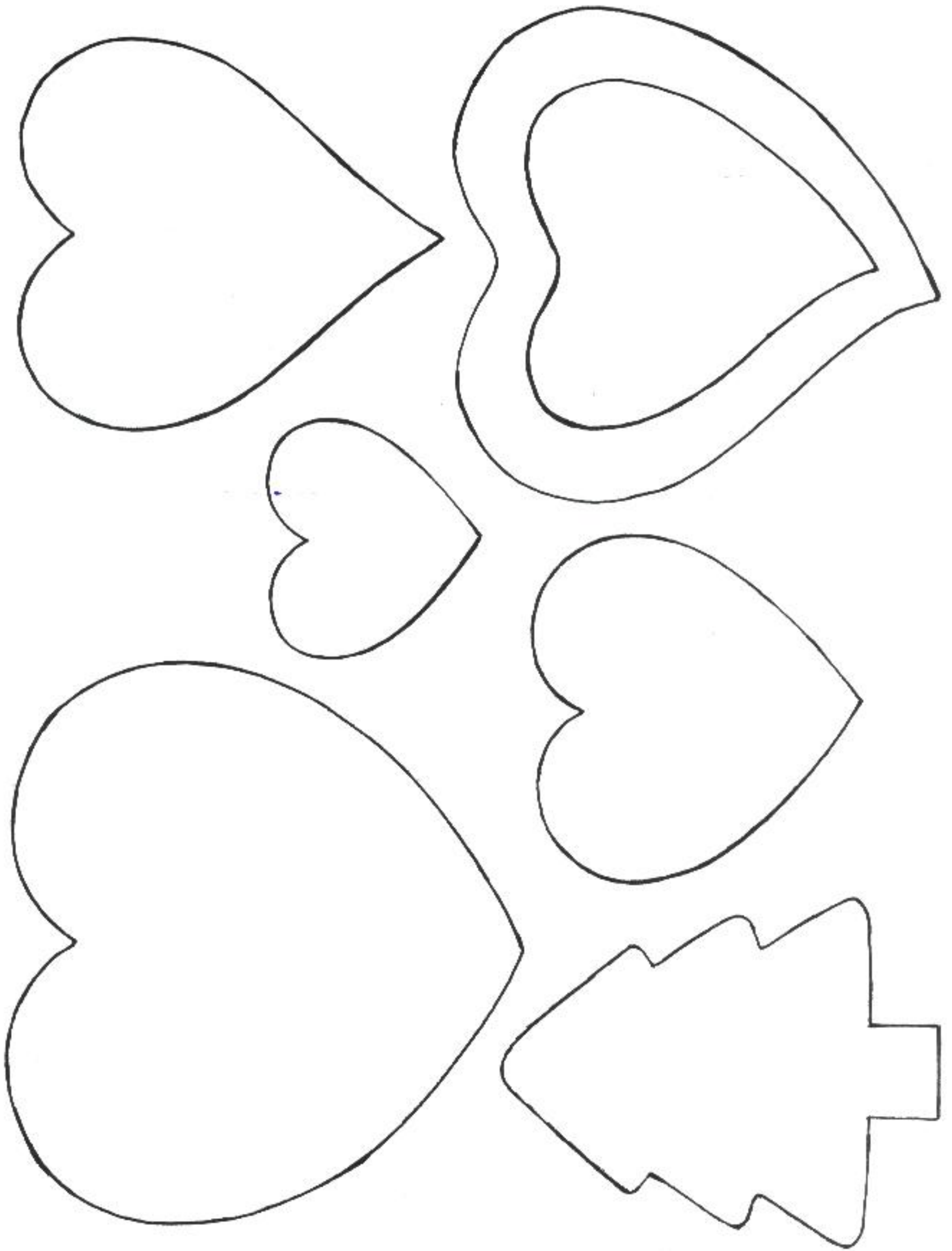

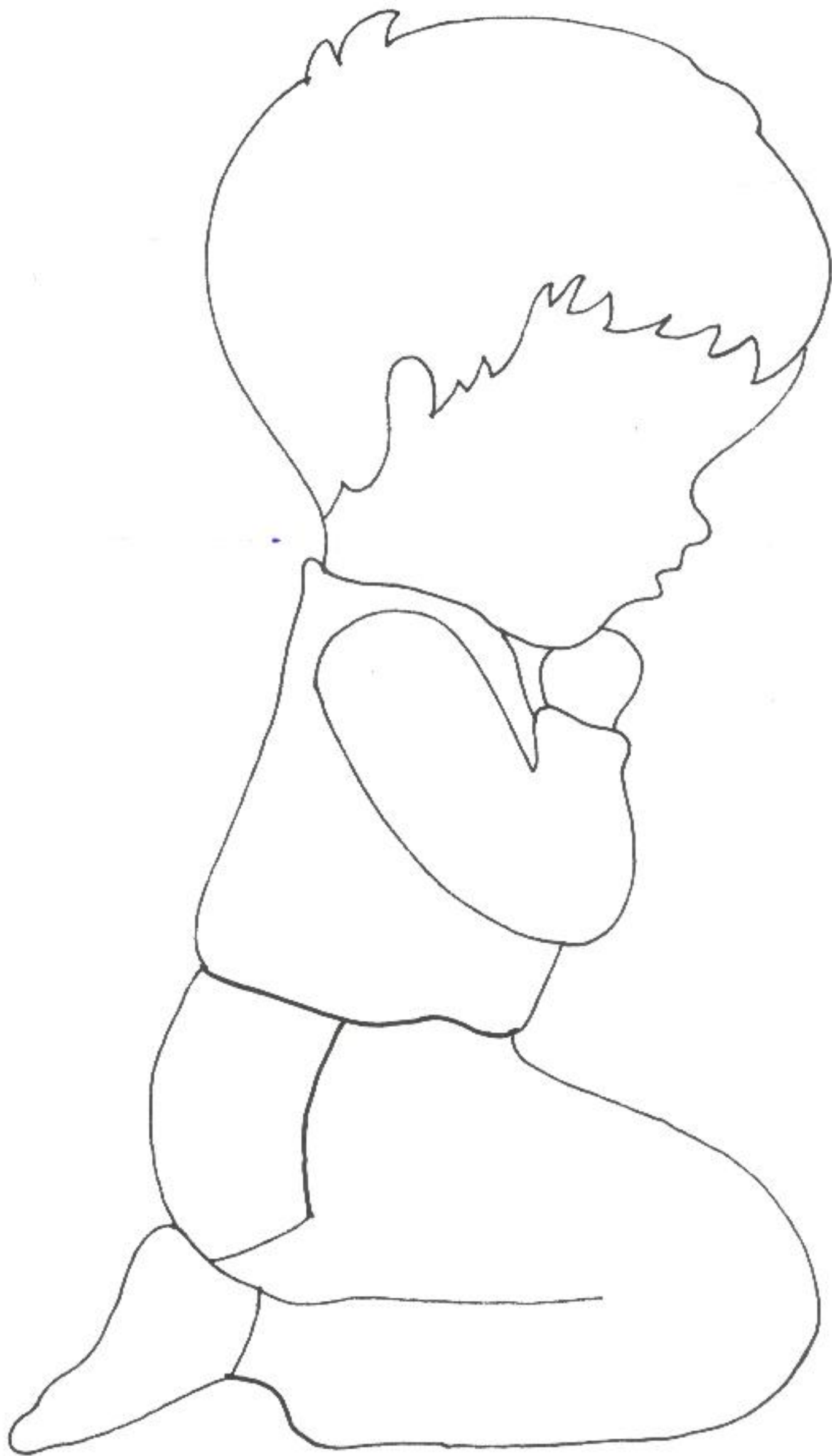





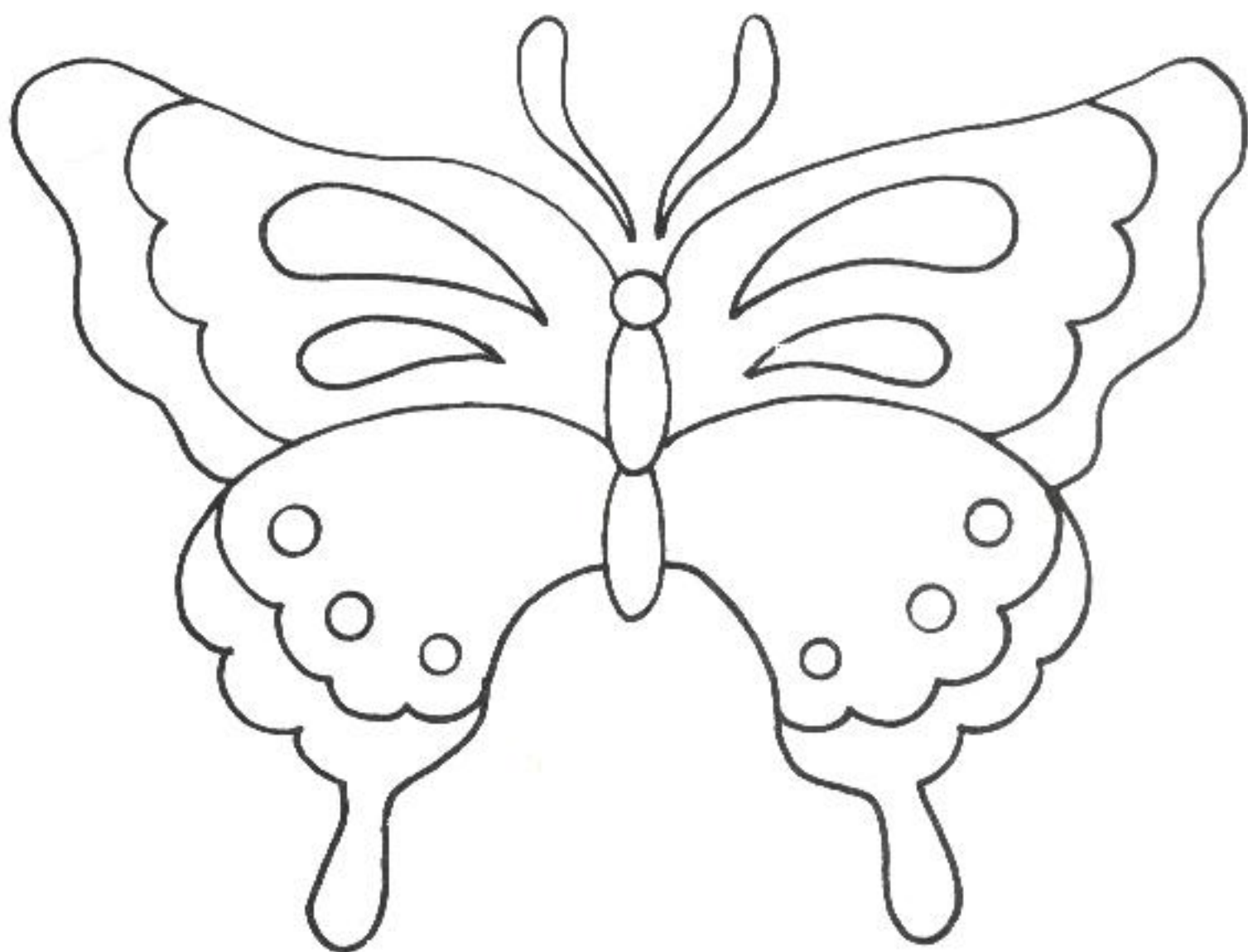
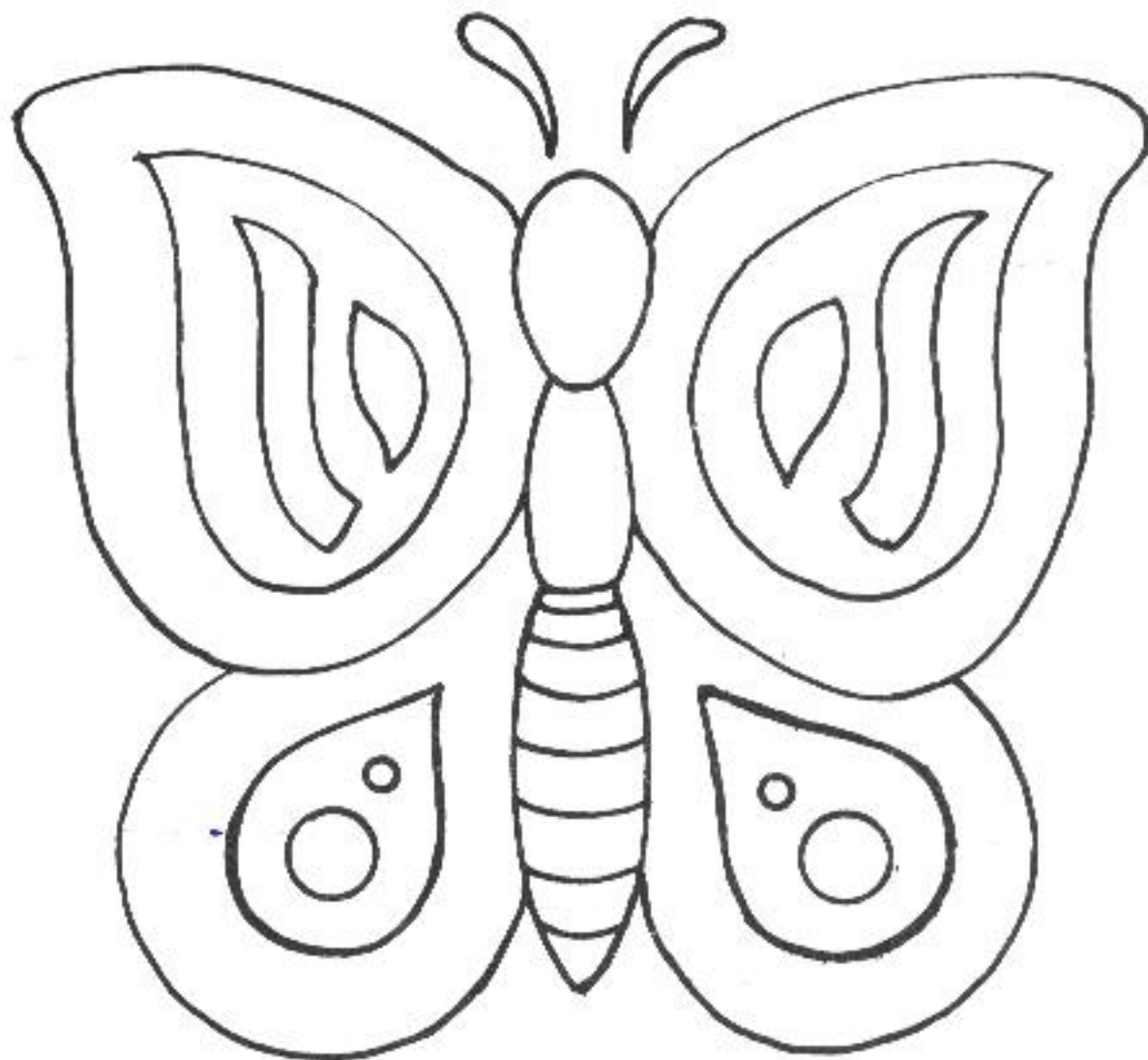





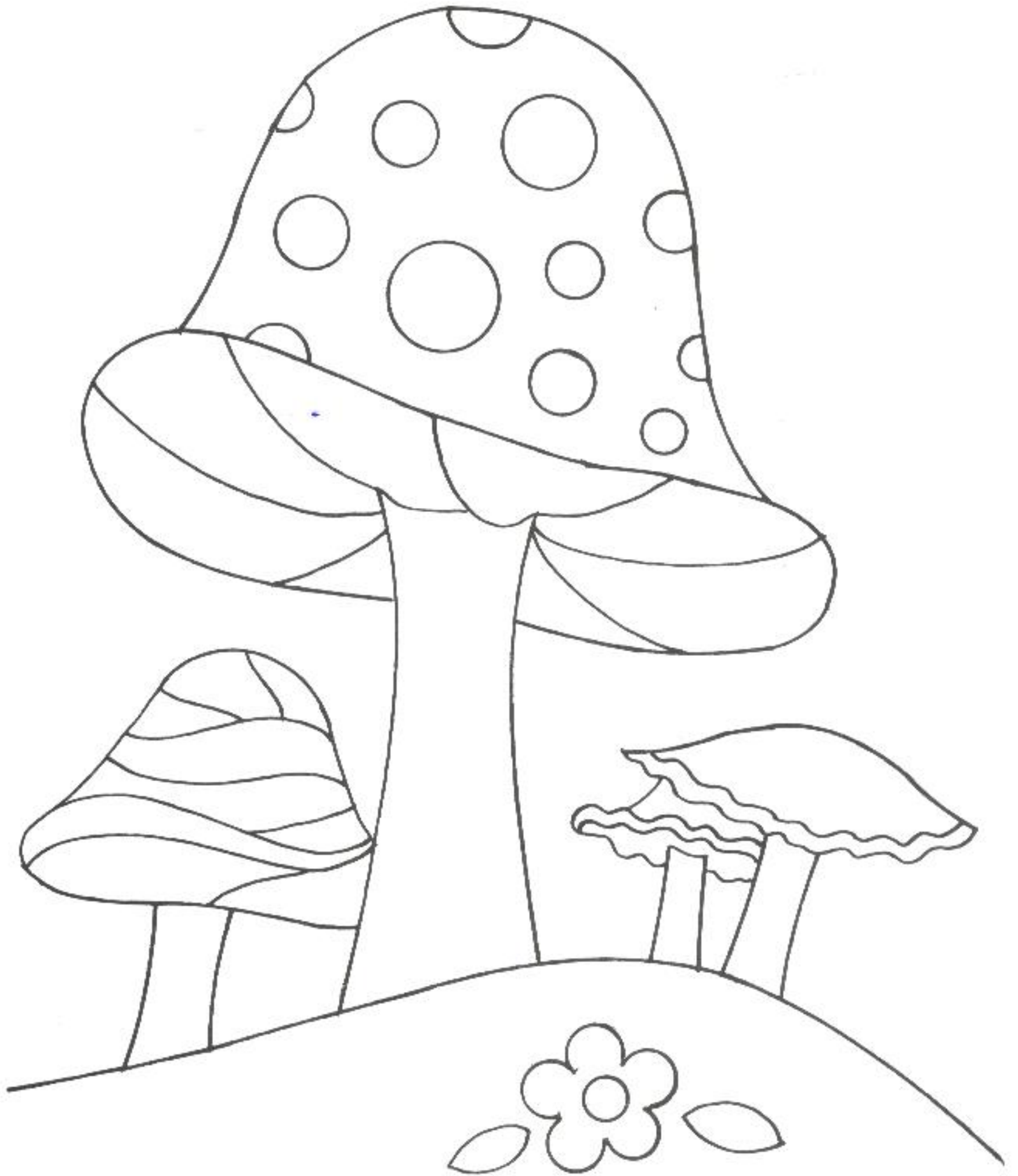

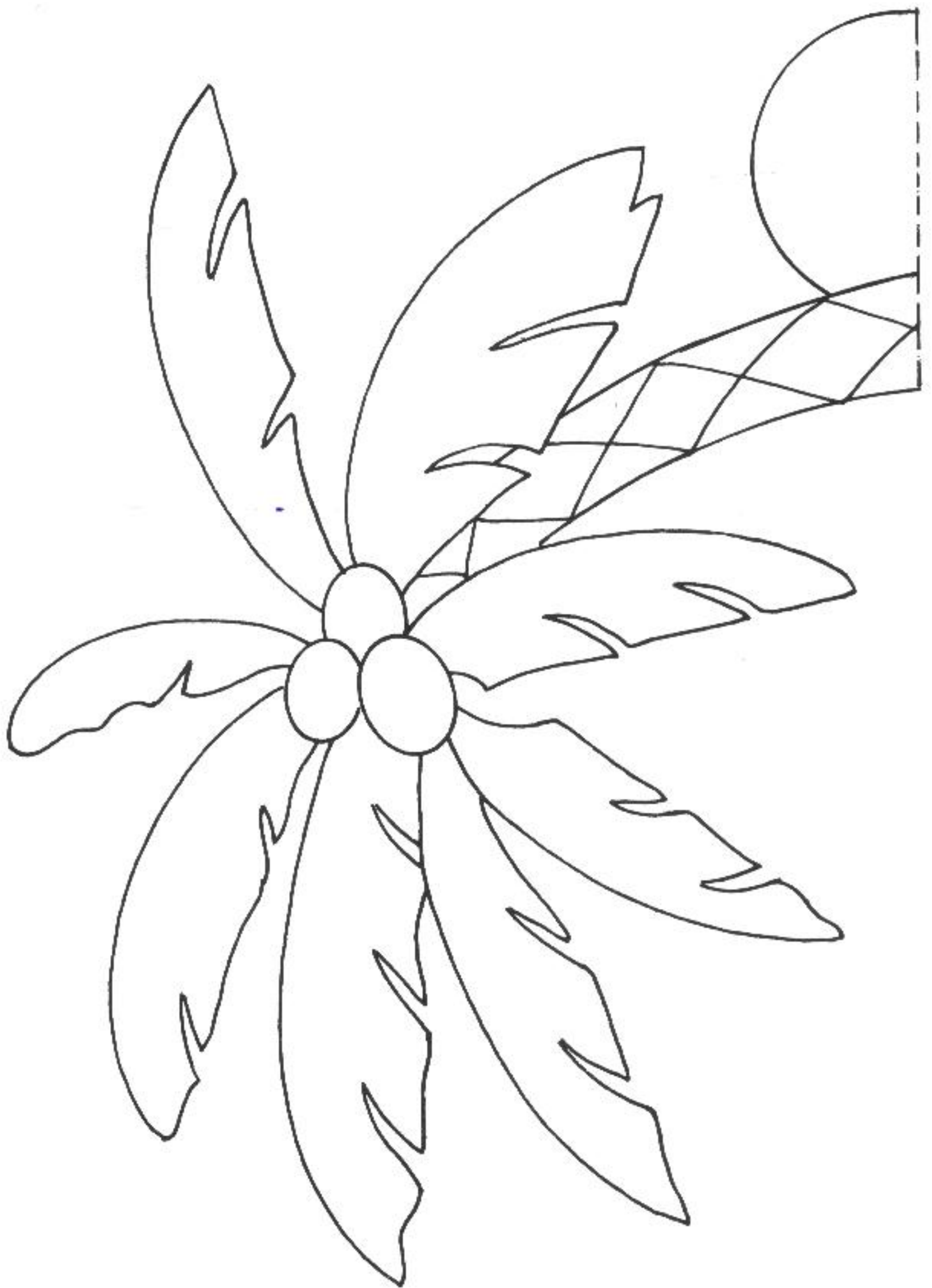

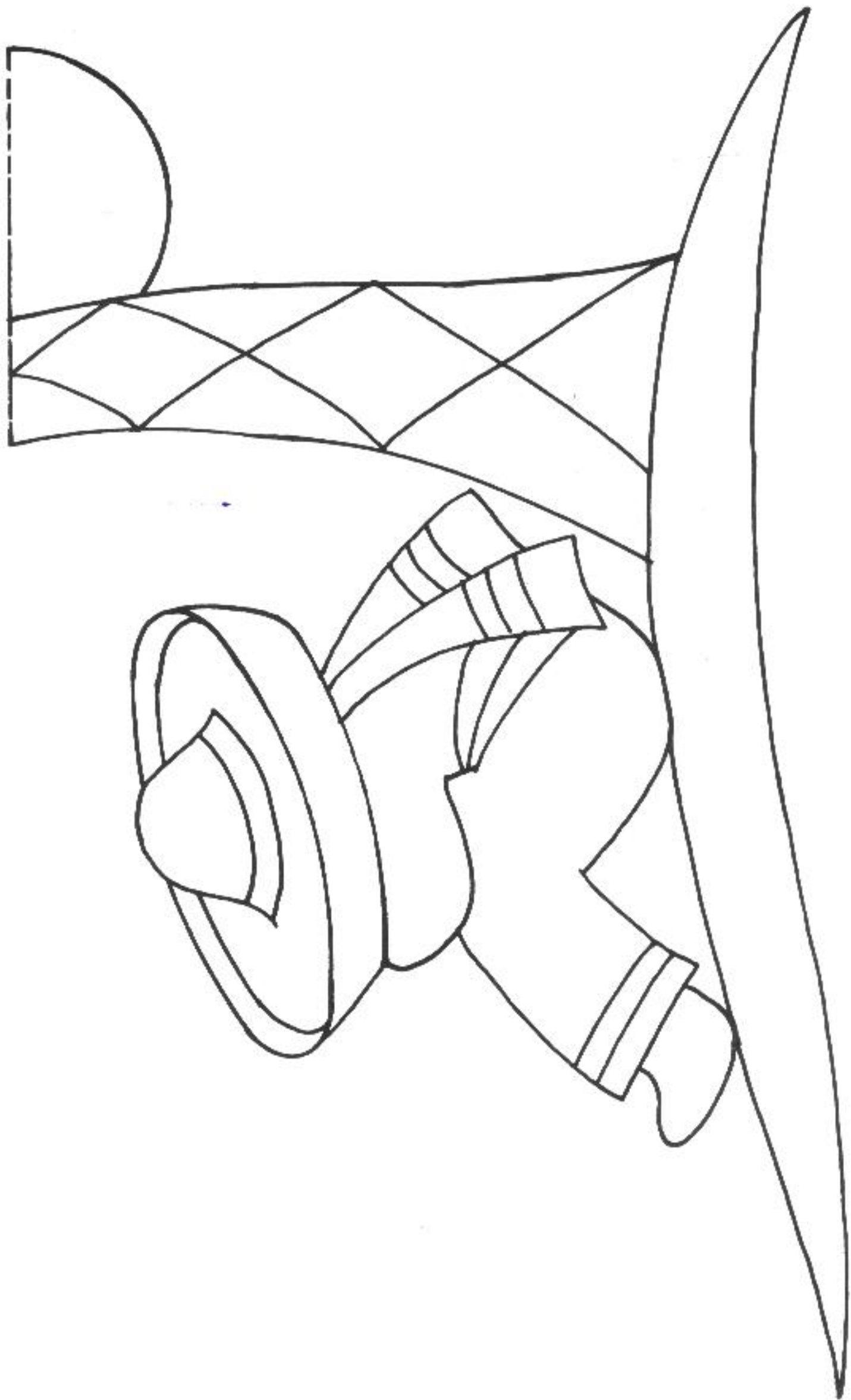

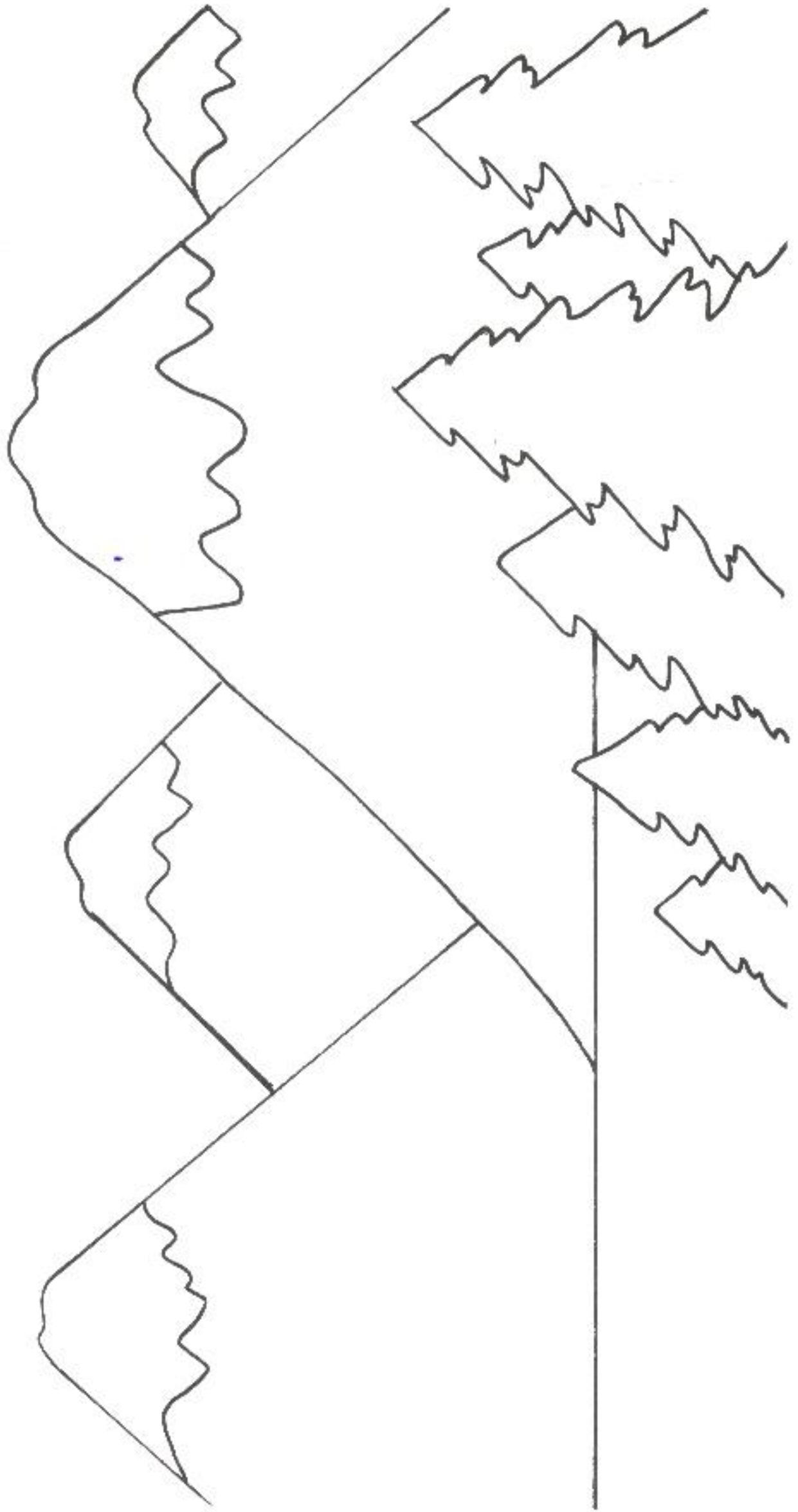
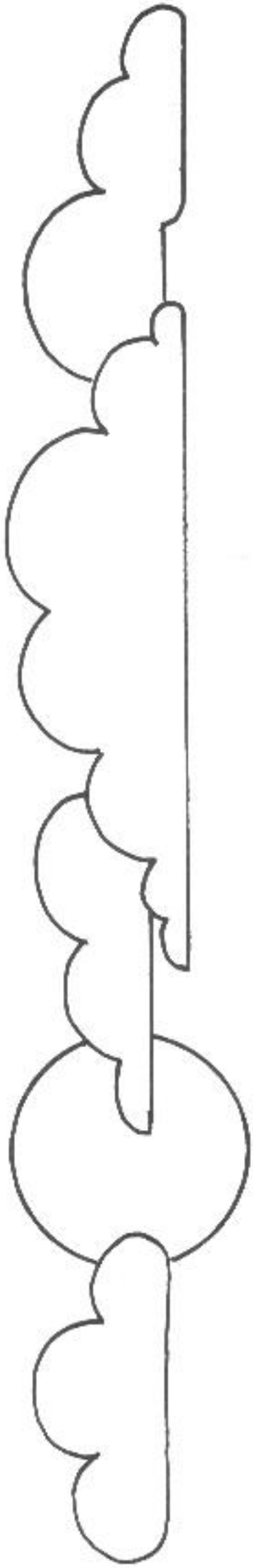

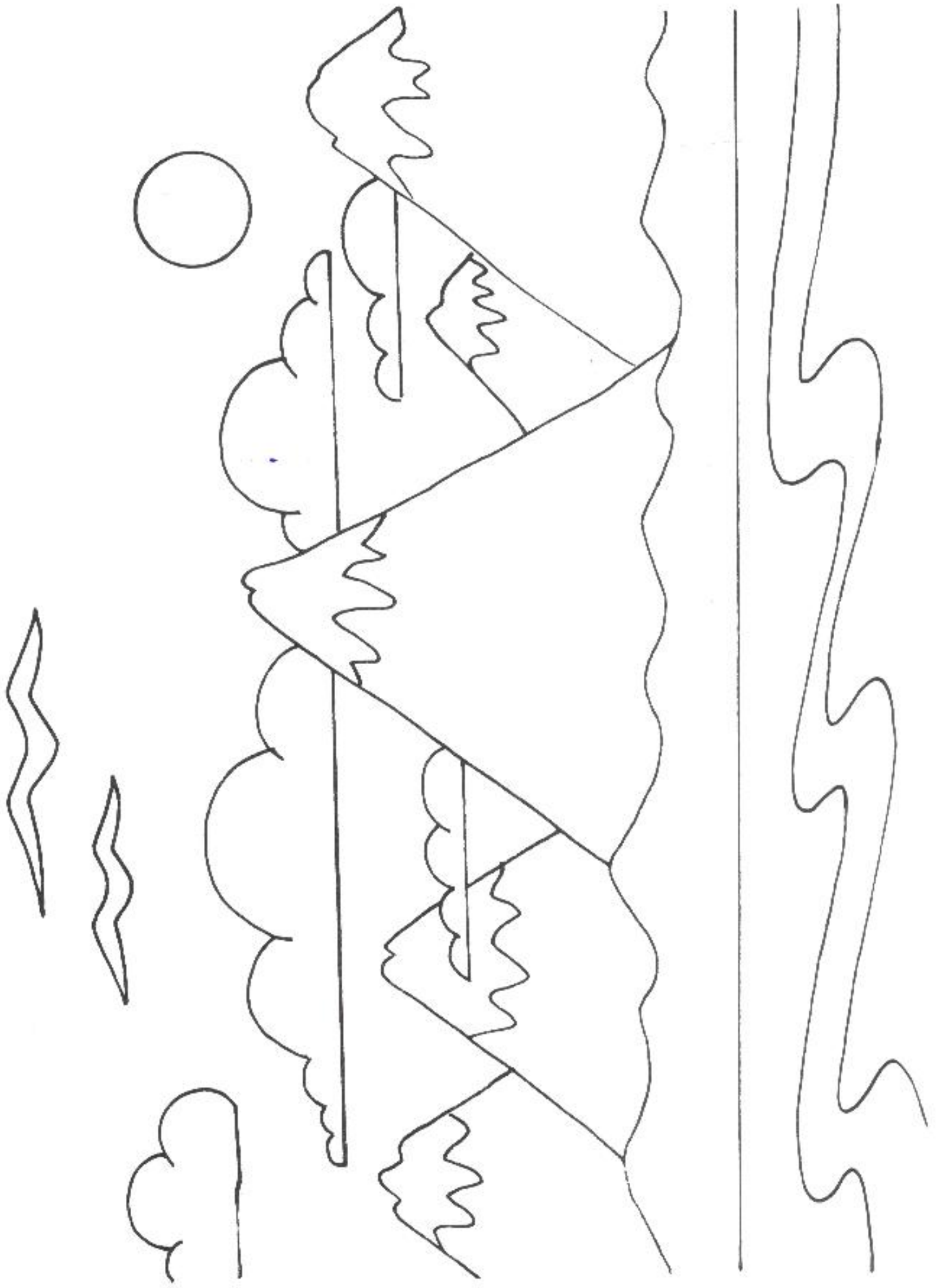





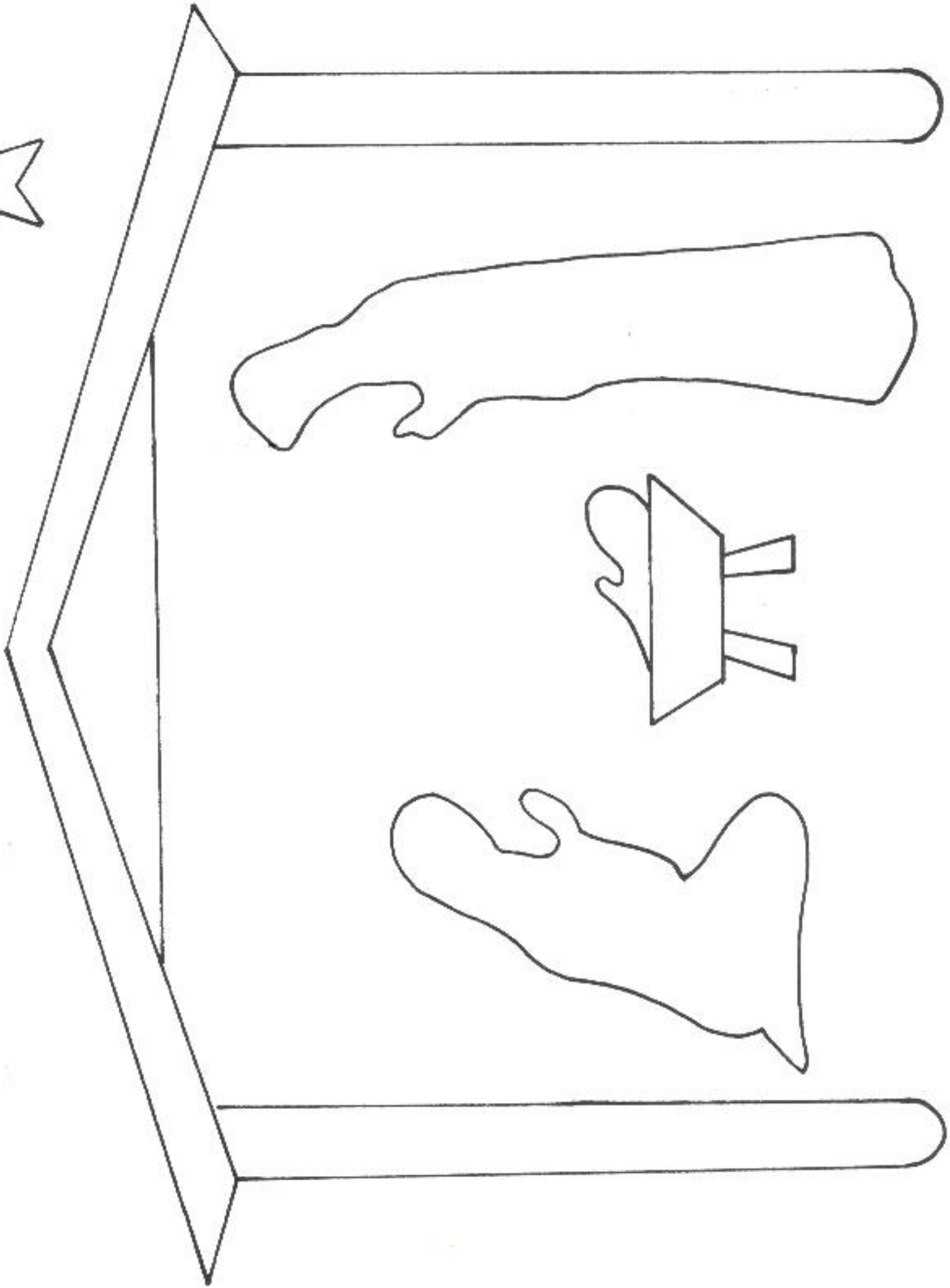



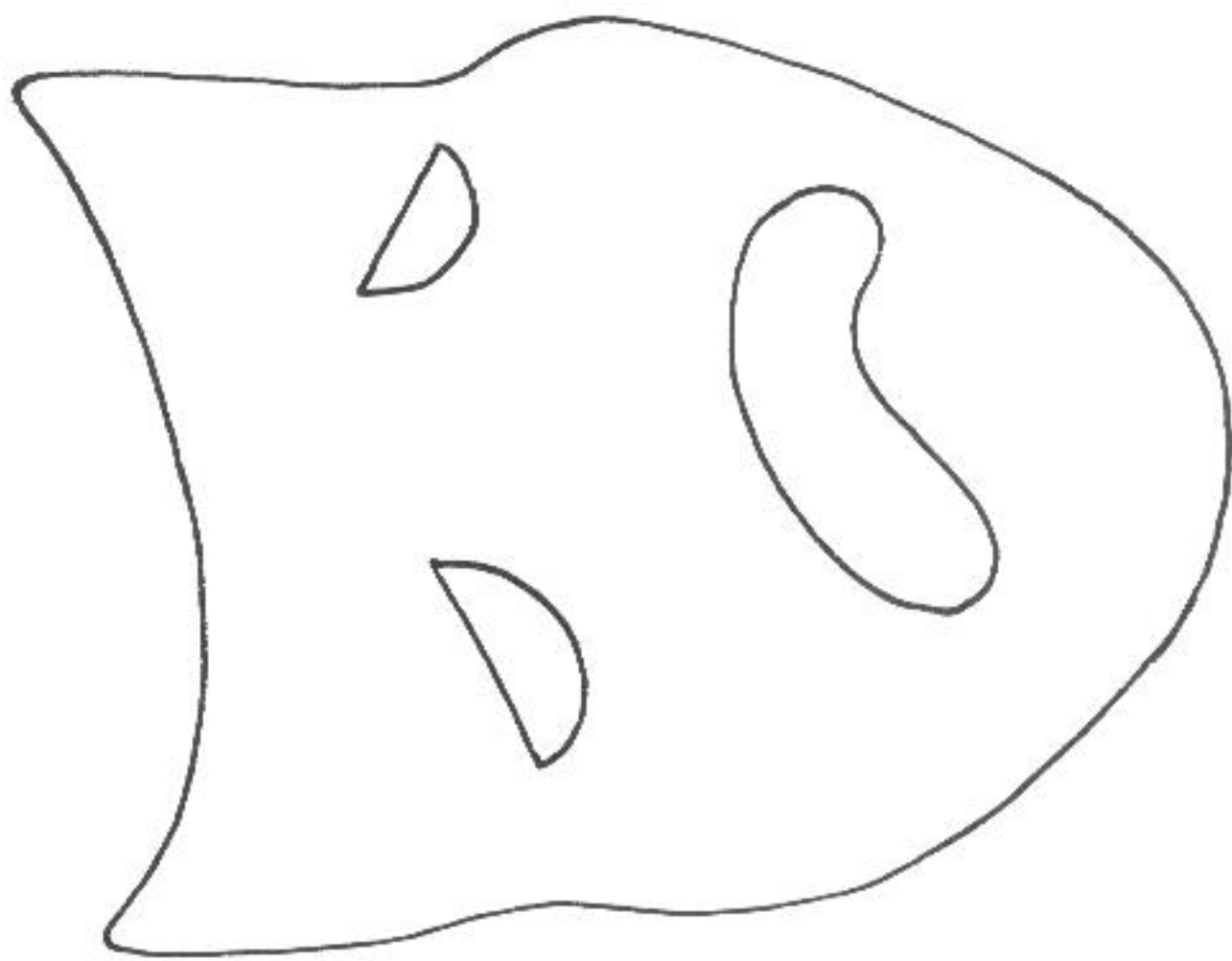
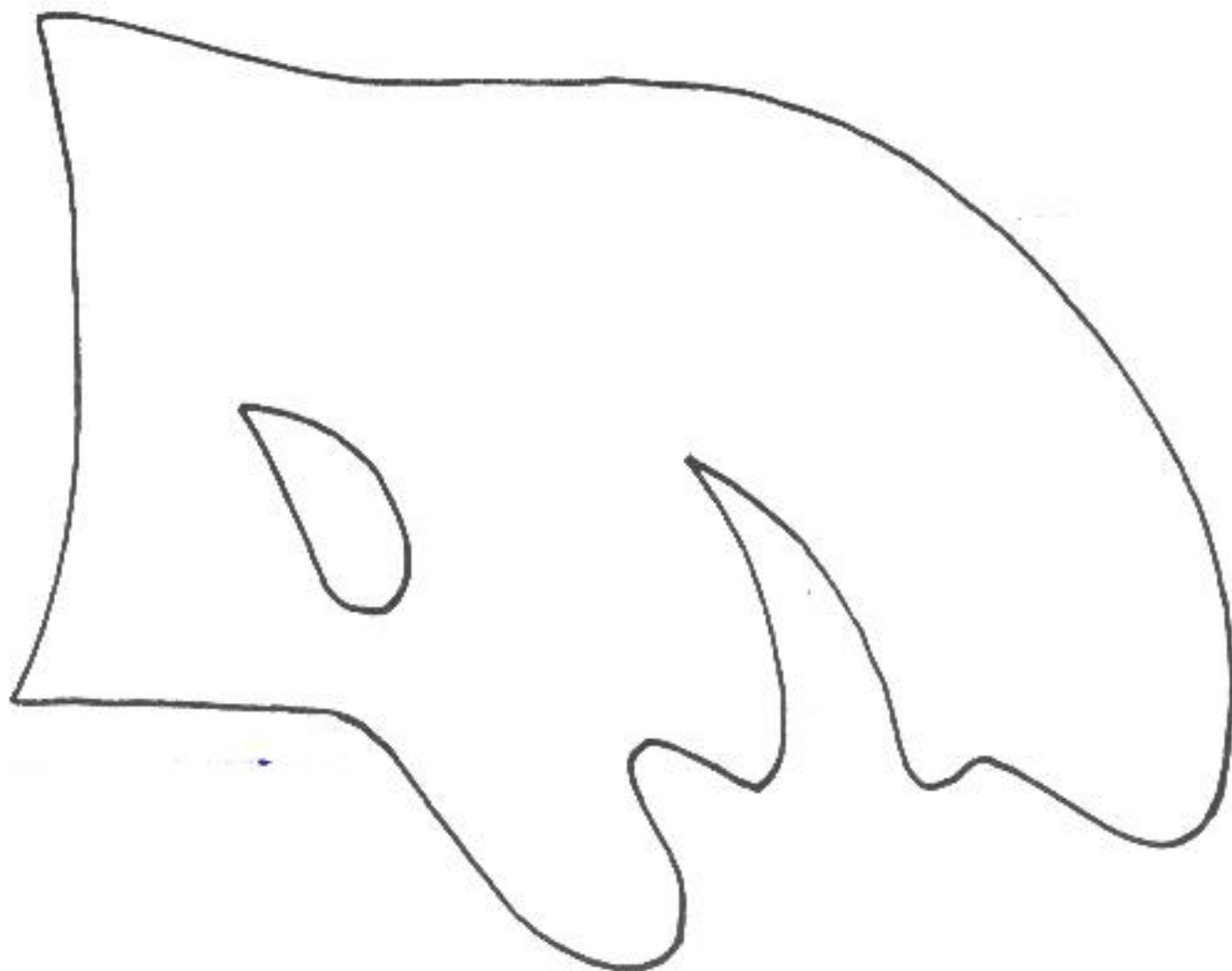

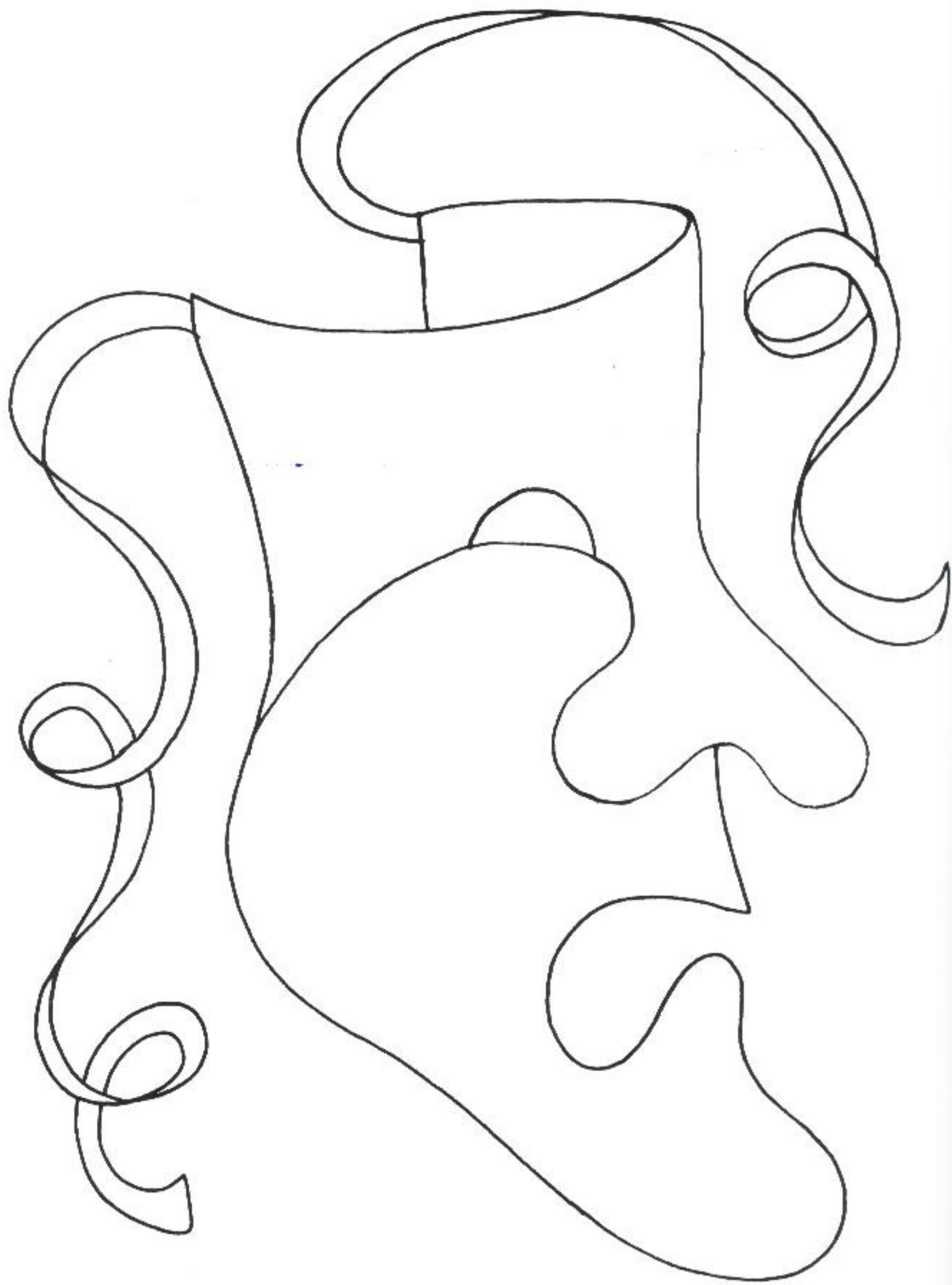



# Lamp Assembly

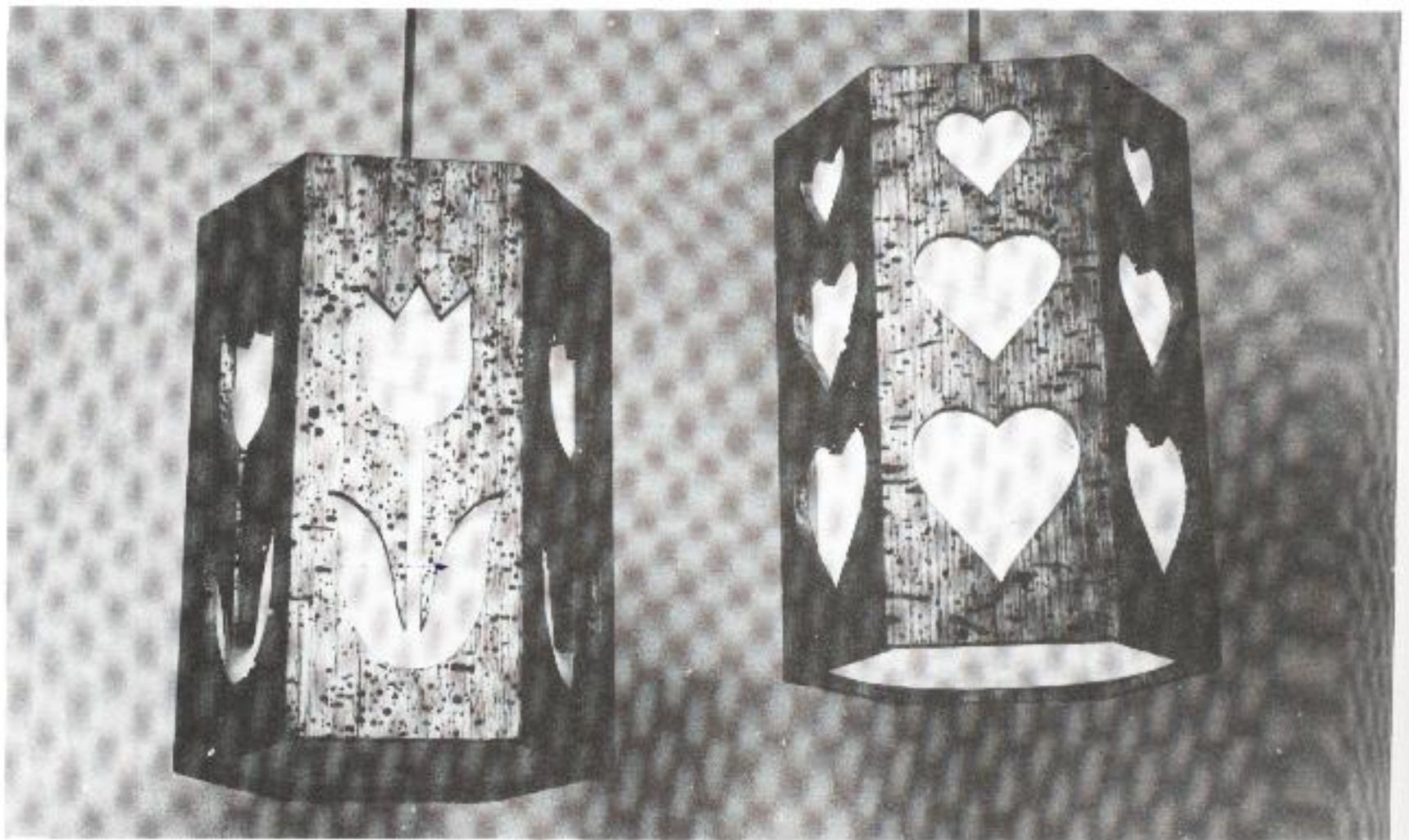

*Hanging hex lamps (above and below).*

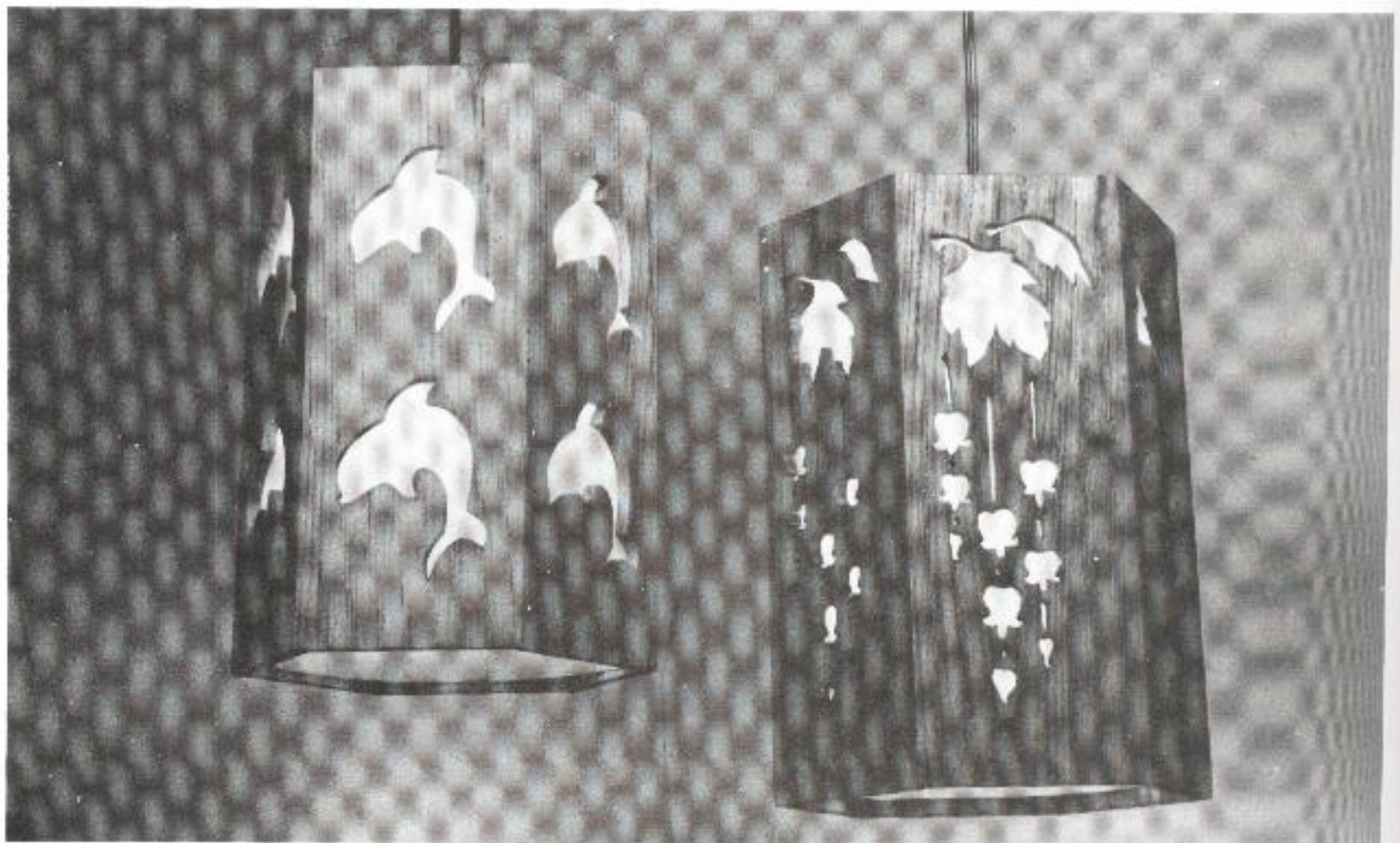

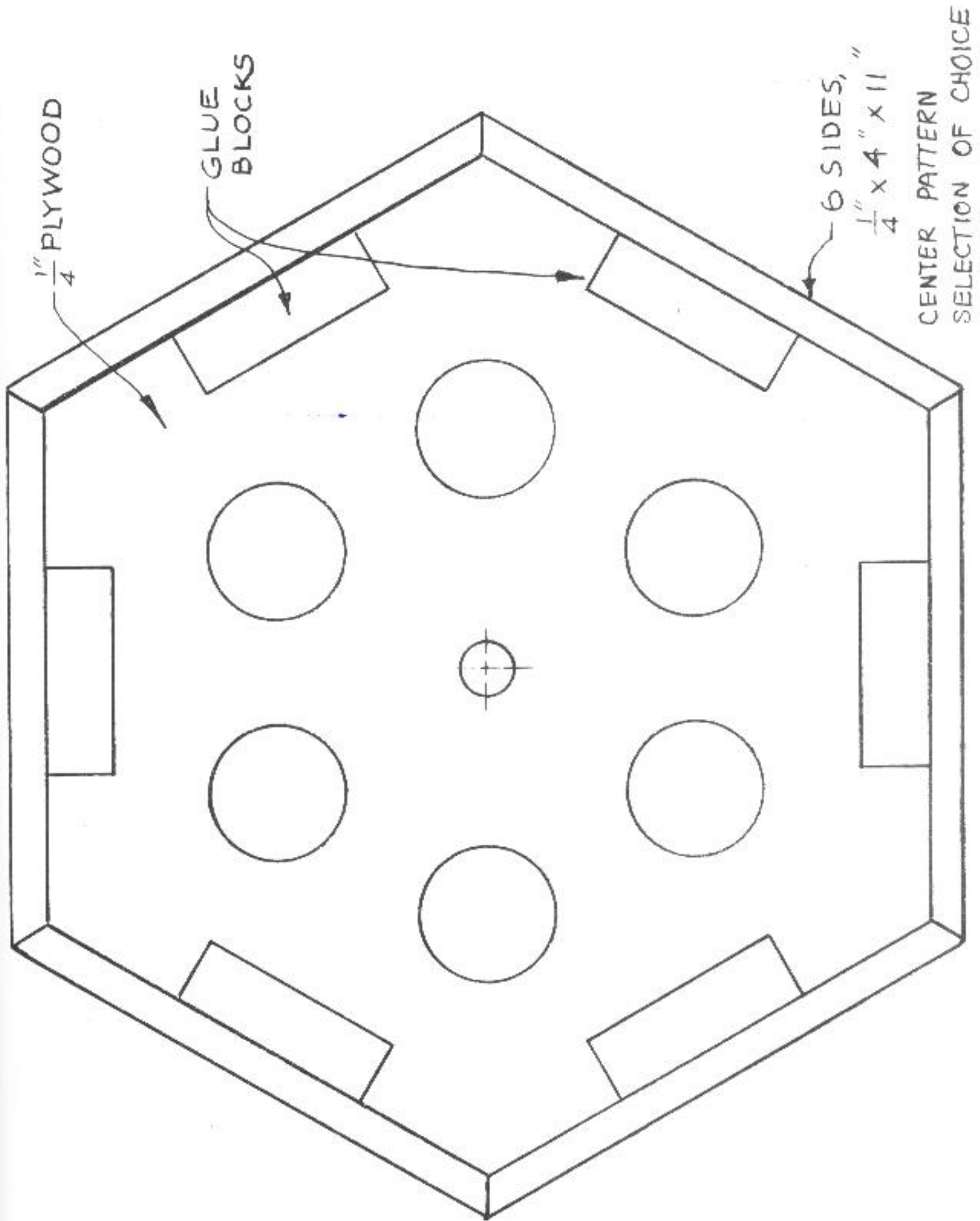

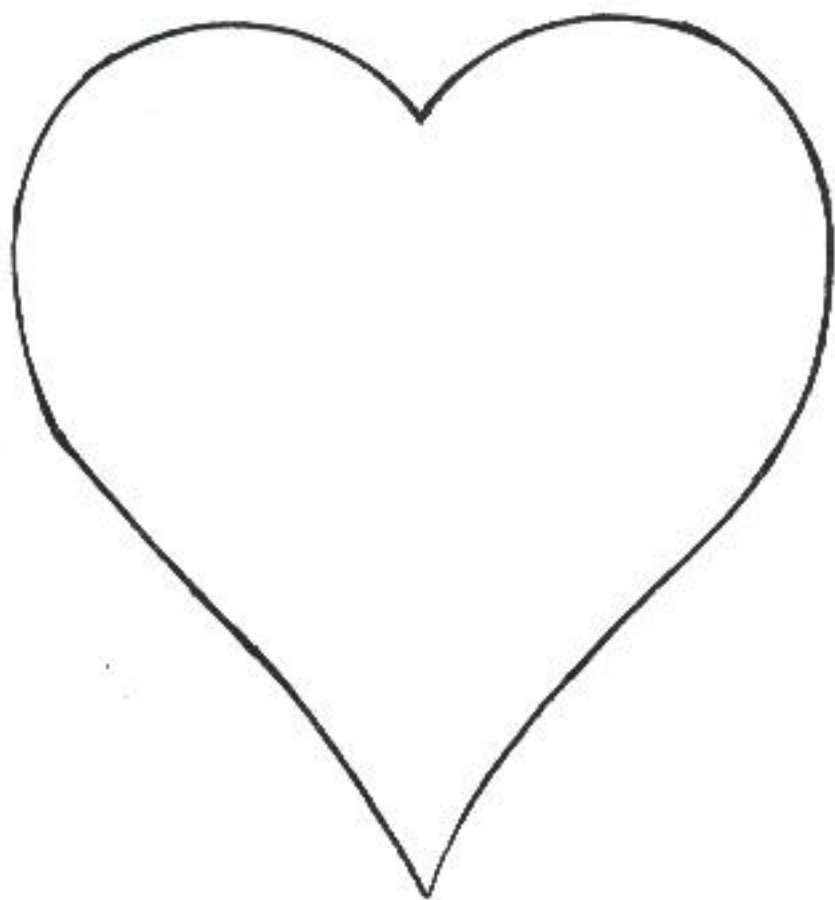
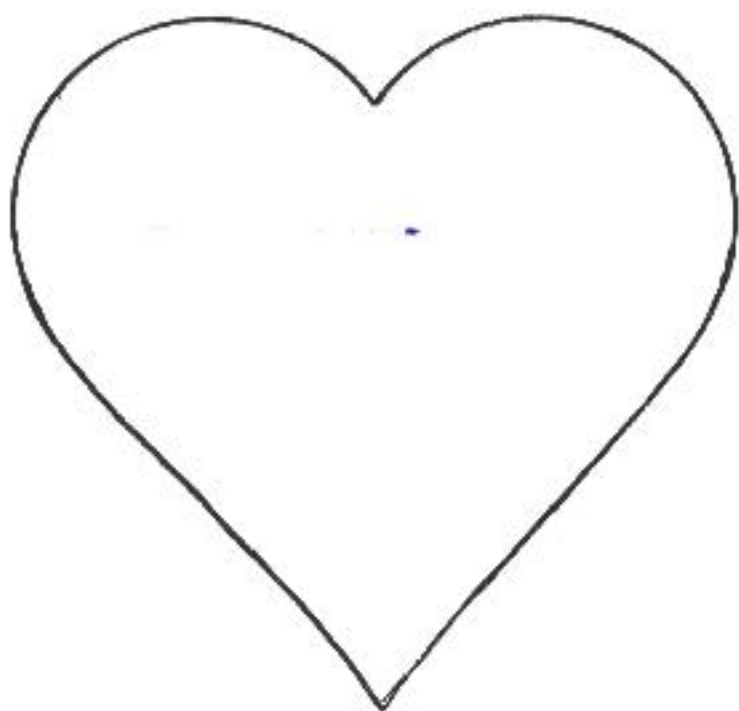
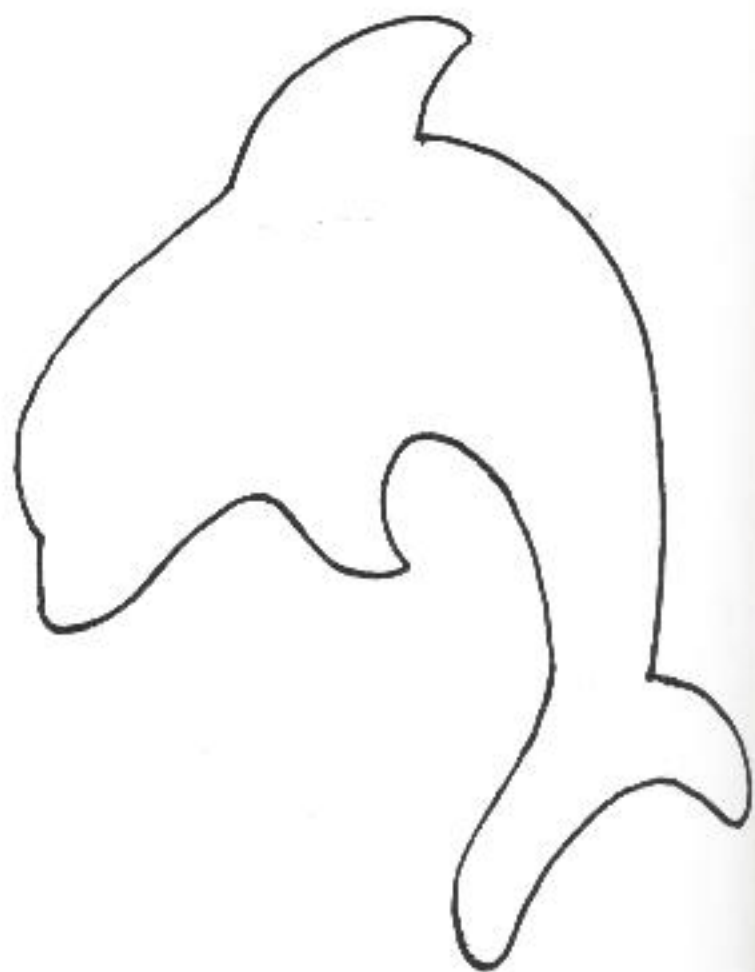
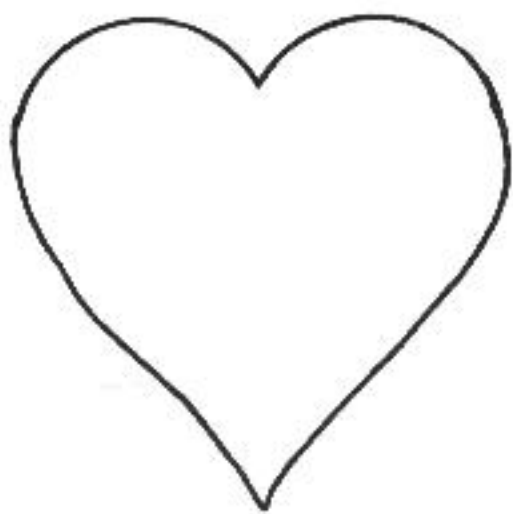

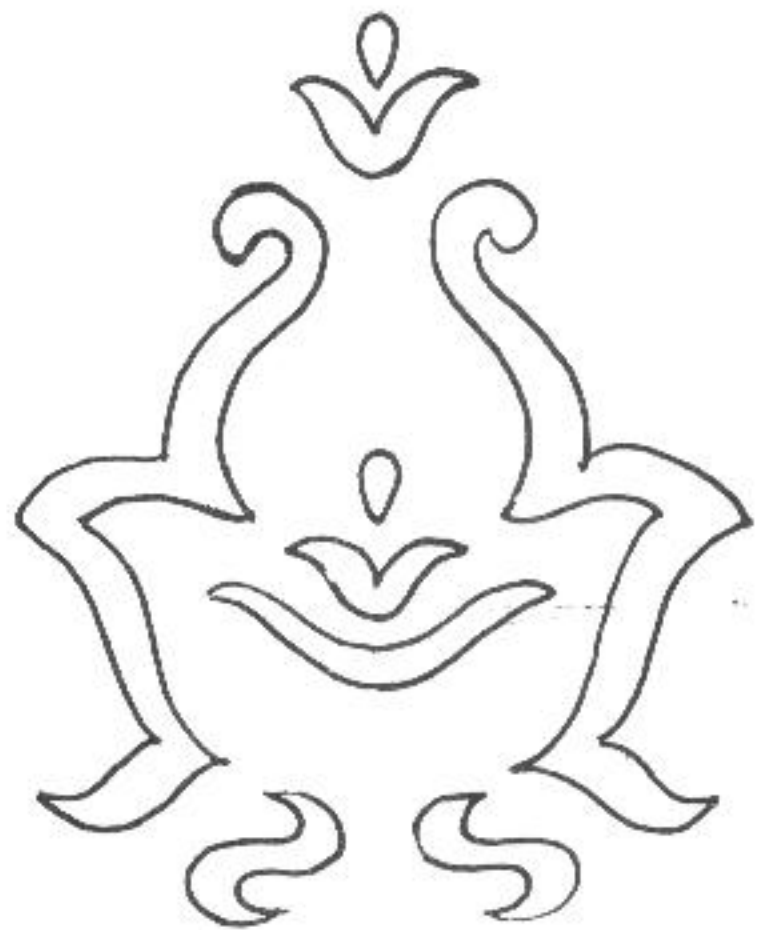
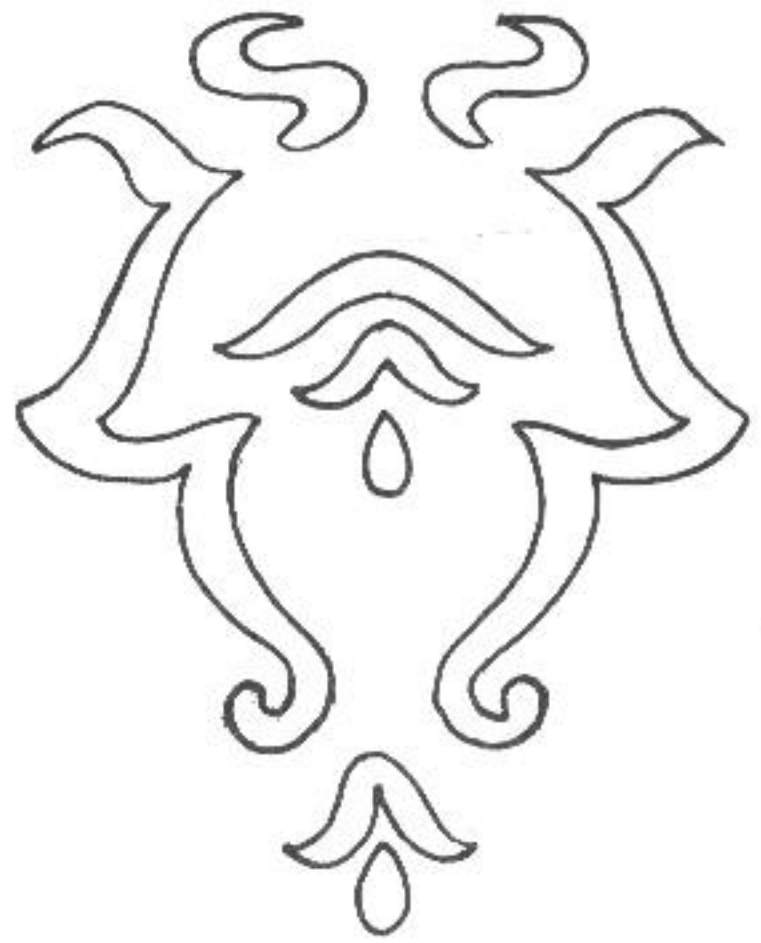
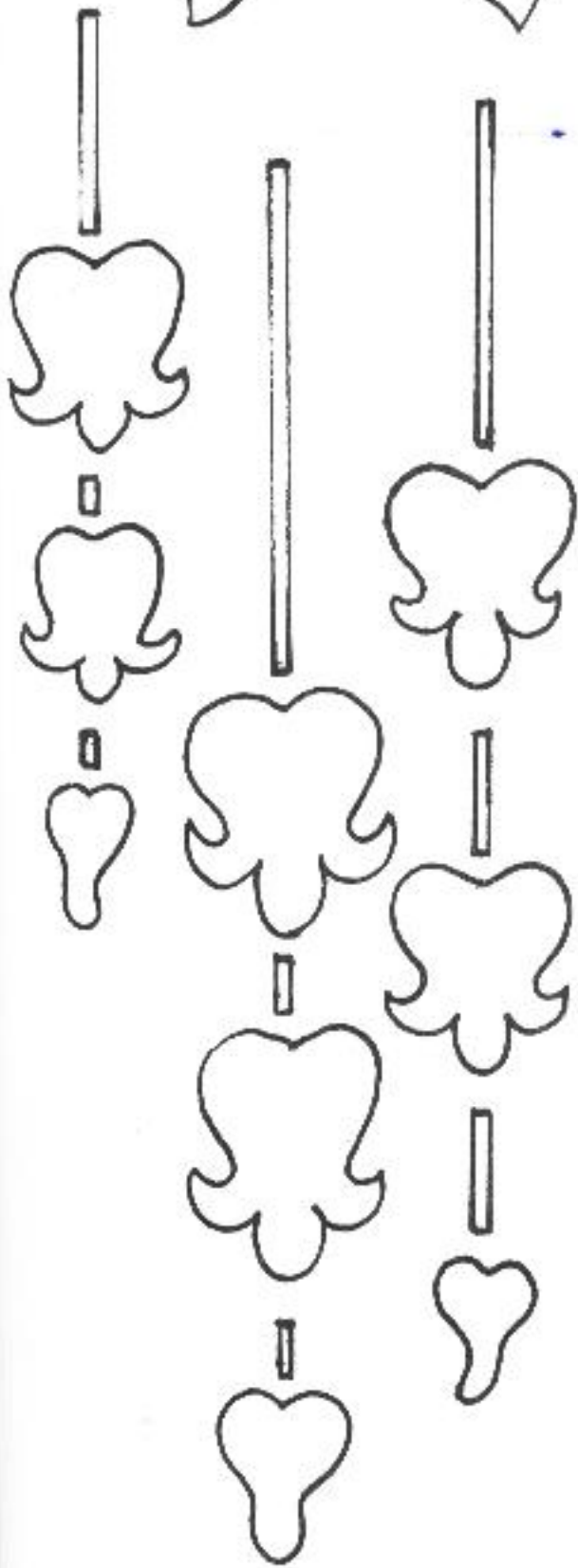

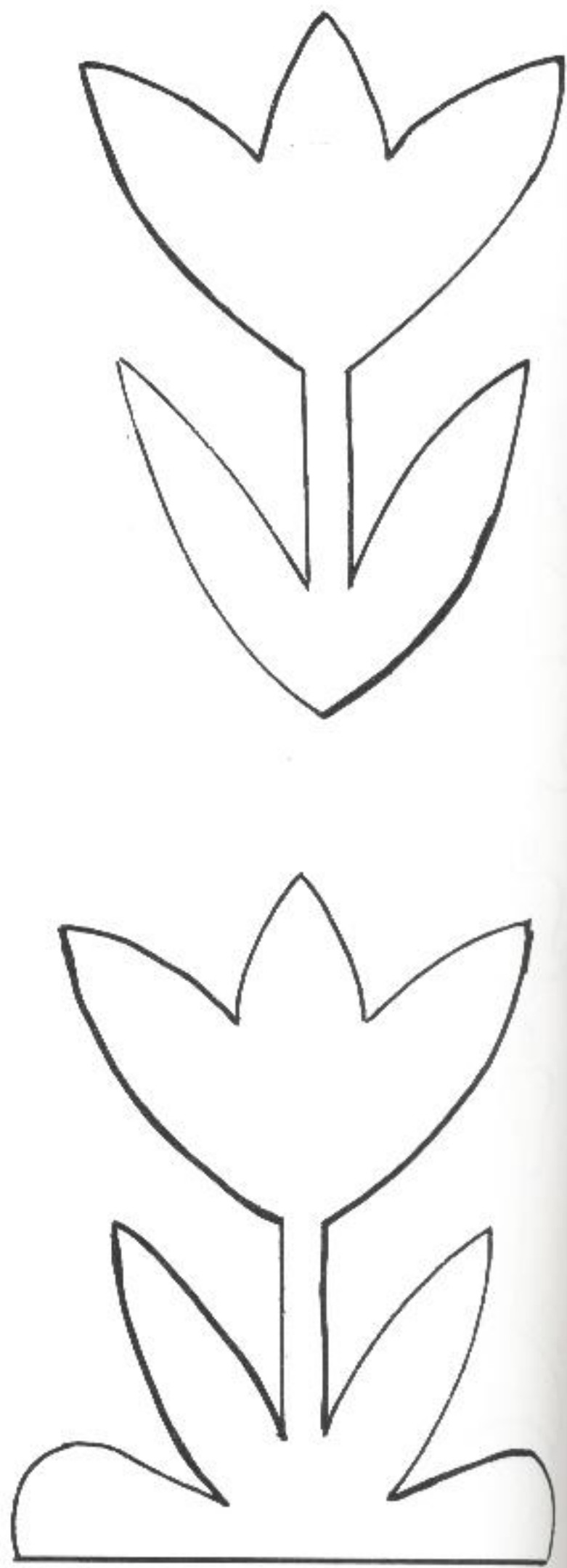
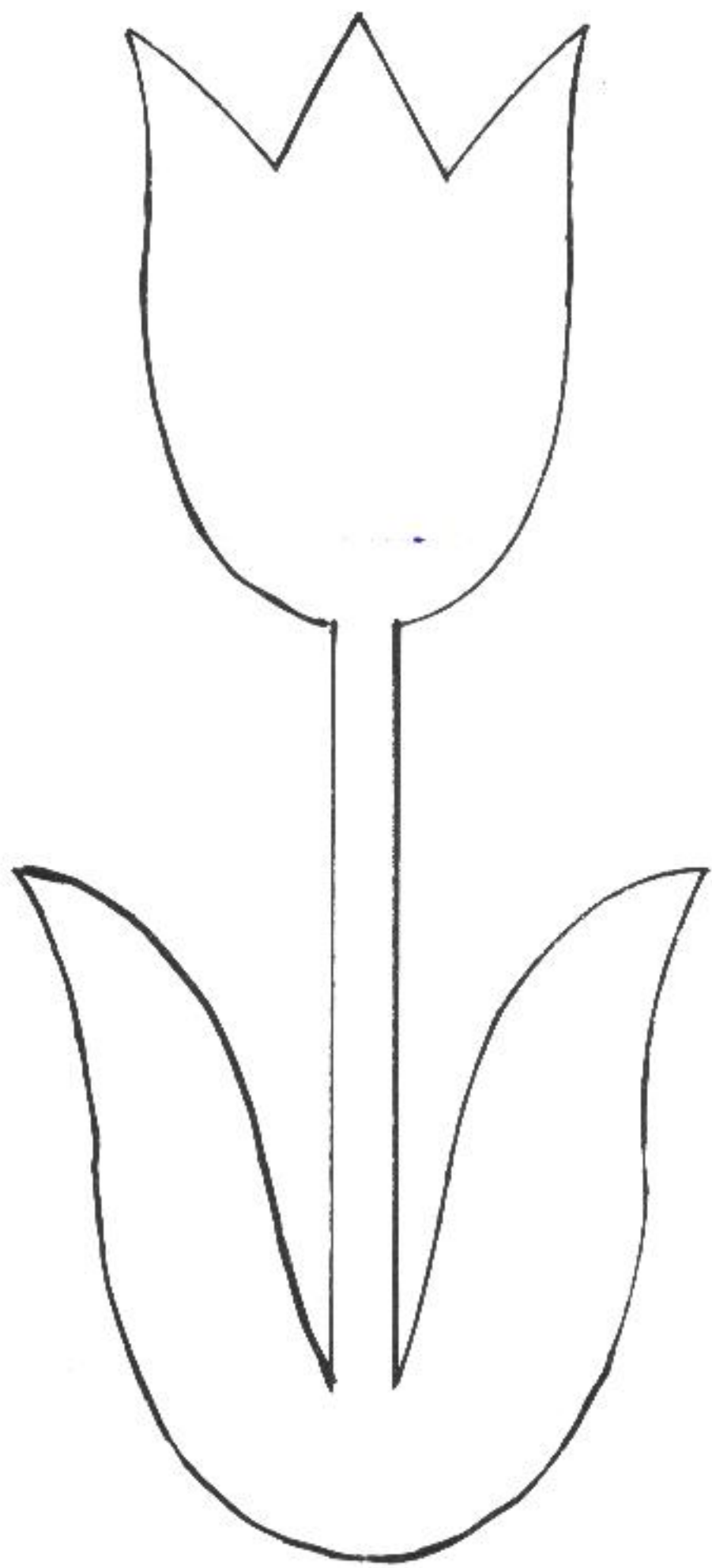



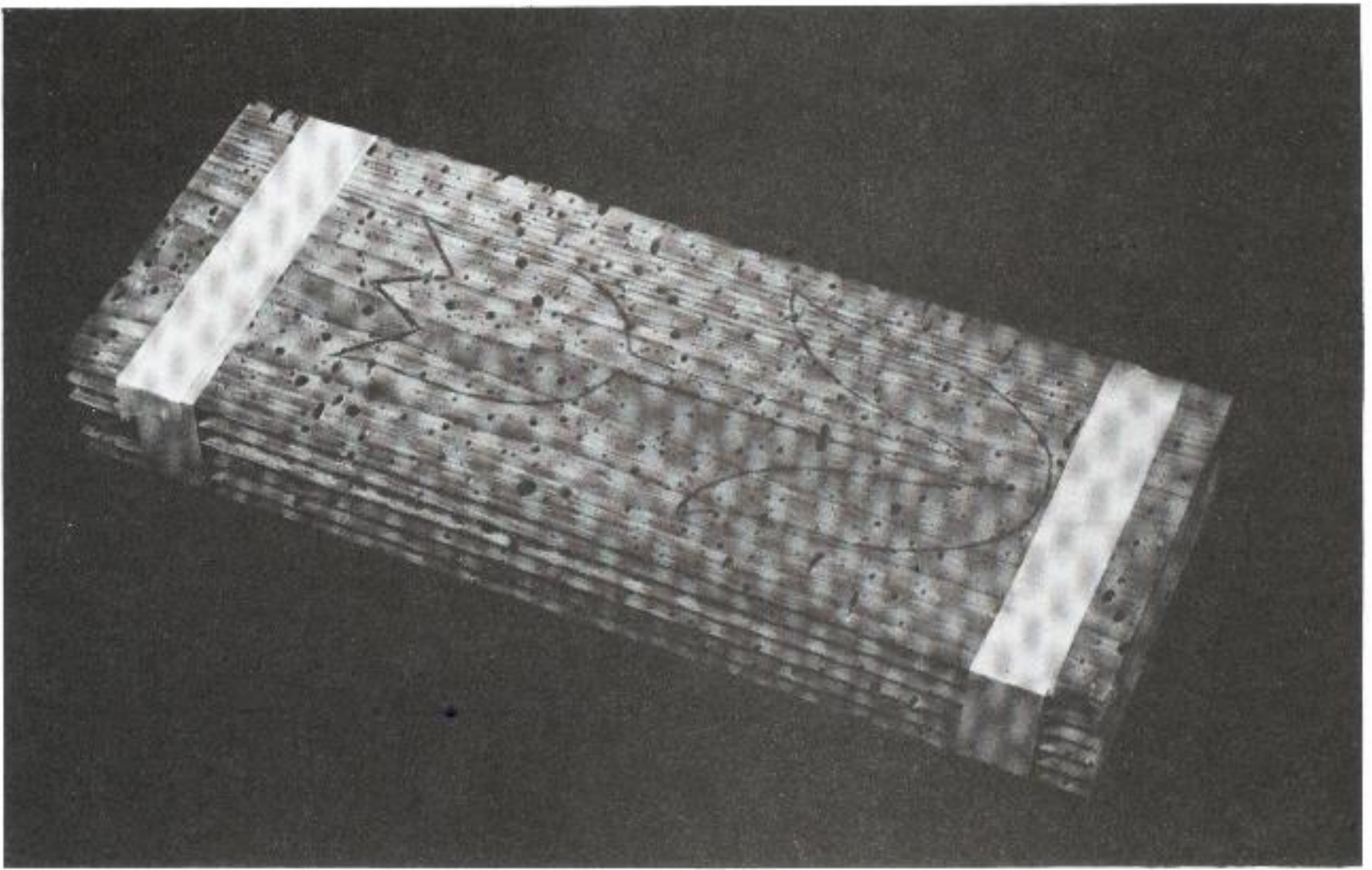

*With the pattern centered in sized stock with 60 degree edges, stack the boards together for multiple sawing.*

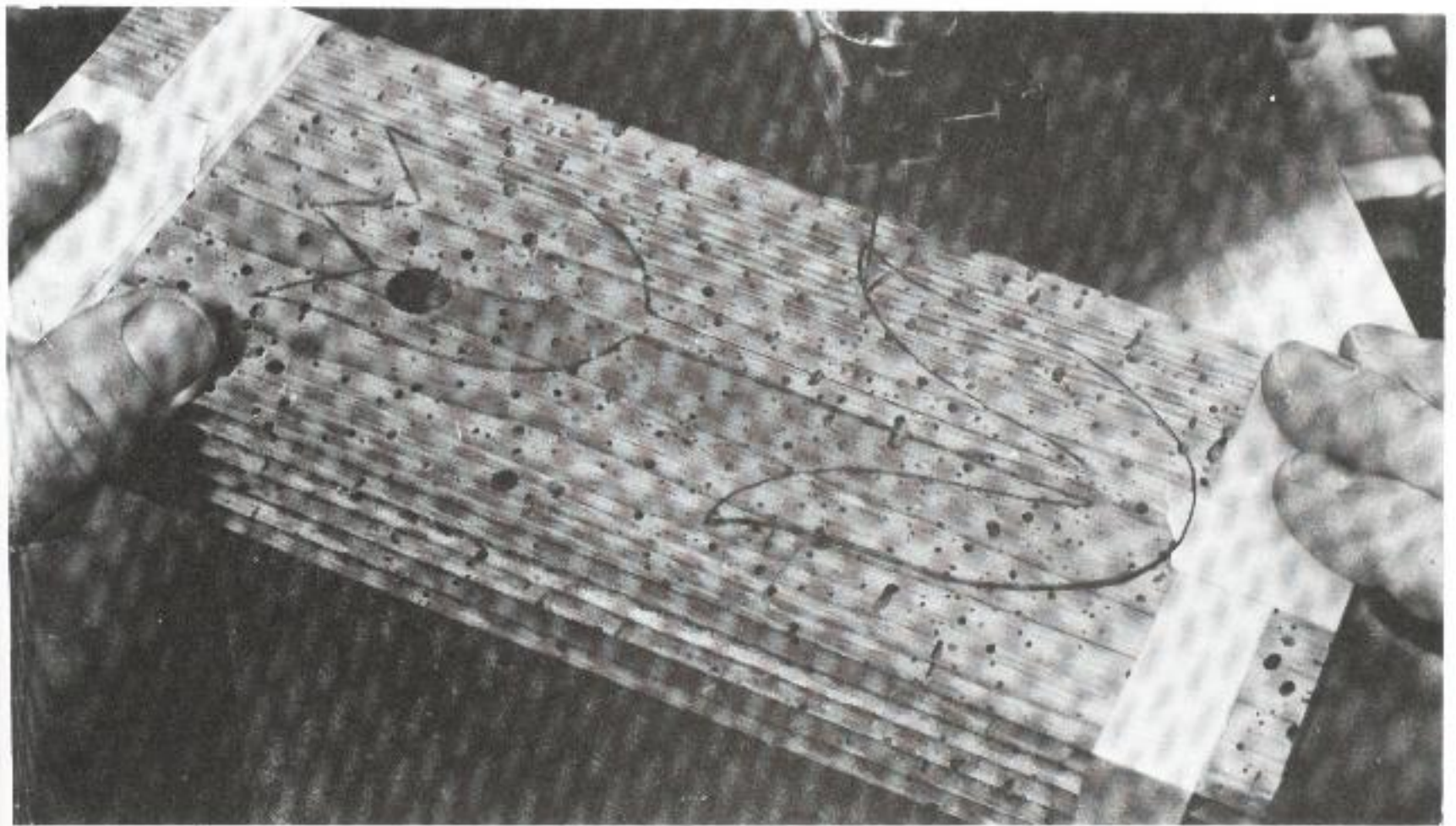

*Stack sawing is a process in which all six sides are cut at one time.*

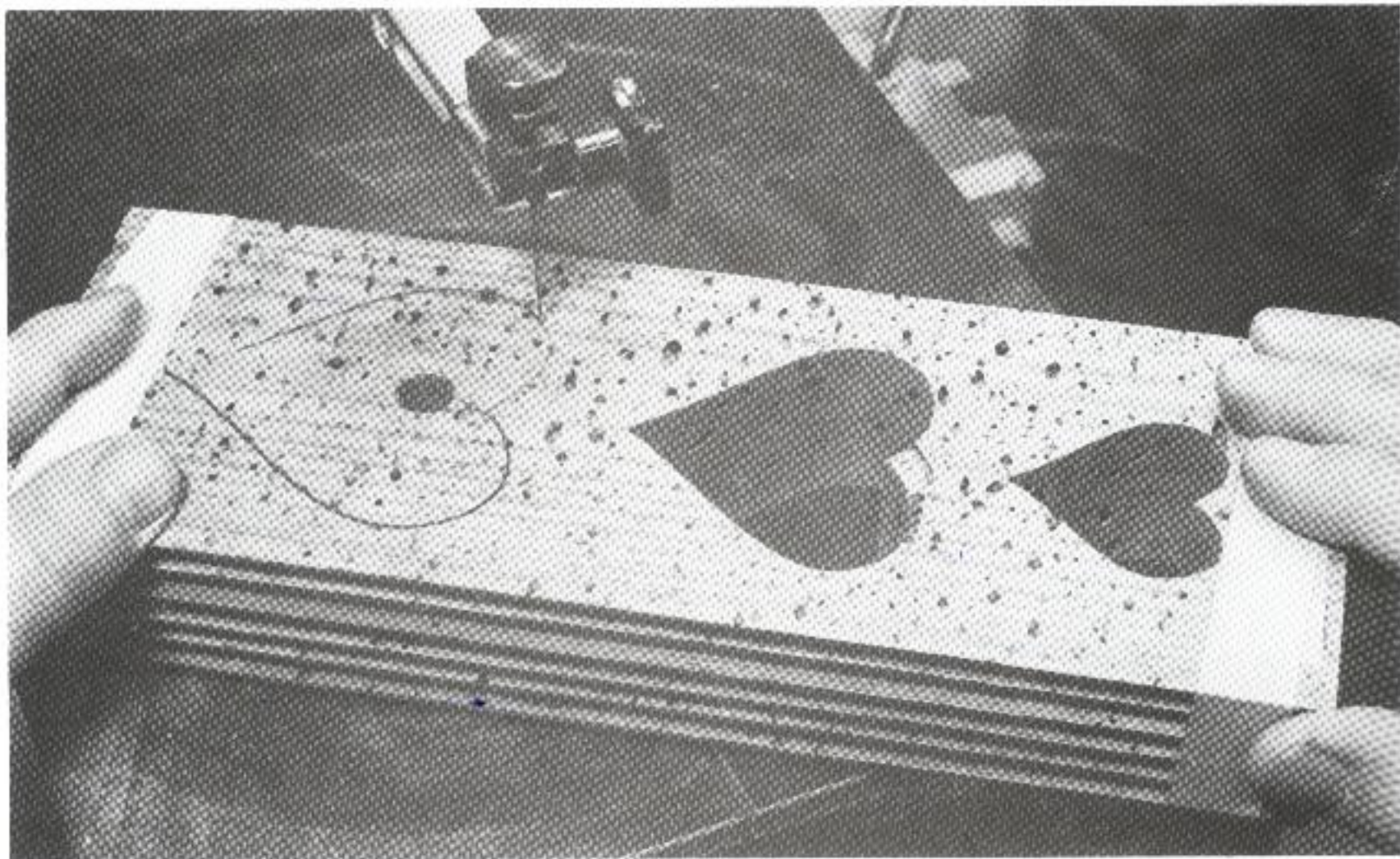

*Stack sawing for another lamp.*

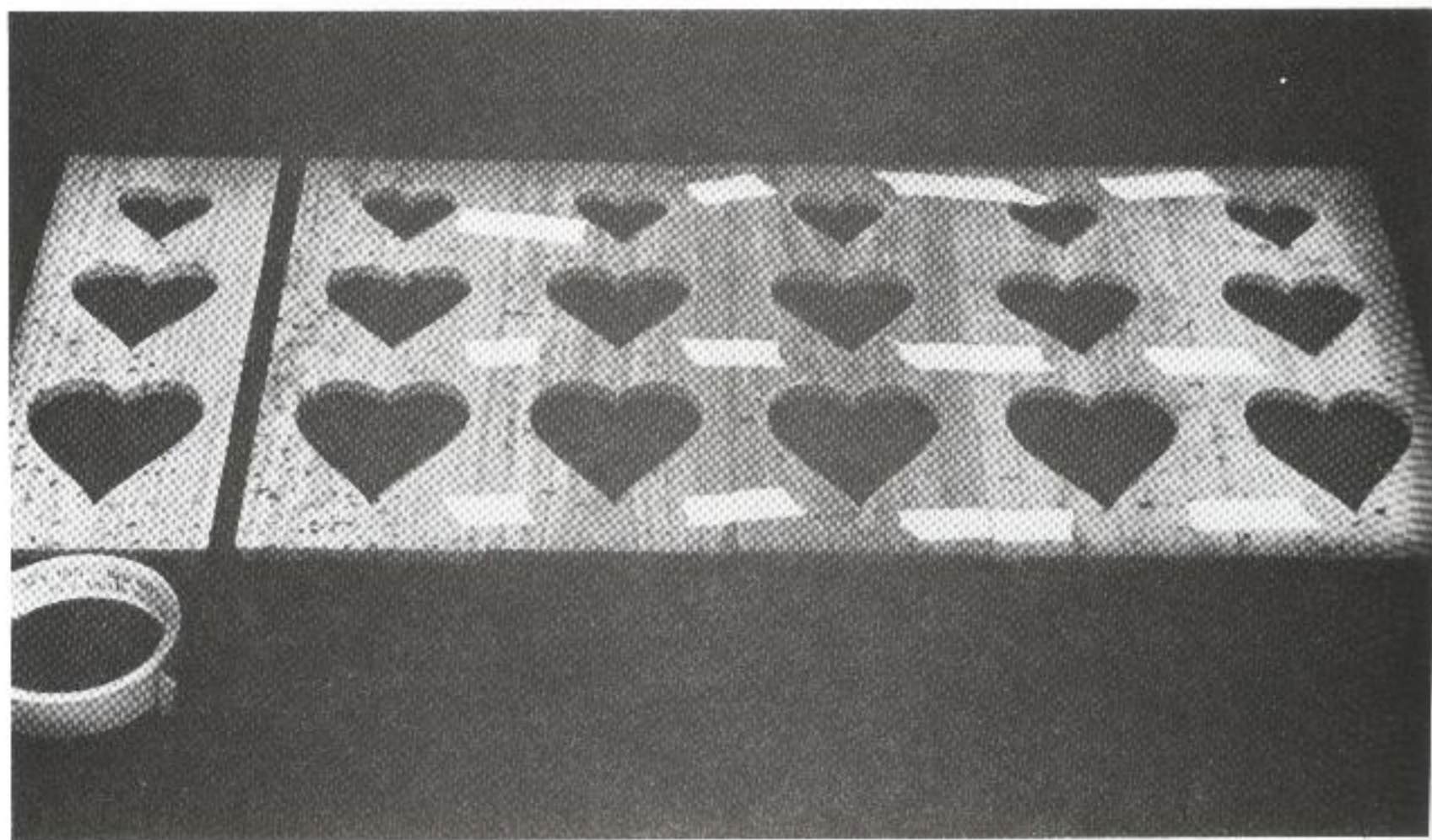

*Tape all six pieces together on the face side.*

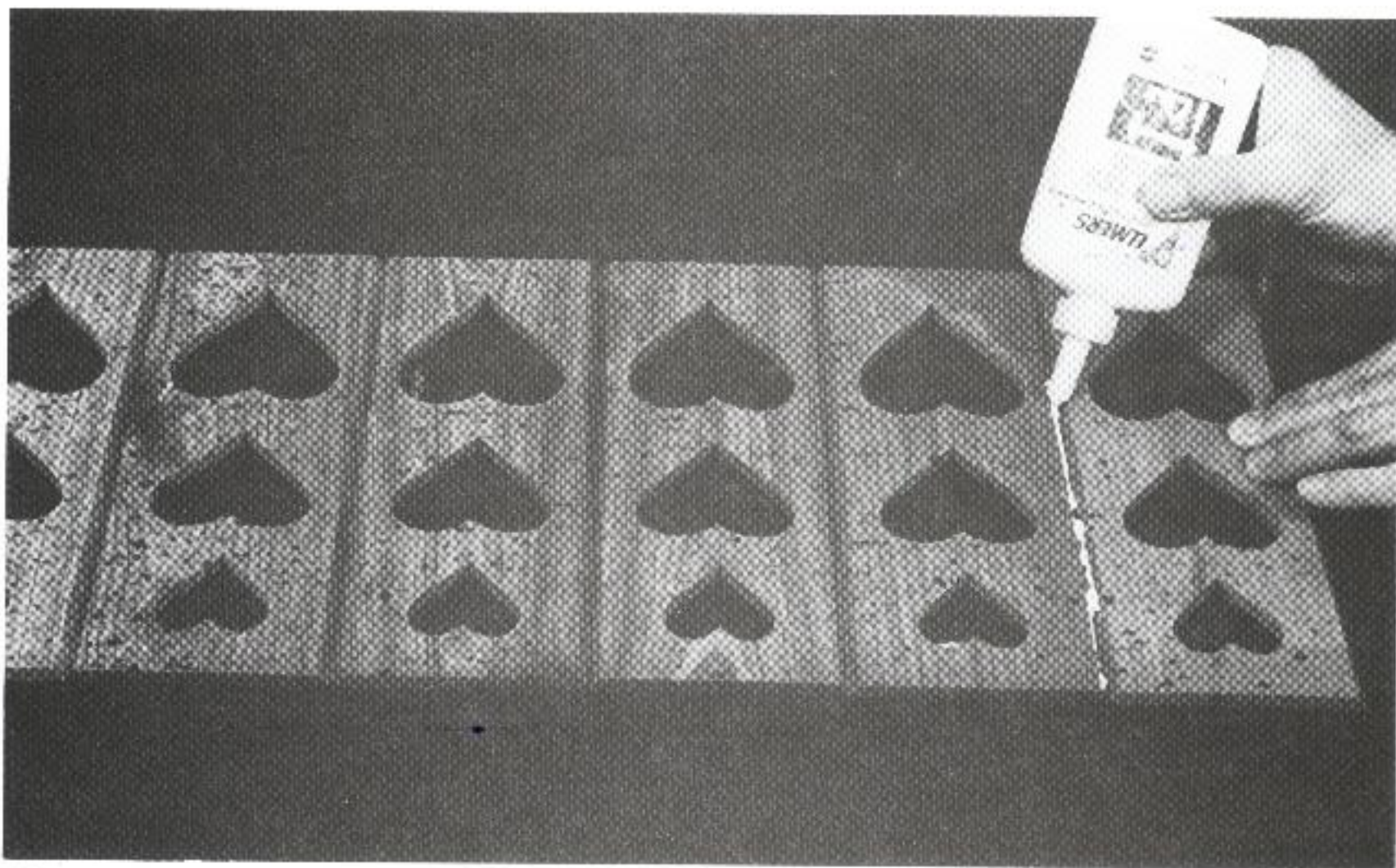

*Flip all taped pieces over and spread glue in the "V" openings.*

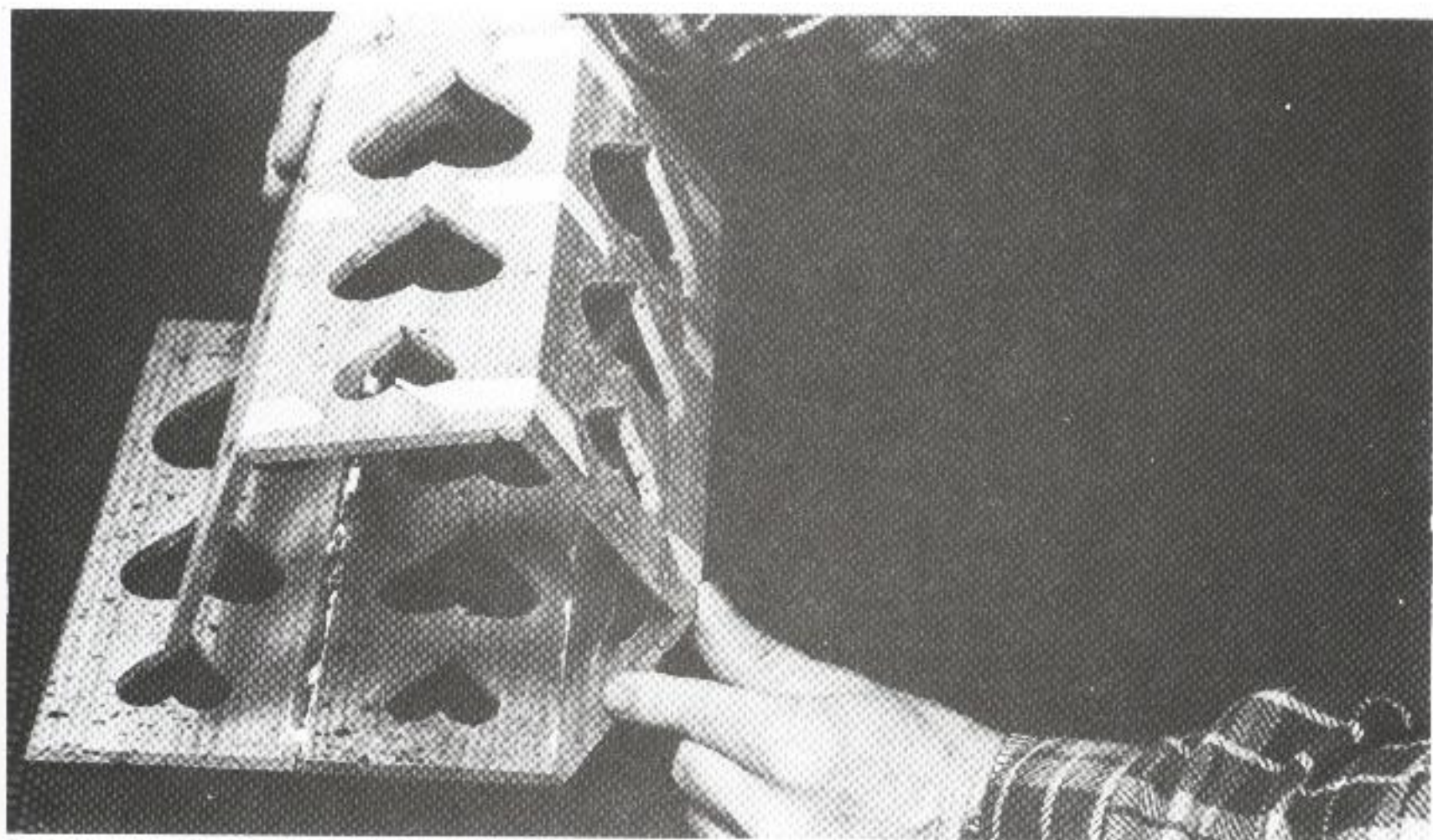

*Pull the assembly together. The tape acts as a hinge and clamp.*

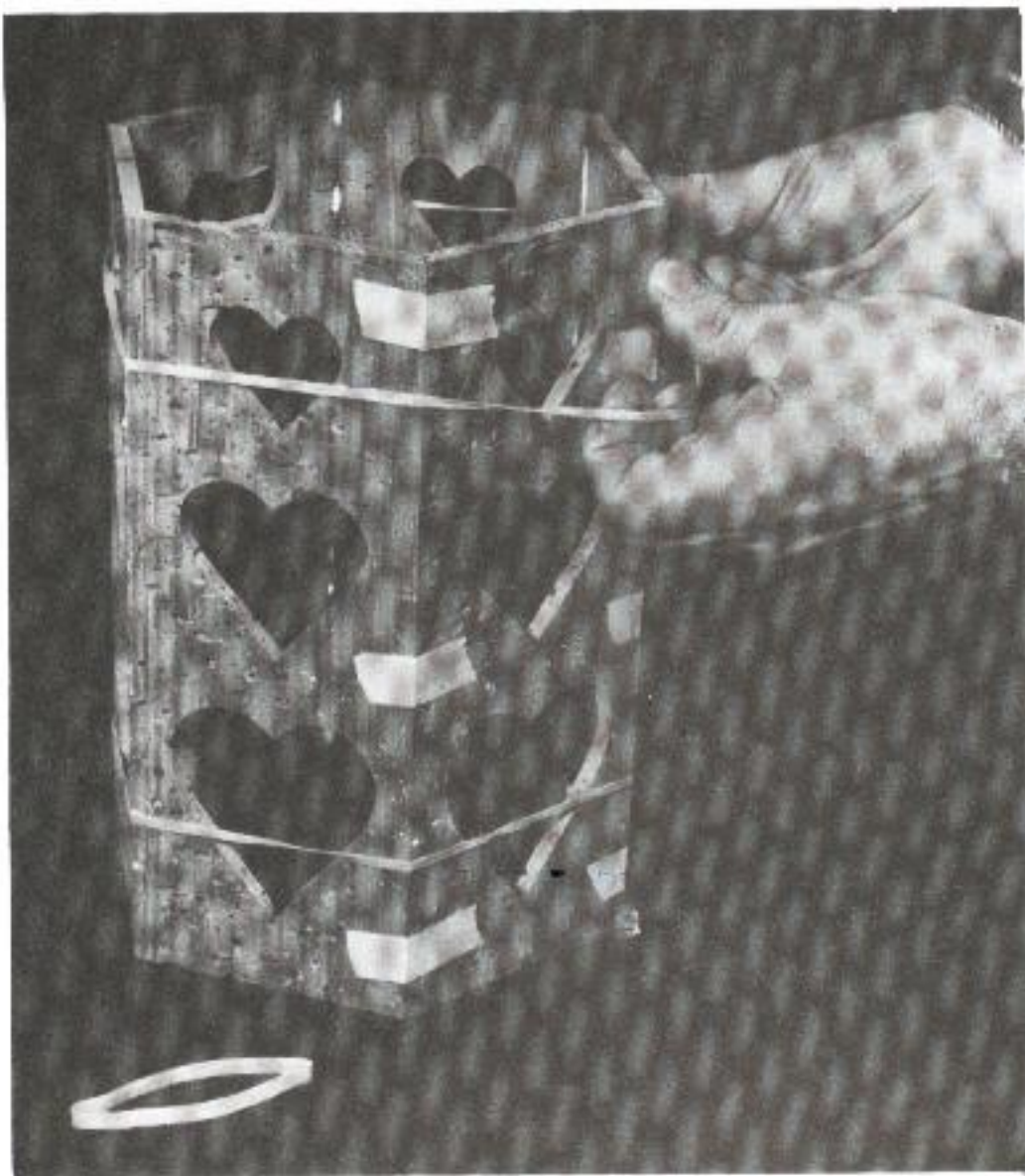

*A few heavy rubber bands provide the clamping pressure.*

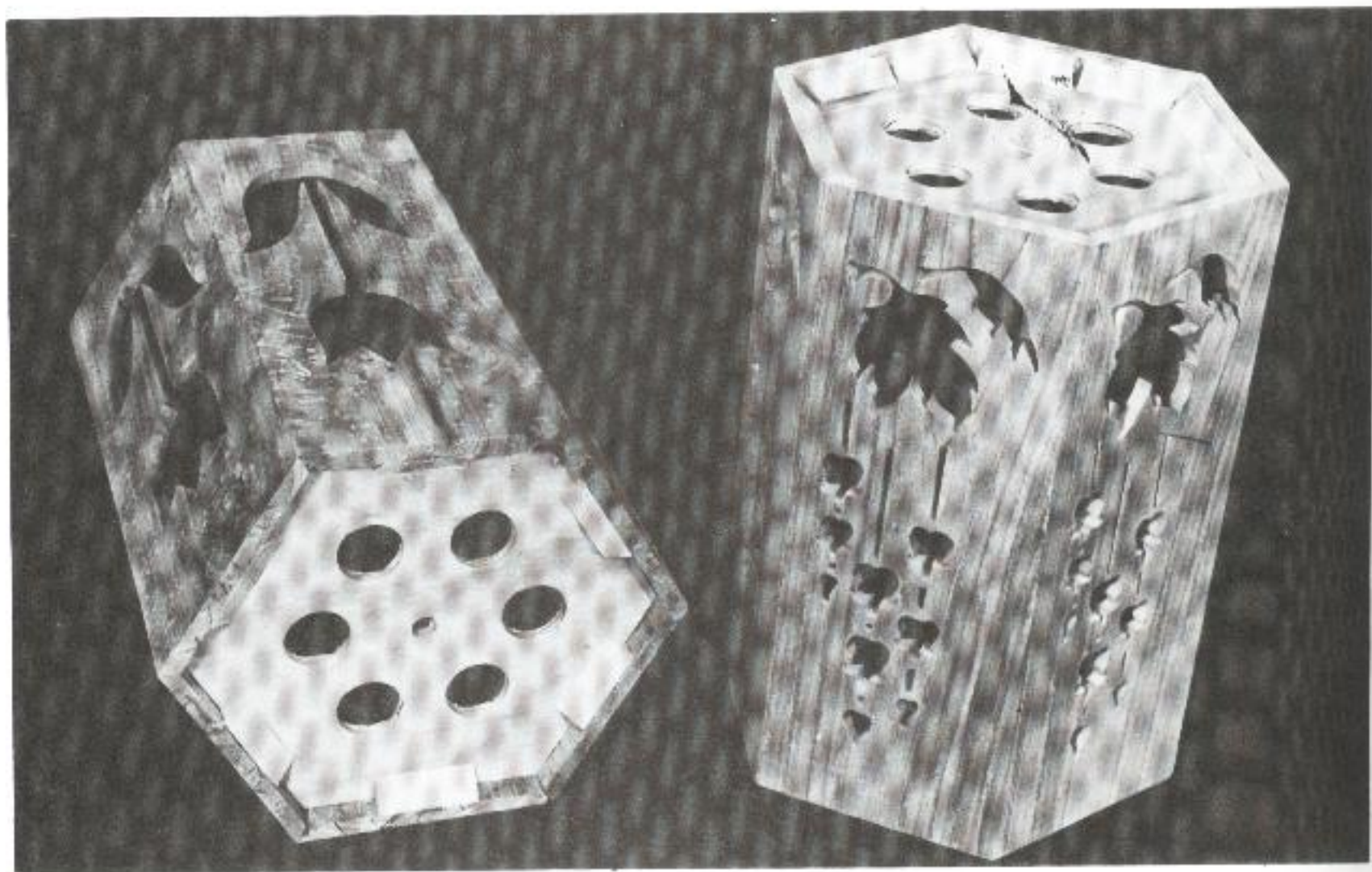

*The hex top is secured with triangular glue blocks.*