

**CHERRY BLOTCHES — SO GET OVER IT!**

We Test SawStop's  
Newest Machine



# POPULAR WOODWORKING

Learn How. Discover Why. Build Better.

FEBRUARY 2009 #174

## 7 Strategies For Better Drawers

**Tapered Legs:  
4 Craftsmen,  
4 Techniques**

**Teen Builds  
World-class Planes**

**How to Make a  
Ball & Claw Foot**

**Shaker Stepback  
For Flat-screen TVs**

popularwoodworking.com

US \$5.99

02

0 74470 01355 6

Display until February 9, 2009



42



55



60

## 42 Shaker Stepback

Don't let the size of this project put you off. Simple mortise-and-tenon joints and floating panels (and a little brute strength) combine to house all your 21st-century entertainment accoutrements.

BY MEGAN FITZPATRICK

## 50 The Art of Dovetailed Drawers

Details make the difference between fine furniture and pedestrian design – and drawers in particular reveal the care of the craftsman. Here, you'll get instruction for constructing elegant drawers for your finest projects.

BY MARIO RODRIGUEZ

## 55 Four Ways to Make Tapered Legs

Sit four woodworkers down at the same table and you'll get four different opinions (or more) on how to do things – such as how to make tapered legs. Here, each of the four chooses his tapered-leg weapon of choice: planer, jointer, table saw and band saw.

BY KEITH NEER, GLEN D.  
HUEY, ROBERT W. LANG &  
CHRISTOPHER SCHWARZ

## 60 The Barnsley Hay Rake Table

Inspired by both the Arts & Crafts movement and traditional agricultural tools of rural England, this massive oak table is awash in handworked details, including hand-forged iron buttons (though wood will work, too).

BY DON WEBER

## 66 D.L. Barrett & Sons: Planemakers

An award-winning plow plane that's near perfection was built by an 18-year-old maker. It was the second plane he'd ever built.

BY CHRISTOPHER SCHWARZ



66

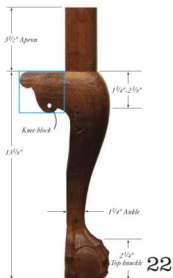

**10** The Map is Not The Territory  
**OUT ON A LIMB**  
 BY CHRISTOPHER SCHWARZ

**12** Moulding Cutterhead  
**LETTERS**  
 FROM OUR READERS

**16** A Hoseline Clothesline  
**TRICKS OF THE TRADE**  
 FROM OUR READERS

**22** Make a Ball & Claw Foot  
**ARTS & MYSTERIES**  
 BY ADAM CHERUBINI

**28** Toss Your Tape Measure  
**THE WOOD WHISPERER**  
 BY MARC SPAGNUOLO

**32** Low-profile Serving Tray  
**I CAN DO THAT**  
 BY LINDA WATTS

**36** SawStop Contractor Model  
**TOOL TEST**  
 BY OUR STAFF

**70** Finishing Cherry  
**FLEXNER ON FINISHING**  
 BY BOB FLEXNER

**74** Reuben Margolin  
**GREAT WOODSHOPS**  
 BY RAPHAEL ROSEN

**80** A Puzzling Beginning  
**OUT OF THE WOODWORK**  
 BY MICAELA R. EVANS

ON THE FEBRUARY COVER



Most woodworkers don't pay enough attention to the details of drawer construction. Mario Rodriguez shows how subtle changes make a difference. Page 50.

COVER PHOTO BY AL PARRISH



32



Video



Web Site



Slide Show

## Video Gallery

### Roy Underhill

One of the world's best-loved woodworkers, Roy Underhill, delivered the keynote address at the Woodworking in America conference. We've selected two of his most hilarious stories and posted videos so you can laugh along. Click the links below for "The Axe" and "Roubo, Jefferson and the Nickel."  
[popularwoodworking.com/video](http://popularwoodworking.com/video)  
[popularwoodworking.com/article/via](http://popularwoodworking.com/article/via)

## New This Month

### Woodworking in America

If you couldn't make the trip to Berea, Ky., for the Woodworking in America conference, you can still catch the excitement and information. We set up a special web page with links to a slide show, toolmakers and the sites of the many woodworking bloggers who captured images, videos and interviews.  
[popularwoodworking.com/article/via](http://popularwoodworking.com/article/via)

### Hay Rake Slide Show

You'll find more information on how to make the Sidney Barnsley-inspired Hay Rake table on our web site. We had far more pictures than we could use in the story, so we've posted those and a Google SketchUp model on our site.  
[popularwoodworking.com/feb09](http://popularwoodworking.com/feb09)

## Project Plans

### 'I Can Do That' Online

For two years, we've been designing good-looking projects that can be built with a solid set of basic tools. And now we've posted them all on the "I Can Do That" page on our site (where you can also download our free manual on how to get started in woodworking).  
[popularwoodworking.com/icandothat](http://popularwoodworking.com/icandothat)

## Contest

### Enter Now: This Delta Saw Could Be Yours



Enter for your chance to win a Delta 10" table saw, just by answering three simple questions!

This left-tilting hybrid saw (model 36-717B) features a Biesemeyer fence and table board, as well as a deluxe miter gauge, a 1<sup>3</sup>/<sub>4</sub>-hp motor that can be wired for either 120 or 240 volts, a deluxe transparent blade guard with a splitter and anti-kickback fingers and more.

Enter today and it could be yours. Hurry! The contest ends on Jan. 31, 2009.  
[popularwoodworking.com/delta](http://popularwoodworking.com/delta)

## And More!

Visit [popularwoodworking.com/feb09](http://popularwoodworking.com/feb09) to find a complete list of all the online resources for this issue – including videos, additional drawings and photos.

## popularwoodworking.com

- [Contact Customer Service](http://popularwoodworking.com/magazines)
- [Free Project Plans](http://popularwoodworking.com/projects)
- [Article Index](http://popularwoodworking.com/articleindex)
- [Tool Reviews](http://popularwoodworking.com/tools)
- [Editor Blogs](http://popularwoodworking.com/blogs)
- [Writer's Guidelines](http://popularwoodworking.com/writersguidelines)
- [Contact the Staff](http://popularwoodworking.com/contactus)



**Chris Storb** is a conservator of furniture and woodwork at the Philadelphia Museum of Art. For 25 years he has studied, restored, conserved and made furniture and wooden objects. Storb specialized in the restoration of 17th-, 18th- and 19th-century American furniture in a private practice, which he established and successfully maintained for 15 years before joining the museum staff.

Recently, he began co-authoring a series of articles on the life and work of the English-born joiner John Head (1688-1754), who arrived in Philadelphia in 1717.

In this issue, Arts & Mysteries author Adam Cherubini tapped Chris for his expertise and help in carving a ball and claw foot (page 22).



**Keith Neer** For the last 37 years, Keith has "practiced" the craft of woodworking and made numerous family pieces of furniture with an occasional commission piece thrown in. In 2005 he retired from industry to follow a dream and started Clermont Woodworking and Design.

Since retirement Keith has worked full time as a furniture designer and builder. He restores heirloom furniture and teaches woodworking at local retailers and in his shop outside Cincinnati. You can see his work and his shop at [Clermontwoodworking.com](http://Clermontwoodworking.com).



**Mario Rodriguez** has more than 30 years of experience as a woodworking teacher, writer and builder. After earning a bachelor's degree in art and applied design and completing his apprenticeship, he established his own shop in Brooklyn, N.Y., and worked with the area's leading architects, designers and collectors. His work has been featured in a number of publications, including *Architectural Digest* and *The New York Times*.

After teaching for almost 18 years in the Restoration Department at the New York-based Fashion Institute of Technology, Mario now teaches at the Philadelphia Furniture Workshop ([philadelphiafurnitureworkshop.com](http://philadelphiafurnitureworkshop.com)).

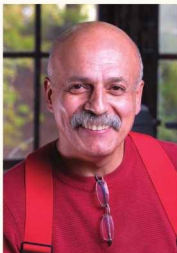

**PUBLISHER & GROUP EDITORIAL DIRECTOR**  
Steve Shaney

**EDITOR** Christopher Schwarz  
x11407 ■ [chris.schwarz@fwmedia.com](mailto:chris.schwarz@fwmedia.com)

**ART DIRECTOR** Linda Watts  
x11396 ■ [linda.watts@fwmedia.com](mailto:linda.watts@fwmedia.com)

**SENIOR EDITOR** Robert W. Lang  
x11327 ■ [robert.lang@fwmedia.com](mailto:robert.lang@fwmedia.com)

**SENIOR EDITOR** Glen D. Huey  
x11293 ■ [glen.huey@fwmedia.com](mailto:glen.huey@fwmedia.com)

**MANAGING EDITOR** Megan Fitzpatrick  
x11348 ■ [megan.fitzpatrick@fwmedia.com](mailto:megan.fitzpatrick@fwmedia.com)

**ASSOCIATE EDITOR FOR THE WEB** Drew DePenning  
x11008 ■ [drew.depenning@fwmedia.com](mailto:drew.depenning@fwmedia.com)

**PHOTOGRAPHER** Al Parrish

**CONTRIBUTING EDITORS**  
Adam Cherubini, Bob Flexner, Troy Sexton

**F+W MEDIA, INC.**

**CHAIRMAN & CEO** David Nussbaum

**CFO** Jim Ogle

**PRESIDENT** Sara E. Domville

**SENIOR VP, MANUFACTURING & PRODUCTION** Phil Graham

**VP, MANUFACTURING** Barbara Ann Schmitz

**EXECUTIVE VP, MEDIA** John Lerner

**VICE PRESIDENT, CIO** Mike Kuehn

**VP, CONSUMER MARKETING** Sara DeCarlo

**DIRECTOR, BUSINESS PLANNING** Tom Wiant

**CONFERENCE DIRECTOR** Sara Dumford

**CIRCULATION DIRECTOR** Linda Engel

**NEWSSTAND DIRECTOR** Susan Rose

**PRODUCTION COORDINATOR** Vicki Whitford

**ADVERTISING**

**ADVERTISING DIRECTOR** Don Schroder  
331 N. Arch St., Allentown, PA 18104  
TEL 610-821-4425; FAX 610-821-7884  
[d.schroder@verizon.net](mailto:d.schroder@verizon.net)

**DISPLAY & CLASSIFIED ADVERTISING**  
**SALES COORDINATOR**

Krista Morel  
TEL 513-531-2690 x11311  
[krista.morel@fwmedia.com](mailto:krista.morel@fwmedia.com)

**SUBSCRIPTION SERVICES:** Subscription inquiries, orders and address changes can be made at [popularwoodworking.com](http://popularwoodworking.com) (click on "Customer Service"), or by mail: *Popular Woodworking*, P.O. Box 420235, Palm Coast, FL 32142-0235. Or call toll-free 877-860-9140 or 386-246-3369. Include your address with all inquiries. Allow 6 to 8 weeks for delivery.

**NEWSSTAND DISTRIBUTION:** Curtis Circulation Co., 730 River Road, New Milford, NJ 07646

**ATTENTION RETAILERS:** To carry *Popular Woodworking* in your store, call 800-894-4656 or write Magazine Retail Sales, P.O. Box 5014, Iola, WI 54945-5014.

**BACK ISSUES** are available. Call 800-258-0929 for pricing or visit [popularwoodworking.com](http://popularwoodworking.com). Send check or money order to: *Popular Woodworking* Back Issues, F+W Media Products, 700 E. State St., Iola, WI 54990. Please specify publication, month and year.

Copyright ©2009 by F+W Media, Inc. All rights reserved. *Popular Woodworking* is a registered trademark of F+W Media, Inc.



# The Map is Not The Territory

A college professor who taught Zen Buddhism once told me the following odd story about a test he gave to his students.

The test had only one question: "Explain the nature of Zen Buddhism."

All the students scribbled furiously for a couple hours to answer it—except for one guy. He sat quietly at his desk during the exam. At the end of the two hours he turned in his blue examination booklet.

Except for the student's name on the front, his test booklet was empty.

The professor thought about this for a moment and then gave the following grade: "A" for content. And "F" for grammar.

The process of learning woodworking is filled with odd dichotomies like this. On the one hand, you can read about woodworking for years and never take it all in.

And yet you will then know nothing of woodworking.

At the same time, it's troubling when you meet woodworkers who have been building their entire lives but have only a modest grasp of the complexity of the craft.

True story: I once met a career cabinetmaker in Indiana who showed me his work. When we were examining a pie safe he pointed out how the panel in the door had cracked. He mentioned that this was a problem he had all the time.

"No matter how many nails I use, the panel still cracks," he told me. "Big nails, little nails, nothing works."

Work itself will also give you nothing.

Last weekend we finished up our first-ever Woodworking in America conference (go to our web site for photos, stories and video highlights). There were a lot of lectures. A bunch of PowerPoint presentations. And reams of paper that explained everything from the price of an 18th-century chisel to the over-arching tenets of contemporary furniture design.

But what was really amazing for me was to hear the words, read the text and then see how the work progressed. When I watched Contributing Editor Adam Cherubini sharpen a chisel it was like kissing an electrical outlet. Wow. That's how he does it. It is simpler than I thought.

When I came home and tried it myself, I fumbled a bit. But after a few minutes it clicked. I couldn't say, however, if it was my studying, my observations or the act of sharpening that made the edge keen. It just clicked.

So here's the point: You need to do three things to really master a skill. Read about woodworking to understand the rules. Watch someone else do the task so you can see how fluid the body mechanics can be. And then do it.

But be prepared for your skill to come from some place undefinable.

As Juvenal, a Roman satirist, put it: "I cannot describe it, I can only feel it." PW



*Christopher Schwarz*

PHOTO BY THE AUTHOR

## Customer Service

*How can I contact customer service with questions regarding my subscription, including a lost or damaged issue?*

Visit [popularwoodworking.com/customer-service](http://popularwoodworking.com/customer-service). Or write to *Popular Woodworking*, P.O. Box 420235, Palm Coast, FL 32142-0235. Or, if you prefer the telephone, call toll-free 877-860-9140 and a customer service representative will be happy to help you.

*When does my subscription expire?*

The date of your subscription expiration appears on your magazine mailing label, above your name. The date indicates the last issue in your subscription.

*Can I get back issues of Popular Woodworking?*

Back issues are available while supplies last. Visit [popularwoodworking.com/backissues](http://popularwoodworking.com/backissues). Or if you know the exact month and year of the issue you want, call our customer service department toll-free at 800-258-0929 to order.

*What if I want more information about the projects and tools I read about in Popular Woodworking?*

For all editorial questions, please write to *Popular Woodworking* Editorial, 4700 E. Galbraith Road, Cincinnati, OH 45236. Or e-mail [popwood@fwmedia.com](mailto:popwood@fwmedia.com).

*Does Popular Woodworking offer group discounts?*

Group discounts are available by special arrangement with the publisher. For more details, send an e-mail to [Debbie.Paoello@fwmedia.com](mailto:Debbie.Paoello@fwmedia.com) or call 513-531-2690 ext 11296.

## Our Privacy Promise to You

We make portions of our customer list available to carefully screened companies that offer products and services we believe you may enjoy. If you do not want to receive offers and/or information, please let us know by contacting us at:

List Manager, F+W Publications  
4700 E. Galbraith Road  
Cincinnati, OH 45236

## Safety Note

Safety is your responsibility. Manufacturers place safety devices on their equipment for a reason. In many photos you see in *Popular Woodworking*, these have been removed to provide clarity. In some cases we'll use an awkward body position so you can better see what's being demonstrated. Don't copy us. Think about each procedure you're going to perform beforehand.

# Moulding Cutterhead Another Way to Trim Flush

I would like to comment on the “Flush-cutting jig” article (*Popular Woodworking* November 2008, issue #172). This article presents a unique solution to an often-incurred problem, and I will try it on my next project involving solid-wood edging surrounding a plywood wall piece. But I would like to offer a suggestion. Because I am reluctant to spend more money on a stacked dado blade set than I spent on my table saw, I have yet to produce a smooth, flat-bottomed dado. I suggest using a moulding cutterhead installed on the saw, using a 1”-wide set of planer cutters. In my experience, this setup is far superior to any stacked dado set and is far cheaper, to boot.

—Carl Carlman, Dearborn, Michigan

*A moulding cutterhead with the appropriate knives will do the job. However, most woodworkers would have to purchase a moulding cutterhead, while a stacked dado set is more than likely going to be part of one’s inventory.*

*Also, I question the results from a three-knife cut from the moulding head versus the smoothness of a dado stack. And pricing is not all that different between the two products if you do need to make a purchase.*

*Of course, one benefit of a moulding cutterhead is that you can also purchase additional knife profiles to make mouldings. Some woodworkers prefer that moulding method to a router table.*

—Glen D. Huey, senior editor



## Are Published Furniture Plans Fair Game for Manufacture?

Thank you for running Jon Shackelford’s article, “Copying Famous Furniture,” in the November 2008 issue (#172). But it leaves me with questions:

One of Shackelford’s examples is Moser’s continuous arm chair. Moser, as have others, published a book on the techniques, dimensions and drawings necessary to produce his chair; and his book includes instructions on how to make the production tooling to manufacture the chair. I have his book. Do I have an implicit license to produce a set of chairs for my personal use? Does his including the production tooling designs permit me to manufacture the chair?

Also, does the owner of an antique have the right to prohibit others from reproducing it? (I had thought so, but the article suggests not.) For example, if a museum owns and displays an 18th-century Windsor chair and permits me to photograph it, does the museum have any right to prohibit me from producing or manufacturing it? If so, would the piece’s fame affect that answer – for example, consider the iconic Pennsylvania Dutch dowry chest. Would the fact that the museum permitted a measured drawing to be taken and published affect that answer?

—Larry Root, via e-mail

*It does appear to give mixed signals when innovators (such as Thos. Moser in your example)*

*protect their designs with patents (or trademarks or copyrights) and at the same time teach people how to reproduce them in a how-to book or article. Speaking generally, however, an author/inventor (like Moser and others in his league) does not automatically license the reader to make and sell proprietary designs. (I say “generally” because any given situation might turn on peculiar facts.) I suggest that you first check the fine print in the publication you are following. If it does not have a disclaimer or express permission statement of some kind, then assume the worst – the author/inventor has not abandoned their intellectual property rights. If you intend to openly market and sell your reproductions, then you might reduce risk by sending the author/inventor a letter (via certified mail) stating your inten-*

CONTINUED ON PAGE 14

ILLUSTRATION BY HAYES SHANEY

tions and inviting them to contact you if they see a problem. Otherwise, prepare for the possibility that the author/inventor will consider you a threat and come after you. Of course, if you build the reproduction furniture for personal use only, the risk is quite low. (Just for the record – Mr. Moser, if you are reading this, please call before you drop by my house for a visit. There might be a few pieces I'll need to hide.) On the other hand, if I were counseling the author/inventor, I would advise him to place a notice in his book stating which furniture pieces are proprietary, that buying the book conveys no license, and that permission to sell a reproduction furniture design must be obtained from the author.

Regarding your second question, I will assume that the antique is more than 20 years old and has no vestige of enforceable copyright or trademark elements. In that case, which would be typical of most antiques, neither the owner of the antique nor a museum displaying it can prohibit you from reproducing it.

—Jon Shackelford

### Art vs. Utility in Copyright Laws; And Who Holds the Plan Rights?

Jon Shackelford's intellectual property article was nicely written and long overdue. The question that I've heard most often from readers, though, is whether it's legal or illegal to make a production item from plans that have been published in a magazine. I couldn't connect the dots on that one, based on the article as written. I don't know how *Popular Woodworking* handles copyright issues on pieces designed by outside authors. Who keeps the rights to the design? Is it understood that, by publishing his plans, the author is undermining or relinquishing his copyright somehow? Is the reader entitled to make knockoffs for profit? As you know, nuances abound, but I would have been interested to hear Shackelford's take on these questions.

There is also a long-running dispute among some of the well-known turners regarding plagiarism of bowl designs and decorative techniques. I've never understood whether copyright protection extends to a shape or a technique, such as pyrography, especially when the innovator teaches his techniques and style sensibilities to students. James Krenov has tread on similarly shaky ground, spawning a generation of imitators.

Ellis Wallentine,  
owner of WoodCentral.com

From the magazine's point of view, once we publish plans that have been developed by our employees, we think they're fair game from which to build no matter what the purpose. In fact, we know that Vietnamese companies have copied some of our published designs and offered the results for sale.

—Christopher Schwarz, editor

To my knowledge, unless the plan designer is an employee, a magazine that prints plans for a furniture piece does not typically acquire ownership of the underlying copyright in the plans, nor in any other intellectual property rights the author may possess in the actual furniture design. The mere act of publishing discoveries does not undermine proprietary rights. If that were the case, research universities would not routinely encourage professors to publish their findings in scholarly journals.

Regarding bowl designs and decorative techniques... yours is a tricky legal question because a bowl is more than a purely artistic object – rather, it is a utilitarian object like a lamp base or a vase. In copyright law, there is a prohibition against granting copyright registrations for things that are useful (like bowls and chairs). However, purely artistic decorations on the bowl, such as an original engraving or paint scheme, would be copyrightable as a stand-alone work of art. Although the shape of a bowl is almost certainly not copyrightable, the originator could turn (pun intended) to design patent laws for protection.

When you speak of "style sensibilities" and Krenov, keep in mind also that identifiable features that are characteristic to a person or group could in theory be protected as trademarks, provided there is a continuous effort to prevent unauthorized use. Unfortunately, once those "style sensibilities" become ubiquitous, it will be too late for the originator to establish trademark rights.

—Jon Shackelford

### Clarification: 'Greene & Greene: Details and Joinery'

We omitted photo credits for two pieces in the "Greene & Greene: Details and Joinery" article in the October 2008 issue (#171). The Blacker living room armchair and the Culbertson sisters' bookcase are in the permanent collection at the Los Angeles County Museum of Art. The credit lines should have read: "Blacker armchair: Los Angeles County Museum of Art, Gift of Max Palevsky and Jodie Evans" and

"Culbertson bookcase: Los Angeles County Museum of Art, Gift of Linda and James Ries in memory of Dorothy and Harold Shrier."

To see many more pieces in the collection at LACMA visit its web site at [collections online.lacma.org](http://collections online.lacma.org).



### Correction: Colonial-era Plate Rack

In the November 2008 issue (#172), the length of the "long shelves" in Kerry Pierce's "Colonial-era Plate Rack" article are incorrect in the cutlist. The length should be 37 5/8", not 50 1/4". PW

### Question? Comment? We want to hear from you.

*Popular Woodworking* welcomes comments from readers about the magazine or woodworking in general, as well as questions on all areas of woodworking. We are more than happy to share our woodworking experience with you by answering your questions or adding some clarity to whatever aspect of the craft you are unsure about, and if you have a complaint, we want to address it whenever possible.

Though we receive a good deal of mail, we try to respond to all correspondence in a prompt manner. Published correspondence may be edited for length or style. All correspondence becomes the property of *Popular Woodworking*.

Send your questions and comments via e-mail to [popwood@fwmedia.com](mailto:popwood@fwmedia.com), or by mail to:

Letters  
Popular Woodworking  
4700 E. Galbraith Road  
Cincinnati, OH 45236

THE WINNER:

# A Hoseline Clothesline

There's nothing more annoying than a vacuum hose dragging on the bench when you're working with a router, sander or other power tool. These big hoses always seem to hang up on workpieces and tangle with tools on the bench. I finally found a cheap, easy solution in the form of a \$15 clothesline retractor available at home centers.

Attach the unit to the ceiling and pull out enough line to create the necessary tension to carry your vacuum hose. (The more line you pull out, the stronger the retraction force.) You can cut off any excess cord, but don't let go of it before you reattach the hook because the cord will zip back into the case! Now your vacuum hose will stay suspended at the proper height above you. Whether you're working down on the benchtop or working up high on a tall piece, the hose simply moves out of the way.

—Dennis Kugizaki,  
Colorado Springs, Colorado

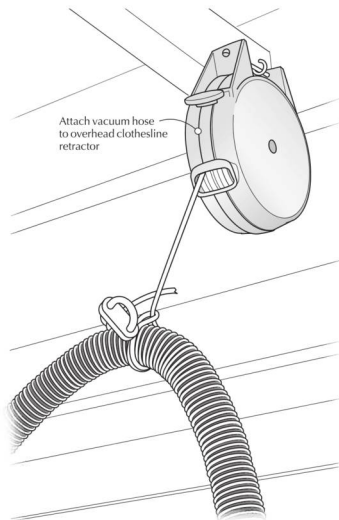

## Making Good Use of a Negative

When cutting a hardboard template to use for a router guide pattern, save the "negative" offcut. Its outline can be used as a mask to view and compose a nice grain pattern on the stock before attaching the positive section to the workpiece for machining.

—Barry Burke Jr., Middletown, Connecticut

CONTINUED ON PAGE 18

## Cash and prizes for your tricks and tips!

Each issue we publish useful woodworking tips from our readers. Next issue's winner receives a \$250 gift certificate from Lee Valley Tools, good for any item in the catalog or on the web site ([leevalley.com](http://leevalley.com)). (The tools pictured at right are for illustration only, and are not part of the prize.)

Runners-up each receive a check for \$50 to \$100. When submitting a trick (either by mail or e-mail) you must include your complete mailing address and a daytime phone number. If your trick is selected for publication, an editor will need to contact you. All entries become the property of *Popular Woodworking*. You can send your trick by e-mail to [popwoodtricks@fwmedia.com](mailto:popwoodtricks@fwmedia.com), or mail it to Tricks of the Trade, *Popular Woodworking*, 4700 E. Galbraith Road, Cincinnati, OH 45236.





## Magnetic Dust Gate Control

For my dust-collection system, I use standard metal dust gates with aluminum housings and steel blades. I always found it aggravating that adjusting the gates was a two-handed operation involving loosening and tightening thumb screws to hold the gates open or closed. Fortunately, I discovered a simple solution to the problem. It turns out that a few rare-earth magnets placed against the housing will hold a gate in any position you like while allowing you to easily slide it with one hand. I found that two 1"-diameter magnets or four 1/2"-diameter magnets do the job nicely.

— Dave Owen, Lakeland, Florida

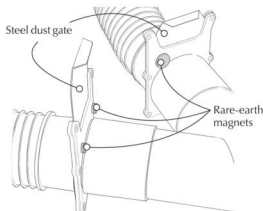

## Safe Sawing of Round Stock

Large dowels, plastic pipe or other round stock can be cut neatly and squarely on a power miter saw, but the operation can be a bit tricky. If you don't hold the stock firmly against the fence and table, and if you cut a bit too quickly, the round material can spin out of control.

One approach is to make a V-shaped cradle to hold the workpiece, but there's an easier way. I simply stick a couple pieces of self-adhesive sandpaper to the fence and table. Pressing the stock firmly against the sandpaper prevents it from spinning, making for a safe cut.

— James Wayland, Redwood City, California

CONTINUED ON PAGE 20

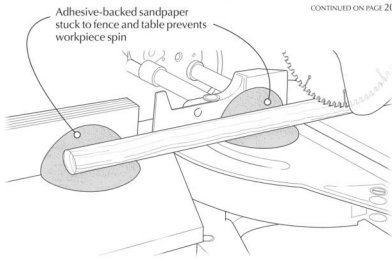

**Infinite Engraving and Cutting Possibilities for as little as \$7,995**

**Laser ENGRAVING and Cutting Guide**

Request our Laser Woodworking Guide by visiting the link below

- Create custom inlays
- Add accents to cabinets and drawer fronts
- Laser cut prototypes, jigs and templates
- Engrave personalized designs for customers

EpiLog Laser • 1.888.437.4564  
 sales@epiloglaser.com  
[www.epiloglaser.com/popwood.htm](http://www.epiloglaser.com/popwood.htm)



## A Drilling Platform for Small Pieces

Drilling small pieces on the drill press can be difficult because most clamps won't reach to the center of the table. This simple three-piece platform jig solves the problem and ensures a fast and safe setup. It consists of a small elevated panel that overhangs its support post, allowing easy clamping of small pieces. The post is centered on a base panel that extends slightly beyond the edges of my drill press table. After clamping the workpiece to the platform, I position the hole location precisely under the bit, then clamp the base to my drill press table.

The jig is easy to build as shown. To ensure accuracy, make sure the panels are strong and flat, the ends of the post are cut dead square, and that the parts are screwed together securely. I made the 2" x 4" post about 8" high, which allows use of a 3" C-clamp. **PW**

— Serge Duclos, Delson, Quebec

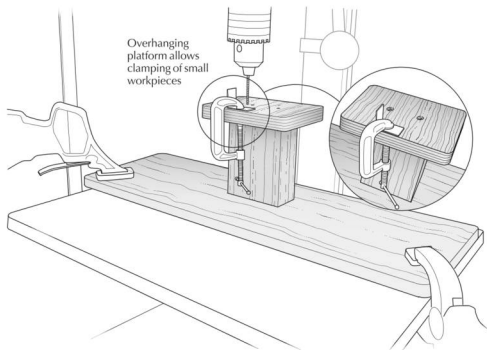

Overhanging platform allows clamping of small workpieces

## Veritas® Dovetail Saw

Combining the best characteristics of the classic fine joinery saw with those of state-of-the-art materials and construction methods, the Veritas® Dovetail Saw has a 9 1/4" long, 0.020" thick high-carbon steel blade with 14 rip-cut teeth per inch and 0.003" of set per side. The teeth have a rake angle of 14° and an included angle of 60°, providing a good balance between cutting action and surface finish. What really sets this saw apart from all others is its revolutionary spine (injection molded under high pressure using an advanced material, incorporating stainless-steel powder for weight, glass fiber for stiffness, and a polymer resin binder). The bubinga pistol grip makes the saw feel as if it's an extension of your arm.

Measures 14 1/4" long overall. Patent pending.  
**05T05.01 \$65.00** Shipping and N.Y. sales tax extra.

*To order this dovetail saw, or to request our free 300-page woodworking tools catalog, call or visit us online.*

**1-800-683-8170 [www.leevalley.com](http://www.leevalley.com)**



*Tracks straight  
for a fast,  
clean cut.*



A brass fastener secures the bubinga handle to the composite spine.



Handle nestles comfortably into the palm of the hand.

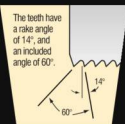

The teeth have a rake angle of 14°, and an included angle of 60°.

**Lee Valley & veritas®**

# Make a Ball & Claw Foot

Part 3 in a series on building a Philadelphia-style Chippendale chair.

If you've been following my column, you know that I am building a Philadelphia-style Chippendale chair. I've reached the stage where I'm supposed to carve the legs, and I'm just not confident that I understand the basic steps required or even the final shape. I've just not seen enough of these chairs and I lack experience carving. So I've asked for help.

Chris Storb is a conservator at the Philadelphia Museum of Art. He specializes in 18th-century Philadelphia carving. His job at the museum has allowed him to learn from one of the world's largest and most prestigious collections of Philadelphia Chippendale furniture. So he's uniquely qualified to tell us about typical characteristics, which features are unique to certain shops and what features are never apparent. For example, Storb has never seen evidence of rasp or file use on the carved feet of Philadelphia chairs (there are, however, plenty of rasp marks on other areas of chairs).

Storb is also the master carver the museum uses when a masterpiece needs work. If a recently acquired piece has a missing cartouche, Storb carves a new one. Philadelphia's American Wing actually showcases a fair bit of Storb's work.

So I was thrilled when he agreed to visit my shop and let me photograph him carving a Philadelphia-style ball and claw. It was a bit like having a free-throw lesson from former NBA star Michael Jordan.

## Laying Out the Cabriole

The ball and claw must start by laying out the cabriole leg. In my last article I prepped the leg stock at  $2\frac{1}{4}$ " square and cut the mortises. The height of the aprons is known; I've already cut those pieces at about  $3\frac{1}{2}$ ". From the bottom of the seat rail, Storb measured down to establish



**Helping hands.** Philadelphia Museum of Art conservator Chris Storb visited my shop and carved this leg using a modest set of tools and his shop-made clamp. Storb examined chairs in the museum's impressive collection to give us his sense of how these were made and precisely what they look like.

the flat spot where the knee block will attach. On Philadelphia chairs, this position (which always corresponds to the maximum protrusion of the knee) varies from  $1\frac{3}{4}$ " to  $2\frac{3}{8}$ " or so. The choice of knee-block height depends entirely on the knee carving. Notice that in the drawing, the knee block is longer than the flat where it attaches. The dimension given and association with the maximum protrusion is the flat, not the actual length of the glue block. Again, you need a carving design before this work can be done. We think that specific designs for the carvings were discussed with each individual customer. It doesn't appear that shops had "standard" carvings for customers. Consequently, it doesn't appear possible that "standard" cabriole leg templates were used for furniture with carved knees.

Some of the following pictures have a little motion blur; they were taken without interrupting the work. I thought you might see something I didn't in the way Storb held his tools, the angle of the gouges with respect to the work, etc. This made the photography a little more difficult. I think, however, it was the right thing to do.



**1** *With the dimensions from the drawing transferred to the stock, Storb quickly sawed the upper portion of the leg with a tenon saw. We didn't bother to cut mortises in this practice piece. Storb then free-handed the shape, making a smooth curve from the maximum knee width, to the ankle width, to the top knuckle. This wasn't the answer I was hoping for. The ankle height is immeasurable. The ankles are roughly straight for about 1° and roughly 4° from the floor.*



**2** *To rough out the cabriole, we tried two methods: Straight cuts with a panel saw (as shown above) and scroll cuts with a large turning saw fitted with a  $\frac{3}{8}$ " blade. Storb was accustomed to doing this work on a band saw. He found no disadvantage to the straight cuts above. A release cut, a crosscut near the ankle point, was made before the hunks were sawn out to prevent the stock from splitting. Colonial Williamsburg has discovered archeological evidence of this technique.*

**3** *The leg stock needn't be perfectly prepared. Gauged lines (shown darkened) on the end grain can be used to locate the center of the  $2\frac{3}{4}$ " stock. A  $2\frac{1}{4}$ " circle is scribed with dividers. This is the maximum ball diameter. Diagonals are then struck through the center of the circle and a  $\frac{3}{8}$ " band, indicating the width of the toe, is drawn centered on the diagonals. Last, a  $2\frac{5}{16}$ " circle is drawn indicating the intersection of the ball with the floor. We were lucky that Storb observed at least a few chairs where these layout lines were still present.*

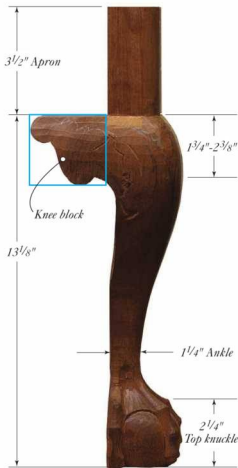

KNEE CARVING



**4** *Storb uses a shop-made clamp, modeled on one he saw at Colonial Williamsburg 20 years ago, to hold chair legs. The advantage of this clamp is that it gives him unobstructed access to the foot and doesn't rotate.*

*He begins the carving by shaping the ankle. For this sculptural work, any wide, deep gouge will do. In this picture he was using my  $\frac{7}{8}$ " #7 straight gouge. Storb used a variety of makers' tools, new and old. For the purpose of clarity I'm using the Sheffield numbering system to identify all the tools used. These cuts were made straight across the grain.*



**5** A dozen cuts later, the ankle was sufficiently roughed in. This work was so fast, it was difficult to justify sawing closer to the line.



**6** Storb roughed in the front toe and the forward edges of the side toes using a  $\frac{3}{16}$ " #11 straight gouge. These cuts can be made straight through as shown. They are brought to a depth near the outer circle.



**7** The ball begins life as a cylinder. Working on only these two quadrants, Storb shaped the cylinder with a  $\frac{5}{8}$ " #3 straight gouge. It's important to note that all of Storb's tools had a fair inner bevel (about  $10^\circ$ ) and a fairly low outer bevel (about  $15^\circ$ ). The sides of the outer bevel are ground back.

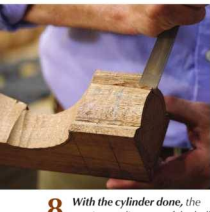

**8** With the cylinder done, the maximum diameter of the ball was penciled on at 1" above the floor. Escape cuts were made using the same  $\frac{5}{8}$ " #3 straight gouge. Storb gently rocked his gouge from side to side to the depth of the inner  $2\frac{5}{16}$ " circle. These cuts protect the toes.



**9** The lower portion of the ball was then shaped using the same  $\frac{5}{8}$ " #3 gouge. In this picture, we can actually see a single large shaving he removed by skewing the tool sideways. Storb was pushing with his right hand and pulling the tool toward himself with his left, making a fine skew cut. He worked from the middle of the ball line to the  $2\frac{5}{16}$ " scribe line on the end grain. The goal is to get a smooth spherical shape. Remember that Storb has an inner bevel on this gouge so he can ride that bevel to control the depth of cut.



**10** Storb advised making fine, light cuts, considering every cut a finish cut. Philadelphia carvers followed the "London School of Carving" approach. The gouges used to shape the carvings were typically the last tools used on those surfaces. No final smoothing, scraping or sanding was done. Gouge marks are still evident after 250 years on many of these pieces. New England furniture carvers were often smoothed or abraded to create a texture sympathetic with the casework rather than contrasting with it.



**11** With the leg inverted, the back half of the foot is marked out. The 1" line is drawn indicating the maximum diameter of the ball. A line 1" above that one (2" from the floor) indicates the top of the ball. Last, lines are drawn to indicate the projection of the toes on the maximum ball diameter.



**12** Using a  $\frac{3}{16}$ " #11 veiner, the ball is outlined. The cuts along the toes were made first. Storb pushed his veiner toward the bottom of the leg (left to right in the picture above). Then the round top was carved in a single pass. With this sort of cut, one side of the veiner is always cutting against the grain. A sharp tool and a light cut work best.



**13** Relief cuts were stabbed in around the top of the ball using a  $\frac{3}{8}$ " #5 straight gouge. This tool needs to have a sweep somewhat similar to the curve sketched on the foot. I suspect Storb was able to freehand the curve, accurately representing this tool's sweep. When I've done this, I use the tool to define the curve. Note that Storb has the workpiece cantilevered from the other end. He can't use tremendous pressure here and doesn't need to.





**14** Storb used his  $\frac{5}{8}$ " #3 straight gouge to form the rear cylinder. These cuts were made using a skewing motion, because a straight cut, with the grain, would risk splitting the workpiece. Here again, we're seeing him pull the tool toward himself with his left hand, which is steadied on the work.



**15** The rear cylinder is finished, leaving a narrow flat spot to keep track of the full diameter of the stock. The idea with the ball and claw, and all relief carving from this period, is to create the illusion of the carving floating on top of another, uninterrupted surface. In this case, the talon is gripping a ball (a pearl, actually). The portions of the ball exposed in each quadrant should seem connected with those adjacent to it. Keeping track of the center of the ball is the way this is done. Some Philadelphia chairs have small flat spots still evident in this location.



**16** The lower ball was shaped just as before. Relief cuts were made along the toes, and the ball was rounded with the  $\frac{5}{8}$ " #3 gouge. The rear talon was rounded using the same tool. The surface was also brought down a little, maybe  $\frac{3}{16}$ " or so, at the line of the top knuckle ( $2\frac{1}{4}$ " above the floor). This feature seems to change from maker to maker.



**17** The rear ankle was shaped using a  $\frac{5}{8}$ " #5 straight gouge. Cuts were made straight across the grain. Storb made no layout lines for this. In the last step, he rounded and shaped the rear talon. These cuts faired that shape up to the ankle of the leg.



**18** The rear web was finished using the  $\frac{5}{8}$ " #5 straight gouge. The shape was essentially stabbed in as before. The upper portion of the ball was also finished using the  $\frac{5}{8}$ " #3 straight gouge. Skew cuts were used where the top of the ball meets the web.



**19** Storb started shaping the lower knuckles by penciling a line  $\frac{3}{8}$ " from the bottom of the foot (floor). Using a  $\frac{5}{8}$ " #5 straight gouge, he made two light cuts with the grain from both directions to cut the scalloped shape above (bottom talon). While this tool was in his hand, he quickly knocked off the corner to form the upper knuckle. While none of this work looked careful to me, it was clear Storb left the knuckle area at the center of the ball (1" up) untouched.



**20** Storb roughed in the shape of the upper toes with the  $\frac{5}{8}$ " #3 gouge. He began rounding the upper portion of the ball at this time as well. In this picture, Storb delineated the toes with a  $\frac{5}{16}$ " #8 straight gouge. This tool created a rounded fillet between the toes and the ball. This was done mostly on the upper portion of the ball. The effect of this can be better seen in the next photos.



**21** The transition between the upper portion of the foot and the ankle is too hollow for a straight gouge. Storb used a  $\frac{3}{8}$ " #17 spoon gouge. The #17 has the sweep of a #8 straight gouge. Different manufacturers may have a different number for this tool. Some call it simply a "bent" gouge. Storb made fairly aggressive cuts with the grain.



**22** Storb continued hollowing this area with his spoon gouge until he had to work from the opposite direction to release his cuts. In this picture, you can see that he is now working parallel to the grain. This is generally a risky operation in carving because it risks splitting the wood. Lighter, more controlled cuts are necessary. Working in from both directions (from the left and from the right in the picture above) is also necessary.

The hollow shape Storb achieved here really makes this leg beautiful. It's no doubt a challenging step, and one I see often skipped on reproductions. But the result is a leg that appears much more life-like.



**23** Storb defined the web between the toes with his  $\frac{5}{8}$ " #5 gouge. He didn't draw any pencil lines. He just seemed to eyeball its location. He used the shape of the gouge to define the shape of the web. Storb began by making stabbing cuts with the gouge tangent to the toes on each side. Then he stabbed in the shape, positioning his gouge using each previous cut.

This is a basic exercise I've practiced. You stab your gouge into a piece of wood. Then place the gouge half into the cut and stab again, lengthening the arc made previously. If you are careful, you should be able to make a perfect circle. This is a technique useful for low relief carving and it was pretty clear this is something at which Storb is very proficient.



**24** Storb had previously only roughed in this shape. He now finished the upper ball using his  $\frac{5}{8}$ " #3 gouge. He skewed the tool side to side, working carefully into the cuts made in the last step. These were very gentle cuts.



**25** The toenails on Philadelphia chairs are frequently sharp and angular. They are not at all like the rounded claw we might see on a bird of prey. Storb used a  $\frac{1}{2}$ " #1 gouge, which is technically a carving gouge with no curvature, but you can just as easily use any  $\frac{1}{2}$ " chisel for this. He began with shallow stabbing cuts perpendicular to the toes. These cuts were made about  $\frac{3}{8}$ " up from the bottom of the foot.



**26** Though these only took Storb a few seconds to complete, these features can be tricky. Paring away the material on the sides requires cutting against the grain, so make sure your chisel is sharp and you make light cuts. One thing Storb has noticed on 18th-century chairs is that these toes were often held up above the floor by  $\frac{1}{16}$ " or more. The toenails ended before the bottom of the ball. This may have been done to protect toes from damage. Wear on chairs' feet has obscured this feature, which may have been very common in the period.



**27** Storb rounded the upper toes using a back-bent gouge, a  $\frac{3}{8}$ " #35 that has the sweep of a #5 straight gouge. This tool allowed him to sculpt the toes, removing their sharp corners in the hollows between and above the knuckles. Notice in the previous picture that the toes still had very square sides.

The upper web was smoothed out a bit with the help of a  $\frac{5}{16}$ " #6. I think Storb just needed a narrower gouge with a moderate sweep. So you could probably use just about anything. But you can see the nice cut that tool made along the side of the toes in the web.

## In Praise of the Typical

Because our access to period furniture is generally limited, it's difficult to know whether the features we observe on a single piece are typical. Though I'm by no means an expert on New England furniture, I believe furniture from the Newport shops of the Goddard and Townsend family is desirable precisely because it is extraordinary. I'm more interested in learning what features and construction techniques were typical of the period so that I can reassemble them to produce work that appears authentic but for which no surviving precedent exists. For this article, I asked Storb to show us typical features based on his knowledge of the period and region.

Storb is a trained sculptor. Before his visit, I wondered whether his carving approach would be like that of an artist. Would he remove little bits and pieces until the wood matched the shape in his mind's eye? Michelangelo is said to have worked front to back, in full detail, freeing the shape in his head from the marble. While I would love to have seen Michelangelo carve the "Pieta" or "David," I doubt it would affect my ability to do such work. What I observed Storb do instead was follow a series of logical steps, using a few simple dimensions. To a large extent, the process he used seemed to define this very complex shape. Each cut seemed to work the result of previous cuts. He told me every cut should have the potential to be a finished cut. Portions of surfaces he carved in the initial steps remained untouched on the finished product. **PW**

Visit Adam's blog at [artsandmysteries.com](http://artsandmysteries.com) for more discussion of traditional woodworking techniques.



**28** Here the toe at the top of the foot in the picture is just about done. The toe at bottom hasn't been rounded off yet, but you can see the gouge cuts that defined the knuckles.

## Woodturning Tools & Accessories

Free 42pg. Catalog!

- Lathes & Accessories
- Four Jaw Chucks
- Grinding Jigs
- Turning Tools & Handles
- Vacuum Chucking
- Faceplates
- Bowl Coning Systems
- Spur Centers
- Metal Spinning
- Revolving Centers



**ONEWAY**  
MANUFACTURING

1-800-565-7288  
[www.oneway.ca](http://www.oneway.ca)

CIRCLE #130 ON FREE INFORMATION CARD.

Lowest  
Prices  
Guaranteed!

# FREE CATALOG!

Your Source For  
Essential, Unique,  
& Hard To  
Find Tools!



Hartville  
Tool  
WOODWORKING

800-345-2396  
[hartvilletool.com](http://hartvilletool.com)

CIRCLE #120 ON FREE INFORMATION CARD.

## A Portable Dust Collector that Doesn't Lose Suction.

Mini-Gorilla  
Dust Collector

Extremely Quiet

Runs on 110V.  
U.S. Made  
Baldor Motor.



Made in  
the USA

Easily rolls  
into position.  
Attach the  
included 10' of  
5" flex hose and start  
collecting dust!

• Easy empty dust bin.



Oneida  
Air Systems

Call for FREE Catalog!  
1.800.732.4065

Order Online!  
[www.oneida-air.com](http://www.oneida-air.com)

CIRCLE #129 ON FREE INFORMATION CARD.

## SAND-FLEE®

Portable Drum Sander  
MADE IN U.S.A.

A New Revolution For Your Sanding Solution!



NEW! Super Compact  
Model SF-0900  
Fits Almost Anywhere!



Our NEW 9" benchtop model is  
designed for the smaller shop and  
delivers all the unique features for  
a SAND-FLEE® performance!



Add an optional flexible shaft  
detailing wand and build a  
complete SAND-FLEE®  
sanding system.



Using the easy to follow directions you  
can load the Velcro® covered drum with  
a loop backed sanding roll in minutes.  
The 18" drum easily accommodates three  
grits for quick progressive sanding.

• A Shop Proven Finishing Sander  
That Is:

- Easy • Fast • Clean • Versatile
- Cost Effective • Fun
- Made In U.S.A.

RJR Studios, LLC

609-801-1800

[www.rjrstudios.com](http://www.rjrstudios.com)

CIRCLE #135 ON FREE INFORMATION CARD.

# Throw Away Your Tape Measure

Sometimes it's best to let your project supply the answers.

**Y**ou're at work on your latest masterpiece and everything seems to be going great. After days of planning, measuring and cutting, you are finally ready to do the glue-up. Just as you start putting the pieces together, you come to the painful realization that some parts just don't fit perfectly. Maybe a stile is too short or a panel is too loose.

How could this happen? You followed the plan to the letter! But somehow, for some reason, the fit is less than optimal. Well don't despair my friends. What many folks don't realize is that there is a certain amount of error naturally built into measuring, marking and cutting. That error is something I like to call "being human." And until we can all get a bionic-eye transplant, we have to figure out ways to work around the error.

If we forget about the tape measure and let the work itself dictate the locations and relative part sizes, we are able to build with a level of confidence and accuracy that we previously thought was the stuff of dreams.

## A Path to Success

Many people start their woodworking journey by following commercial plans. Unfortunately, plans tend to reinforce the misconception that you are supposed to mill a bunch of separate parts ahead of time, and at the final step everything will come together just as planned.

The truth is, furniture parts are not mutually exclusive. At some point in the building process, it is more accurate to take your mea-



**Trash the tape.** It's not a suggestion that you go "cold turkey" on tape-measure usage. It is more a persuasion to allow the project to provide measurements to avoid a higher potential of error.

surements directly from the workpiece itself instead of relying on numbers in your plan. So instead of cutting all my parts ahead of time, I cut most of them after some physical restriction exists that dictates what those sizes are supposed to be.

A simple example would be a bookcase. If you cut all the parts ahead of time, there is a very good possibility that your shelves will either be too long or too short. The depth of the shelf dados, the width of the back panel and the thickness of the side stock are all variables that may change the actual dimensions of the shelves. So it is critical that you do a dry fit before cutting the shelf stock, and take the shelf measurement directly from the workpiece itself.

## Tools from Scraps

One of the most eye-opening moments in my woodworking career occurred when I

learned how to make and use a story stick. A story stick is nothing more than a piece of scrap wood used for marking physical "events" in a project.

Here's an example that illustrates this concept: Several years ago, I was commissioned to build a large entertainment center facade in front of a set of decorative drywall display cubbies. The challenge was accurately marking the locations of the many vertical and horizontal dividers. Of course, none of these compartments was evenly spaced and the dividers between them were all different widths.

To make matters worse, the jobsite was two hours from my shop, and I had only one opportunity to take measurements. There was no room for error.

I could have used a tape measure, but that would have been incredibly tedious. With so many measurements to take and record, I am sure I would have made a mistake somewhere.

## Online EXTRAS

To watch video of Marc's procedure to transfer and install hinges without the use of a tape measure or steel rule, go to:

[popularwoodworking.com/feb09](http://popularwoodworking.com/feb09)





**On the level.** This small story stick was used to position the shelves in this cabinet, ensuring the shelves were equally spaced.



**Quick, accurate locator.** A few shims hold the door and allow for direct transfer of the mortise centerlines from masking tape to door.



**Not in inches or feet.** Two story sticks were all it took to determine size and length, as well as position, of each piece of this entertainment center facade.

So instead, I opted for a set of story sticks made from 1/4" birch plywood.

I simply laid one of the sticks on the floor and pushed the end up against the adjoining wall. I then used a pencil to mark the start and stop points of each divider. I did the same in the vertical dimension with a second stick. In a matter of three minutes, I had an accurate representation of a relatively complex set of cubbies.

With the story sticks back in my shop, I was able to construct the facade with a level of confidence I would not have had using the tape-measure method.

A more current example of this tape measure-less system was found in my shop as I was writing this article. I was working on a small decorative cabinet featuring two simple inset doors. The mortises for the hinges were routed into the case sides earlier in the process, and the challenge was to then accurately transfer the location of those hinges to the doors.

Further complicating things was the fact that I wanted a 1/16" reveal around all sides of the door, so it was important that the hinges be placed in exactly the right positions. Of course, I could have just taken a few careful measurements, done a dance for the wood-working gods and hoped for the best. But there was a more accurate and simple, if not slightly Neanderthal, solution.

By using shims to center the door within

the case opening, I was able to directly transfer the centerline of each mortise from the case side to the door. With two simple pencil strokes, I had the marks I needed to rout the mortises in the door.

### A Path to a Perfect Fit

Another important aspect in the "Throw Away Your Tape Measure" building style is the act of cutting itself. When I first started woodworking, I thought that one day I would be good enough to make cuts consistently on a pencil mark. I soon realized that even if my cut was dead on, my mark could very well be off and the piece would not fit anyway.

So I quickly adopted a cut-to-fit methodology. That is, I find it better to cut my parts slightly oversized, and carefully nibble away the stock until the fit is perfect. It may take a few more minutes to do this, but an air-tight fit will be your reward and there is very little risk of cutting your parts too short.

Many of you may be surprised to know that you are already using techniques based on the "Throw Away Your Tape Measure" principles. Every time you use a stop block for a repeated cut, a template to make exact copies, a set of tails to mark your pins (or vice versa), or even spacers to arrange a set of drawer slides, you are exercising this concept.

Keep in mind that none of this information is The Wood Whisperer's bright idea. I am just

sharing techniques that were gleaned from more knowledgeable woodworkers with years of field experience. And believe me, we've only scratched the surface here. My hope is that this quick introduction will inspire you to think critically about how you process your project parts. Perhaps the next time you pull out that tape measure to take a critical measurement, you'll recall some of these ideas and realize that there's just might be a very simple solution that will save you time and stress – and increase your accuracy to boot! **PW**

*Marc is a professional woodworker as well as the creator and host of The Wood Whisperer ([thewoodwhisperer.com](http://thewoodwhisperer.com)). The Wood Whisperer (an instructional internet woodworking show) represents Marc's three passions: woodworking, technology and education.*

### About This Column

Our "Wood Whisperer" column features woodworking thoughts and ideas, along with shop techniques from Marc Spagnuolo. Each column has a corresponding video related to the techniques or views expressed in the column available at [popularwoodworking.com/video](http://popularwoodworking.com/video).





# Low-profile Serving Tray

Off-the-rack moulding and packing tape make this project easy.

A shopping trip to the pre-cut moulding section at Lowe's was the beginning of my tray design. I had a general idea of what I wanted to make – a shallow tray without handles to transform my ottoman into a once-in-a-while coffee table. There were extra pieces of  $\frac{1}{2}$ " plywood in the shop that would make a great tray base. All I needed was a way to cover the edges and a fancy profile to top it off. When I saw the corner moulding, I knew that the edge problem was solved. The corner moulding profile would wrap around the top and side of the plywood perfectly, providing a base for fancier trim. I found the bead, cove and steps of the glass bead moulding to my liking for the top.

## Making the Tray

Cut the tray bottom from  $\frac{1}{2}$ " Baltic birch plywood to size with a circular saw or jigsaw (a straightedge clamped in place will help guide a square cut). The finished size of the tray is  $15" \times 20"$ . The corner moulding adds  $\frac{1}{4}"$  on each side, so the bottom is cut to  $14\frac{1}{2}" \times 19\frac{1}{2}"$ .

Choose which side will be the top of the tray, and write "bottom" on the bottom side in pencil so there'll be no doubt about which side goes up.

## Mystifying Mitters

Start with the corner moulding. With the miter saw, cut the pieces about  $4"$  longer than you'll need – long sides about  $24"$ , and short sides about  $19"$ .

Fit one long side piece against the tray bottom with an inch or so extending beyond the corner, and mark the inside of the moulding at the corner. Mark the direction for the miter on the top of the moulding.

At the miter saw, set the angle at  $45^\circ$  and make the cut at one end. Hold the corner moulding tight to the fence so your miter cut



**Moulding and miters.** This combination produced an elegant tray that was fairly easy to make, and involved only two power tools.

will be accurate. To avoid tear-out when the cut is made, release the handle switch as the cut is finished but leave the blade in place until it has stopped. Repeat this step for the other long side piece.

Take the moulding piece back to the tray bottom and fit it against the corner, leaving it just a little proud, and mark the other corner location on the moulding. Also make a mark on top to indicate the direction for the miter.

Back at the miter saw, move the blade to  $45^\circ$  in the other direction, and make the cut.

Cut a miter on a piece of scrap wood, and clamp it to the fence and table (long side against the fence) with the finished side moulding in place tight against the miter. This will ensure that the next side's end cut will be exactly the same as the first. Make the miter cut on the other long side piece.

Now make the miter cut on one of the short side pieces, following the same procedure.

With a long side piece in position against the tray side and corner, fit the mitered corner together and mark the inside of the short side at the other end. Again, mark the top direction

for the miter cut. It's easy to get confused with the direction for the cut.

Make the cut at the miter saw on the other end of the short piece.

Take it back to the tray bottom and check your corners. If there's a little room for movement, that's OK. When you're satisfied with the fit, take the short piece back to the miter saw and adjust the stop to the short piece length. Make the cut to finish the second short side piece.

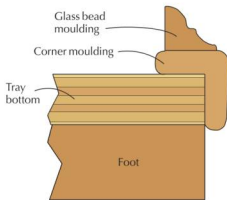

MOULDING DETAIL

CONTINUED ON PAGE 34



**Hold it right there.** Make a 45° cut in a thick scrap to use as a stop. This will hold the moulding securely as you make the miter cuts.

Now place all four sides of the moulding against the tray bottom and check the fit. Tape each corner (except one) tightly around the edge with packing tape to form the four-sided moulding frame. Then open the corners and lay the taped side down. It will be a long strip of wood with open taped joints.

Put a thin coat of glue on each of the miters and let it dry for about 10 minutes. The glue will soak into the short grain and form a slight coating. Add another thin coat of glue to the miters and press the first joint together, making sure it fits together as it should. If there's any squeeze-out, wipe it away with a wet rag.

Work your way around each joint, and when you've glued the last one, add tape to that joint as well.

Check for squareness, and when you're sure the joints are square, add another piece of tape across each corner to hold it square as it dries. Let it dry for a few hours. Remove the tape from the corners and clean up any squeeze-out on the bottom side of the frame so it will lay perfectly flat on the tray.

## Do It Again

This process is repeated for making the top moulding frame from the glass bead moulding. I chose the beaded edge to serve as the top edge, thinking that it would stand up to use better than the thinner coved edge. Again, cut

the side pieces longer than needed, and cut the miter on one end of each of the long sides.

Line up the miter of the top moulding (with the beaded edge up) with the mitered corner of the corner moulding frame. The bead will be the top edge of the tray. It's important to remember that the bead is the top when making the miter cuts. It's easy to get confident about the cuts and forget which edge is up.

With the miters matched on the cut end, shift the bead moulding until its bottom edges are centered on the frame and make a pencil mark on both edges of the uncut end of the side piece to align it with the mitered corner. This will show you where to make the miter cut.

Make the cut (remember to keep the bead side up), and clamp the stop in position for the next side piece to be cut exactly the same size as the first.

Repeat the process for the short sides.

Now dry-fit the glass bead frame on top of the corner moulding frame. Hopefully it's a good fit and close to being centered.

Take the loose frame pieces and lay them on a flat surface in position for gluing. Put a light coating of glue on the miters and let them sit for 10 minutes. Then glue the joints together at opposite corners of the frame and tape the joints to hold them in place to dry for an hour or so.

Repeat the gluing process for the other two corners when the first two are dry, forming the completed frame.

## Build Up and Glue Up

Using a #120-grit sanding block and then #180 grit, sand all the surfaces smooth. Pay close attention to the mitered corners. They should be perfectly level. Always sand with the grain direction.

Place a couple thick scraps of wood under the tray bottom to raise it up enough to allow access. Run a small bead of glue near the inside corner of the corner moulding frame and put the frame in place on the tray bottom.



**I can see clearly now.** Use clear packing tape to hold the glued mitered corners together. One piece of tape around the corner will hold the edges, then place another piece of tape underneath and pull the ends together above the joint to hold the corner in place.

Run a small bead of glue centered on the bottom of the glass bead moulding and position it on top of the corner moulding frame. Use clear packing tape to hold it in place, then use small clamps on the corners and centers of the frame edges. Make sure there are no gaps between the mouldings and the tray bottom. Clean up any glue squeeze-out with a wet rag.

When the glue is dry, remove the clamps and tape.

## Finish Up

Using 3/4"-thick scrap wood, cut four 2 1/2" squares for the tray feet. Sand them smooth and round the corners with a rasp and sandpaper.

Glue and clamp the feet to the bottom of the tray, flush with the inside moulding corners. After a final once-over with a sanding block, paint or stain the tray, and apply a coat of spray lacquer to protect the surface. **PW**

*Linda is the art director of this magazine and new to the actual work of woodworking. Contact her at 513-531-2690 x11396 or linda.watts@fswmedia.com.*

## About This Column

Our "I Can Do That" column features projects that can be completed by any woodworker with a modest (but decent) kit of tools in less than two days of shop time, and using raw materials that are available at any home center. We offer a free online manual in PDF format that explains all the tools and shows you how to perform the basic operations in a step-by-step format. You'll learn to rip with a jigsaw, crosscut with a miter saw and drill straight with the help of our manual.



Visit [ICanDoThatExtras.com](http://ICanDoThatExtras.com) to download the free manual.

## Low-profile Serving Tray

| NO. | ITEM                      | DIMENSIONS (INCHES) |        |        | MATERIAL             |
|-----|---------------------------|---------------------|--------|--------|----------------------|
|     |                           | T                   | W      | L      |                      |
| ❑ 1 | Tray bottom               | 1/2                 | 14 1/2 | 19 1/2 | Baltic birch plywood |
| ❑ 4 | Corner moulding frame     | 3/4                 | 3/4    | 24*    | Pine                 |
| ❑ 4 | Glass bead moulding frame | 1/2                 | 9/16   | 19*    | Pine                 |
| ❑ 4 | Feet                      | 3/4                 | 2 1/2  | 2 1/2  | Pine                 |

\* These measurements are longer than finished size. Cut miters to fit.

# SawStop's Contractor Saw—At Last

Safety aside, this is a solid saw on its own.

Woodworkers have been waiting for more than two years for the SawStop Contractor Saw to come to market. What's so special about this saw is the internal SawStop workings—the contact detection and braking system. That's the main focus on this saw. We've all seen the hot dog presentation.

But that's not the only thing worth talking about when you examine this saw. There are details that stand out and speak volumes of the saw as well as the company behind it.

Out of the box, this machine was far and away the easiest I've ever assembled. Each section of the assembly was color-coded and any hardware needed for that section was likewise packaged. In fact, to make this process better, SawStop included posters with clear, concise instructions. Fit and finish were near perfect and the entire build was smooth.

Our setup (#CNS175-TGP36) includes the saw, two cast iron wings and a 36" Professional "T-Glide" fence. We added the mobile base, too.

Even though the stamped wings are nice, go for the cast wings. Cast iron wings add nearly 70 pounds to the machine, and that increases vibration absorption of the saw.

If you plan to move your saw around the shop, the integral mobile base is the way to



## SawStop Contractor Saw

SawStop, LLC • 503-570-3200  
or [sawstop.com](http://sawstop.com)

CNS175-SFA30 • \$1,599

CNS175-TGP36 • \$1,779

For more information, circle #152 on Free Information Card.

go. It's smooth to operate and lifts the entire saw with ease. At \$160 the mobile base is a must-have. It is much better than an after-market base—no more toe stubbing on ill-placed wheels or braces.

Another worthwhile upgrade over the standard saw setup (#CNS175-SFA30) is the fence system. For \$180 extra, chuck the 30" extruded aluminum fence and rail in favor of the beefier 36" T-Glide system. The Biesemeyer-style fence is well worth the investment.

And we were pleased with the saw itself. The top is acceptably flat, the wings align for a nice level fit and the blade run-out is .001". Decibel (dB) readings taken at ear height as you stand in operator position were only 81 dB. (That rating is less than that of a random-orbit sander.) Additionally, vibration is all but non-existent. The age-old nickel trick—balancing a nickel on its edge during operation—stood firm throughout powering up, running and winding down of the saw.

I did find a couple things I felt could have been stronger on this saw. The handles used to operate blade tilt and height adjustments are lightweight. And the blade insert is a bit springy at the rear. As small parts are cut, there could be issues with the sagging of the insert.

Also, I'm not a fan of having to use a screwdriver to release the throat plate to gain access to the riving knife and brake-system area.

But a nice feature that pushes this contractor saw beyond most competitors is the addition of the shroud around the blade. At the bottom of the shroud is a 4" dust port that's unexpected. It increases the dust collection of the saw bringing it in line with hybrid saws. I was duly impressed.

In using this saw, I found it to have all the guts you would expect for a 1¾-horsepower saw. You'll have plenty of power for most furniture-making operations, but not the kind of power you get from a 3-hp cabinet saw.

If you're in the market for a saw that operates with a standard 110-volt household circuit, this saw competes with the hybrid models. However, the big draw with this saw is the safety factor provided by the braking system. Is that worth the higher purchase price? That's a math problem for you to solve.

—Glen D. Huey



Steel reinforced plastic. Even with a steel backing, the insert flexes a bit at the back.

## New Veritas Premium Block Planes

For those who think Veritas makes planes that work better than they look, I want you to feast your eyes on the newest block planes from this Canadian company. The new NX60 and DX60 block planes have flowing lines that resemble an Italian race car, manufacturing details that befit a Japanese operation and performance that matches any competitor.

The new planes are just the right size, shape and weight to be all-purpose block planes. Plus, they have improvements that set them apart from competitors. Most notable is a stop for the plane's mouth plate. Set this with a hex key (a one-time operation) and you'll never strike the end of your plane iron with the mouth plate again. There are also set screws (as on many Veritas planes) that help you tune the position of the iron in the mouth.

Both planes are made from a ductile iron. The more expensive (\$279) NX60 is made from a corrosion-resistant alloy that uses more nickel. Both planes use a 1 3/8"-wide A2 blade that is lapped on its unbeveled face (mean-

ing less set-up time for you). The irons are bedded at 12°. And all the knobs are extremely well-knurled stainless steel.

The Norris-style blade adjuster controls both the depth of cut and the skew of the blade in the mouth. One notable improvement Veritas has made is to the adjuster: The adjuster is locked in place to the plane's body and won't come out when you remove the iron.

In use, these planes stick firmly to the wood and are extremely stable when cutting. Both planes cut the same, but I liked holding the NX60 better. Not because it's shiny (and it is indeed a shiny thing) but because each sidewall has three grooves milled there. These look cool and make the plane easier to grip

### Veritas NX60 and VX60

Lee Valley Tools • 800-871-8158 or [leevalley.com](http://leevalley.com)

Street price • \$179 to \$279

For more information, circle #153 on Free Information Card.

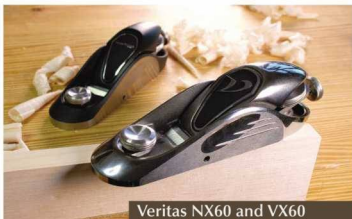

and more difficult to throw across the room when planing.

These tools are the beginning of an entirely new family of planes at Veritas. The company definitely has started out right.

—Christopher Schwarz

CONTINUED ON PAGE 40

*We have the hardware and supplies you need!*

### Functional Hardware



### Abrasives & Adhesives



### Tools



Also see:

- Locks • Lighting • Bar Roll
- Fasteners • Kitchen organizers
- Shelf brackets and much more...

Request a FREE catalog - Promotion #830

**Woodworker's Hardware**  
woodworkershardware.com  
or 1-800-383-0130

CIRCLE #148 ON FREE INFORMATION CARD.

### Walking the talk.



Hand tools for the serious woodworker

**TOOLS FOR WORKING WOOD**

800.426.4613 32 33rd St. Brooklyn, NY 11232

[www.toolsforworkingwood.com](http://www.toolsforworkingwood.com)

CIRCLE #143 ON FREE INFORMATION CARD.

### Marc Adams

**School of Woodworking**  
is committed to fine woodworking excellence through hands-on learning experiences with the best woodworkers of modern time.

Check out our new interactive brochure online at [www.marcadams.com](http://www.marcadams.com)  
317-535-4013

- Over 130 workshops that last from one day to two weeks
- More than 60 internationally recognized instructors
- Classes are hands-on in a facility that is unrivaled



CIRCLE #127 ON FREE INFORMATION CARD.

## Optimal Performance with 'AutoShift'

Drills have been the focus of many tool manufacturers for a few years now. We've had to endure comparisons of Nickel-cadmium, Nickel-metal hydride and Lithium-ion batteries. We've moved through 12-volt to as high as 24- and 36-volt batteries.

So what's next? It appears to be an examination of torque. To that end Ridgid has introduced the 18v Lithium-ion "AutoShift Drill/Driver." This new drill starts in high speed but automatically senses if additional torque is needed and if so shifts into a lower gear to finish the job. Once the task is complete, the drill shifts back to the higher speed setting. If you wish to bypass the auto-shift function, simply flip the selector and you stay in high speed throughout the work.

Why do we need this automatic shift? According to the manufacturer, this design provides peak performance and makes your work more productive. It makes your drilling and driving tasks easier and faster. And it prolongs the life of the tool and its batteries by always performing at optimal settings.

Included on the tool is a pair of lighted arrows to indicate what setting is being used. A blue arrow tells you you're in high speed. But when additional torque is needed and the drill shifts, an amber arrow illuminates. Do we need this information?

This drill is noticeably heavier than the previous Ridgid model (R86006) – nearly 10 ounces more. And the rotation-selector slide switch is difficult to operate.

This kit includes the 1/2"-sleeveless-chucked drill, a battery charger and two Li-ion batteries; one is a 3.0 amp hour (AH) battery for extended use (it recharges in 45 minutes) and the second is a smaller 1.5 AH battery that is lightweight and for hard-to-reach places (it recharges in 20 minutes).



18-volt Lithium-ion AutoShift Drill/Driver

Ridgid • 866-539-1710 or [ridgid.com](http://ridgid.com)  
Street price • \$229

For more information, circle #154 on Free Information Card.

We reviewed the drill test results from our April 2008 article (issue #168) and compared the R86006 to the new model (R86014). In the 1"-hole test, the auto-shift tool drilled 28 holes compared to the earlier model's 21 holes. **PW** —GH

### PUT A SHOPBOT BUDDY CNC TO WORK FOR YOU

The ShopBot Buddy is the ultimate workshop tool, allowing you to create a huge variety of projects and components, from simple 2D shapes to intricate relief carvings. American built and engineered, the Buddy is a professional grade CNC tool with the performance, size and price to fit your needs, space and budget.

With complete systems for less than \$6,000, the Buddy is the perfect tool for many applications, whether you need a flexible CNC machine to add to your manufacturing operation or you're looking for a way to take a hobby or small business to a new level of quality or profitability.

Buddy is available in two sizes – 24"x32" and 24"x48" - and the optional PowerSlick attachment extends the length up to 12 feet, so the system can grow as your needs change. Plus, it's fully mobile, so it's never in the way when you're not using it. The ShopBot Buddy is the perfect CNC solution for when you don't want to compromise speed, accuracy and performance for price or space.

Call or visit us online to learn how you can put Buddy to work in your shop.

888-680-4466  
[www.shopbotbuddy.com](http://www.shopbotbuddy.com)  
[www.shopbottools.com](http://www.shopbottools.com)



What will you make today?



Buddy 32



Buddy 48

CIRCLE #139 ON FREE INFORMATION CARD.

### Walking the talk.



Festool Tools & Accessories—We Stock it All!



800.426.4613 32 33rd St. Brooklyn, NY 11232 [www.toolsforworkingwood.com/festool](http://www.toolsforworkingwood.com/festool)

CIRCLE #143 ON FREE INFORMATION CARD.

### Lie-Nielsen TOOLWORKS<sup>®</sup> INC.

No. 4 Bronze Smoothing Plane

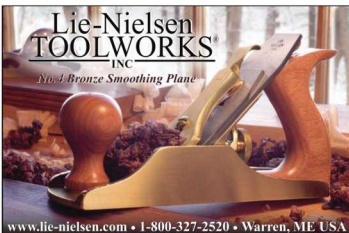

[www.lie-nielsen.com](http://www.lie-nielsen.com) • 1-800-327-2520 • Warren, ME USA

CIRCLE #124 ON FREE INFORMATION CARD.





*Hidden entertainment.* This traditional cupboard hides a flat-screen television and all the accompanying audio and video accoutrements.

A classic furniture form revised for 21st-century entertainment.

# Shaker

BY MEGAN FITZPATRICK

# Stepback



I have a love-hate relationship with my television. I love (too much, perhaps) to watch shows, but I hate having the TV out in the open as the focal point of my living room. But I also dislike most commercial entertainment centers, as I've a penchant for antique and antique-style furniture.

So, I flipped through a pile of books on Shaker furniture and auction-house catalogs to cull design ideas for a stepback cupboard that could be repurposed as a modern entertainment center that would not only allow me to hide a 32" flat-panel TV behind doors, but also house the cable box, DVD player and various stereo components. (Of course, if you want to use it in your dining room, just omit all the holes in the backboards for air flow and cord management.)

## A Plethora of Panels

While this project is quite large, it's surprisingly easy to build – though it's an exercise in organization to keep all the parts

straight. The upper face frame, lower carcass and all four doors are simple mortise-and-tenon joints, with panels floating in grooves in the doors and carcass sides.

The first step is to mill and glue up all the panels. Use your best stock for the door panels, as they'll show the most. And here's a tip I didn't know until after it was too late: Keep all your cathedrals facing in the same direction and your panels will be more pleasing to the eye.

For the four doors, you'll need six  $\frac{5}{8}$ "-thick panels, two each of three sizes. You'll also need two  $\frac{3}{8}$ "-thick panels for the lower carcass sides.

Unless you have access to a lot of wide stock, you'll also need to glue up  $\frac{3}{4}$ "-thick panels for the upper carcass sides, top, bottom and shelves, and the lower carcass bottom, shelf and top.

I glued up all my panels oversized. After the glue was dry, I took them out of the clamps, stickered them and set them aside. I cut each to its final dimension as it was needed, after calculat-

ing its exact measurement from the dry-fit frames and carcass sides. I don't trust cut lists; no matter how religiously I stick to the plan, measurements change in execution.

### Mortises and Tenons Galore

With the panels set aside, I moved on to all the pieces that would be joined with mortise-and-tenon joints. Initially, I'd planned to concentrate on one carcass at a time to more easily keep things organized. I quickly realized that's an inefficient work method, as the mortise-and-tenon setups are the same on both the top and bottom pieces of the project. Rather than create each setup twice on the machines, I prepared all my stock and cut the joints at the same time.

First, chuck a  $1/4$ " chisel and bit in the mortiser, and take the time to make sure the chisel is dead parallel to the machine's fence. I began with the leg mortises—the only pieces on which the mortises aren't centered. After

choosing the best faces for the show sides of each, mark which leg is which. Mark out your mortises. On the inside back of the rear legs, they're set in  $1$ " so the rail can accommodate the  $5/8$ "-thick backboards. On the front and sides, they're  $1/4$ " back from the show faces, so that the rails end up flush with the front of the leg faces. The top rails are flush with the top of the legs, so lay out  $1 1/2$ " mortises on the inside front of the two front legs, and  $2 1/2$ " mortises on the side,  $1/4$ " down from the top. The bottom rails are all  $3$ ", so your mortises will be  $2 1/2$ ",  $1 1/4$ " up from the bottom of the leg.

Cut the mortises for the back rail first with  $1$ " distance between the chisel and the fence, then change the setup to  $1/4$ " spacing, and cut the remaining mortises in the legs. To make clean mortise cuts, most of the *Popular Woodworking* editors use the "leap-frog method." That is, skip a space with every hole, then clean up between the holes. Some woodwork-

ers prefer to overlap each hole to get a clean cut. Try both methods on scrap pieces, and use whichever you prefer.

Assuming your stile stock is exactly  $3/4$ " thick, the setup should remain the same for the face frame and door mortises, but double check that the chisel is centered in your stock before making that first frame cut. And, make sure you always work with the same side against the fence—if you are off a little bit, you'll be equally off on every joint, and cleanup will be easier.

Lay out all the mortises on your face frame and door frames and make the cuts. (A sturdy  $6$ " rule is my preferred tool for cleaning the detritus out of the bottom of each mortise.)

Now it's on to the tenons. I prefer to set up the full  $13/16$ "-wide dado stack at the table saw, and raise it to just shy of  $1/4$ ". That way, I can make two passes on each end of my tenoned workpieces, and simply roll around each face to create the tenons, without hav-



**A sea of panels.** I wanted to glue up all the panels at the same time—but I ran out of clamps and space. Above are the six door panels and two lower side panels.



**Many mortises.** The majority of joints in this project are mortise and tenon. Take the time to set the hollow-chisel mortiser to cut dead-on centered mortises,  $1/4$ " deep—it will save you a lot of frustration and time later.



**Table-saw tenons.** The full dado stack on our table saw is  $13/16$ " and the tenons are  $1/4$ " long, so I made the first cut on each face with the workpiece tight to the fence, then slid it to the left for a second pass. The blades are raised just shy of  $1/4$ " so I was able to simply roll the end of each  $3/4$ " workpiece to cut the tenons with one setup.

ing to change the setup at all for any of my 1 1/4"-long tenons.

With the tenons cut just a hair oversized in thickness, I test-fit each one individually in its mortise and used a shoulder plane to reach the final fit. Planing a slight chamfer at the end of the tenon will help it seat. (The fit should be a tight press fit. The tenon shouldn't move around in the mortise – nor should you need a mallet to get things together.)

## Grooves for Floating Panels

With the mortise-and-tenon joints all dry-fit, it's time to cut the grooves that will accept the floating panels. Chuck a 1/4" three-wing cutter into your router table, and raise it 1/4" (you can use your already cut mortises to set the height – no measuring necessary). Set the fence to make a 3/8"-deep cut.

Start with the legs – and double check to make sure you have the faces marked correctly. The floating panels are on each side of the carcass, so a groove is needed from mortise to mortise on the front face of both back legs, and on the back face of both front legs. Unless your ear protection blocks out all noise, you should be able to hear the difference in sound as the router cutters move from the hollow of the mortise into the groove cut (mark the starting and stopping point if you're worried about recognizing the sound differential). With the leg flat to the table and the mortise toward the bottom, push the leg against the fence so that the router bit is spinning in the empty mortise hole, then move the leg across the table, cutting a groove that stops in the other mortise, then pull the leg away. Repeat until all four leg grooves are cut, and set the legs aside.



**Final fit.** I purposely cut the tenons just a hair oversized. I reached the final fit by testing each tenon in its mortise, then shaving each cheek as needed with a shoulder plane. And, I planed a slight chamfer on the tenon ends to make them easier to fit.



**A home for floating panels.** To cut 3/8"-deep grooves for the floating panels, set up a 1/4" three-wing cutter (also known as a slot cutter), using your mortises to set the cutter height. The groove will run from mortise to mortise.



**Raised panels.** Set up a fence-extension jig on the table saw, set the blade at a 12° angle, set the distance between the fence and blade at 3/16" and raise the blade until it just clears the workpiece as the cut is made. This jig, built by Senior Editor Glen D. Huey, slides along the rail, so the workpiece can be clamped in place.

Test the bit height on your 3/4" stock before proceeding. It shouldn't need adjustment ... but it never hurts to be sure. Grooves are needed on all frame pieces that will house a panel – that's the inside edges of all the door rails and stiles, and on both long edges of the medial rails for the upper doors. On the stiles, the groove goes from mortise to mortise. On the rails, in order to cut a full 3/8" deep across the rail, you'll be nipping the inside edge of the tenon. That's OK – but be careful to cut away as little as possible so that the joint retains maximum strength.

## Raised Panels

Now dry-fit the sides and doors and take the final measurements for all the panels. Add 3/8" to both the height and width of each; with 3/8" hidden in the groove on all sides, you build in an 1/8" on either side for your panel. Retrieve the door and side panels from your stickered stack; cut them to final size at the table saw.

Now, set up a fence-extension jig on your saw – a stable flat panel attached to your rip fence will work, but that jig will be stationary and you'll have to carefully move your work-

piece across the spinning blade. It's safer to make a jig that fits over the fence and slides along it. That way, you can clamp the workpiece to the jig and move the unit instead.

For any stock thickness, set the blade angle to 12°, and set the fence so there's 3/16" between the fence and the inside saw tooth as the tooth clears the bottom of the throat plate. Raise the blade enough so that the stock fits between the blade and the fence (approximately 2 3/4"). This ensures the blade will clear the stock completely as the cut is made. Make sure you use a zero-clearance throat plate; otherwise, the thin offcuts will get caught and kick back.

Cut across the grain first, at the top and bottom edges. Any tear-out will be cut away on your second two cuts, which are with the grain. Clamp your workpiece firmly to the fence extension and slide it smoothly across the blade. Now repeat until all six panels are raised, and sand away the mill marks. These panels will fit snug in the 3/8"-deep grooves, and allow for seasonal expansion and contraction. And if you prefer a more country look to a Shaker style? Face the raised panels to the outside of the piece and you're there.



## Shapely Feet

At some point before you do any glue up, you'll want to turn your feet at the lathe and create a tenon at the end to join to the leg. (Of course, you could also add 6" to your leg length, and turn the foot on the leg stock. However, I decided I'd rather muck up a 6" length of wood than a 3/4" piece, so I made the feet as separate pieces.) I first milled each foot blank square, then turned them round and shaped each foot, following the pattern at right.

Even if each foot is slightly different (you can't tell unless they're right next to one another), be careful to turn the tenoned ends as close in size as possible. To achieve this, I set my calipers to 3/4" and held them against the tenon as I cut the waste away with a wide parting tool. As soon as I reached a 3/4" diameter, the calipers slid over the piece. I then turned the rest of the tenon to match.

Why make those tenons the same? Well, you have to fit the tenons into drilled holes that are centered in the bottom of each leg, and I wanted to use but one drill bit and achieve a tight fit.

I clamped each leg perpendicular to the floor, and drilled 3/4"-diameter x 1 1/4"-deep holes centered in the bottom of each leg. Be careful to keep your drill straight (or set up a drill press for greater accuracy). With the holes drilled, I set the feet aside until the rest of the bottom carcass was done.

## Time for Glue Up

Dry-fit all your panels to the grooves inside the door frames and the bottom case sides, and make any necessary adjustments. Once everything fits snug, get your clamps ready and work with one glue-up at a time (I started with the lower doors and side panels, as they involved fewer pieces).

Use an acid brush to apply a thin layer of yellow glue on the walls of your mortises and



**Custom feet.** I shaped my 6" feet on the lathe and turned a 3/4" x 1 1/4" tenon at the top of each. While the feet needn't be identical, the tenons should be close in size. I held calipers set to 3/4" against the piece as I used a parting tool to make the cut. When I reached 3/4", the calipers slipped over the tenon and I was done.

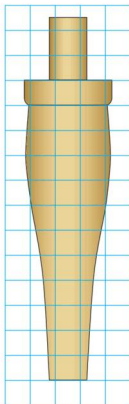

FOOT LAYOUT



**Foot holes.** Before the bottom carcass is glued up, drill holes to receive the tenons on the turned feet. I used a 3/4" Forstner bit to drill 1 1/4"-deep. Match your bit and depth to the size of the tenons on your feet.

## Supplies

### Lee Valley

800-267-8735 or [leevalley.com](http://leevalley.com)

- 4 pr. ■ 3" x 1 11/16" narrow extruded brass fixed-pin butt hinges #00D02.04, \$19.60 per pair

### Rockler

800-279-4441 or [rockler.com](http://rockler.com)

- 4 ■ 1 1/8" cherry Shaker pegs #78469, \$5.99 per pair

*Prices correct at time of publication.*

the tenon faces, slip the rails in place, then slide the panel in place and cap it off with the opposite stile (keep a damp rag handy to wipe away any squeeze-out). Clamp until the glue is dry. (Again, add glue only to the mortise-and-tenon joints; the panels should float.) The upper doors are a bit tricky to glue up, with two panels plus the medial rail in each. I'm sure my contortions were amusing to watch. I recommend getting a friend to help wrangle things in place.

While you're waiting for the lower sides

to dry, glue up the upper face frame, check it for square, clamp and set it aside. Once the lower side panels are set, complete the lower carcass's mortise-and-tenon joints by gluing the lower back rail, the front rails and the center stile in place. (The upper back rail is notched around the legs at both ends, so it's easier to use pocket screws for that joint, though you can cut a mortise-and-tenon joint if you prefer.)

Now it's on to the upper section. Cut your sides, top, bottom and shelves to final size. The



$\frac{3}{4}$ "-thick top, bottom and shelves are housed in  $\frac{1}{4}$ "-deep grooves cut into the side pieces. So set up the dado stack again at the table saw but use only enough blades and chippers to create a  $\frac{3}{4}$ "-wide cut (and be sure to run a few test pieces first). Raise the stack to  $\frac{1}{4}$ ". Mark the cuts on one of the case sides and set the fence off that piece, making the cuts in both sides before moving the fence for the next location. Make sure your cuts are on the inside faces of your sides. Note in the illustration that the top and bottom pieces are not at the ends; they're set in to add rigidity, and the bottom protrudes  $\frac{1}{4}$ " above the face-frame bottom and thus functions as a door stop.

Before you take off the dado stack, run a  $\frac{3}{4}$ "-deep x  $\frac{7}{16}$ "-wide rabbet up the back of each side; these will house the backboards.

Now lay one side piece flat on your workbench (groove-side up) and fit the top, bottom and shelves into place. Set the other side piece on top, and use a dead-blow mallet to fully seat the pieces in the grooves. (This is a big workpiece—you might want to grab a helper.) If the pieces fit together snug, you could pull them back out, add a little glue and refit them. But after struggling to get them in place once, I didn't want to go through that exercise again (and it was a lot of exercise). Instead, I chose to toenail the shelves in place from the bottom face at both the front and back edges.

At this point, I also pegged all the mortise-and-tenon joints, and pegged the shelves in the upper carcass into the sides, using  $\frac{1}{4}$ " white oak pegs (for more on pegging, see "Square Pegs, Round Holes" in the techniques section at [popularwoodworking.com](http://popularwoodworking.com)).

Now fit your doors to the face frame, and mark then cut the hinge mortises. Keep the door fit tight—you'll do the final fitting once the entire carcass is together (things could move when you add the backboards later—trust me). You might as well fit the lower doors and hinges at the same time.

Now, flip the upper carcass on its back and glue the face frame in place, adding enough clamps to pull it tight along each side. If things work out correctly, you'll have a slight overhang on both sides, which, after the glue dries, you can flush to the face frame with a trim router or handplane.

## Backboards

Is that dado stack still in your table saw? Good. Mill enough  $\frac{3}{8}$ "-thick stock for your backboards for both the top and bottom, and run  $\frac{5}{16}$ " x  $\frac{3}{8}$ " rabbets on opposing edges for

shiplaps (and don't forget to calculate the rabbets as you're measuring the width of your rough stock). The outside pieces get only one rabbet each.

I used random-width boards pulled from an old stash of sappy cherry. Because the backboards will be on view with the doors open as I watch TV, I didn't want to use a less attractive secondary wood. So I used less-attractive pieces of primary wood. With the rabbets cut, change the table saw set-up back to a rip blade, and rip the outside backboards to final width (the humidity was low here when I built this, so I used dimes as spacers).

Screw the backboards in place, with one screw at the top and bottom of every board set just off the overlapping edge. (That screw holds the joint tight, but allows for slight movement of the underlapped piece. Your last board needs two screws at the top and bottom to keep it secure.) Now do the final fit on your doors, taking passes with a handplane or on the jointer (take a  $1^\circ$  cut on the trailing end first, then reverse the piece to avoid tear-out). I aimed for a  $\frac{1}{16}$ " gap all around (on some sides, I even hit it). After marking locations for any necessary wire and air-circulation holes in the backboards, take the doors and backboards off, drill any needed holes at the drill press, then set the doors and backboards aside for finishing. Drill any cord/air holes at the drill press with a Forstner bit.

## Complete the Bottom

Flip the lower carcass and choose your foot position. Line up the grain of the foot with its matching leg so the look is pleasing. One of my holes was a bit off straight, so I used a rasp to

## Online EXTRAS

For additional information on cutting cove moulding at the table saw, watch Senior Editor Glen D. Huey's video at [popularwoodworking.com/videos](http://popularwoodworking.com/videos), under techniques. For additional information on pegging, see "Square Pegs, Round Holes" in the techniques section at [popularwoodworking.com](http://popularwoodworking.com). And for information on adding age to hinges, see Editor Christopher Schwarz's blog entry linked from [popularwoodworking.com/feb09](http://popularwoodworking.com/feb09).

take down one side of my tenon until I could adjust the angle accordingly. Once everything fits to your satisfaction, drip a little yellow glue in the holes and seat the feet. You don't need clamps here (unless you're using them to pull something in line). If the fits are good, simply flip the piece upright and the weight will keep the feet in place as the glue dries.

With the backboards and doors off, now's the time to fit the cleats that support the bottom and shelf in the lower section, and cut button slots in the top rail to attach the top. The bottom is notched around the legs and the back edge is rabbeted to fit neatly over the back rail. But because I need airflow in the bottom section for A/V equipment, I fit the shelf to the inside corner of each leg and to the front center stile where it serves as a door stop. I left a gap at the back and sides to run wires and for air circulation.

To complete the bottom section, use a biscuit cutter to cut slots in the front and side rails for buttons, and notch the upper back rail around the rear legs and use pocket screws to hold it in place. For added strength,



### Buttressed down.

The top of the bottom section is attached to the side and front rails with buttons. I used a biscuit joiner to cut two  $\frac{1}{2}$ "-deep x  $\frac{1}{4}$ "-wide slots on each side, and three along the front. I simply screwed through the back rail into the top's bottom to secure it at the back.

countersink a screw through the front edge at each end into the leg, too. Cut the top to final size, and attach it with buttons at the front and sides. Countersink screws underneath through the back rail into the bottom of the lower section.

### The Crowning Touches

Set up your table saw to cut crown moulding, and sand it smooth before fitting. (For instruction on cutting cove moulding on the table saw, see Senior Editor Glen D. Huey's video under the techniques section at [popularwoodworking.com/video](http://popularwoodworking.com/video)).

Often, the crown is connected with a flat piece to the top edge of the sides and face



**Cutting crown.** The crown is cut by running  $\frac{7}{8}$ " x 4" stock at an angle over the table saw. Raise the blade to  $\frac{7}{16}$ " then center your stock to the blade. Clamp a long straightedge to the table to guide the stock, then lower the blade and make a series of passes as you gradually raise the blade until you reach  $\frac{7}{16}$ " (or your desired depth).

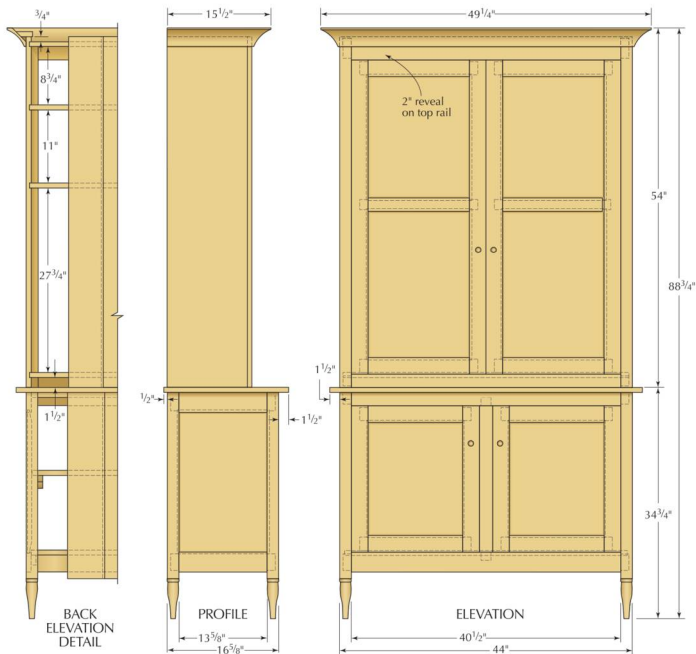

frame. But my face frame and sides weren't high enough, so instead, I cut blocks with 45° angles (on two faces for the corner pieces), glued those to the inside of the crown and added brads to the top of the carcass for a bit of additional strength.

## The Finish

I sanded each piece to #180 as I went along, so once the construction was complete, I was ready for the finish. Because I didn't have two decades to wait for a nice warm patina to develop (we shot the opening picture just 20 minutes after the handles were in place), I added warmth with two sprayed coats of amber shellac and a top coat of dull-rubbed-effect, pre-catalyzed lacquer.

Because I couldn't afford five sets of hand-forged iron hinges but wanted an aged look to the hardware, I de-lacquered then added patina to brass hinges with gun bluing.

Oh yes—the handles. I tried to turn them, but ran out of time and talent. Thank goodness for our local woodworking store and its Shaker pull supply. The handles were sprayed separately, set in a scrap of plywood. You see, I didn't know where I wanted to place them until the entire piece was assembled and the A/V components were in place. A friend helped me hoist the upper piece atop the lower cabinet, where it's held in place simply by gravity. I then marked my pull locations, drilled 3/8" holes with a Forstner bit and glued the pulls in place. **PW**

Megan is managing editor of Popular Woodworking and Woodworking Magazine. She can be reached at 513-531-2690 x11348 or megan.fitzpatrick@fswmedia.com.

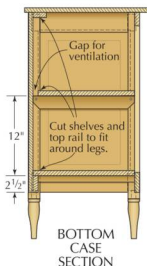

**Blocked in place.** I intended for the top of the carcass to match the top of the crown, so I could attach the crown with a piece that tied into both. That didn't happen. So instead, I cut blocks with a 45° angle on the front, and glued them to the top of the carcass and the inside face of the crown — one at each front and back corner and three more along the front. You can also see the shiplapped back in this picture. Each piece is secured top and bottom at the corner by a screw.

## Shaker Stepback

| NO.                  | ITEM                  | DIMENSIONS (INCHES) |        |        | MATERIAL | COMMENTS            |
|----------------------|-----------------------|---------------------|--------|--------|----------|---------------------|
|                      |                       | T                   | W      | L      |          |                     |
| <b>Upper Section</b> |                       |                     |        |        |          |                     |
| □ 2                  | Face frame stiles     | 3/4                 | 1 3/4  | 52 3/4 | Cherry   |                     |
| □ 1                  | Upper face frame rail | 3/4                 | 3 1/2  | 43     | Cherry   | TBE*                |
| □ 1                  | Lower face frame rail | 3/4                 | 2      | 43     | Cherry   | TBE*                |
| □ 2                  | Side panels           | 3/4                 | 12     | 52 3/4 | Cherry   |                     |
| □ 1                  | Top                   | 3/4                 | 11 3/8 | 43     | Cherry   |                     |
| □ 1                  | Bottom                | 3/4                 | 11 3/8 | 43     | Cherry   |                     |
| □ 2                  | Shelves               | 3/4                 | 11 3/8 | 43     | Cherry   |                     |
| □ 4                  | Door stiles           | 3/4                 | 2 1/2  | 47 1/4 | Cherry   |                     |
| □ 2                  | Door top rails        | 3/4                 | 2 1/2  | 17 3/4 | Cherry   | TBE*                |
| □ 2                  | Door center rails     | 3/4                 | 2      | 17 3/4 | Cherry   | TBE*                |
| □ 2                  | Door bottom rails     | 3/4                 | 2 1/2  | 17 3/4 | Cherry   | TBE*                |
| □ 2                  | Upper door panels     | 5/8                 | 15 7/8 | 17 3/4 | Cherry   |                     |
| □ 2                  | Lower door panels     | 5/8                 | 15 7/8 | 22 3/4 | Cherry   |                     |
| □ 1                  | Front crown           | 7/8                 | 4      | 49 1/2 | Cherry   | Trim to fit         |
| □ 2                  | Side crown            | 7/8                 | 4      | 15 3/4 | Cherry   | Trim to fit         |
| □ Varies             | Backboards            | 5/8                 | varies | 52 3/4 | Cherry   |                     |
| <b>Lower Section</b> |                       |                     |        |        |          |                     |
| □ 4                  | Feet                  | 1 3/4               | 1 3/4  | 7 1/4  | Cherry   | 1 1/4" dowel at top |
| □ 4                  | Legs                  | 1 3/4               | 1 3/4  | 28     | Cherry   |                     |
| □ 2                  | Side panels           | 5/8                 | 13 7/8 | 21 3/8 | Cherry   |                     |
| □ 4                  | Side rails            | 3/4                 | 3      | 15 3/4 | Cherry   | TBE*                |
| □ 1                  | Upper front rail      | 3/4                 | 2      | 43     | Cherry   | TBE*                |
| □ 1                  | Lower front rail      | 3/4                 | 3      | 43     | Cherry   | TBE*                |
| □ 1                  | Upper back rail       | 3/4                 | 2      | 42 1/2 | Poplar   |                     |
| □ 1                  | Lower back rail       | 3/4                 | 2 1/2  | 43     | Poplar   | TBE*                |
| □ 1                  | Center stile          | 3/4                 | 2      | 24 1/2 | Cherry   | TBE*                |
| □ 2                  | Door panels           | 5/8                 | 14 7/8 | 17 5/8 | Cherry   |                     |
| □ 4                  | Door stiles           | 3/4                 | 2 1/2  | 22     | Cherry   |                     |
| □ 4                  | Door rails            | 3/4                 | 2 1/2  | 16 3/4 | Cherry   | TBE*                |
| □ 2                  | Middle shelf cleats   | 3/4                 | 15 1/2 | 2      | Cherry   |                     |
| □ 2                  | Bottom shelf cleats   | 3/4                 | 14 1/2 | 1      | Cherry   |                     |
| □ 1                  | Top                   | 3/4                 | 18 3/4 | 47     | Cherry   |                     |
| □ 1                  | Shelf                 | 3/4                 | 14 1/2 | 42 1/2 | Cherry   |                     |
| □ 1                  | Bottom                | 3/4                 | 15 1/4 | 42 1/2 | Cherry   |                     |
| □ Varies             | Backboards            | 5/8                 | random | 27     | Cherry   |                     |

\* TBE=Tenon both ends, 1 1/4"

# *the art of making* dovetailed drawers

BY MARIO RODRIGUEZ



## Fine furniture calls for an elegant drawer. A master cabinetmaker shares his approach to design and fitting.

**T**here are just a few things my partner at Philadelphia Furniture Workshops, Alan Turner, and I don't see eye-to-eye on. But how to make a good drawer isn't one of them. When building furniture, we probably spend

as much time making the drawers as we do making the piece itself. But this is an aspect of furniture-making many woodworkers don't devote enough attention to. In this article, I'll explain and illustrate how I built a pair of drawers for a small writing desk.

Drawers bestow even the finest hand-crafted furniture with a utilitarian character by arranging, storing and providing access to objects. Yet it's important that their number, size and placement contribute to the purpose and appearance of a piece, not detract from it.

Drawers are expected to operate easily, without sticking or rattling around. Drawer bottoms shouldn't sag or be left rough-sawn, and joints shouldn't be sloppy. Drawers shouldn't be an afterthought, disappointing the viewer and diminishing the experience.

When open, a drawer should reveal craftsmanship and quality consistent with the rest of the piece. You wouldn't go to the trouble of reproducing a Philadelphia highboy, then fit its drawers with metal slides.

### Features of a First-class Drawer

No matter what type of drawers you build, there are several essentials to good drawer making:

- Good design. Drawers should be consistent with the piece being built.
- Good material. Use the best that can be obtained; whether it's solid or plywood.
- Careful measurements. Your measurements must be exact; measure carefully, then double-check the figures.
- Good, sound techniques. Basic skills on machines and with hand tools will produce crisp, clean work.

*Smarter than your average drawer.* The features that set this type of drawer apart from the rest of the pack include thin sides with slips to support the bottom, and guides and stop blocks to control movement.



**Details make the difference.** The drawers ride on the rails of the web frame, and the guides restrain movement from side to side.

■ Patience. Take it easy; making and fitting a drawer will take time and may test your patience.

These drawers are supported by and ride upon a web frame consisting of two latitudinal rails (front and rear) and three longitudinal rails (two side, one center). Drawer guides were attached to the web to track the drawers into the openings at the front of the desk. When initially installed, each guide intrudes slightly into the drawer opening by  $1/16$ ". Later, the guides are carefully planed to allow the drawers easy and smooth travel.

The height of this desk is  $29$ " below the top. I allowed  $24\frac{1}{2}$ " leg clearance, giving me  $4\frac{1}{2}$ " for top and bottom rails, and my drawers. The combined thickness of the rails is  $1\frac{1}{2}$ ", so I had  $3$ " for the drawers. That is a good height for most objects stored in a typical desk. These drawers will be almost  $14$ " wide and  $18$ " deep, which is also a good size. A drawer that is deeper than it is wide will operate easily without racking or sticking.

### Selecting Material

For the drawer fronts select clean, well-behaved material—something mild and easy to plane. For this desk, I selected a single piece of mahogany, long enough for both drawer





fronts and the center dividing strip between the drawers, then milled it to  $\frac{3}{4}$ " thickness.

For the drawer sides carefully choose your stock. Quartersawn stock is ideal; it's stable, won't twist or warp, and is easy to plane. I carefully went through a stack of maple boards, and selected the ones with the cleanest, straightest grain. Maple is a tight-grained hard-wearing wood, ideal for drawer sides. Mahogany or oak are other good choices.

Many woodworkers make the mistake of using material that is too thick, which produces heavy, clunky drawers. This is a small desk and the drawers will hold small, lightweight objects and supplies, so milling the sides to thin dimensions maintained the delicate nature and scale of the piece. You should proportion your drawer stock to the piece. For instance, drawer stock for an 18th-century spice box or a contemporary jewelry box might be as thin as  $\frac{1}{8}$ ".

Hardwood isn't usually commercially available in less than 1" thickness, so I re-saw my stock. This often means interior surfaces of the wood with different moisture content than the exterior will be exposed, which can cause some movement. If you resaw, anticipate some slight twisting or cupping, so mill extra stock and select the best for your drawers.

### Milling and Joining the Parts

After a preliminary milling, sticker the stock while you work on the rest of the project to help it acclimate to the shop environment. Then, as you approach your drawer-making, take the boards down to their finished thickness.

Rip the sides  $\frac{1}{32}$ " narrower than the opening and leave them about 1" longer than necessary in case you need to re-cut the dovetails. And, if possible, orient the grain direction to make it easier to plane and fit the completed drawer later.

Drawer fronts should be ripped and cut to fit precisely into their openings, with barely a hairline gap all around. You should try for a tight, close fit at this stage. When fitting the completed drawer boxes, the drawer front can always be planed to achieve the desired fit and appearance.

Dovetails are regarded as the strongest and most attractive way to join two perpendicular pieces of wood with the grain running the same direction. I like to use half-blind dovetails to join the drawer sides to the fronts and through-dovetails for the side-to-back joints. They have a distinctive and attractive appearance. They also provide the added benefit of squaring the drawer during glue-up, often eliminating the need for clamps.

To lay out your dovetails, follow the 1:8 rule or just lay them out at 10°, with half tails at each end and two full tails centered on the remaining space. I first make a sheet-metal



**Let it rest.** If you resaw thicker boards for drawer material, sticker them and let them sit for several days to acclimate before milling the stock to final dimensions.



**A fitting start.** Fitting the width of the drawer side to the height of the opening before building the drawer gives more control of the process.



**Proud sides.** Cutting the dovetails to leave the sides extended from the drawer front simplifies fitting and maintains the smallest possible gap between the drawer and carcass.



**Wasting away.** With thin drawer stock a jeweler's saw or coping saw will remove the waste between tails quickly and without the risk of damaging the work by chopping between the tails with a chisel.

template that gives me a clear pattern (that can be reused) to mark onto the drawer sides.

After marking the tails on the drawer sides, scribe the dovetail baseline onto the ends of the drawer front about  $1/4"$  from the face. This amount makes for a good appearance and a strong joint. On the interior surface of the drawer front, scribe a line about  $1/32"$  less than the thickness of the drawer side. That way, when the drawer box is assembled, the drawer side will sit proud of the drawer front, which allows the side to be planed flush with the end of the drawer face, without altering the size of the carefully fitted drawer front. This also makes glue-up easier because you won't have to worry about damaging the delicate pins.

When cutting your tails first, you can cut directly to the line, remove the waste at the baseline and not fiddle with lots of tedious clean up. If the saw drifts a little, that's OK—as long as the kerf is narrow, clean and straight. Any deviation from the scribed outline can be transferred over to the pin board. Remember: Half-blind dovetails are only seen from one side, so the parts can be undercut and relieved to ease the fit without compromising the appearance or strength of the joint.

Next, carefully mark the outline of the tails onto the pin board (drawer front). Cut the pins fat and pare them just shy of the line. The wide spaces between the pins will provide easy access from two angles. A partial test fit will reveal any excess material that has to be removed. I always say that folks won't notice a small discrepancy in spacing or angle in your dovetails—they'll only notice the gaps!

After fitting the drawer fronts to the sides and checking the dovetails for fit and appearance, cut a groove between the pins along the inside of the drawer fronts to accept the drawer bottoms. The placement of this groove is important for two reasons. First, it should be hidden when the drawer is assembled. Second, it should be situated to maximize your storage space.

### Thin Sides Call for Slips

If you mill your sides to a thin dimension, you should consider using drawer slips for reinforcement and extra strength. Thin drawer sides might not be thick enough to support the drawer bottom, which is commonly held in place with a groove cut into the sides.

Drawer slips are small mouldings, placed along the interior of the drawer sides to prevent their splitting under a load or heavy use. They also add character and detail.

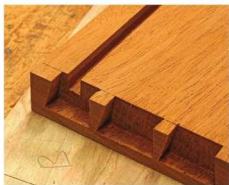

**In the groove.** The slot for the drawer bottom is located in the space for the lowest tail in the drawer front.

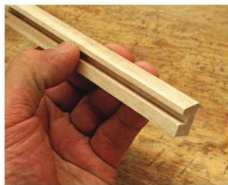

**Smooth transition.** The angled top of the slip bridges the corner between the sides of the drawer and the bottom.

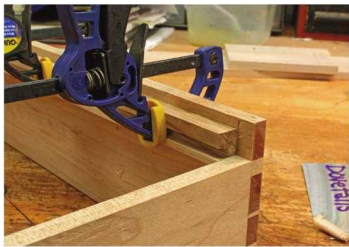

### Slip sliding away.

Glued in place, the slip strengthens the lower portion of the drawer bottom. The back of the drawer is narrower than the side so that the drawer bottom can be slid into place after finishing.

I cut the slips on the table saw with a careful sequence of cuts that yielded the slender parts. I milled them to a profile that was adequate to support the drawer bottom, yet would only minimally intrude upon the usable space of the drawer.

The sides and back of the drawer are joined with through-dovetails. These can be a little tricky because thin stock will dictate small dovetails. And if the stock is very thin, it can split when you cut the joint. However, one small advantage is they won't be seen unless the drawer is fully withdrawn.

Before laying out the joint, measure the location of the drawer-bottom groove (from the drawer front) and cut enough material off the drawer back to allow the drawer bottom to be slipped underneath it when the drawers are assembled. Don't forget to cut off the excess length of the drawer sides. My sides-to-front dovetails turned out good enough that I didn't need a second chance at them.

After cutting the through-dovetails for the side-to-back joints, dry-fitting the drawer boxes, checking dimensions and sanding the parts, I glued them up. If the dovetails are well executed, the drawers should come

together without clamps. However, if you do need clamps, check the drawers for square. You should also check for flat by placing them on a flat surface. A twisted drawer will severely complicate the installation later.

When gluing up, keep a damp rag nearby. It's a lot easier to remove excess glue from the inside of the drawer at glue-up than to allow it to dry and have to chisel it out later.

When the glue in the drawer boxes is dry, measure and cut the drawer slips to fit against the inside of the drawer front and back. Then align the slips with the groove on the drawer front and the bottom of the drawer back; glue and clamp them in place.

When appropriate, use solid wood for the bottoms. For this desk, I cut a couple of  $3/16"$ -thickness leaves from a 1"-thick piece and bookmatched them. After gluing up the panels, sand them to fair the seam and smooth the surface.

Taking the bottoms down to  $3/16"$  kept them thick enough while making them lightweight, too. After cutting them to size, I rabbeted three edges. By rabbeting the edges I could slip them into a  $3/16"$  groove, yet maintain their  $3/16"$  thickness.

Because the drawers were narrow, I oriented the grain front-to-back, because I wasn't concerned with any significant wood movement. This means that grain shrinkage or swelling will take place across the drawer. When making your drawer bottoms and orienting the grain, take the size of the drawer into account. Generally, you want to run the grain in the direction of the longest dimension. So, a drawer that measures 16" deep and 24" wide would have the grain running side to side.

### Fits Like a Glove

On a cabinet, I would remove the back before fitting the drawers. This provides easier access and the opportunity to "eyeball" any problems not visible from the outside. In this case, I left the top off the desk.

When the drawers are ready, plane the sides flush with the front; be careful not to reduce the size of the drawer front. I plane a little more off the back end of a drawer, making the back slightly narrower than the front. This allows the drawer to initially enter the cavity with ease

and tighten up slightly as it hits home.

I attempted to slide the drawer into its recess. But it was still too large to clear the opening. A few careful passes with a plane over the drawer sides fixed that. However, the box still wouldn't slide fully into the desk. With a sharp block plane, I took light shavings from the drawer guides (which were glued to the drawer web and flanked the opening) on each side. The guides are rabbeted and stop 2" short of the back apron, so their full length can be easily trimmed with a block plane. With several light, careful strokes, the drawers were planed to a tight fit.

Now the opening can be adjusted more precisely. By carefully planing the sides of the drawers I was able to achieve a tight  $1/32$ " gap all around the drawer front. But with the drawer resting on the frame, there was no reveal/gap along the bottom. This is one of the last steps in fitting a drawer and should be performed in a slow and careful manner.

To create an even gap, I scribe a line with a marking gauge and, using a tiny rabbet plane, I cut a small rabbet along the bottom edge of

the drawer front. On a larger drawer, I'd use my shoulder plane.

Once the drawers are fitted, you can apply a small amount of wax to the bottom edges of the drawer sides and the guides. When you're satisfied with the operation of the drawers and their alignment with and to the front of the desk, you can set the drawer stops in place. These are three small blocks that are glued and clamped onto the front rail of the drawer web, just behind the drawer fronts.

Some woodworkers choose to leave the drawer interiors unfinished; others finish them exactly as the rest of the piece. It's a good idea to provide some form of protection. I recommend a light coat of shellac, lacquer or just wax. I finished these drawers with a very light coat of sprayed-on satin lacquer, rubbed out and waxed. **PW**

---

*Mario has been a woodworker, teacher and author for more than 30 years. He currently teaches at the Philadelphia Furniture Workshop. Detailed information about the school's classes is available online at [philadelphiafurnitureworkshop.com](http://philadelphiafurnitureworkshop.com).*



**Match the groove.** The rabbet in the drawer bottom matches the width of the grooves in the drawer sides and front. The extra thickness in the bottom keeps it from sagging.



**Rabbeted reveal.** A small rabbet on the underside of the drawer front provides an even reveal to match the gaps at the top and sides.



**Short and sweet.** The drawer guides have a rabbet on the bottom and stop short of the back. This allows them to be planed during the fitting process.



**Stop right there.** Assembling and fitting the drawer before installing the drawer bottom allows precise placement of stops glued to the lower rail.



# FOUR WAYS TO MAKE

# TAPERED LEGS

BY KEITH NEER, GLEN D. HUEY, ROBERT W. LANG & CHRISTOPHER SCHWARZ

We explore methods to help you find the one that works best.

It's true! From working with hand tools, to powering up stationary machinery, to any combination of these two woodworking disciplines, there are myriad techniques to taper legs.

Tapering work is often completed using a band saw or table saw. At times you'll see tapered legs being made at a jointer. And some woodworkers shape their legs using a thickness planer.

On a recent visit with Keith Neer, an Ohio craftsman and woodworking teacher, we settled around a table for lunch. As you might expect, when four woodworkers get together, the conversation quickly turns to woodworking. We agreed on most topics until, that is, we touched upon tapering legs. It soon became clear that

we differed in our preferred technique. Each of us uses a different method to produce a leg design found on Federal, Shaker and country furniture.

Of the four techniques, one is completed using a single machine (after properly marking the legs). Another requires accurate layout on all legs before a two-step milling process completes the work. And two of the techniques require a custom-built jig that's used to produce any number of matching legs. One layout, repeatable results.

This is how it is for most woodworking techniques – many avenues lead to the same address. Try each of these techniques to find the one that best fits your tooling, experience and abilities.



# PLANER

As evidenced by this article, there are multiple ways to taper a leg. And over the years I've safely used each of the methods described. Several years ago, however, while teaching new woodworkers how to taper legs it became apparent that a foolproof and totally safe method was necessary. To that end, I developed the following method that uses a thickness planer and a jig.

Start by selecting a piece of 2x4 dimensional lumber that is about 6" longer than the leg you are going to taper. Flatten the face of the 2x4 using your jointer. Then with the newly flattened surface set against the jointer fence, joint one edge "square" to the face of the board.

Next, go to your thickness planer, stand the 2x4 on its square edge, and plane the unjointed edge until you are removing wood over the entire length of the piece – the final dimensions of the jig are not important.

Once you have completed the jig, do not adjust the planer settings. Now, move on to the leg stock. Follow the steps below to turn that 2x4 into a tapering jig. —KN



**1 Leg layout.** Once the leg stock is milled to final size, on one of the legs you intend to taper, mark around the leg where you want to start the taper. On the bottom of the leg, mark the maximum depth of cut required to achieve the desired taper.



**2 Marking the jig blank.** Now lay the leg on the jig so that both the line indicating the start of the taper and the maximum cut line are flush with the edge of the jig. With the leg held in position, trace around the entire perimeter with a pencil.



**3 Sawing your pocket.** At your band saw, carefully cut along the line you just drew and discard the resulting piece of wood. You should have created a "pocket" in your jig into which you can place the leg. Before leaving the band saw, remove about 1/4" of width from the top of the jig that holds the non-tapered end of the leg. This will keep the jig from "grabbing" when later feeding the leg into the planer.



**4 Roughing a taper.** Place the leg to be tapered in the jig so the bottom of the leg protrudes and the top end is "buried" in the jig. With the band saw set at about 1/16" wider than the jig, and starting on the bottom end of the leg, hog off most of the wood to be removed.



**5 Two passes for two tapers.** For tapering on the second side, rotate the leg then make another pass at the band saw.



**6 Smoothed and completed.** Finally, take the rough-cut leg (fit into the jig) back to the planer. Run the unit through the machine starting with the top of the leg. The feed rollers of the planer will safely keep the leg in the jig. If you left the height adjustment set when creating the jig, and you accurately cut the "pocket" in the jig, the taper will start precisely where the leg exits the top of the jig, and the taper will be exactly what you intended. As with the roughing-out process, for the second side to be tapered, simply rotate the leg and run the unit through the planer a second time.



# JOINTER

When this technique was first shown to me, my eyes became as wide as saucers and as bright as a supernova. I couldn't believe this method actually worked – not to mention it's easily repeatable and consistent.

Now whenever I demonstrate this technique to others, I'm delighted to see their eyes grow wide and bright as well.

You may think I'm about to describe a standard, well-known method that has you

make numerous passes over the jointer knives until you've achieved the needed taper, counting the passes as you go so the steps can be repeated on other legs. (I've seen this process recently touted in other magazines.) It's not.

This entire operation is completed with a single setup at the jointer and in two passes. Yes, precise jointer setup and accurate layout on the leg stock is necessary to match your desired profile. But once set, the method pro-

duces any number of matching legs as long as you hit the marks.

Now, this is how I create my tapered legs for any project. —GH



**1** *Half the total taper.* The most important mark on the leg stock is a line drawn at half the total length of taper – measured from the bottom of the leg upward. Square that line around the leg on all four faces and mark an "X" on the two adjoining faces that you wish to taper.



**2** *Precise setup required.* In order to create an exact taper, your jointer has to be set up properly. The cut required is going to be more aggressive than you normally make with your jointer, but it's OK and possible. Set the depth of cut to one-half the total amount of taper. (In our example, we're tapering a  $1\frac{3}{8}$ " leg to  $\frac{3}{8}$ " at the bottom, or removing  $1$ " of waste. Therefore, the depth of cut set at the jointer is one-half that amount, or  $\frac{1}{2}$ ".) Check your setup on a scrap to confirm.



**3** *Find the cut.* For consistent results, it's crucial to find the exact point where the knives begin to cut. With the machine unplugged, set a square to the knives and on the infeed table. Slowly rotate the cutterhead toward the square, pushing the tool back, until the square stops moving. At that point, mark the jointer fence and extend a line up the fence face.



**4** *Step one.* Start the first cut at the bottom of the leg. Place one "X"-marked face flat to the jointer bed and slowly push the stock into the knives until the layout line on your leg touches the line marked on the jointer fence. Carefully remove the leg from the jointer. (You can also set up a stop block to control this cut.) To cut the second face, rotate the leg  $90^\circ$  and pass the leg over the knives again. Complete step one on all leg blanks. Note: The guard has been removed for clarity.



**5** *Step two.* Flip the leg "end for end" so the top of each leg points toward the knives and one of the two cut faces is flat to the bed. Apply pressure to the cut end to make the leg "wheelie" up at the top end. (It's important to maintain this pressure along the entire length of cut.) Make one continuous pass over the knives to remove the balance of your waste material. As you complete this pass, you're making two small tapered cuts. The first begins at the top of the full-length taper and takes a  $\frac{1}{2}$ " cut at the termination of step one. The second small taper begins at that same point and continues through the bottom end of the leg. Rotate the leg to make another pass over the knives and the tapered leg is finished.

# TABLE SAW

My approach to cutting tapers comes from my history as a production woodworker. I tend to think of ways to make multiples of parts, not just a few. There is an advantage to this method, even if you are only making four legs for one table: Only one leg needs to be laid out, and the actual line of the taper doesn't need to be drawn at all.

On the bottom end of the leg, draw lines indicating the small square that will remain after the taper has been cut. From the top end of the leg, measure down and draw a square line at the point where the taper starts. Now you can put your square, ruler and straight-edge away, as this is all the layout work you need to do.

At the table saw, set your fence and rip a piece of  $\frac{3}{4}$ " MDF to width. The edge of the plywood is a reference for the exact location of the saw blade. Place the marked leg

blank on top of the plywood, with the layout marks on the leg aligned to the left edge of the plywood. I put the narrow end of the leg on the leading end of the plywood so that there is room on the trailing end for a hold-down clamp. If the leg moves, you'll be able to see it and move it back to the line as you place the blocks that secure the leg.

Use a countersink bit to drill holes for the stop blocks. It is possible to just run the screws in without drilling, but that makes it much more likely for the block to shift as the screw is driven home. Put one block on each end of the leg blank, then place a third block near the top of the leg. Attach and adjust the clamp to hold the leg firmly, and you're ready to cut.

Raise the blade on the saw, and feed the jig into the blade keeping the right edge tight against the saw's fence. Your left hand can help guide the jig and leg for the first part of the

cut, and the jig is wide enough to complete the cut with the right hand. Both hands are well away from the blade during the cutting process. After making one cut, the clamp is released, the leg blank is turned  $90^\circ$  and the clamp is re-engaged before cutting the second taper.

This jig can be easily adapted to cut four-sided tapers. Use one edge to position the blocks for the first two cuts. The opposite edge can be used to set up the last two cuts, using one of the offcut pieces to support the bottom of the leg. —RL



**1 Simple setup.** A few pieces from the scrap bin and a handful of screws are all you need to make this jig.

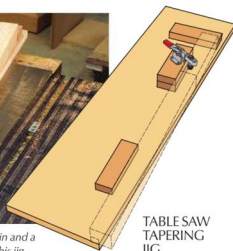

TABLE SAW  
TAPERING  
JIG

**3 Get a grip.** It's easy to knock the leg out of alignment as you place the stop blocks, so trace the outline of the leg blank on the face of the plywood with a pencil. The block of the top end of the leg is two thicknesses, allowing a hold-down clamp to be attached to the jig.



**4 Turn for second cut.** After the first cut is complete, turn the leg  $90^\circ$  and clamp it back in the jig.



**2 Position blocks.**  $\frac{3}{4}$ " x  $1\frac{3}{4}$ " blocks are screwed to a  $\frac{3}{4}$ "-MDF base that's 8" wide and 6" longer than your leg to position the legs for tapering. Attaching the stops with #6 x  $1\frac{1}{4}$ " drywall screws alone (no glue) allows you to quickly reconfigure this jig to cut different tapers.

# BAND SAW

The best reason to use the band saw to cut tapers is that there are few limitations as to what you can do. You can even use this technique to taper a pencil-post bed. Plus, there are no jigs or math.

You just simply lay out the taper you want, cut it close on the band saw then handplane the taper down to your cutline.

The other thing I quite like about this technique is that the final result is ready for finishing. Once you handplane the tapers, you don't have to sand them.

The only serious criticism of this method is that you can end up with four legs that are very slightly different. It's not a practical concern because no one will be able to see

the difference in the finished product – the legs will be too far apart from one another for differences to show. But some woodworkers are delighted by perfection.

One more note: If you don't have a handplane you can also clean up the tapers on a jointer. If you use a jointer, however, you will have to do some sanding. **PW** — **CS**



**1 Preliminary cleanup.** Before you taper the legs, dress all four faces. This will remove any slight twist and will prepare the untapered sections of the leg for finishing.



**2 If you can draw it, you can cut it.** Using a ruler or a long scrap of wood, lay out the taper on one face of your work.



**3 A critical cut.** When cutting on the band saw, don't cross your layout line. And don't shy away from it either. I shoot for cutting right next to it. This improves your accuracy. Once you've cut one face, lay out the taper on the adjacent side and make that cut.



**4 Dress the tapers.** Clamp the legs between dogs and clean off the band-saw marks down to your layout line. Almost any plane will work: a jack, smoother or jointer.



**5 Extra support.** Sometimes it helps to support the tapered foot while planing it. Use one of your offcuts from your band-saw work.

# The Barnsley Hay Rake Table

Inspired by the agricultural tools of rural England, this massive oak table is awash in hand-worked details.

**A**s a young fellow growing up in the countryside of Wales, I clambered over many a farm wagon, climbed into many a loft in barns that were jointed and pegged, and tripped over many a hay rake on my adventures.

I have always appreciated the simple, utilitarian, yet pleasing design of the vernacular woodworking of the countryside. My inspiration for furniture forms has always been the work of the wheelwright and coach maker. And the inspiration for how to build things came in part from Sidney Barnsley and Ernest Gimson.

Barnsley and Gimson were men of the Cotswolds school of craft architects. They were part of a group of London architects who moved to the countryside in the 19th century and set up what is known today as the English Arts & Crafts movement (along with William Morris at Kelmscott Manor).

These free thinkers broke away from convention and began to design not only the buildings, but the furnishings as well. And they turned to the rural countryside for their inspiration.

The hay rake table built for Rodmorton Manor was an example of how Gimson and Barnsley adopted details from farm wagons, carts and farming implements that were still in use in the Cotswolds.

The wagons of the farming community had many details a layman would not be aware of—the dish of the wheel, the complex undercarriage, the chamfering of braces for



BY DON WEBER

both decorative and structural intent. Adzed surfaces and chamfered edges added visual appeal and reduced weight in a farm wagon. The hay rake shape of the stretcher was an element found in farm equipment.

This table is made from Valley Oak (*Quercus lobata*), a gift from a friend who worked for a vineyard in Northern California. I milled the 8/4 planks eight years ago and carried them to their present location in Paint Lick, Ky., with the intent of building this very table. At last!

## Fine Joinery in the Top

The top of the table was made from two fitch-cut planks of oak that were 24" wide and 2" thick. There was some sap wood to remove, so the overall width of the tabletop finished at 40" with a finished thickness of 1 7/8".

The original design called for butterfly splines to join the planks at their edges, but I decided to dowel the edges together with 1/2"-diameter osage orange dowels. No biscuit joiner here! After assembly, I used a scrub plane to level the glued-up planks to a reasonably flat surface.

The breadboard ends on the top not only cover the end grain but also keep the top from warping. First I cut the tenons on each end. The tenons are 2" long and 3/8" thick. I cut them with a backsaw and rebate plane (which is called a rabbit plane on this side of the Atlantic). I then sawed out the spaces between the tenons (leaving a short stub between each tenon) and cleaned things up with a chisel.

For the 3/4"-wide end boards, I cut a groove with a plow plane to receive the stub, and I cut the deep mortises with a drill and chisel to receive the tenons. A router and mortising machine would, of course, also do the job.





*Built by hand.* The original versions of this table were built using lots of hand work. And so the author honored that tradition when he built his version of this Sidney Barnsley classic.

 Online EXTRAS

To see additional photos of the construction process and a SketchUp model, visit:

[popularwoodworking.com/feb09](http://popularwoodworking.com/feb09)



To secure the breadboard ends, I bored  $\frac{1}{4}$ "-diameter holes through the end boards and tenons – then I pegged the joints with ebony pegs. Be sure to make the holes in the tenons elongated so that the top does not split when it moves with the seasons.

I beveled the underside of the tabletop only slightly to leave nearly the full thickness showing. In the end, after trimming and cutting mistakes, the table began to look rather thick. This is no delicate table; let the Vikings roar!

I added butterfly inlay to the top that measured  $\frac{3}{8}$ " x  $1\frac{3}{4}$ " x  $5\frac{1}{2}$ ". I cut the recesses in the top using a chisel and a router plane. Then I did the fine fitting of the inlay with a chisel.

### The Base: Legs and Mortises

I glued up the legs for this table from 8/4 stock. I would have preferred to use a single thick piece of wood for each leg, but I wanted to use as much of the timber from the vineyard as possible. When making square legs, it is best to use slash grain (sometimes called bastard

grain), where the annular rings run diagonally across the end grain, from corner to corner. This gives you a uniform grain pattern on all four faces of the leg.

The legs have broad chamfers on all four longedges. I cut the 1"-wide chamfers the complete length of each leg with the table saw.

Each leg has a through-mortise that begins 5" up from the floor to receive a hay rake stretcher. Before drilling the waste holes for these mortises, score the final boundaries of each mortise with a marking knife to ensure



**It starts with a saw.** To make the breadboard end, I begin by sawing out the shoulder of the tenon. The block of wood acts as guide for the saw's blade.



**Remove waste in haste.** A few good whacks with a chisel and mallet popped out most of the waste.



**Trimming by hand.** Then I cleaned up the cheek and shoulder using my rabbit plane.



**Ready for the pegs.** In the finished breadboard end, you can see the stub tenon that fits into the groove and the five longer tenons.



**Fine-fitting the inlay.** After cutting the butterfly inlay to shape, I cut the recesses to receive them using a chisel and then a router plane.

there will be no tear-out when drilling out the waste.

These through-mortises were bored out with a  $\frac{3}{8}$ "-diameter brad-point bit. Then I dressed the through-mortises out to  $\frac{3}{4}$ " wide by  $2\frac{1}{2}$ " long with a mortise chisel and a 2"-wide firmer chisel.

The old fellow I learned woodworking from insisted that I should always see the reflection of my scribe line in the back of the chisel when chopping out waste. Seeing the reflection of the scribe line ensured that I'd stay inside my lines when chopping. If you chisel directly on the scribe line, the bevel of the chisel has a tendency to push the cut outside the width of the mortise.

### Building the Hay Rake

The beauty of this table is its hay rake stretcher. Its shape is taken from a heel rake, named because it follows close behind your heels. Heel rakes were used for raking hay into windows and for the final clearing of the fields. It is a utilitarian implement, yet strong and pleasing to the eye.

Building the hay rake stretcher truly is a mortise-and-tenon exercise. The tenons on the stretcher are cut on a table saw with a stacked dado blade. I then cleaned them up with a Stanley No. 10 carriage maker's plane.

All the remaining mortises are drilled and chiseled. The angled ones are bored with the work secured horizontally in a bench vise. I've tried to do these on a drill press using an angled platform, but the drill press's pillar got in the way. So back to the old ways again!

To clean up the angled mortises, I used the waste block from the end of a tenon to act as a chisel guide. All the joints here are through-mortises, except the mortises in the center stretcher.

All the through-tenons are double-wedged from the outside; the blind mortises are pinned. All the joints are drawbored, just like in timber framing, to draw the tenon into the mortise with a mechanical lock.

All the edges of the hay rake stretcher have stop-chamfers. The distinctive stop-chamfers on agricultural implements were employed mostly to reduce weight without reducing strength, according to Richard Harrison, the wheelwright in Barnsley's village. (This comes from Mary Greensted's book about the Barnsleys.)

In furniture design, chamfering remained a useful technique that required skill and thought to soften sharp edges and anticipate wear. Many of the chamfers on Barnsley's pieces were done with a drawknife alone – no spokeshave or sandpaper. I have cut



**Let your waste be your guide.** Use a guide block to steer your chisel when you chop the angled mortises for the hay rake stretcher.



**Plane to fit.** I use a carriage maker's plane to trim the cheeks of the tenons for the hay rake stretcher.



**Almost assembled.** Here you can see how the stretcher assembly comes together. All the tenons are through-tenons, with the exception of the angled tenons that meet.

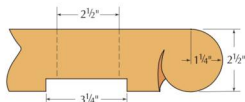

TOP CROSS BAR DETAIL

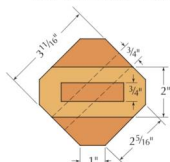

LEG DETAIL

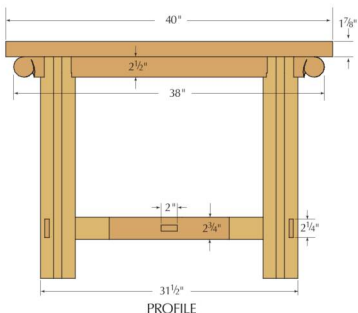

PROFILE

the stopped part of the chamfer with a draw-knife, then used a circular saw to remove the waste and used a smoothing plane to dress the surface.

Barnsley often chip-carved the edges of his furniture, but I've left off this detail.

### Bridle Joints at the Top of the Base

The legs are bridle jointed to a cross bar with a  $2\frac{1}{4}'' \times \frac{3}{4}''$  tenon centered in the top of the leg. See the drawing below for details. This cross bar has its ends cut in a scroll and shaped with a #3 sweep gouge.

I attached the top to the leg frame with buttons of iron. I'd made wooden buttons out of locust, but they looked weak with the mass of this table. So it was into the smithy for me. I searched for some time for the right size stock, but nothing showed up until I found a box of old railroad spikes. So I heated them up in the forge, flattened the sides, cut them to 1" in height and forged a dimple in the top to receive the screw.

There are simpler methods, and wooden buttons would probably work fine, but I'm a blacksmith and the table could handle their forged appearance. (Even if you have to lie on your back on the floor to view them.) The ends of the buttons are set into grooves in the cross bar, 4" in from the legs and  $\frac{3}{4}''$  down from the tabletop.

For a finish I used an oil and varnish blend that was tinted with a bit of aniline dye to bring this American oak to the rich brown tone of English oak. Hand rubbed and polished with furniture wax, it brought up the texture of the tools used in the construction of this piece.

The dimensions of this table were determined by the material I had on hand and the special nature of it. This table can be constructed from conventional lumber—2" x 12" oak for the top, 4" x 4" oak for the legs and 2" x 4" material for the rest. Conventional woodworking machinery can do a speedy job of it, but I'm a hand woodworker; the feel and texture tell me all I need to know. And I do believe Barnsley would approve. **PW**

*Don is a chaimaker and blacksmith in Paint Lick, Ky. You can see more of his work and learn about the classes he teaches at [handcraftwoodworks.com](http://handcraftwoodworks.com).*

## Barnsley Hay Rake Table

| NO. | ITEM              | DIMENSIONS (INCHES) |         |         | MATERIAL | COMMENTS               |
|-----|-------------------|---------------------|---------|---------|----------|------------------------|
|     |                   | T                   | W       | L       |          |                        |
| ❑ 1 | Top               | 17/8                | 40      | 74 1/2  | Oak      |                        |
| ❑ 2 | Breadboard ends   | 17/8                | 3 1/4   | 40      | Oak      |                        |
| ❑ 4 | Legs              | 3 11/16             | 3 11/16 | 27 1/8  | Oak      | 1" chamfers on corners |
| ❑ 1 | Long stretcher    | 2                   | 2 3/4   | 46 1/16 | Oak      | 2" tenon, both ends    |
| ❑ 4 | Angled stretchers | 2                   | 2 3/4   | 21 3/4  | Oak      |                        |
| ❑ 2 | Cross stretchers  | 2                   | 2 3/4   | 20 3/8  | Oak      |                        |
| ❑ 2 | Top cross bars    | 2                   | 2 1/2   | 38      | Oak      | Notched into legs      |

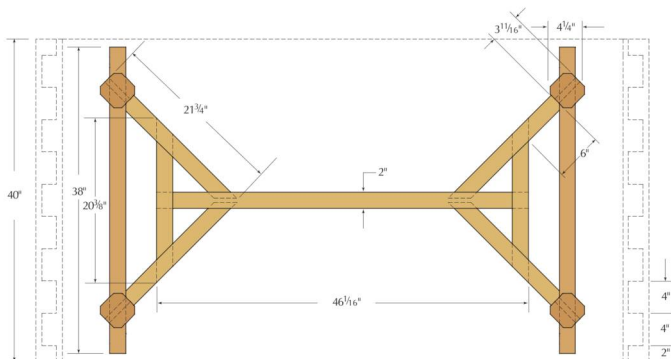

PLAN

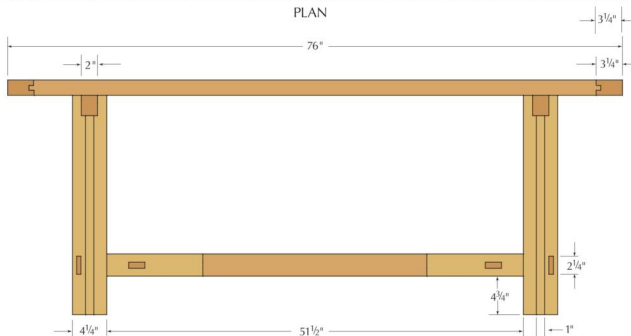

ELEVATION



# *D.L. Barrett & Sons*



## *Planemakers*





**Complex and crisp.** The moulding on the fence is remarkably crisp, even as it returns across the front. Here you also can see (if you look closely) the boxwood lining and the two sliding dovetails that attach it.

**Brass, iron and wood.** The skate iron and depth stop all come together seamlessly. The tapered A2 irons all seat firmly against the skate and are held securely by the wedge. The set of eight well-made irons is just one of the selling points of this tool.

**W**hile modern carpenters might show off at the jobsite by driving up in a fully loaded pickup truck, the 19<sup>th</sup>-century cabinetmaker did the same thing when he pulled out his plow plane from his tool box.

Plow planes were usually the most expensive tool in an early woodworker's tool kit. While all the other tools in the woodworker's chest might be iron or beech, the plow plane could be made from an exotic wood, be highly decorated and use complex adjustment mechanisms. In fact, sometimes a particularly fancy plow plane would be presented to an employee as a retirement gift.

To me, it's amazing that all this effort went into a tool that really did only one thing: cut grooves.

---

**Ready to work.** This bridle plow – based on the famous Matheison – was built by an 18-year-old student now studying tool and die making.

**His third plane.** Kyle Barrett (inset) holding the third plane he built.

Because plow planes were some of the fanciest tools made, they also are one of the most collectible today.

Unlike a number of tool collectors I know, I don't have a full-blown plow-plane obsession. Ebony screw-arm plows with ivory tips and silver fittings are beautiful and ingenious, but I've always thought that their flashy details somehow diminish them because they make them too nice to use – like a table saw with a solid gold top.

In my work, I've always used metal-bodied plow planes, though they eject shavings into your hands, are cold and seem heavier than their wooden cousins. The overriding advantage of the metal plows, however, is that their fences are easier to keep parallel to the tool's skate than a typical wooden screw-arm plow plane.

As a result, what I've always wanted is a wooden-bodied plow that has a robust and easy-to-adjust fence. My search ended last year when I judged a toolmaking contest put

on by the [WoodCentral.com](http://WoodCentral.com) web site and sponsored by Lee Valley Tools.

For that contest, we judged more than 60 tools that had been brought into Lee Valley's board room in Ottawa, Ontario. The moment I walked into that room my eyes locked onto a beech-bodied plow plane with ebony arms and a simple metal fence-locking mechanism.

When I finally got to pick the tool up, I was impressed by how lightweight it was and how the fence slid smoothly on its arms and locked with the quick twist of a thumbscrew. The real test, however, came when I started plowing grooves using a workbench that Lee Valley employees had moved to the boardroom.

The plow plane both glided over the work and removed a sizable shaving. It was the easiest groove I'd ever cut by hand in maple. This was a surprise. Usually with tools as complex as a plow or a moving fillister plane, there's a break-in period while the tool and its user circle each other and neither performs at the top of their game. This plow plane was different.

BY CHRISTOPHER SCHWARZ

Meet the young (he's just 18) and skilled hands behind a near-perfect tool.



It was like I'd been using it all my life. My first groove with the tool was a total success.

After a couple days of discussion, we awarded that plane first place for craftsmanship, and I resolved to track down its maker and ask that person to build one for me.

When I finally got in touch with him, I was shocked to find out that the maker was Kyle Barrett, an 18-year-old high-school student in Barrie, Ontario, who had built the plane in his father's workshop. I was even more shocked to learn that his prize-winning plane was only the second handplane he'd ever made.

### 'I Enjoy Seeing How Things Work'

Kyle's toolmaking adventure began years ago in his father's shop. Dan Barrett is a trained carpenter and cabinetmaker with more than 25 years of experience in building and teaching. When Dan built the family's living room chairs, Kyle was right there in the shop watching the process and helping where he could. When Dan built some shelves that looked like an airplane flying out of a wall, Kyle was there as well.

"I thought it was really cool getting to see how things were made," Kyle says.

Then Kyle took a shop class at high school and resolved to challenge himself by building a walnut grandfather clock. To make the beading on the clock's ogee bracket feet, Kyle had to make a simple handplane for the job.

"I really enjoyed that," Kyle says. So the pump was primed when he happened upon an ad for a toolmaking contest in one of his dad's Lee Valley flyers.

To enter the contest, he had to figure out what tool to build. As Kyle was flipping



**Handworked details.** The brass caps on the ends of the ebony stems are wedged tight. The amount of detail on this plane is extraordinary.



**Curved and comfortable.** The beech tote is hand-shaped and has no hard lines to rip at your fingers.

through "Wooden Plow Planes" by Donald Rosebrook and Dennis Fisher he spied a Hermon Chapin plow plane on page 98. That Connecticut-made plane was very similar to a Scottish-made Mathieson bridle plow, and Kyle locked onto that plane and resolved to build a version of it for the contest.

His plane combined elements of both the Chapin and Mathieson planes, and he added a couple significant details of his own. From Mathieson, Kyle took the basic overall shape and fence-locking mechanism. But he swiped an improvement from the Chapin: The plane's ebony arms sit in a brass liner on the tool's fence. Kyle also improved the tool by adding a boxwood facing to the plane's fence — it's attached with sliding dovetails.

Kyle and his dad both insist that Kyle did all the work himself, including the complex metalwork on the bridle mechanism. And after a few minutes of talking to Kyle, you have little doubt that he is capable of building a tool

like this. He really knows his stuff.

"My dad was very adamant that I learned the proper techniques to use when doing anything," Kyle says. "He would always say that there was a right way and a wrong way to do something, and he would always go out of his way to make sure I was learning the right techniques. I could never have made the same quality tool without him passing on his knowledge and experience."

The plane took about 120 hours to build and almost didn't make it into the contest. At one point, Kyle said he mortised the plane's depth stop lock on the wrong side of the skate and he had to start building the body all over again.

"Do you remember what time the contest's deadline was for entries?" Kyle asked. "Well, we made it in with about three minutes to go."

The tool was fun to build, and Kyle was surprised by how well it worked, especially considering it was his second plane and how



**No-fail locking mechanism.** The bridle mechanism is flawless in workmanship and in function. The fence locks parallel to the skate every time, which saves an immense amount of fussing.





**The right irons.** The irons that come with the Barrett plow plane are a joy, especially if you have been messing with vintage ones for so long. The irons are well ground and properly shaped.

tricky it had been to line up the iron and skate of the tool.

### A New Company and College

Meanwhile, Kyle's father had also been making planes in his one-car garage, and with Kyle's interest in toolmaking ignited, Dan decided to start making planes for sale under the name D.L. Barrett & Sons.

Kyle, Dan and his younger brother, Jeremy, all work in the shop, which is filled with all the basic woodworking machines, plus a small milling machine, metal-cutting band saw and metal lathe.

As of now, the company offers three kinds of plow planes and three bench planes. In the works for the future are fillister, dado and moulding planes – most likely complex moulders. The plow planes come with a full set of eight tapered A2 irons, made by a Canadian company, which are also things of beauty. They taper gracefully from  $\frac{3}{8}$ " thick to  $\frac{1}{8}$ " thick at the ends. The unbeveled faces of the irons are remarkably flat and the V-groove that rides the plow's skate is crisp.

At the time of the interview, Dan and his sons were building nine tools: four Mathieson plows, three V-plows and two open-tote jack planes. But the plane-making work is sometimes interrupted by homework. That's because Kyle has just started in the tool and die-making program at nearby Georgian College.

"It's really neat, actually," he says. "Already I've learned so much about metalworking. There is so much more you can do to make it easier."

After a week of studying blueprint reading or machine processes, Kyle can be found in the shop with his family working out some of the details of his planes. But after Kyle fin-

ishes the two-year program, he's not sure what he'll do.

"I don't know if I'll have enough skills to go out on my own as a toolmaker," he says. "I'm 18, and I'm not sure where I'm going yet."

### A Remarkable Worker

I hope Kyle continues as a toolmaker. After the contest ended, I asked him to build one of his plows for me that would be a worker in my home shop (instead of a trophy on the mantle). At the time I didn't even ask the price, though I consider the \$1,875 (Canadian) price tag for the base model to be fair considering all the handwork and the full set of irons included with the tool.

The plane Kyle built for me is only slightly different than the prize-winning plow. Instead of steel, mine has a bronze bridle mechanism. And it is signed "D.L. Barrett &

### Supplies

D.L. Barrett & Sons Toolworks  
705-739-8905 or  
[dlbarrettandsons.com](http://dlbarrettandsons.com)  
112 Wessinger Drive  
Barrie, Ontario, Canada, L4N-8P5

Sons." Plus—I have to be fair here—I think my plane is even better than the plane that won the contest in February 2008. (Dan agrees with me, by the way.)

The plane feels like it is ready to go to work as soon as you pick it up. Unlike other plow planes, the controls of a bridle plow are remarkably intuitive—even power-tool woodworkers who pick it up understand the mechanism immediately.

All the brass fittings are perfectly mortised into the brass and ebony parts. The beech wedge is a seamless fit into the stock.

How does it work? I hate to think that anyone will buy one of these planes and put it in a glass display case. The D.L. Barrett & Sons plane is graceful and nimble in both hardwoods and soft. It is easily the nicest plow plane I have ever used.

Which begs the question: What did Kyle do with the tool that won the contest?

"It's in the shop," he says. "We have it in a place to keep it up out of harm's way. But I always like to take it down and use it." **PW**

*Christopher is the editor of Popular Woodworking and Woodworking Magazine. You can visit his personal web site to read more about tools at [LostArtPress.com](http://LostArtPress.com).*



**Superb spirals.** The proof of the plane is in the thick, spiral shavings that peel off the board. You want to get the work done quickly, so a stable tool that can take a heavy shaving is a must.

# Finishing Cherry

Some straight talk about cherry and blotching.

**W**hen I opened my furniture-making and restoration shop in 1976, the woods considered best for high-end furniture were walnut and mahogany. Of course, oak and maple were also used, and sometimes cherry.

As had been the case through the previous three centuries, cherry was still thought of as the poor man's substitute for mahogany. The coloring is similar, but mahogany had always been considered the higher quality wood. A large part of the reason is that mahogany colors evenly and cherry blotches.

Blotching is uneven coloring caused especially by stain penetrating deeper in some areas and leaving more color when the excess stain is wiped off the surface.

Times have changed, and cherry is now the favored wood with a great many woodworkers. Mahogany is hardly even considered for use anymore, and neither is walnut very popular. But cherry still has the blotching problem and everyone wants to know how to deal with it.

## The Solution Problem

Magazine editors like to please their readers, so you see lots of articles addressing the question of how to avoid blotching in cherry.

The method for reducing blotching under a stain is widely understood. Simply apply a washcoat before applying the stain. A washcoat is any finish thinned to about 10 percent solids: that is, varnish thinned with about two parts paint thinner, shellac thinned to a  $\frac{3}{4}$  pound cut, or lacquer thinned with about  $1\frac{1}{2}$  parts lacquer thinner.

Once you have allowed the washcoat to dry thoroughly (especially critical when using a slow-drying varnish washcoat commonly sold as "wood conditioner"), a stain penetrates very little so blotching is reduced. Less penetration limits the darkening of the wood, however, so there's a trade off. Staining is less effective.



**Cherry blotches.** All clear finishes cause blotching in cherry. The finish on this cupboard is boiled linseed oil topped with lacquer. The linseed oil darkens as it ages, so the color of the cherry will deepen more quickly than with other finishes. The lacquer provides better protection and shine. If you combine linseed oil with another finish, including lacquer, be sure to let the linseed oil cure thoroughly before applying the other finish – at least a week in a warm room.

But cherry blotches even without a stain. All clear finishes (even shellac, which is often promoted as an exception) blotch cherry and, of course, so does a washcoat. It seems there's no way to totally avoid the blotching.

This hasn't, however, stopped magazines over the years from keeping the possibility alive, hinting that there might be a secret method somewhere.

## Not Always

One of the joys of woodworking is that we get to work with so many different woods, each of which has its own special characteristics – some of which we like and some we don't. Cherry machines very nicely and has an especially pleasant aroma, but it blotches.

At least it usually blotches. Just as with pine and birch, which are also notorious for blotching, the blotching in cherry and whether it looks nice or not depends on the particular board. Some boards blotch in a particularly ugly way. Some blotch in a beautiful way – often referred to as curly or mottled. And some don't blotch at all.

Unfortunately, no wood supplier grades cherry (or any other wood for that matter) by its blotching characteristics (though veneers are graded for curly and mottled). Wood suppliers grade wood for the number and size of its knots.

So you have to figure out for yourself how the cherry you are using will finish. This is much easier to do with surfaced cherry than with rough lumber.

With both situations, the easiest way to see how a finish will look on the wood is to wet the wood. Wetting gives almost the same appearance as a finish does, the difference being that the wetting evaporates and a finish turns to a solid making the coloring permanent.

You can use any liquid, but non-grain-raising liquids such as mineral spirits, alcohol and lacquer thinner are usually best, especially on surfaced wood.

## Aging and Darkening

Besides blotching, another quality of cherry is the tendency of its heartwood to darken as it ages. The darkening is brought about by exposure to oxygen and light. Light accelerates the process, especially UV light, such as sunlight and fluorescent.

As cherry darkens, the blotching becomes muted – that is, the lighter non-blotchy areas darken to the color of the darker blotchy areas.



**Washcoats.** The left side of this cherry panel was washcoated, then Minwax cherry stain was applied to both sides (there is no stain on the middle stripe). Notice that the washcoat reduced the intensity of the blotching a little but didn't totally eliminate it. The washcoat also prevented the stain from coloring the wood as much.



**Cherry variations.** Cherry doesn't always blotch. It depends on each specific board. Both of these panels were finished with a clear finish – no stain. The left panel didn't blotch and the right blotched severely.



**Test for blotching.** The easy way to test for blotching is to wipe the surface of unfinished cherry with a liquid. Any liquid will work, but solvents such as alcohol, mineral spirits and lacquer thinner are best because they don't raise the grain like water does. It's much easier to see if a board will blotch when the test is done on surfaced cherry than on raw, unsurfaced cherry.



**Natural darkening.** Cherry darkens as it ages due to exposure to oxygen and light. This 60-year-old chest has taken on the rich rust-red color typical of old cherry. Notice that the darkening has served to mute and disguise the darker blotching somewhat as the lighter colors have darkened to blend.



So time does a pretty good job of disguising blotching in cherry. This is the reason I've always believed that the best way to finish cherry, if your goal is to make it look like old cherry, is to let it get there naturally.

You can always accelerate the darkening a little by placing the ready-to-finish or already finished wood in the sunlight for a few days. This will darken the heartwood a little, but it will still take years to reach the rust red color of old cherry.

If you want to achieve the rust-red color immediately, and are using non-blotchy cherry or are willing to live with the blotching, the most accurate way to do so is to stain the wood with a cherry dye stain. But keep in mind that the wood will still darken under the stain, giving you a result you, or your customers or descendants, may not be so pleased with after several decades.

### How Factories Do It

If you've ever looked at factory-finished cherry furniture, you've surely noticed that it doesn't look like old cherry. It's usually considerably darker, sometimes so dark and opaque it's even difficult to see that the wood is cherry. But it's not very blotchy.

Cherry furniture manufacturers solve the blotching problem by putting most of the color on top of the wood rather than in it. Instead of using stains, they get the color with glazes and toners. Glazes are thickened stain applied in between coats of finish. Toner is the finish itself with the color (usually dye) added. Toner is always sprayed.

The end result is reduced blotching because it is covered over. Though there's no reason you couldn't finish cherry in this manner yourself, the look attained is not what most woodworkers want.

### Conclusion

Here's the bottom line on cherry: Most boards blotch when stained, and also when finished without a stain. There's no way to avoid this, other than finding boards (or veneer) that don't have the tendency.

Over time the blotching is muted as the heartwood darkens naturally to a rust-red color. If you choose, you can get to this color immediately by staining with a cherry-colored dye stain. But in time the wood will darken further underneath the dye.

You can also add color and disguise the blotching with glazes and toners, but you can't

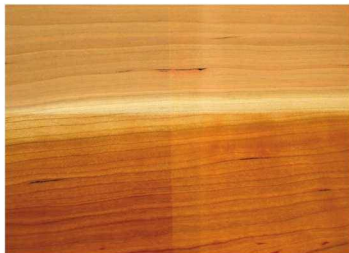

**Running start.** Because the darkening of cherry is accelerated by light, you can place your sanded parts in sunlight for a couple of days (as I did with the left half of this panel) and achieve some degree of darkening to begin the process. The bottom half has a clear finish applied. The middle stripe is where some of the UV passed through the masking tape.



**Factory finish.** Furniture factories disguise blotching by using glazes and toners to put most or all of the color in the finish rather than in the wood. This creates a different appearance than naturally aged cherry.



**Dying cherry.** If you are using relatively non-blotchy wood or are willing to live with the blotching, you can achieve a color very close to aged cherry immediately by using a cherry dye stain (left). Lockwood natural antique cherry water-soluble dye (also sold as Moser natural antique cherry) provides the most accurate coloring in my experience. These dyes are available by mail order from many suppliers. But keep in mind that the color of the wood under the dye will still darken and result in a much darker coloring after a number of years than you may want.

achieve the rich, transparent rust-red look of old cherry this way.

The only way to get the old cherry look is to finish with just a clear finish, any clear finish, and let the wood age naturally. **PW**

*Bob is author of "Understanding Wood Finishing" and contributing editor to Popular Woodworking.*

# Using Wood to Make Waves

Reuben Margolin uses scraps to explore science, nature and math.

**A**t this moment, Reuben Margolin is building a gigantic wooden sculpture that moves. It's titled "Yellow Linear Wave," and is one of his many creations—usually built out of discarded pieces of redwood, bits of leftover metal and fishing tackle—that he calls "geometrical constructions flavored by art."

"Yellow Linear Wave" is 16' long, 6' wide and has 120 rods topped with poplar blocks painted yellow. While it's made mostly from poplar and Finnish plywood, it also includes parts of aluminum and UHMW (a slippery kind of plastic).

But what does it do?

Margolin created this sculpture to explore what happens when a sine wave with three peaks is added to a sine wave with four peaks—or, in general, to find out what happens when



**The artist.** Reuben Margolin creates kinetic sculptures to explore the undulation of caterpillars, grass moving in the wind, the motion of the waves and other natural phenomena. In "Yellow Rings," pictured above, each spiral drive creates a wave motion in the painted yellow rings.



**The Round Wave.** A plywood cam in the center of the mechanism causes the concentric rings to rise and fall in a ripple-like fashion.

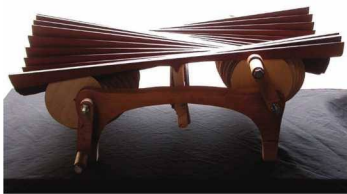

**The Redwood Wave.** Each handle drives a camshaft that causes the wave to undulate. This sculpture is made of redwood salvaged from a deck.



**The Square Wave.** Two camshafts work in unison to add together orthogonal waves in a suspended wooden grid.



**The Spiral Wave.** This piece was inspired by the eddy that Margolin saw peeling off a paddle while rafting down the Green River. The whole mechanism turns, while a separate electric motor causes a curved rotational wave in the suspended aluminum tubes.

he adds two waves with different wavelengths. The whole thing is powered by two electric motors, and its movement mechanism is controlled by Dacron string.

Margolin, who is based in Emeryville, Calif., uses wood to explore natural phenomena, from the motion of a caterpillar, to the way the wind blows over a wheat field. His creations use the familiar material of wood in ways that would surprise a typical woodworker, including constructions that employ wood to mimic how a drop of water hits a lake or even to illustrate a complex math equation.

While his work is definitely artistic sculpture, Margolin's work also appeals to the mechanical mind, thanks to his own fascination with gears, cams and pulleys.

### The Learning Curve

Margolin has long been fascinated by nature, and the physical phenomena found in it. And

he says he's been "making stuff" for as long as he can remember. He received a wrench when he was 8, and he remembers taking apart a seat with it while riding on a ferry. He has always been fascinated by tools, as well as mathematics and geometry, which he calls a "practical, hands-on approach to math."

Though Margolin has never taken formal woodworking classes, his father owned woodworking tools, so they were always around the house. His father was an amateur woodworker, so Margolin got to play with his handplanes, a brace and bit and an eggbeater drill. When he was 8, Margolin tried – unsuccessfully – to

start a business selling wooden duck puppets he cut out of pine with a jigsaw and painted orange. When he was 16, he made a canoe paddle, and when he was 18, he attempted a canoe (which remains unfinished to this day).

Margolin also learned a lot about building on a larger scale at Lodestar Magnetics, a company that constructs magnetically shielded laboratories. He's worked for Lodestar for about one month per year since he was 18, and he has picked up a lot of skills from the company's craftsmen. At Lodestar, Margolin learned framing, trim work, attention to detail and "simply how to keep working on a large project until it got finished." He says most of his woodworking skills have come from both "messing around," and on these carpentry jobs. And thanks to those skills he also takes on commissions for custom furniture (not to mention the occasional rickshaw) from time to time.

### Online EXTRAS

To watch videos that show these wood sculptures in motion, go to:

[reubenmargolin.com](http://reubenmargolin.com)

As an artist, Margolin didn't start as a sculptor; he trained as a fine artist at Harvard University (where he received a degree in English), and afterward attended classical painting schools in Italy and Russia, where he learned to study nature and create large-scale paintings.

But it took an insect to plunge him into the world of mechanical engineering and kinetic wooden sculptures.

### The Caterpillar that Moved Him

Margolin's engineering exploits began while he was observing a caterpillar undulating its way across desert sands. He wondered how he could create a device that would mimic that movement.

His first step was to re-learn calculus, which took about three months. Then Margolin began building. His third attempt at a mechanical caterpillar was 5' long and was composed of

springs, cables, welded pieces of metal and mechanical linkages, all attached to a turning Plexiglas wheel, which resembled the classic steering wheels found on the tall, masted sailing ships of the 18th century.

As the wheel was turned, a knob slid in a curved path cut into the Plexiglas. As the knob passed particular points in the curve, it would move cables that would then actuate different parts of the caterpillar. The knob's path was the only part of the creation that caused the caterpillar to move in a caterpillar-like way.

Margolin uses basically the same procedure to create all of his wooden and mechanical marvels. Usually, he is first inspired by nature (water, or grass waving in the wind, for example). Sometimes, he is inspired by the mechanical simplicity of bicycles.

Then he sketches the sculpture in a notebook, noting measurements. Next, he moves to his drafting table, where he uses compasses and rulers to make a more accurate drawing of the proposed sculpture. Margolin then builds a quick scale model out of cheap materials to make sure that the proportions are correct. Finally, he builds the full-size sculpture.

### Why Wood?

Margolin uses a lot of salvaged wood in his work. Recently he acquired 14' lengths of clear 2x6 redwood from a salvaged deck. He also uses salvaged maple from old futon frames, as well as some salvaged fir and oak balusters. To supplement the salvaged material, Margolin buys Finnish plywood, Baltic birch plywood and some poplar, as well as rough lumber and construction-grade plywood.

Margolin says he likes working with wood for several reasons: It's easy to use, he can cut it using inexpensive tools, it's strong for its weight and it's beautiful. He also likes that wood is "linear in nature," but can easily be made into planes, such as plywood.

However, Margolin admits that making mechanical things with wood can be challenging, because wood is not "an abstract material, not homogeneous like aluminum." Its seasonal expansion and contraction can interfere with his sliding parts and pulleys.

### Putting Wood in Motion

Many of Margolin's pieces have to be seen to be appreciated, and you can view short movies of his pieces and their motions at his web site: [reubenmargolin.com](http://reubenmargolin.com).



**The Double Raindrop.** Inspired by the pattern two raindrops make falling near each other in water, this piece contains more than 500 pulleys and 3,000 feet of cable. The frame is made of salvaged fir and Baltic birch plywood, and the wave below it out of birch dowels and hand-cast lead weights.



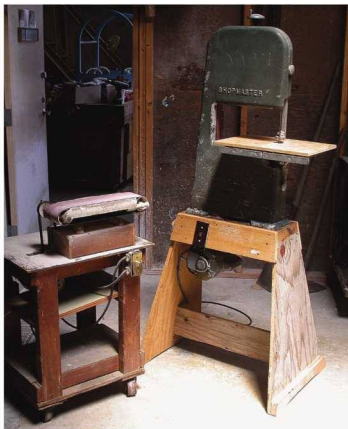

**Chisels, gouges and rasps.** The handles for the files and rasps are made from an acacia tree that was cut down nearby. The holders are made of bamboo.

**Old favorites.** A vintage Shopmaster band saw and an old belt sander are two of the machines Margolin uses to create his kinetic sculptures.



**Miscellaneous hardware.** On top is a grinder on an acacia base.

I saw one of Margolin's largest sculptures, "Square Wave," at the Exploratorium, San Francisco's museum of science, art and human perception. "Square Wave" stands about 12' tall, is about 12' wide and looks like a giant patchwork quilt of connected, hollow wooden squares. Each square is composed of four wooden structures made from dowels. At every intersection of two dowels, a metal wire rises to an elaborate web of cams, wooden arms and metal above the quilt.

Like Margolin's other sculptures, "Square Wave" is powered by an electric motor, and when the switch is flipped, the cams and arms move, which then pull on the wires. As a result, the quilt of dowels and fishing tackle rises and falls as if it were gently floating on an ocean. The effect is both hypnotic and soothing. In effect, Margolin has used oversized Lincoln Logs and an Erector Set to build an enormous contraption that demonstrates the wave motion that all physics students learn about.

Another of Margolin's sculptures, "Round Wave," is composed of eight nesting wooden hoops arrayed like a giant Slinky. Each hoop is suspended by wires from wooden rods attached to the ceiling of Margolin's studio. When the sculpture is turned on, a roller at

the top passes under each rod in turn. This causes the hoops below to alternately rise and fall. The resulting movement looks like a circle turning inside out, over and over again.

A third creation, "Redwood Wave," is smaller and is powered by human hands. This sculpture is made of redwood and looks like an open box measuring 3' square. Inside are about 20 wooden bars that have been balanced over two wooden axles. Inserted into the axles are wooden circles placed in a spiral pattern. The axles connect to two handles placed at the bottom of the box. Turning the handles turns the axles, and because the wooden circles are offset, they act as cams, which cause the wooden bars to rise and fall in a wave-like motion. Turning the axles together creates even more complicated patterns.

One of Margolin's round-wave sculptures now hangs in the Chabot Space and Science Center, in Oakland, Calif. This 18"-diameter sculpture was inspired by ripples in water, but instead of being circular, it is hexagonal.

### Studio Space

Margolin's Emeryville studio is in an old, warehouse-type building that formerly housed a small ceramics factory; he now shares his space with a specialty soap manufacturer. In

addition to his California studio, Margolin has worked in Ahmedabad, India. There, as an artist-in-residence at the Kanoria Center for the Arts, he built mechanical, human-powered butterflies using rickshaws, bamboo and hand-dyed muslin cloth. The resulting creations, when pedaled, "flapped and fluttered down the streets of Ahmedabad," he says.

Despite his love of the mechanical and his affection for wood, Margolin says his goal in making sculptures, is simply to "make something beautiful," whether mathematical or not. **PW**

*Raphael is a science writer who lives in San Francisco; he works at the Exploratorium. He is interested in the history and philosophy of science, as well as any kind of engineering.*



# A Puzzling Beginning

How one woodworker got over her fear of dismemberment: more fear.

**I**ndustrial Technology. That was the name of the course I took in the autumn of 1993. Beats me as to why it was entitled thus, because anyone with two brain cells to rub together could easily see that it was really woodshop, but I'm guessing that it was an offering to the gods of political correctness. The two capital letters and the extra six syllables weren't long enough to hide the power tools, the piles of lumber or remove the scent of freshly cut wood from the air. This was woodshop, no doubt about it.

When I first entered the shop, I was a scrawny little kid, on the verge of turning 13. I hadn't worked with tools before, because my dad was not a mechanically inclined kind of guy; and even if he were, as one of a multitude of girls, I wouldn't have been expected to help him. Also, thanks to the vigilant efforts of the teacher, Mr. Ferguson, who had spent several class periods beforehand instilling in us what he called "a respect for the machines," I was scared stiff. Tales of hair being ripped from scalps, fingers crushed or clipped, blades flying free and slicing through bodies like a hot knife through butter haunted me for several hours after the bell had rung.

It didn't help matters that he had ever-so-thoughtfully gored his own thumb with the drill press earlier that semester. This was supposed to be the guy who was to teach us kids to properly use the tools, and here he'd gone and given his thumbnail a skylight. To my pre-teen mind, that was a sound basis for a healthy amount of hesitance.

So it was with that frame of mind that I walked into the woodshop for the first time, bearing a 6" x 6" piece of plywood. If I'd gripped that square any harder, I'm pretty sure that I would've gone down in history as the first person to have successfully juiced lumber. At least I wasn't dealing with the aforementioned



drill press at that time; my assignment was to make a jigsaw puzzle, which meant dealing with the band saw.

Fifteen years later, I still see that as some sort of bait-and-switch. Here I'd been thinking that jigsaw puzzles were made with a jigsaw, but what can you do?

In any event, you can imagine the trepidation with which I approached my task. As I lined up the wood with the blade, images of maimed hands flew unbidden across my mind. One slip-up, and I'd be relegated to a lifetime of counting to only 9<sup>1/2</sup>. Or less.

Considering how on-edge I was, it shouldn't be any surprise that I was gripping the wood a bit tightly. Fear has that effect—the irrational need to hold fast to something, even if it's not likely to be of any great help. And sometimes giving in to that need results in more damage being done than not.

In this particular case, it would certainly explain why I jerked the wood violently off to the side in response to Mr. Ferguson dropping a stack of wood, making a loud, clattering noise. I didn't lose a finger, but I did cut a massive swath through the plywood. In retrospect,

I'm lucky I didn't break the blade. However, I did manage to cut through several of the layout marks I had made, effectively fouling up the puzzle beyond all recognition.

When your nerves are already dialed up to 11, there are two ways you can go: You can either delve into a level-five freak-out, or your anxiety can be transferred to something else. I went for the latter. I had to turn some assignment in at the end of the class, and I had several of my peers in line behind me, waiting for their turn at the band saw. My puzzle was shot. What to do?

Looking at the wreckage, I figured that I had at least done myself a favor by plotting the puzzle pieces so large, in that they provided me with some sizeable chunks to work with. The spare pieces of wood were big enough that I could fashion some little figurines. Quickly, I began to guide the wood through the blade, and I managed to churn out some crudely shaped objects in silhouette, with no lines to guide my way. Any worries about losing any part of my hands were now gone. My goal was to turn something in, even if it meant that some of it was stained with a generous portion of my DNA.

In the end, I had four figurines: a bird, a cat, an apple, something that had started out as a daisy but ended up resembling an asterisk on steroids. And I had all 10 of my fingers. As projects go, that looked like a success to me. Mr. Ferguson must have thought so too; he gave me credit anyway, and I wound up being one of his best students.

But even so, I still didn't want him to help with my next project—wiring a soda pop can lamp. I dida that at home instead. **PW**

*Micaela Evans has been telling tales since she could talk, but it wasn't until her senior year of high school, when her English teacher told her that she ought to write them down, that she gave any thought to being a writer.*