

Toshio Odate Reinvents Drawer Joinery

POPULAR Woodworking MAGAZINE

OCTOBER 2010 ■ #185

Arts & Crafts Sideboard

An Updated Recipe
Yields a Tasty Buffet

Veneer: The Future
Of Woodworking
(And That's Good)

Michael Dunbar's
7 Fixes for Bad
Bowsaw Technique

Factory Cart Coffee
Table – In 1 Day

2 Pages That Will
Change the Way
You Glue Joints



Free Video on Greene & Greene Finger Joints: Visit popularwoodworking.com/oct10

twmedia US \$5.99

0 74470 01355 6 10

Display until October 18, 2010

popularwoodworking.com



Introducing the

DAZZLING WHITE MACHINES THAT MATCH

G0715P
10" HYBRID TABLE SAW
WITH RIVING KNIFE
INTRODUCTORY PRICE

\$139
Shipping
ANYWHERE IN
LOWER 48 STATES

\$758⁰⁰



THESE MACHINES
ARE OF THE SAME
HIGH QUALITY AS
OUR REGULAR
GRIZZLY VERSIONS!



G0513P
17" HEAVY-DUTY
BANDSAW
INTRODUCTORY PRICE

\$698⁰⁰

\$89
Shipping
ANYWHERE IN
LOWER 48 STATES

(shown with
optional wing)

G1035P
1½ HP SHAPER
INTRODUCTORY PRICE

\$69
Shipping
ANYWHERE IN
LOWER 48 STATES

\$498⁰⁰



G0656P 8" JOINTER
INTRODUCTORY PRICE

\$139
Shipping
ANYWHERE IN
LOWER 48 STATES

\$728⁰⁰

G0656PX 8" JOINTER
WITH SPIRAL CUTTERHEAD
INTRODUCTORY PRICE

\$139
Shipping
ANYWHERE IN
LOWER 48 STATES

\$998⁰⁰



MORE DETAILS FOR THESE MACHINES ON OUR WEBSITE.



Grizzly Industrial®

Purveyors of Fine Machinery®, Since 1983!

3 GREAT SHOWROOMS! BELLINGHAM, WA • MUNCY, PA • SPRINGFIELD, MO



POLAR BEAR SERIES™

GREAT LOOKS WITH QUALITY PERFORMANCE!

**G0453P 15" PLANER
INTRODUCTORY PRICE**

\$139 shipping
ANYWHERE IN
LOWER 48 STATES

\$898⁰⁰

**G0453PX 15" PLANER
WITH SPIRAL CUTTERHEAD
INTRODUCTORY PRICE**

\$139 shipping
ANYWHERE IN
LOWER 48 STATES

\$1398⁰⁰



**G0459P
BABY DRUM SANDER
INTRODUCTORY PRICE**

\$528⁰⁰ **\$69** shipping
ANYWHERE IN
LOWER 48 STATES



**G0555P
ULTIMATE 14" BANDSAW
INTRODUCTORY PRICE**

\$89 shipping
ANYWHERE IN
LOWER 48 STATES

\$398⁰⁰

**G0452P
6" JOINTER WITH
BUILT-IN MOBILE BASE
INTRODUCTORY PRICE**

\$69 shipping
ANYWHERE IN
LOWER 48 STATES

\$398⁰⁰



MORE DETAILS FOR THESE MACHINES ON OUR WEBSITE.

12851R

OVER 12,000 PRODUCTS ONLINE!



MENTION THIS CODE
WHEN PLACING YOUR ORDER

1-800-523-4777 grizzly.com®

TECHNICAL SERVICE: 570-546-9663 FAX: 800-438-5901



For more information, go to PWFREEINFO.COM.

WOODCRAFT®

For A Free Catalog Or To Find Your Local Woodcraft Store, Visit woodcraft.com Or Call 800-225-1153.

NEW!



1.75 HP Professional Cabinet Saw

- Plug in anywhere: 1.75 HP, 120 V – With 20 Amp Circuit Breaker
- Includes 30" Premium Fence
- A True Heavyweight Cabinet Saw With No Compromises In Design And Components
- Features Sawstop's Patented Safety System That Stops The Blade In Milliseconds
- Industry-Leading Dust Collection: The Most Efficient Below-Table Dust Collection Available

846918

**FINGER
SAVER**
Sweepstakes

Enter for a chance to

WIN

One Of Three Great Prizes

Grand Prize: 3 HP Industrial Saw with 52" Fence, Board & Legs - Value \$3,637

2nd Prize: Pro Saw 1.75 with 30" Premium Fence Value \$2,299

3rd Prize: Contractor Saw with 30" Aluminum Fence - Value \$1,599

Visit Your Local Woodcraft Store or woodcraft.com/fingersaver For Details!

QUALITY WOODWORKING TOOLS • SUPPLIES • ADVICE® 10PW10P

For more information, go to PWFREEINFO.COM.



34



38



52

FEATURES

26 Arts & Crafts Buffet

This contemporary server combines classic elements from traditional Arts & Crafts masters including Gustav Stickley, Harvey Ellis and Greene & Greene – a recipe for design success.

BY ROBERT W. LANG

ONLINE ▶ Finger Joints

Watch Bob's video on how to cut Greene & Greene-style finger joints at the table saw. popularwoodworking.com/oct10

34 Understand & Use a Bowsaw

These traditional tools are woefully misunderstood by modern woodworkers – here's a primer.

BY MICHAEL DUNBAR

ONLINE ▶ Bowsaw Ergonomics

Get an even better understanding of the ergonomics and proper motion of bowsaws by watching this video of Mike in his shop. popularwoodworking.com/oct10

38 Veneer is the Future: Part 1

Marc Adams contends that the material once used on the finest furniture of the past should be part of your woodworking future. And he shows you how to get started.

BY MARC ADAMS

ONLINE ▶ Veneer Mill Visit

We visited Danzer Veneer – take a look inside this Edinburgh, Ind., mill. popularwoodworking.com/oct10

46 Magobei's Dining Table: Part 2

The fear of a sagging tabletop leads to an innovation in drawer design.

BY TOSHIO ODATE

ONLINE ▶ Calculating Drawer Parts

With a fitted drawer front, you can easily calculate the balance of the drawer parts. Watch as Senior Editor Glen D. Huey shows you how. popularwoodworking.com/oct10

52 Where Does the Glue Go?

An experiment exposed under Plexiglas reveals thirst, not starvation, leads to weak glue joints (and it leads the author to adopt a new gluing technique).

BY ROBERT W. LANG

ONLINE ▶ Three Methods

Watch through the Plexiglas as Bob and Senior Editor Glen D. Huey compare different methods for gluing up mortise-and-tenon joints. popularwoodworking.com/oct10



46



18



22



54

REGULARS

8 How You Can Save Woodworking
ON THE LEVEL
BY CHRISTOPHER SCHWARZ

10 Cutting Beads
LETTERS
FROM OUR READERS

14 Handsaw Tenon Jig
TRICKS OF THE TRADE
FROM OUR READERS

VIDEO ▶ Tricks-in-Action
Watch a video of one of our tricks at work.
popularwoodworking.com/tricks

16 Earlex HV 5000 Spray Station
TOOL TEST
BY THE EDITORS

ONLINE ▶ Tool Test Archives
We have lots of tool reviews on our web site, free.
popularwoodworking.com/tools

20 Brooke Smith
DESIGN MATTERS
BY GEORGE R. WALKER

22 Three-legged Turned Chair
ARTS & MYSTERIES
BY PETER FOLLANSBEE

24 Factory Cart Coffee Table
I CAN DO THAT
BY DREW DEPENNING

54 Optimize a Spray Gun
FLEXNER ON FINISHING
BY BOB FLEXNER

62 Glossary
TERMS OF THE TRADE
Woodworking's terminology can be overwhelming. Learn the terms used in this issue.

64 Chainsaw Massacre
END GRAIN
BY JOE ASNAULT



24



POPULAR
Woodworking
MAGAZINE

Number 185, October 2010. *Popular Woodworking Magazine* (ISSN 0884-8823, USPS 752-250) is published 7 times a year, February, April, June, August, October, November and December, which may include an occasional special, combined or expanded issue that may count as two issues, by F+W Media, Inc. Editorial and advertising offices are located at 4700 E. Galbraith Road, Cincinnati, Ohio 45236. Unsolicited manuscripts, photographs and artwork should include ample postage on a self-addressed, stamped envelope (SASE); otherwise they will not be returned. Subscription rates: A year's subscription (7 issues) is \$24.95; outside of the U.S. add \$7/year • Canada Publications Mail Agreement No. 40025316. Canadian return address: 2835 Kew Drive, Windsor, ON N8T 3B7 • Copyright 2010 by *Popular Woodworking Magazine*. Periodicals postage paid at Cincinnati, Ohio, and additional mailing offices. Postmaster: Send all address changes to *Popular Woodworking Magazine*, P.O. Box 420235, Palm Coast, FL 32142-0235 Canada GST Reg. # R122594716 • Produced and printed in the U.S.A.

Item #P410

Premier

FUSION

HOW CAN THE BEST GENERAL PURPOSE SAW BLADE GET EVEN BETTER?

Make It Available In Thin & Full Kerf Designs For Every Table & Chop Miter Saw!

Introducing the Premier Fusion saw blade in both Thin and Full Kerf design. Now woodworkers have a superior general purpose blade for both the table and chop miter saw in the shop and for the lower horsepower saw on the job site. The New Thin Kerf combines the advanced Premier Fusion features with a thinner kerf design to provide a flawless finish while reducing material waste, which makes it the ideal choice for lowered powered saws.

Freud's patent-pending Premier Fusion Saw Blade is the most technologically advanced blade on the market with a radical new "Fusion" tooth design that combines a double side grind with a 30 degree Hi-ATB to produce a glass-smooth, chip-free top and bottom surface while ripping and crosscutting.

The unique Fusion tooth design, combined with Freud-made TiCo™ Hi-Density Carbide, superior anti-vibration design and patented Perma-SHIELD® non-stick coating create the ultimate general purpose saw blade with flawless cutting performance.

Choose from four blades in the Full Kerf Premier Fusion series – 8", 10", 12" and 14" or try the new Thin Kerf 10" Premier Fusion. Use a Premier Fusion blade once and you'll be convinced.

Freud's Fusion Tooth Design vs. Others



To sign up for Freud's e-mail newsletter or to find a dealer near you visit or call:

www.freudtools.com
1-800-472-7307



freud®

Precisely the best.

C O N T R I B U T O R S

POPULAR Woodworking MAGAZINE



Bob Flexner
“Optimize a Spray Gun,”
page 54.

Bob Flexner has been a contributing editor to *Popular Woodworking Magazine* for more than a decade and is among the most respected experts on wood finishing and refinishing. He’s taught countless finishing classes, served as editor of the trade magazine for professional refinishers and written for more than a dozen magazines.

Bob recently completed the massive task of revising and updating all the columns he’s written for us over the years to develop a new book: “Flexner on Finishing” (Popular Woodworking Books). It’s a no-bull approach to the process and products of finishing, and a must-have for those interested in going beyond finishing basics.

▶ To read more about Bob’s new book, visit the *Woodworker’s BookShop* (WoodworkersBookShop.com) and type “Flexner” in the search bar.



Michael Dunbar
“Understand & Use a
Bowsaw,” page 34.

Michael Dunbar has been a chairmaker since 1971. He has written seven woodworking books and authored countless magazine articles, and he’s been featured in *The New York Times* and *The Wall Street Journal*. In 1980, he and his wife, Sue Dunbar, founded The Windsor Institute, a New Hampshire-based school that teaches all things Windsor (Mike has taught more than 3,000 people how to make a Windsor chair). At his web site, in addition to a list of classes and a gallery of his work, you’ll find his blog, which is on our list of “must reads.”

In addition to teaching at his school, Mike is working on a series of adventure novels for young adult readers (if you know any agents or publishers in that field, he’d love to hear from you).

▶ To read more about Mike and his school, visit thewindsorinstitute.com.



Marc Adams
“Veneer is the Future,”
page 38.

Marc Adams has been a professional woodworker for 30 years, during which he’s won numerous awards, worked with the U.S. government on woodworking-related issues, and been featured in many books and magazines. He is also the founder of North America’s largest woodworking school, the Marc Adams School of Woodworking. In addition to his work at the school, Marc presents at universities, woodworking guilds and trade shows, and trains the trainers for some well-known tool manufacturers.

While Marc works in many styles and teaches on a wide variety of woodworking topics, some of his most arresting work is in veneer and marquetry. His story in this issue is the first of a three-part series on working with veneer, which Marc sees as the future of furniture.

▶ To read more about Marc and his school, visit marcadams.com.

OCTOBER 2010, VOL. 30, NO. 5

popularwoodworking.com

EDITORIAL OFFICES 513-531-2690

PUBLISHER & GROUP EDITORIAL
DIRECTOR ■ Steve Shanesy
x11238, steve.shanesy@fwmedia.com

EDITOR ■ Christopher Schwarz
x11407, chris.schwarz@fwmedia.com

SENIOR ART DIRECTOR ■ Linda Watts
x11396, linda.watts@fwmedia.com

EXECUTIVE EDITOR ■ Robert W. Lang
x11327, robert.lang@fwmedia.com

SENIOR EDITOR ■ Glen D. Huey
x11293, glen.huey@fwmedia.com

MANAGING EDITOR ■ Megan Fitzpatrick
x11348, megan.fitzpatrick@fwmedia.com

ASSOCIATE EDITOR FOR THE WEB ■ Drew DePenning
x11008, drew.depenning@fwmedia.com

PHOTOGRAPHER ■ Al Parrish

F+W MEDIA, INC.

CHAIRMAN & CEO ■ David Nussbaum

CFO ■ James Ogle

PRESIDENT ■ Sara E. Domville

EXECUTIVE VICE PRESIDENT, eMEDIA ■ Chad Phelps

SENIOR VICE PRESIDENT, OPERATIONS ■ Phil Graham

IT DIRECTOR ■ Jim Kuster

VICE PRESIDENT, AUDIENCE DEVELOPMENT ■ Tim Langlitz

EVENTS DIRECTOR ■ Cory Smith

NEWSSTAND DIRECTOR ■ Susan Rose

PRODUCTION COORDINATOR ■ Vicki Whitford

ADVERTISING

ADVERTISING DIRECTOR ■ Don Schroder

331 N. Arch St., Allentown, PA 18104

TEL. 610-821-4425; FAX. 610-821-7884

d.schroder@verizon.net

ADVERTISING SALES COORDINATOR ■ Connie Kostrzewa

TEL. 715-445-4612 x13883

connie.kostrzewa@fwmedia.com

SUBSCRIPTION SERVICES: Subscription inquiries, orders and address changes can be made at popularwoodworking.com (click on “Customer Service”). Or by mail: *Popular Woodworking Magazine*, P.O. Box 420235, Palm Coast, FL 32142-0235. Or call 386-246-3369. Include your address with all inquiries. Allow 6 to 8 weeks for delivery.

NEWSSTAND DISTRIBUTION: Curtis Circulation Co., 730 River Road, New Milford, NJ 07646.

ATTENTION RETAILERS: To carry *Popular Woodworking Magazine* in your store, call 800-894-4656 or write Magazine Retail Sales, P.O. Box 5014, Iola, WI 54945-5014.

BACK ISSUES are available. Call 800-258-0929 for pricing or visit popularwoodworking.com. Send check or money order to: *Popular Woodworking Magazine* Back Issues, F+W Media Products, 700 E. State St., Iola, WI 54990. Please specify publication, month and year.

Copyright ©2010 by F+W Media, Inc. All rights reserved. *Popular Woodworking Magazine* is a registered trademark of F+W Media.



VROOM!...Power Up!

Apollo ramps up the turbine world!

Our TrueHVLV **Power Series** give you more power, more performance, and more value than ever before...

- **Model 1050VR**
New Precision + Power
22% more power in a 5-stage turbine
- **Model 1035**
New Power Series
12% more power in a 4-stage turbine
- **Model 835**
New Power Series
15% more power in a 3-stage turbine



888-900-4857 (HVLP) www.hvlp.com

LAST CHANCE: SIGN UP TO LEARN FROM TODAY'S BEST WOODWORKERS!

WOODWORKING In America 2010

The Ultimate Skill-Building Weekend

October
1 to 3, 2010
CINCINNATI, OHIO

Sharpen your hand- and power-tool skills at hands-on classes with Roy Underhill, Frank Klausz, Christopher Schwarz and others!

Compare tools and try before you buy at the Exhibitors' Marketplace, packed with 50+ top-tier toolmakers happy to answer your questions!

Classes are filling up fast. Register now at www.woodworkinginamerica.com



Brought to you by:

POPULAR
Woodworking
MAGAZINE

WOODCRAFT®

Popular Woodworking's
**Woodworker's
BookShop**



BY CHRISTOPHER SCHWARZ, EDITOR

How You Can Save Woodworking

Almost every week I get a message from a woodworker who is terrified that we are the last generation of people who will build furniture in our home workshops.

I'm not nearly as apocalyptic, but I do get queasy when I hear about the shuttering of another high-school shop class. Or when I see people buying disposable furniture that might last two years. And

to top things off, we all winced when Norm Abram announced he wasn't making any new episodes of "The New Yankee Workshop."

It does make you wonder: How will we inspire young people to take up the tools of our craft?

I think the solution is simple, something you can do now and that is free. Here it is: Start a

woodworking blog that chronicles what you build and how you work.

Blogging is a painless form of writing a diary, really. Blogging requires no technical skills – if you can write an e-mail you can write a blog. And, like I said, it costs nothing to start or maintain (I recommend you visit wordpress.com to get started).

How will this inspire future generations? Easy. Everything you write about woodworking is recorded by robots that index the Internet. In other words, everything in your blog will almost certainly be preserved forever in a form that is searchable by future generations.

So when some young homeowner is searching the Internet in 100 years because he or she wants to build some bookshelves to go next to a fireplace, there will be a wealth of information waiting there. Different

techniques, materials and finishes. And I think they will find not just how to build those shelves, but they will discover why they should build those shelves instead of buying them from some store that sells prefabricated termite barf.

After writing a blog for more than five years (blog.woodworking-magazine.com/blog/), I have already started seeing

my prophecy come true. And I also know that the words of the past can inspire future generations. For proof, I carry the below quotation with me in my wallet.

"I think that if I did not work with wood, my life would be a hollow emptiness. If I did not form and shape and build, what would I have done to leave

my mark in this world? My eyes have been filled with the endlessly changing patterns of the grains. I have felt the warmth of a thousand suns in my hands every day. I have smelled the rich, tangy odors of the freshly hewn chips. These are the things that have made my life so fine. These are the most precious things I can leave for you, my son."

— Jonas Wainwright
master carpenter
from a letter to his son, 1832

If you do start a blog and keep at it, send us a note – we just might link to it and make you famous. **PWM**

Christopher Schwarz



Customer Service

How can I contact customer service with questions regarding my subscription, including a lost or damaged issue? Visit popularwoodworking.com/customerservice. Or write to Popular Woodworking Magazine, P.O. Box 420235, Palm Coast, FL 32142-0235. Or, if you prefer the telephone, call 386-246-3369 and a customer service representative will be happy to help you.

When does my subscription expire?

The date of your subscription expiration appears on your magazine mailing label, above your name. The date indicates the last issue in your subscription.

Can I get back issues of Popular Woodworking and Woodworking Magazine?

Back issues are available while supplies last. Visit popularwoodworking.com/backissues. Or if you know the exact month and year of the issue you want, call our customer service department toll-free at 800-258-0929 to order.

What if I want more information about the projects and tools I read about in Popular Woodworking Magazine?

For all editorial questions, please write to Popular Woodworking Magazine, 4700 E. Galbraith Road, Cincinnati, OH 45236. Or e-mail popwood@fwmmedia.com.

Does Popular Woodworking Magazine offer group discounts?

Group discounts are available by special arrangement with the publisher. For more details, send an e-mail to Debbie.Paoletto@fwmmedia.com or call 531-533-2690 x11296.

Our Privacy Promise to You

We make portions of our customer list available to carefully screened companies that offer products and services we believe you may enjoy. If you do not want to receive offers and/or information, please let us know by contacting us at: List Manager, F+W Media, Inc., 4700 E. Galbraith Rd., Cincinnati, OH 45236

Safety Note

Safety is your responsibility. Manufacturers place safety devices on their equipment for a reason. In many photos you see in *Popular Woodworking Magazine*, these have been removed to provide clarity. In some cases we'll use an awkward body position so you can better see what's being demonstrated. Don't copy us. Think about each procedure you're going to perform beforehand.

Highly Recommended

Like most woodworkers, I have some great old Stanley planes with knobs and totes that look like dogmeat. Sure I could make some replacement knobs, but there is a faster solution.

Bill Rittner of Manchester, Conn., now makes shapely Stanley knobs and totes that have the look and feel of the 1870s handles. The knob has a bead at the base. And the tote is just perfect. There are no flat spots like on modern Stanleys. And the fit and finish of Rittner's work is superb. These look as good as the original rosewood knobs. A set costs about \$40. Contact him via e-mail at rbent.ct@gmail.com.

— Christopher Schwarz



PHOTO BY CHRISTOPHER SCHWARZ

The facts are hard to ignore.

Titebond® III outperforms polyurethane glues.

Reference Guide

Glue comparison

What woodworkers need to know!

	Titebond III	Polyurethane Glues
Higher Bond Strength	✓	✓
Exterior Use – Waterproof	✓	
Easy Water Cleanup	✓	
Much Safer To Use	✓	
Shorter Clamp Time	✓	
No Foam – Less Mess	✓	
Shorter Open Time	✓	✓
Doesn't Stain Skin	✓	✓
Bonds Most Materials	✓	
Bonds Oily / Exotic Woods	✓	
Lower Cost – Better Value	✓	
Longer Usable Shelf Life	✓	

Woodworking Handbook 2007
8 FL. OZ. (237 mL)



As the leader in wood glues, we want you to know the truth about polyurethane glue and woodworking. A straightforward comparison between Titebond® III Ultimate Wood Glue and polyurethane glue tells the story.

Titebond® III is THE ultimate choice for bonding wood to wood. Period.

For more information and a detailed comparison, please visit www.titebond.com/TBIIIvsPolyurethane

Made in the USA

For more information, go to PWFREEINFO.COM.

Cutting Beads

In the June 2010 issue (#183), the White Water Shaker table article showed a simple bead being cut by a moulding plane. Most of the tools I've seen commercially available these days are spokeshave-like beading tools. I'm sure you're familiar with the Lie-Nielsen and Veritas versions that allow you to change the blade for different profiles, etc.

I was wondering how you felt about different beading tools, and any particular favorites you have. The moulding plane in your article looks like a pleasure to use from the crisp edges and length of the tool (though it's a little hard to see from the photo). On the other hand, you'd need a lot of moulding planes with different profiles to match the versatility of one spokeshave-style beading tool. Again, pros/cons in your opinion would be appreciated, but where to buy good moulding planes would be equally helpful.

Aaron Moore
Fairport, New York

Aaron,
When it comes to beading planes vs. beaders (the spokeshave-style you mention), there is one major difference: The planes are slicing the wood and the beaders are scraping them. What that means from a practical standpoint is that the planes will result in better details when the iron is sharp and the tool is wielded correctly. But mistakes are costly.

With the scraping tools, you can't go too wrong, but you can't go for perfection, either. Scraped profiles are always a little more rustic-looking in my experience.

So I am not sure how to advise you. I use moulding planes whenever I can, but when faced with an odd profile, I will use a scratch stock or beader.

Christopher Schwarz, editor
P.S. Good new moulding planes are available from Clarke & Williams and M.S. Bickford.

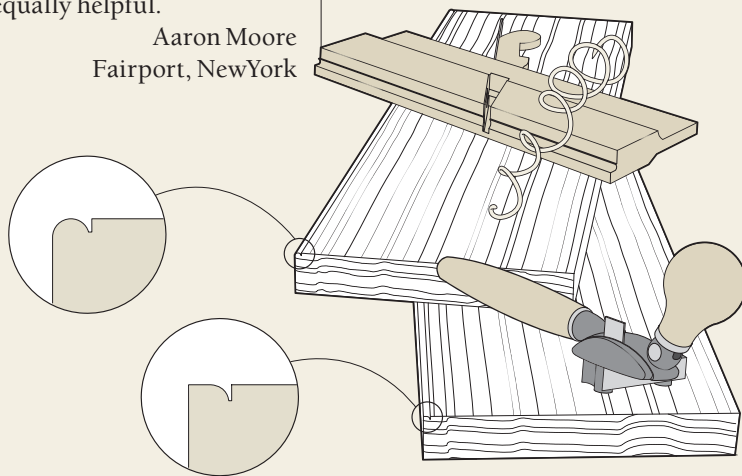

Eric,
This issue comes up more often than you might think. The problem is that the shellac, when cleaned in alcohol, is diluted with each cleaning. At the end of the job, when you feel the brush is clean, small amounts of highly thinned shellac remain embedded in the bristles. Here's a great tip I picked up from Bob Flexner. For the best results, clean your shellac brushes in a 50-50 mixture of water and household ammonia, followed by a final cleaning with dish soap and water.

I rinse my brushes a number of times with clean alcohol, then I follow Bob's advice. The next day, my brushes are soft and ready to use.

Glen D. Huey, senior editor

Frank Klausz's Method to Flatten Scraper Plane Soles

I read with great interest the June 2010 issue of *Popular Woodworking Magazine* (#183). David Charlesworth's article is an excellent instruction on how to sharpen a scraper plane blade; I do it the same way.

But I disagree on how to make the plane's sole flat. In four decades, I've tuned a lot of tools. Most of the bottoms need very little straightening. Do not use rough grits as he describes. I recommend to try #400-grit wet/dry sandpaper lubricated with WD-40. Most of the time you need only a few minutes' sanding and you are done. If needed, you can go to #220 grit then back to #400 grit. Finish with waxing the sole, or buff it with a buffing wheel and WR1-White Rouge.

You can see this method in use on my "Hand Tools" DVD.

Frank Klausz
Pluckemin, New Jersey

Should I Fit My Doors & Drawers In SketchUp?

Thank you for your new SketchUp video series (available in the "Shop Class" section at woodworkersbookshop.com).

I am new to woodworking and have what is probably a simple question but one that I just can't seem to let go.

How to Clean Shellac Brushes

I continue to use at every opportunity Senior Editor Glen D. Huey's finishing recipe: stain, shellac, glaze, shellac and topcoat. This means, of course, several cleanings of brushes in alcohol (those

used to apply the shellac), but the brushes always are stiff after they dry, as compared with those cleaned in mineral spirits. Can you suggest any remedies?

Eric Bolen
Wilmington, North Carolina

Big News From Forrest

4 New Blades For Discerning Woodworkers

Forrest sets the standard for excellence with these new top-quality blades:

- **Woodworker II 48-Tooth Blade** for general-purpose applications. Features a 20° face hook, a 25° bevel, and sharp points for clean cross-grain slicing and quiet, smooth cutting.

- **"Signature Line" Chop Master** for quiet, precise cutting and less splintering. Features 90 teeth, a -5° hook to control the feed rate, and re-designed angles with 10" or 12" diameters and 5/8" or 1" center holes.

- **2-Piece & 4-Piece Finger Joint Sets** with reversible, interlocking 8" blades. Ideal for rabbets and grooves. Blades have 24 teeth and standard 5/8" bore. Reversible for 3/16" and 5/16" cuts or 1/4" and 3/8" cuts.

- **Thin Kerf Dados** for clean cutting of 3/16" to 1/4" grooves in thin plywood and man-made materials. Available in two-piece and three-piece sets for table or radial arm saws.



Our blades are U.S.A.-manufactured and have a 30-day, money-back guarantee. Custom sizes available. Order from Forrest dealers or retailers, by going online, or by calling us directly.

FORREST
The First Choice of Serious
Woodworkers Since 1946

www.ForrestBlades.com 1-800-733-7111 (In NJ, call 973-473-5236)

© 2010 Forrest Manufacturing Code PW

For more information, go to PWFREEINFO.COM.

Request a **FREE** catalog!



Functional Hardware



Abrasives & Adhesives



Shop Supplies & Tools



Also see:

- Locks • Lighting • Bar Rail
- Fasteners • Kitchen organizers
- Shelf brackets and much more...

Request a **FREE** catalog - Promotion #885



Woodworker's Hardware

woodworkershardware.com
or 1-800-383-0130

For more information, go to PWFREEINFO.COM.



Epilog Laser and PhotoLaser Plus



Systems starting at \$7,995!

MADE IN USA

We've combined Epilog Laser's unbeatable engraving quality with CADlink's powerful laser photo processing software, PhotoLaser Plus.

View an online demonstration of PhotoLaser Plus and see how it will provide stunning photo engraving results at www.epiloglaser.com/popwood.htm.

sales@epiloglaser.com • 888-437-4564

For more information, go to PWFREEINFO.COM.

CONTINUED FROM PAGE 10

How do you adjust for real-world workable tolerances of wood, clearances for hinges, drawer openings etc? One of the “take home” messages throughout the SketchUp series is to limit drawing and use existing parts of the drawing to make other parts so that they are exactly sized. This exact sizing does not seem practical in the real world. My concern comes from when I go and replicate individual components from the plans made in SketchUp only to have things be a little too big. Ideas? Thoughts?

Drew Sanderson
Rush, New York

Drew,

Good question. My first thought is that a little too big is a good thing. It is certainly easier to deal with than a little too small. We discussed this at some length in the Autumn 2008 Woodworking Magazine (Issue 11).

My preference is to make drawer fronts and doors the exact size of the opening, then adjust them to fit the gaps I want. The exact size of the gaps will vary depending on several factors including the species and cut of wood, season of the year and sizes of the parts. I aim for the smallest workable gap that is consistent around the perimeter of the opening. By starting with a too-tight exact fit, I have built forgiveness into the project if my openings aren't a perfect size and shape. Taking a bit off doesn't take long, and no one will know or care if my door stiles are 2¹⁵/₁₆" instead of 3".

It is possible (and there are people who work this way) to figure the size of the gaps before the fact and shoot for perfection. While I think this takes too much time and introduces too many risks, you can easily do this in SketchUp by making use of the offset or scale tools. Make a rectangle the exact size of the opening as a reference, then make another one set in all around. This will, of course, take more time, and it also makes dimensioning and reading the finished drawings more difficult.

Robert Lang, executive editor

“Never write a letter while you are angry.”

— Chinese proverb

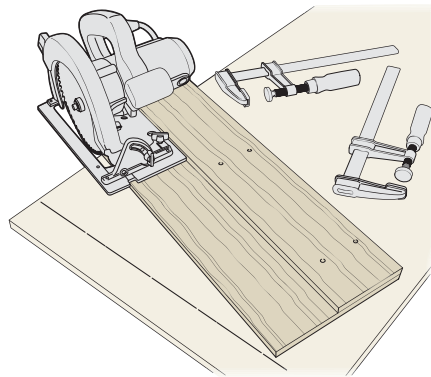

A Simpler Circ Saw Solution

In response to the winning “Trick of the Trade” from the August issue (#184), several readers suggested an alternate method for making long straight cuts with a circular saw.

In fact, the jig suggested is the one we use in our shop—but it does take up more space than Sam Smith's solution.

Rip a straightedge from a piece of solid stock and attach it to a 1/4"-thick piece of plywood that is slightly wider than the sum of the width of the straightedge and the saw's baseplate. Now place the saw's baseplate against the straightedge and make a cut. That cut results in a jig that matches the saw perfectly.

To use the jig, place the cut edge of the plywood on your cutline, clamp the jig in place, then make the cut.

Megan Fitzpatrick, managing editor

Lumber Purchase Advice

I need guidance on purchasing lumber for your Chester County Chest (“Fine Furniture for a Lifetime”). Roughly how many board feet of primary wood do I need? Secondary wood is no problem. I can calculate from finished dimensions—but how much waste do you normally factor in.

Eric Watson
Huntsville, Texas

Eric,
Take the overall dimensions for the sides, top and front—in this case the sides are 23" x 60" (x2), the top is 23" x 42" and the front is 42" x 60". Add those results, increase the amount by 25 percent and divide the total by 144. That's a very rough estimate of primary wood; in this case, 54 board feet.

However, I order more than the required amount so that I have enough to pick and choose boards for grain matches, and to have enough on hand in case I make a mistake. For this piece, I would order 70-75 bf. You should have material left over—but that's always good for small boxes or other projects.

Glen D. Huey, senior editor

The Future of Table Saws

I read with interest your editorial on the future of table saws (Issue #184). While I completely agree that the operator is responsible for his or her safe operation of a tool and am shocked by the court verdict, I have to say that I rid myself of my table saw about a year ago.

I found the table saw noisy, dusty, a chore to maintain and the highest safety risk in my shop. I did a six-month trial and stopped using it, relying on my band saw, sliding compound miter saw, router and circular saw to do the things I had done on the table saw. After becoming convinced I could live without the table saw, I “loaned” it to my father-in-law with no intention of getting it back. I have not missed it. In fact, I enjoy doing the majority of my cuts on the band saw. I feel more in control of the wood I am cutting, and it's much safer than pushing a piece into a table saw. **PWM**

Keith Beyer
La Crosse, Wisconsin

Go Online FOR MORE ...

Letters and Comments

At popularwoodworking.com/letters you'll find reader questions and comments, as well as our editors' responses.

We want to hear from you.

Popular Woodworking Magazine welcomes comments from readers. Published correspondence may be edited for length or style. All correspondence becomes the property of Popular Woodworking Magazine.

Send your questions and comments via e-mail to popwood@fwmedia.com, or by mail to:

Letters, Popular Woodworking Magazine
4700 E. Galbraith Rd.
Cincinnati, OH 45236

DadoMax™

Make precise no-rattle dados with a router instead of a cumbersome dado blade with the new improved DadoMax™. Complete details and instructions are available for you at our website, www.woodline.com.



Original price \$109
NOW ONLY \$99
 through Sept, 2010!

Bowl & Tray Templates and Bits



With Woodline USA bowl and tray bits and pattern templates you can make attractive wooden trays that are both decorative and functional. Each 12" mdf template is \$16.95. To see full instructions and all shapes and sets, visit www.woodline.com.

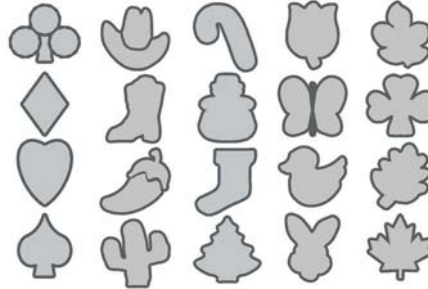

20+ styles to choose from



WL-1386B WL-COLEXT
 YOUR CHOICE \$25 each



Here's a small sample of our lathe tools. Many more are available.

KEY	PART #	DESCRIPTION	PRICE
A	WL-CH100	3/4" Roughing Gouge	\$39.99
B	WL-CH600	1/2" Deep Bowl Gouge	46.00
C	WL-CH120	1" Roughing Gouge	55.00
D	WL-CH606	3/4" Curved Scraper	35.00
E	WL-CH303	3/8" Captive Tool	42.00
F	WL-CH404	1/2" Captive Tool	42.00
G	WL-CH202	3/4" Diamond Parting Tool	34.99
H	WL-CH101	1/2" Diamond Parting Tool	29.99

Wood Gear Clock now available in Mission Style



Complete kits including Pin Router, templates, hardware & gear wood only \$249!

Woodline USA is the official manufacturer of Maloof router bits!



These bits feature a unique tapered rabbet with tapered bearings developed specifically for Sam Maloof to make the fabulous joints of the Maloof chair. All have a 1" diameter and 5/8" cutting depth.

PART #	SLOPE	PRICE
WL-6220	5° 2 pc Set	\$75.00
WL-6221	3° 2 pc Set	75.00
WL-6220	0° Single Bit	35.00



1-800-472-6950

visit www.woodline.com for even more specials!

EDITED BY KARI HULTMAN

THE WINNER:

Handsaw Tenon Jig

This simple jig enables you to cut accurate tenons and slice very thin pieces. I use a flush-cut saw because it has no set to its teeth and, therefore, won't damage the jig. Plus it leaves a smooth surface.

The only requirements for building the jig are a flat baseboard, such as Baltic birch plywood, and guide blocks of equal thickness that are screwed to the baseboard at a 90° angle. I use playing cards to adjust the height of the workpiece.

Slide your workpiece against the 90° guide blocks, lay a separate guide block on top of the workpiece, align it with the shoulder mark, then clamp it to the jig. Saw the cheek and shoulder, flip the piece over, and cut the other side.

This produces a perfectly centered and parallel tenon.

The jig and card shims give you precise control over the thickness of the offcut. So, you can cut very thin pieces for: bookmatching pieces for a small lid; shimming a loose joint; cutting key slots in mitered corners; making Dutchman patches; and creating small projects such as bookmarks, wooden cards and Christmas ornaments.

You can cut longer slices if you add a guide block on the opposite side of the workpiece. Then, you have your own custom micro veneer mill!

Steve Branam
Ayer, Massachusetts
closegrain.com

Plane Blade Cambering Jig

Here's an easy way to grind a camber on a slotted plane iron. Attach the metal bar, screw and knob that come with most manufactured featherboards to the bevel side of the iron, making sure the bar is centered.

These bars are designed to expand in a miter slot, so as you tighten the screw, the center of the bar will bow slightly. The more you tighten, the more it will bow. Use this as a guide against the bottom edge of your grinder's tool rest.

You can make your own jig from a scrap of hardwood, measuring 3/4" x 1" x 6". Drill a countersunk hole in the middle of the scrap, and two holes 1" from both ends, so the wood doesn't split. Cut a center slot that connects all three holes. Use a machine screw that fits snugly in the center hole and attach it to the plane iron with a washer and knob or wing nut. As you tighten the screw, the wood will arc in the middle. The more you tighten, the bigger the camber.

If you want a repeatable camber, use a band saw to cut an arc on a piece of wood, sand it smooth, then attach it to the iron.

Chad Bennett
Mission Viejo, California

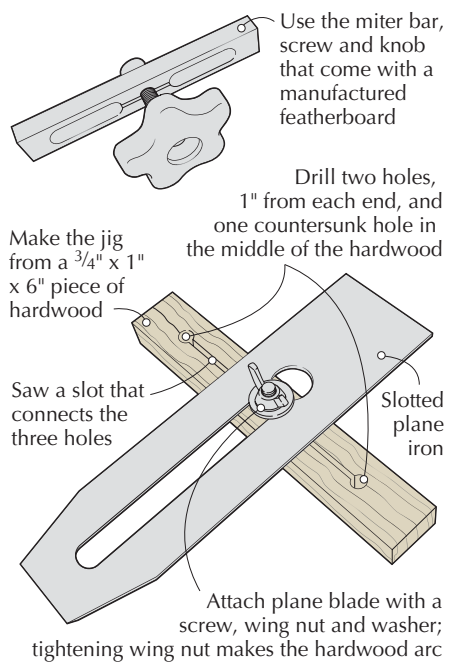
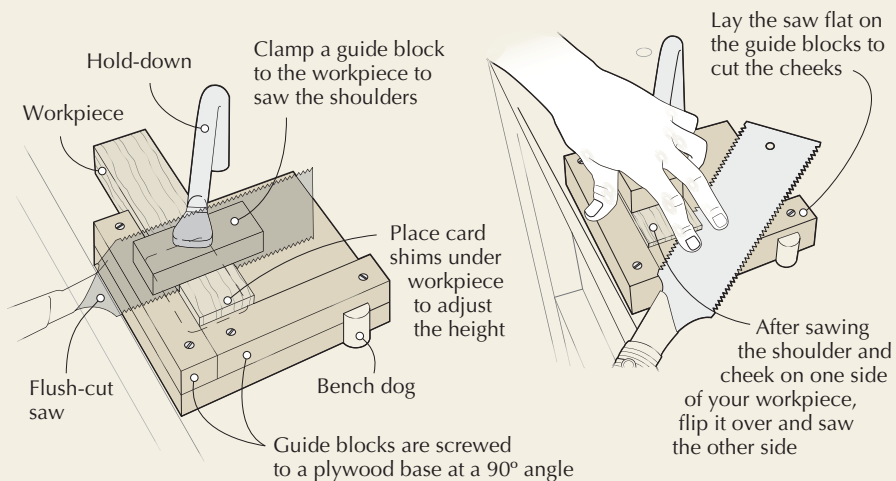

Straightedge with a Grip

When using my 3' straightedge for cutting templates, cardboard, matboard or veneer, the unruly beast had a tendency to slip. To resolve this problem, I added a strip of high-friction tape to the back of my straightedge (Lee Valley #99K34.01).

I applied the tape about four years ago.

It still has a good grip and doesn't leave residue on workpieces.

If you've ever ruined expensive veneer or matboard due to a slipped straightedge, you'll want to try this.

Craig Bentzley
Chalfont, Pennsylvania

Spring-loaded Stop Block

Commercial stop blocks for miter saws are located on the left side of the blade, which makes it difficult to cut identical, short pieces.

To overcome this, I made a spring-loaded stop block that can be placed on either side of the blade. It consists of two parts: a stationary block that is clamped to the miter saw fence and a swing block that can be flipped up to prevent binding when the stock is cut.

The swing block is attached to the stationary block with a machine screw, compression spring, washer and nut.

When the nut is tightened, the compression spring holds the swing block securely in the up and down positions.

Clamp the jig in place according to the length of piece you need. Before you cut,

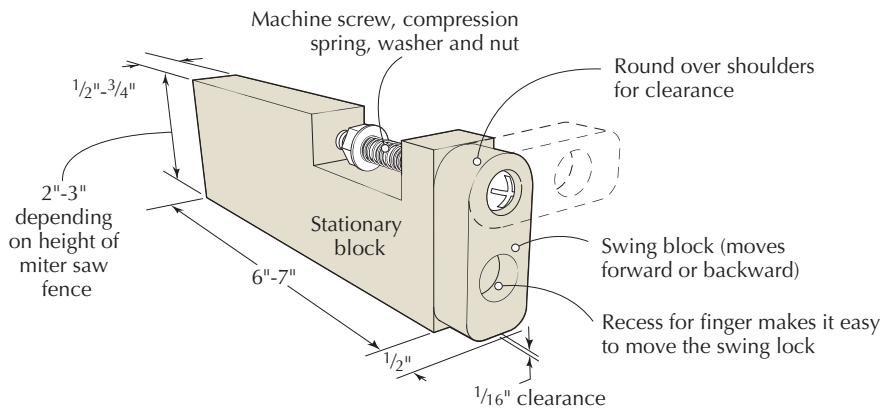

lift the swing block out of the way so the offcut doesn't bind.

This jig can also be used with a crosscut sled on a table saw.

Charles Mak
Calgary, Alberta

Easy-mix Epoxy – Treat it like Icing

I often use epoxy in woodworking and making repairs. In the past, I mixed the components in a paper cup or on a piece of cardboard, then applied the epoxy with a mixing stick or putty knife. Frequently, the epoxy ended up in unintended places, including on my clothes and hands.

I was watching the chef on a cooking show use a pastry bag, and came up with a better way to mix epoxy – with a clear plastic sandwich bag.

I pour the two components (and filler or dye) into a sandwich bag and twist the bag loosely until the material is confined to one corner. I knead the “bubble” of components with my fingers until completely

mixed. Then, I cut a tiny piece off the corner of the bag with a pair of scissors to make a small “pastry” bag.

By gently squeezing the material through the hole, the desired amount of epoxy can be applied exactly where I want it. It works great for filling cracks, splits and knotholes in recycled lumber. I place the tip of the bag right into the crack or split and fill the hole from the bottom up. The surrounding area (and my fingers!) stays clean, and I simply throw the bag away when I am done.

Tom Hargrove
Palatine, Illinois

On Your Mark

I have always had problems cutting accurately to a line with my table saw. The cutline is on top of the wood, making it difficult to line up with the saw blade's teeth. My solution is simple. Lay a 3/4" x 3/4" x 17" piece of high-quality plywood or hardwood along the teeth of the saw and across the workpiece. Shift the board and table saw fence until the cutline is aligned with the straightedge. To work properly, the straightedge must touch the blade's teeth at both the back and front the blade. Now, table saw cuts are a piece of cake.

Dan Urban
Glen Ellyn, Illinois

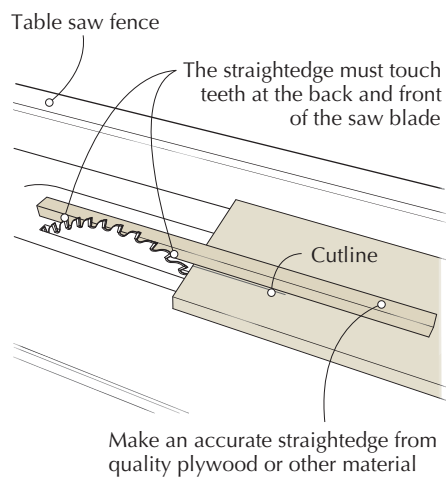

Go Online FOR MORE ...

You'll find links to all these online extras at:

► popularwoodworking.com/oct10

VIDEO: *Tricks-in-Action* shows you a free video of one of this issue's tricks in use. Watch the "Plane Blade Cambering Jig," filmed by Tricks Editor Kari Hultman in her shop.

WEB SITE: Visit the new *Tricks of the Trade* page online.

BLOG: Tricks editor Kari Hultman writes about woodworking on her blog, *The Village Carpenter*.

IN OUR STORE: Get "601 Woodshop Tips & Tricks," by Graham McCulloch.

All of our products are available online at:

► WoodworkersBookShop.com

Cash and prizes for your tricks and tips!

Each issue we publish useful woodworking tips from our readers. Next issue's winner receives a \$250 gift certificate from Lee Valley Tools, good for any item in the catalog or on the web site (leevalley.com). (The tools pictured below are for illustration only and are not part of the prize.)

Runners-up each receive a check for \$50 to \$100. When submitting a trick, include your mailing address and phone number. If your trick is selected, an editor will need to contact you. All entries become the property of *Popular Woodworking Magazine*. Send your trick by e-mail to popwoodtricks@fwmedia.com, or mail it to Tricks of the Trade, *Popular Woodworking Magazine*, 4700 E. Galbraith Rd., Cincinnati, OH 45236.



BY THE EDITORS

Affordable HVLP

Improve your game with a low-cost spray finishing system from Earlex.

Finishing is often the “make it, or break it” part of a project. To improve your finishing abilities, it’s time to stop relying on wipe-on and brush-on finishes and get busy spraying. When it comes to spray finishing, HVLP is king.

Earlex has made High-Volume Low-Pressure spraying affordable for most woodworkers. At less than \$300, money should no longer be a barrier. The Earlex HV5000 Spray Station has a two-stage turbine, and the system works.

If you’ve studied HVLP, you know that the more stages in your system, the better the power and the better the atomization of your product. However, each stage adds to your out-of-pocket expense, so how many stages do you really need? Besides, you can increase your atomization and lay down a smoother coat of finish by slightly thinning your shellac, varnish or lacquer – dye and stain are already thin enough.

The spray gun included with the Earlex system is a bleeder-type gun; whenever the



The whole nine yards. The Earlex HV5000 Spray Station is ready to use right out of the box. The setup includes a two-stage turbine, a spray gun and a 13' length of hose. There’s nothing to add but the finish.



Adjustment at your fingertips. You can adjust the Earlex 5000 spray gun for fan width, fan direction and fluid delivery – there’s little else you need to manipulate.

turbine is on, air blows. Supplied with the gun is a 1-quart Teflon-coated cup and a 0.08"-diameter fluid tip and needle. (Additional tips and needles – 0.04", 0.06" and 0.10" – are available.) The spray gun has all the adjustments found with higher-cost systems, except the ability to control the airflow – it’s either on or it’s off.

You can dial in the amount of fluid coming into the tip by turning the knob at the back of the handle. The fan spray, adjustable from 1" to 12" in width by turning the air cap ring, was a bit “dry” near the middle of the spray pattern when I first used the Earlex system, so I adjusted my lapping pattern by tightening the overlap area. And like the spray patterns found on most HVLP systems, Earlex HV5000 can adjust to vertical and horizontal fans, or you can select a round jet-spray pattern that is useful for getting into tight spaces.

To make this system easy to use, Earlex included onboard storage for the cord and hose; the cord is 5½' in length and wraps around the base of the unit, while the hose is 13' long and stores just behind the blue plastic housing. There’s also an area on top of the turbine to hold the gun when it’s not in use.

The Earlex HV5000 system is perfect for the woodworker who wants to finish using HVLP but doesn’t want the cost of entry to get out of hand.

—Glen D. Huey

CONTINUED ON PAGE 18

PHOTOS BY AL PARRISH

Earlex HV5000 Spray Station

Earlex ■ Earlex.com or 888-783-2612

Street price ■ \$299

► For more information on HVLP, visit popularwoodworking.com/oct10.

Price correct at time of publication.

10 YEARS of Popular Woodworking in One Small Package

With 69 issues of *Popular Woodworking*, this CD is packed with thousands of pages of pure woodworking information – but it's easy to zero in on what you need with the simple-to-use search function – or browse through individual issues.

You'll find a huge range of project plans – from contemporary to period classics – expert technique instruction, tool reviews, shop tips and tricks and more.

- 35+ designs for bookcases and storage
- 400+ pages of plans, step-by-step instructions and drawings
- Essential technique instruction
- And much more – 5,500+ pages in all!

Order 'Popular Woodworking 2000-2009' now – visit WoodworkersBookShop.com and search '2000-2009' or call 800-258-0929.

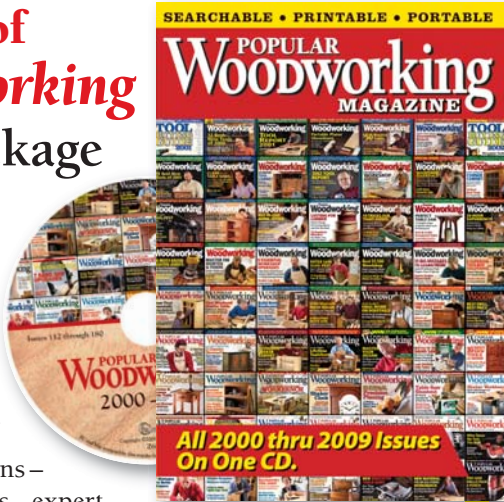

ISBN: 978-1-4403-0220-0 • #Z6070

\$109.95 RETAIL
Check Online for Limited-time SPECIAL PRICE

A Decade's Worth of Pure Woodworking Information

STEVE WALL LUMBER CO.

Quality Hardwoods and Woodworking machinery For The Craftsman and Educational Institutions

- OLIVER MACHINERY DEALER
- HARDWOOD PLYWOOD
- CUSTOM RAISED PANEL DOORS
- CUSTOM PLANK HRDWD FLOORING
- THIN CRAFTWOOD
- EXOTIC LUMBER

Ash	4/4	Select	\$ 2.60	\$ 94.00
Basswood	4/4	Select	\$ 1.95	\$ 80.00
Birch	4/4	Select	\$ 3.55	\$ 108.00
Butternut	4/4	1C	\$ 2.95	\$ 88.00
Cherry	4/4	Select	\$ 4.90	\$ 117.00
Hickory - Pecan	4/4	Select	\$ 3.00	\$ 100.00
Mahogany (Genuine) ..	4/4	Select	\$ 4.70	\$ 112.00
Maple (Hard)	4/4	Select	\$ 3.45	\$ 108.00
Maple (Soft)	4/4	Select	\$ 2.50	\$ 88.00
Poplar	4/4	Select	\$ 1.80	\$ 78.00
Red Oak	4/4	Select	\$ 2.70	\$ 96.00
Walnut	4/4	Select	\$ 4.90	\$ 115.00
White Oak	4/4	Select	\$ 2.70	\$ 96.00
Cedar (Aromatic Red) ..	4/4	1C+Btr.	\$ 1.80	\$ 78.00
Cypress	4/4	Select	\$ 2.60	\$ 90.00
White Pine	4/4	F.G.	\$ 1.25	\$ 70.00
Yellow Pine	4/4	Clear	\$ 2.30	\$ 82.00

**UPS
Specials**

SEE OUR CATALOG ON THE WEB!

Above prices are for 100' quantities of kilndried rough lumber sold by the Bd. Ft. FOB Mayodan, NC. Call for quantity discounts. Other sizes and grades available. Above prices are 20 bd. ft. bundles of clear kilndriedlumber 3'-10" wide x 3'-5" long (Random widths & lengths) Surfaced 2 sides or rough. Delivered UPS prepaid in the Continental U.S.

STEVE H. WALL LUMBER CO.

BOX 287
MAYODAN, N.C. 27027
336-427-0637
1-800-633-4062
FAX 336-427-7588

Email: wood@walllumber.com
Website: www.walllumber.com

Send \$1.00 For Lumber Catalog
Prices Subject to Change Without Notice

For more information, go to PWFREEINFO.COM.



With over 30 years of experience in producing lumber dryers you can count on EIP's dependability and simplicity.



We offer four models ranging from 800 BF to 10,000 BF



Ebac Industrial Products Inc
700 Thimble Shoals Blvd, Suite 109, Newport News, VA 23606-2575
Tel 757 873 6800 Fax 757 873 3632
Toll Free 1-800-433-9011 www.ebacusa.com

For more information, go to PWFREEINFO.COM.

BUILD IT TOUGH.



High strength with a shorter clamp time along with no dyes for a natural finish makes Gorilla Wood Glue ideal for your woodworking and building projects.

FOR THE TOUGHEST JOBS ON PLANET EARTH®



1-800-966-3458 Made in U.S.A.

© 2010 Gorilla Glue Company

For more information, go to PWFREEINFO.COM.

CONTINUED FROM PAGE 16

Karl Holtey's No. 982 Smoothing Plane

Since the 1980s, planemaker Karl Holtey has been an innovator in the world of tool-making. He has set the bar for the level of fit and finish a tool can achieve. And his No. 98 plane sparked the revolution in bevel-up planes.

So when I was offered the opportunity to borrow his follow-up to the No. 98—the No. 982—I jumped at the chance.

The No. 982 looks a lot like his No. 98, but there are major functional differences. The No. 982 is a bevel-down tool with the

iron pitched at 55°. The adjuster is a new design of Holtey's, and it is the most precise Norris-style adjuster I have ever used. Plus the plane has more mass, which I find a benefit in a smoothing plane.

I have used a fair number of Holtey planes during the last 10 years, yet I am always surprised at how perfect all the details of his tools are. They are often compared to jewelry, though I find that a bit inaccurate because these are real tools and not just for decoration.

During my time with the No. 982 I rode it hard building several pieces of furniture, then spent a day simply using it on the nastiest pieces of wood I could find.

No plane is infallible, but the No. 982 performed as well or better than every other plane in our shop (including a few other high-priced loaners).

If the No. 982 has one weak point, it's the way the rear tote is attached—a single fastener from below. When using this tool



and two examples of the No. 98, I found their totes would come loose in time.

Few can afford a supertool such as this, yet we all benefit from Holtey's influence as a toolmaker. His planes are the pinnacle of craftsmanship in my opinion—something we and toolmakers should aspire to.

— Christopher Schwarz

Karl Holtey No. 982

Holtey Classic Handplanes

■ holteyplanes.com or 44 [0]1549 402500

Street price ■ £6,800 (base price)

▶ Read our test-drive of many supertools from 2008 at popularwoodworking.com/oct10.

Price correct at time of publication.

Not Just for the Jobsite

Our shop sound system was on its last leg when the Bosch Power Box 360S (PB360S) arrived. We pulled the sound system from its box and fired it up. It's impressive.

The five speakers and lone subwoofer pump out great sound, but we quickly realized that other Power Box features make this “tool” a shop necessity.

With the PB360S plugged into a standard 110-volt electrical outlet, the tunes play on as the system itself acts as a charger for Bosch 14.4v or 18v Lithium-ion batteries, including all SlimPack and FatPack

designs. Also, if you lose power, chuck either of the battery designs into the Power Box, and you're up and running again.

The built-in four-way power outlet is killer. Plug in and operate small tools or other battery chargers. (Bosch 12v batteries don't play nice with the Power Box, but plug your charger into one of the onboard outlets and you can charge them, too.)

The PB360S has a weather-sealed digital media bay. (Big deal, it's inside the shop.) The bay, however, is also a dust-free zone, and that means your digital media player or SD memory cards and USB drives that hold your digital media files, all of which have connections in the bay, gather no dust. In the woodshop, that's gold.

The Power Box, with an onboard 12v DC (car charger) outlet, is great for charging cell phones as you're working in the shop. And an aluminum and rubber roll cage that's almost indestructible encases and protects the unit.



An upgraded Power Box (PB360D) has all the features of its little brother, plus its outlets are ground-fault circuits (GFCI), and the system has satellite radio capabilities. Of course, these extras come at an increased price. **PWM** — GH

Power Box 360S

Bosch ■ boschtools.com or 877-267-2499

Street price ■ \$209

▶ See the Power Box survive being tossed onto a parking lot at popularwoodworking.com/oct10.

Price correct at time of publication.

MORTISE CHISELS \$65 each
Made in Maine, USA



ORDER DIRECT:
800-327-2520
www.lie-nielsen.com

Lie-Nielsen
TOOLWORKS®
INC.

For more information, go to PWFREEINFO.COM.

Walking the talk.

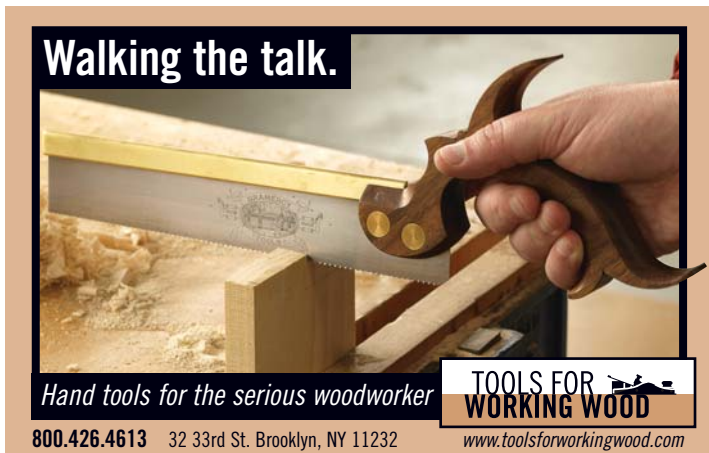

Hand tools for the serious woodworker

TOOLS FOR WORKING WOOD

800.426.4613 32 33rd St. Brooklyn, NY 11232
www.toolsforworkingwood.com

For more information, go to PWFREEINFO.COM.

TURN YOUR VAC INTO
A HOT ROD



U.S. Pat. # 7,282,074
E.U. Pat. Pend.

Oneida Air Systems

Vacuum Not Included.

Made in USA

The Dust Deputy's cyclonic action eliminates clogged filters for maximum vacuum performance. Dust can clog filters almost immediately. Our patented award-winning design retrofits easily to any shop vacuum and removes over 99% of dust.

Dust Deputy

Order Online at oneida-air.com Call for your FREE catalog! 800.732.4065

Oneida Air Systems

For more information, go to PWFREEINFO.COM.

Do Your Tools Cut It?

Your Long-Term Solution for Carving, Shaping, Cutting & Sanding.

- CUSTOM WOODWORKING
- FURNITURE & RAILINGS
- DIY PROJECTS
- CARVINGS LARGE OR SMALL

Shop Kutzall Direct
www.KutzallDirect.com



Reduce Your Work by 80% or More!
Easy to control, remarkable durability, and first-class performance. Let the tools do the work while you take the credit.....in far less time.

info@kutzalldirect.com
Phone: (810) 765-1000

KUTZALL®

For more information, go to PWFREEINFO.COM.

WOODCRAFT®

For A Free Catalog Or To Find Your Local Woodcraft Store, Visit woodcraft.com Or Call 800-225-1153.

Put Power In Its Place With A SafetyGate™ Professional

With a SafetyGate™ Professional, you won't need to worry about a dangerous restart after a power interruption.

SafetyGate™ Professional

- Patented Technology "Senses" That A Tool Is Still "On"
- Yellow LED Light Gives Visual Warning
- SafetyGate™ Stops Electricity Flow To Tool
- Turn tool "Off", Then "On" To Restore Power



10PW10Q

QUALITY WOODWORKING TOOLS • SUPPLIES • ADVICE®

For more information, go to PWFREEINFO.COM.

BY GEORGE R. WALKER

Brooke Smith

A visit to the shop of a designer & craftsman.

Creativity is a slippery thing. A lucky few are born with a creative streak that seems to flower without effort. Others (most of us) have to work at it to unlock our creative potential. Rarest of all is that bird that combines generous natural gifts and hard work.

Words like “artist” and “master” come to mind when describing furniture builder Brooke Smith of Columbus, Ohio. His small one-man studio turns out exquisite furniture that spans a broad range. I liken Brooke to a classically trained violinist who’s comfortable playing Bach, rock or bluegrass. His work encompasses corporate boardroom tables, high-style period reproductions and one-off modern studio pieces. Craftsmanship and attention to detail are first-rate, but the thing that most stands out is his talented designer’s eye.



Reeds. Here, Smith carves reeds on a turned leg.



Sheraton-inspired. Brooke Smith’s masterful interpretation of a traditional form expresses classic design features in a new way.

A Wide Array of Outstanding Work

Take a look at a sampling of Brooke’s work. This Sheraton chest (above) is his answer for a client who wanted a traditional piece but elevated up off the floor. If you didn’t know better you might call it a Federal highboy (there was no such form). It’s inspired by a chest from the shop of Thomas Seymour, an early 19th-century Boston cabinetmaker; one senses that Thomas would nod in approval. The dining table shown at right is a nice example of Brooke’s work in a modern style with restrained inlays accentuating each corner. The walnut secretary, shown at above right, is a wonderful display of Brooke’s carving talent. This is his own interpretation built around a traditional form, incorporating classically carved elements

showing a mastery working in a traditional style.

Recipe for a Talented Builder

Brooke shared with me his creative journey. It took some unusual twists that combined to make him the accomplished artisan he is today. Although he had some generational woodworking family lore, Brooke’s first impulses drew him down an artistic path.

He attended the Columbus College of Art and Design and earned a bachelor’s degree in illustrative design. Shortly after graduating, he found work at a museum working with an exhibition designer, where he learned how to showcase fine art.

His creative journey took a fortunate twist when he found work at a framing



studio specializing in high-end frames for the fine art market. There he had a chance to try his hand at wood carving and found a new, exciting medium to explore in addition to his love of painting. These were expensive, sometimes heavily carved frames, often overlaid with gold leaf. He spent four years as a professional carver, becoming fluent in creating the classical ornament associated with carved mouldings and frames. At one point Brooke was called on to carve a pair of massive mahogany frames to house murals for the statehouse. Not your average picture frame, they measured 10½' by 13½' and weighed in at more than 450 pounds each.

The desire to go beyond carving frames and begin building furniture led Brooke to enroll in the furniture-making program at the University of Rio Grande. Here he learned solid construction skills to provide a base for his creative energy. Today Brooke builds furniture for an eclectic group of loyal clients in the Columbus area.

Bringing Creativity to the Client

We spent time in his crowded but efficient shop discussing the creative process.

Brooke works closely with customers,

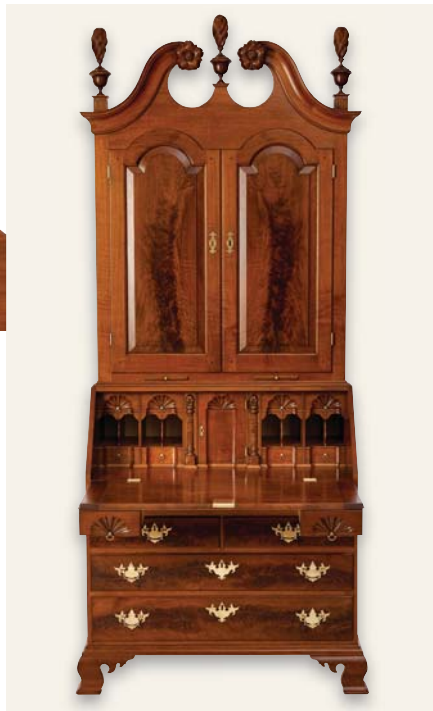

Traditional design. This walnut secretary is a tour de force showcasing Brooke's skill as an artisan and his mastery of working in a traditional design language. Notice the figured wood in the carved columns in the detail of the walnut desk interior. Carved rosettes and finials grace the pediment.

often visiting them at their homes numerous times while working up a design. More than collecting functional requirements, the visits are about getting a feeling for the personality of the interior setting and about building a relationship with the clients. One can sense that Brooke really considers clients as friends and views building something to grace their homes a privilege.

Rough sketches are taken from the initial visit and developed into a series of drawings, often four or five, to present a number of options to the client. Working through a series of design ideas helps both Brooke and his client find what they are after. These preliminary drawings helps him gain a better idea of what they like and dislike, paving the way to a final design.

A Tip from Brooke's Notebook

Once he's close to a final concept, Brooke takes an extra step to help the client visualize how the piece will look. He uses watercolors to color in the pencil drawing and give a sense of how the wood tones will bring



the piece alive. He finds it helps them picture the finished work. This seemingly small detail can help cement a decision and allow work to go forward.

After seeing his drawings, I immediately dropped by an art-supply store and picked up an assortment of markers in earth tones, burnt sienna, raw umber, amber and mahogany. Regardless of whether your client is a discerning art collector or your better half, this is a great tip to help sort through the creative process and finalize a design.

I finished my interview asking this talented builder a few quick questions: Favorite wood? Walnut. Favorite finish? Shellac, brushed on and rubbed out. Favorite tools? Without hesitation and spoken like a true designer, he held up his hands and said, "These hands and eyes." **PWM**

George is the author of the DVDs "Unlocking the Secrets of Traditional Design" and "Unlocking the Secrets of Design: Mouldings" both from Lie-Nielsen Toolworks (lie-nielsen.com).

Go Online FOR MORE ...

You'll find links to all these online extras at:

► popularwoodworking.com/oct10

BLOG: George R. Walker writes three times a week on the *Design Matters* blog.

WEB SITE: See more of Smith's work at his web site.

IN OUR STORE: George R. Walker's DVDs.

All of our products are available online at:

► WoodworkersBookShop.com

About This Column

If you have a thirst to hone your creative skills, *Design Matters* dives into the basics of proportions, forms, contrast and composition to give you the skill to tackle furniture design challenges with confidence.



Restrained beauty. This table shows a playful yet restrained use of ornament to highlight the legs and top.

BY PETER FOLLANSBEE

Three-legged Turned Chair

Panel seat requires beefy tenons for support.

Seventeenth-century chairs come in many styles: plain turned chairs with woven seats, carved joined chairs of oak or walnut, upholstered chairs in leather or wool, and one particular type of chair that is a little unusual these days – the turned chair with a board (really a panel) for a seat.

These chairs come in both four-legged and three-legged versions, from fairly austere to extremely complex and decorative. They can be made of ash, beech, fruitwoods and yew. Typically they are made with large-scale components, resulting in a massive appearance. The four-legged variety was made in New England during the 17th century, and, although there are many examples of three-legged ones surviving in England, there is no evidence of one being made in New England. I usually use ash for the turned parts, and any hardwood board for the seat panel. Oak is my first choice; I've also used elm or cherry.

I often make the three-legged version; it is challenging and fun to make, and it always gets a lot of attention. The geometry involved is a little more severe than with four-legged chairs, but not all that different. The distinctive element in these chairs is the joinery at the seat-rail height.

The joinery in three-legged chairs with board seats differs from four-legged chairs with woven seats. On a fiber-seat chair, the seat rails are at staggered heights; thus the tenons do not interfere inside the posts.

Seventeenth-century seating. *This period example of a three-legged turned chair is either Dutch or English, and is now on display at Plimoth Plantation, in Plymouth, Mass.*



The woven seat easily masks this height differential.

Hefty Seat Support

A paneled seat requires a different approach. Because the panel fits in a groove in the inner edges of the seat rails, the tenons are made to intersect inside the posts. First of all, this means the posts need to be beefier than they are in a fiber-seated chair. Second, the seat rails are also beefed-up, both because of the intersecting tenons and the groove.

In many examples, the seat rails have different tenons on each end – one end is rectangular and the other is a turned tenon. I turn the seat rails to about 1³/₄" in diameter, and turn down one end to a slightly oversized ³/₄" tenon. I make this tenon ¹/₂" longer than the post is thick. For my chairs, that usually means a tenon of slightly more than 3" in length that will go all the way through a 2³/₄" post. At the

opposite shoulder, I just turn a scribe line to delineate where the rectangular tenon's shoulders will be cut.

Once the rails are off the lathe, I lay out a rectangular tenon by scribing a centerline on the end grain of the turned piece and scribing the width from that. Cutting the tenon is pretty simple; I saw the shoulders and split the cheeks. Paring with a broad chisel brings the tenon down to its final thickness.

I cut the grooves with a plow plane. Once I have the rails made (the front rail is longer than the side rails), it's time to lay out and cut the joinery in the posts. I use through-mortises for both the rectangular and turned components; this seems to be the most common approach for the three-legged chairs. Some period pieces have blind bored mortises intersecting through rectangular mortises.

Centerlines are used again to lay out the rectangular through-mortise. I chop



Tenons squared. Here, you can see the square tenon as it comes through the leg as well as the unseated round tenon on the adjacent seat rail. Each rail has one square and one round tenon.

a little more than halfway in from one side, then turn the post 180° on the bench and chop from the other side. Any deviation is compensated for within the post. Chop one through-mortise on each of the three posts.

Dedicated Tenons

Now the pieces begin to become dedicated. I test-fit the rectangular tenon on the front seat rail to a front post, then do the same with the two remaining seat rails and posts. I drive the tenon all the way home and trim the protruding end a bit, leaving it a tad long. I scribe the plan of the seat either on the benchtop or on a board

or other surface large enough to get it full-scale. From this full-scale drawing I set an adjustable bevel to the angle between the front seat rail and the side seat rail that locks its tenon in. Then I fix the post to the workbench and tilt the seat rail over until the bevel reads plumb for the positioning of the brace and bit. Now bore through the post and the rectangular tenon.

These steps get repeated for the other two posts and seat rails. There is a lot of test-assembly involved. The real assembly is even hairier.

A Complicated Test

It starts with the three posts, each with its seat rail fully engaged in its rectangular mortise. The stretchers have shorter tenons (about 1-1/4") that fit in blind mortises bored in the posts. Next up is to begin setting the seat rails' turned tenons in their dedicated mortises. I just start these, then have to remember to slip the beveled seat panel in place, then begin driving the turned tenons home. You can't drive one turned tenon all the way through its rectangular tenon; you have to work them each in turn, driving the whole triangle bit by bit. While driving these, hold the seat board in place and watch for the stretchers, which come in a few beats after the seat rails. To complicate matters further, the stretchers happen at three different

heights; these are staggered so the tenons do not interfere with one another. So during assembly of the chair's frame, there are six things happening pretty much at the same time blow by blow – plus you have to have the beveled seat panel hovering in the air until the chair frame is driven home around it. I did one once, got the joints pounded home pretty much all the way, when my co-worker at the time nudged me and said, "You forgot the seat!" There was no glue in these joints, so I knocked them back open enough to get the seat panel in place then started driving it all back again.

I tend to use the format with one rectangular and one turned tenon on each seat rail, but there are many variations. Often the turned tenons are not through-tenons, but I find it easier if they are. I saw one chair in England that had a front rail with rectangular tenons on both ends, one side rail had two turned tenons, and the other side rail had one of each. Sometimes you see a large turned tenon penetrated by a smaller turned tenon. One advantage of the rectangular tenon is that it prevents the seat rail from spinning if it comes loose somehow.

And that's just to get the frame of the chair. The braces, crest rail and arms are no walk in the park either. There are lots of acute angles and tricky fitting to finish this thing off. But it's the seat rail joinery and fitting that really provide the most fun – if you want to call it that. **PWM**

Peter is the joiner at Plimoth Plantation in Plymouth, Mass., a non-profit museum at which visitors can learn about the experiences of the Wampanoag people and the Colonial English community of the 1600s.



Test-fit. Each rectangular tenon is fully seated in its mortise. Here, I'm holding the seat in place in its grooves as I pound home the round tenons for a dry-fit.



Staggering. While the seat rails are all on the same plane, the stretchers are not. So fitting both the top and bottom of the chair simultaneously can be a challenge (and don't forget to hold the seat panel in place, too).

Go Online FOR MORE ...

You'll find links to all these online extras at:

► popularwoodworking.com/oct10

WEB SITE: See more of Peter's work and read his blog.

WEB SITE: Discover more about Plimoth Plantation.

BLOG: Read Adam Cherubini's Arts & Mysteries blog.

IN OUR STORE: We featured a three-legged Chinese stool in the Winter 2009 issue of Woodworking Magazine.

All of our products are available online at:

► WoodworkersBookShop.com

BY DREW DEPENNING

Factory Cart Coffee Table

This reproduction of an industrial workhorse will give you years of use in your living room.

At the turn-of-the-century, no factory existed without several industrial carts (also known as trucks) at its disposal. From hauling lumber to carrying crankshafts to serving city ice, these workhorses served many functions.

Today, many of these antique carts have been restored for another purpose – furniture.

But if you don't have several hundred dollars (or more) to spend on a restored antique cart, you can build one that will serve for years in your living room.

Reclaimed Timber

To give my table the look of 100 years of use, I built the top with the most distressed wood I could find – boards from shipping pallets that were in our storeroom.

Let me warn you: Bringing these boards back from the brink of the dumpster is more time-consuming than you might think. For that reason, the measurements found in this article are based on a “clean” top built with 1x6 dimensional lumber.

The goal is to have a top 27" deep and 44" wide. Two 1x6 x 10' boards of No. 2 pine will be enough lumber for the top (and it's easy to find at the home center).

But if you prefer a more rustic look, ask at your local grocery store if you can grab a few pallets (or check outside by your office



Century-old chic. Inspired by re-purposed factory carts, this coffee table is a modern design solution for supporting your favorite books – and the occasional pair of feet.

loading dock) and pry off more boards than you think you'll need.

Sand down a spot on each board to help you select wood of consistent color. Don't forget to wear a dust mask – your lungs and sinuses will thank you.

Now, using your jigsaw (the cut will result in pleasing irregularity), trim or cut the top boards to 27" in length. (If you want a perfect 27" and square cut on all the boards, set up a stop on your miter saw).

Build the Box

The base frame of the table is built from 2x6 dimensional lumber. Two 2x6 x 8' boards should suffice for this project.

Because I want the tabletop to overhang the base by 1" on all sides, I'll cut the length of the side pieces to 42".

If you're using random-width pallet wood for the top, arrange the boards how you like, then adjust the length of your side pieces as necessary to accommodate a longer or shorter overall cart length.

After your sides are measured and cut with your miter saw, cut two 22"-long end pieces from your second 2x6.

To determine the length of the center brace, arrange the sides and ends in a rectangle on the floor, then measure up the middle. That's the length to cut for the center brace.

After setting your pocket screw jig to work with 1½" stock, drill three pocket

holes at each end of both end pieces on the inside faces of these boards. Do the same for the center brace.

On your bench, slide the side piece against a square block of scrap and use this setup to hold your end pieces at 90° while you drive home the 2½" pocket screws.

Once the outside frame is completed, cut two pieces of scrap to 10¼". Use these scraps to act as a shelf while you screw the center brace in place.

Distressed to Impress

If you're using pallet wood for the top, here's where you'll spend the extra time: bringing these boards back to life.

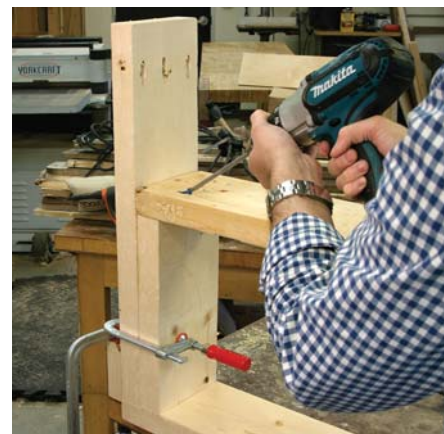

Scraps for a shelf. Use two 10¼" scraps to keep your brace centered and level.

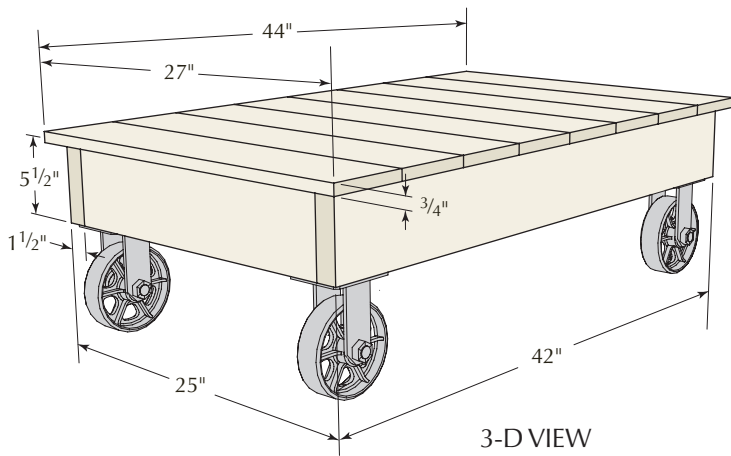

Factory Cart Coffee Table

NO.	ITEM	DIMENSIONS (INCHES)			MATERIAL
		T	W	L	
2	Sides	1 1/2	5 1/2	42	SPF*
2	Ends	1 1/2	5 1/2	22	SPF
1	Center brace	1 1/2	5 1/2	39	SPF
8	Top boards	3/4	5 1/2	27	No. 2 Pine
8	Corner braces	1 1/2	5 1/2	4	No. 2 Pine

* Spruce, pine or fir

HARDWARE

4	Casters, 6" wheel diameter
16	Lag screws, 1/4" x 1"
16	Washers, 1/4"
18	Coarse pocket screws, 2 1/2"

Using #100-grit abrasive in your random-orbit sander, begin to remove the layer of grime. To expedite the process, you might want to use something more aggressive, such as a belt sander.

Again, don't forget your dust mask. If you don't use one, don't be surprised when your facial tissues look like cleanup rags from an oil spill.

Clean up the boards, but be sure to leave some of the nicks and saw marks – this is the character you want to keep.

If you're using new dimensional lumber, smacking it with a set of old keys is a great way to apply dings to the top to give it distressed character.

Take your top boards to some rough concrete (a sidewalk works great) and bang up the corners and sides. This will make the top look as if it's seen plenty of industrial action.

Finally, use a #120-grit disc on your random-orbit sander to knock down all the corners and smooth down the dents.

Finish with Charm

Original carts often had the name of a company or city printed on the side. You can add that touch by using stencils and black spray paint. Use plenty of blue tape to avoid over-spray.

Use a hair dryer to set the paint, then rough up the label with your sander.

Finish the frame and top boards with a few coats of amber shellac before nailing the top boards in place.

With the frame on the floor, place one top board at the end of the frame. Use a combination square to square up the 1" overhang then nail the board in place.

Here, you can use finish nails or even regular framing nails for an industrial look. (If you use cut nails, don't forget to first drill pilot holes.)

With this piece as your reference, square and nail the remaining boards.

Before you attach the casters, nail two blocks of 2x6 scraps at each of the inside corners of the frame. This will give the casters support on all four corners.

I purchased the steel casters for my project online from one of many industrial supply companies. At your home center, you'll probably find 6" casters with rubber wheels. They may not look old-fashioned, but they won't mark your floors, either.



Dust protection. The dust from pallet lumber is nasty stuff. Wear a dust mask to spare your sinuses and lungs.

To attach the casters, first drill pilot holes, then slip washers on your lag screws and use a wrench to drive the screws.

Finally, prop up your feet and enjoy your piece of custom furniture. And don't forget to use a coaster! **PWM**

Drew is the associate editor for the web for this magazine. Contact him at drew.depensing@fwmedia.com.

Go Online FOR MORE ...

You'll find links to all these online extras at:

► popularwoodworking.com/oct10

BLOG: Read more about the inspiration for this project and find additional tips on our Editors' Blog.

PLAN: Download the free SketchUp model for the Factory Cart Coffee Table.

ARTICLES: All the "I Can Do That" articles are free online.

Download the complete "I Can Do That" manual for free:

► popularwoodworking.com/icandothat

All of our products are available online at:

► WoodworkersBookShop.com

About This Column

Our "I Can Do That" column features projects that can be completed by any woodworker with a modest (but decent) kit of tools in less than two days of shop time, and using raw materials that are available at any home center. We offer a free online manual in PDF format that explains all the tools and



shows you how to perform the basic operations in a step-by-step format. Visit ICanDoThatExtras.com to download the free manual.

Arts & Crafts Buffet

BY ROBERT W. LANG

Recipe for successful design: Steal your ideas from the best.

I designed this buffet cabinet a couple years ago for a weekend seminar on Arts & Crafts joinery. After the class I added a 3-D model to the *Popular Woodworking Magazine* online SketchUp collection. It was an easy way to provide detailed plans for those in attendance. As time passed, the model rose to the top of the collection, based on popularity.

My goal in designing it was to combine several classic elements from the early 20th century, without building a reproduction of any one piece in particular. I was looking to design a piece with a contemporary feel, but that was grounded in traditional Arts & Crafts period elements. Apparently I swiped the right details from the right sources to make a successful piece.

The wide overhanging top with bread-board ends, the finger-jointed drawer and the sculpted handles were all borrowed from the designs of Charles and Henry Greene. The proportions of the door stiles and rails were lifted right from the Gustav Stickley stylebook, and the double-tapered legs are a Harvey Ellis element turned upside down.

Equally important are the overall proportions and the rounded edges that ease the transitions where there is a change of direction or a change in plane. The light color of the soft maple keeps the cabinet from looking too formal or too masculine. Absent are the elements often seen in new pieces based on old designs. Corbels and spindles were banished to the land of overused and misapplied design features.



Classic combination. This buffet has a contemporary feel, but it is a combination of classic design elements of the American Arts & Crafts period of the early 20th century.

Skinny Legs & All

The legs are important visually; the upward taper leads the eye to the top, and the wide portion near the bottom makes the base appear substantial. Combined with the wide rails on the bottom of the doors, the case sits on a firm visual foundation, and it looks larger and heavier than it really is.

The legs are also key elements in the structure. Each leg is a corner for two different frames. There is a lot of joinery in each, and to help keep track of the leg locations, I laid out the tapers after resawing the legs from 8/4 stock. My local supplier didn't have material available simply to mill the legs to the 1¹/₄" finished dimension, so I bought thicker than I needed, resawed

the boards to 1³/₈" and saved the thin off-cuts for the bottom of the drawer.

My method is to work out all the joinery first, then cut pieces to shape and round the edges just before final assembly. I cut the ³/₈"-wide stopped grooves for the side and back panels first, using a plunge router. I then lowered the depth setting and cut the mortises in the wide faces of the legs with the same router.

There isn't enough of a flat area on the narrow sides of the legs to support the router, so I moved to the hollow-chisel mortiser to add the mortises for the front and back rails. Then I cut the tenons on the ends of the top and bottom side rails. I used a backsaw for the shoulder cuts, then cut the cheeks on the band saw.

I dry-fit the side rails to the legs, forming side sub-assemblies without panels. Then I made the joints for the front and back rails. In the back, the mortises fall within the grooves for the back panel. In the front of the case, the mortises are the only joinery.

To keep the backs of the front and back rails flush with the back of the legs, I set my marking gauge directly to the edge of a mortise. Then I used that setting to mark out the tenons. I cut the tenon shoulders with my backsaw and the cheeks on the band saw. After fitting these joints, I did another dry run, connecting the two side assemblies with the front and back rails.

Come Together

With a complex piece such as this, the best way to ensure that everything fits together is to make careful dry runs, then pull the actual dimensions for the next piece to be fabricated from the subassembly. With the legs connected side to side and front to back, I made sure the carcass was square before making the bottom.

The bottom fits between the front and back rails, and at the ends there is a pair of through-tenons. The critical distance is from shoulder to shoulder on these tenons. After ripping the bottom to width, I held the bottom in place below the rails on the carcass and marked the shoulder locations directly.

Then it all came back apart to cut the through-mortises in the bottom side rails. These pieces are too short to clamp to the bench and have room for the plunge router, and too wide to fit easily in the mortiser.



Better than numbers. Setting the marking gauge directly to the edge of the mortise ensures exact alignment of the rail and leg.



Knowledge is power. Measuring with calipers reveals the exact thickness of the tenon and how far to set the depth of the router bit.



When to stop. When a corner can be forced into the mortise, the thickness is close. Then it's time to cut the edges of the tenons.



Where it belongs. Marking the tenons directly from the mortises is faster and far more accurate than measuring.

I drilled out the bulk of the waste with a Forstner bit at the drill press, then cleaned up the mortises with chisels and a float.

The first step in making the tenons was to cut a wide rabbet on both the top and bottom of the shelf. I clamped a straightedge on the shoulder line and used a router with a straight bit and a top-mounted flush guide bearing.

I made a cut on both ends on the top side, then I clamped the straightedge on the bottom. I carefully made a cut, then measured the thickness of the tenon, comparing it to the height of the mortise. When I could force a corner of the bottom into the mortise, I knew I was as close as I wanted to come with the router.

I held the backside of the rail against the end of the cabinet bottom and marked the ends of the tenons from the mortises. I cut the ends of the tenons with my backsaw, then turned the bottom 90° and used the same tool to make the two end cuts. I used a jigsaw to remove the material between the tenons and stayed about ¹/₈" away from the shoulder's edge.



Easier by hand. These cuts could be made at the table saw, but that would be an awkward operation. Cutting the tenons by hand allows me to see what is going on.

There is just enough material from the first router cut that defines the shoulder to guide the bearing of a flush-trim router bit. That took care of making a straight edge between the tenons, except for a small quarter circle in the corners. A little chisel work removed that extra material, and I was ready to test the fit.

With a chisel, I cut a small chamfer around the back edges of the mortises, and I used my block plane to chamfer the ends of the tenons. A few taps with a mallet revealed the tight spots on the tenons. Some work with a shoulder plane and float brought the tenons down to size, and after achieving a good fit with both rails on the ends of the bottom, I was ready to dry-fit the rest of the case.

Shapes of Things

After another test-fit and a bit of tweaking, I was ready for a break from joinery, so I cut the tapers on the legs at the band saw. I cleaned up the saw marks with a light pass across the jointer, then began smoothing surfaces and rounding edges. I began smoothing all the flat surfaces with a plane to remove mill marks and evidence of beatings from my test assemblies.

I took my cue for the edge treatment from Greene & Greene. Instead of running a roundover bit in a router around the edges, I used my block plane to hand-form a radius on all the exposed edges. This doesn't take as long as you might think, and this method allows for variation of the edge radius.

The radius on the legs is larger at the bottom than at the top. This follows the taper of the legs and adds a subtlety to the edges that a router couldn't provide. My method for doing this efficiently is to



Dry-fit now, panels later. The only way to know if things will really fit is to put the carcass together. The panels will be added the next time around.

open wide the mouth of my block plane and skew the blade as far as I can.

With the blade cocked, the plane takes a big bite on one side and a fine cut on the other. By shifting the position of the plane as I tilt it on the edge of the board, I can remove a large chamfered edge to begin

the cut, then make fine finishing cuts to remove the arrises and form a nice curve. Shifting the position of the plane laterally allows it to do coarse, medium and fine work without fiddling with the tool.

I also cut the arches at the bottom edge of the front and side rails at the band saw,



Why this slides. Opening the mouth of the block plane provides room to skew the iron.



Big mouth, quick work. This side of the plane will take a coarse cut, removing a lot of material in a hurry.



Fine on this side. The other side of the plane takes a small finishing cut. The amount of material removed and the quality of cut is controlled by moving the plane laterally.



No-spread zone. A single through-dovetail on each of the top rails locks the sides of the case together and adds an attractive detail.

wide rabbet on the bottom of the ends, then cut a dovetail on both ends of each rail. With the rails in position, I marked the top side rails to cut the sockets.

I used a wheel marking gauge to mark the bottom of the dovetail sockets in the rails and a knife to mark the vertical cuts. After sawing the outside edges with my dovetail saw, I used a chisel to remove the waste (vertical saw cuts into the waste may make waste removal easier). On a small joint such as this, the marking gauge can be used as a small router, providing a flat bottom for the socket.

Tighten Up

Fighting off the urge to glue the entire box together, I went over all the parts with a card scraper then fine sandpaper. Then I put the side panels in place and glued the rails between the legs, then let these subassemblies dry overnight. This sim-

plified the final assembly by reducing the number of parts.

The obvious tricky part of putting things together for real is down low. The through-tenons for the cabinet bottoms need to slide through the mortises in the rail at the same time the tenons in the front and back rails go into the legs. I put the entire cabinet together without any glue to practice my technique and to avoid any trauma during the real thing.

The other tricky part is that, with the legs tapered, there isn't a good surface to place any clamps. Fortunately one of my bad habits was ready to provide a solution. I rarely throw anything away, so I found the tapered offcuts from the legs over by the band saw. Good old blue painter's tape held these to the legs, providing a flat place to put the clamps.

I put one of the side assemblies on my bench with the inside of the case facing up, applied glue to the mortises and put the rails in place. I started the tenons on the end of the bottom into the side rail mortises, then brushed glue on the inner portion of the tenons. This kept the glue off the exposed ends of the tenons. That was the easy end.

I slid the shiplapped back panels into position, then brushed glue on the tenons in the rails before I started the through-tenons into the mortises in the lower side rail. At the same time, I lined up the other tenons with their matching mortises. I tapped down on the rail until all but about $\frac{1}{2}$ " of the through-tenon was visible between the tenon shoulder and the rail.

I reached in to brush more glue on the tenons, then tapped on the outside of the side subassembly to close the joints. I tried to tap directly over each tenon on the legs as the second side of the cabinet moved into place. When the side was about $\frac{1}{8}$ " away from closing, I put down the mallet and picked up my cabinet clamps.

I tightened the clamps and went on a hunt for glue squeeze-out near the joints. I try to control squeeze-out by applying just enough glue to the joint. The goal is to apply the glue so that it almost squeezes out. The last step in the carcass assembly was to jockey the web frame into position and glue the long edge to the rail below the drawer opening. At the back, a couple pocket screws from below attach the back of the frame to the back legs.



E pluribus unum. Subassemblies minimize the number of pieces to contend with during the final assembly. After clamping, check to see that they are square.



Where bottom and side collide. This isn't as hard as it looks; the side will be one piece, and trial runs ensure that everything fits.



Tape for the tapers. Offcuts from tapering the legs are taped in place to provide a flat surface for the clamps.



Sliding home. Start all the mortises and get the parts close with a rubber mallet. A few clamps close the joints side to side.



Simple fix. A pocket screw at each end attaches the drawer frame to the inside of the back legs.

I had a little glue bead appear here and there, and those were scraped off with the back of a sharp, wide chisel before the glue had time to dry. I keep a wet rag handy to keep the chisel clean and don't wipe the wood unless I have to.

Feeling Groovy

The doors are standard frame-and-panel construction; 1/4"-wide grooves run along the inside edges, and haunched tenons in the rails fit mortises in the stiles. The elements of the doors are all wider than they need to be. This enhances the overall appearance of the doors in the opening; there is a better balance in the middle, and the wide lower rails reinforce the sense of visual weight toward the bottom of the cabinet.

The combined width of the doors is 1" less than the width of the opening; thin strips are glued inside the legs to carry the hinges. This detail allows the doors to be set back from the front edges of the rails while still able to swing freely past the inside edges of the legs. These features are common in Gustav Stickley designs. The variation of planes adds visual interest to the unadorned surfaces.



L of a solution. A simple jig attached to the table saw's miter gauge supports the work and indicates the exact line of the cut.

The drawer is joined at the front with Greene & Greene-style finger joints. The fingers are graduated in width, and they extend about 1/8" past the drawer front. I made a simple L-shaped fixture and attached it to the table saw's miter gauge to assist in cutting the joints. After attaching the fixture, I ran it through the saw blade to cut a slot in the lower portion.

I laid out the fingers on one of the drawer sides, making sure to clearly mark the waste area. Then I adjusted the height



Balancing act. After cutting the first set of fingers, place the end of a side on the drawer front to mark the matching parts of the joint.

of the blade to match the marked depth of the cut between the fingers. I placed the two drawer sides together and aligned the pencil marks on the wood with the saw cut in the fixture.

When the sides were in position, I clamped the stacked sides to the back of the fixture. I cut the ends of each finger before removing the waste material in between. When the sides were finished, I placed them on each end of the drawer front to transfer the cutlines.

After marking the waste area in the drawer front joints, I lowered the height



Hold the line. Place the pencil line next to the kerf in the guide to cut just inside the line.



Easy now. The two parts should slide together easily – but without any slop. If it's too tight, file the fat fingers.

of the saw blade to leave the ends of the drawer front barely proud of the drawer sides. I then cut the fingers in the drawer front in the same way that I cut the mating ends of the drawer sides.

When I was happy with the joints at the front of the drawer, I cut grooves with a small plunge router in the sides and front for the drawer bottom. The grooves in the sides stop at the front to match the depth of the groove in the drawer front. The groove falls within the first finger, so it can run from end to end through the drawer front.

The back of the drawer is narrower than the sides. It comes down from the top of the drawer and ends at the top of the groove, allowing the drawer bottom to be slid into place after the drawer is assembled. The drawer bottom is one solid panel, glued up from the leg leftovers and planed to $\frac{1}{4}$ " thickness. The back and sides of the drawer are joined with through-dovetails.

Roundabout

Like the cabinet it lives in, the drawer was put together and taken back apart several times. With the sides in place, I marked the front edge of the drawer front on the fingers of the drawer sides. This provided a target for rounding the edges of the fingers. I clamped the sides in my vise and went to work with a small rasp.

As with the other radiused edges, I began by cutting a 45° chamfer, working in the direction of the grain. When the edge of the chamfer reached about two-thirds of the distance from the end to the pencil line, I removed the sharp edges and

began to transform the faceted edges to a gentle curve. When I got close to the lines, I switched to a piece of #180-grit Abranet to remove the rasp marks.

I didn't want any glue to squeeze out when I assembled the drawer, so I carefully applied glue to the recesses between the fingers with an acid brush. I began with the end-grain surfaces, let the glue soak in for a few minutes, then applied glue to all the mating surfaces. I clamped the drawer box together at the front, placing small blocks of scrap between the fingers to provide a bearing surface for the clamps.

I planed the bottom edge of the drawer front before assembly to keep the edge of the front $\frac{1}{16}$ " above the bottom edge of the sides. When I fit the drawer in the opening, I was able to plane the sides to get a good fit and keep a slight gap between the drawer front and the case rails. Drawer guides are glued on to the web frame to keep the drawer sliding straight. A rabbit

on the bottom edge of the guide allowed me to reach in with a block plane to tweak the fit.

Speaking in Tongues

The breadboard ends have a $\frac{1}{4}$ "-wide, $\frac{1}{2}$ "-deep groove along each inside edge. I made each groove with a straight bit in a small plunge router, stopping the groove about 1" in from the ends. I located the matching tongue on the top by clamping a plywood straightedge to the line, and made the cut with a flush-trim bit in the router.

The tongue is $1\frac{1}{4}$ " long; the extra $\frac{3}{4}$ " was used to make three tenons to hold the breadboard in place. The tenons are about 2" wide; the outer tenons end about $\frac{1}{8}$ " in from the end of the groove. After cutting the tenons, I marked their locations on the breadboard and cut the mortises with the hollow chisel mortiser.

The middle mortise fits the tenon tightly in width, but the end two were cut wider to give the top some room to move. These joints are pinned with square walnut plugs that go completely through the breadboard and the tenons. The square holes for the $\frac{1}{4}$ " and $\frac{5}{16}$ " plugs we made with punches developed by Darrell Peart. These punches work in conjunction with a drill bit, so it was simple to start from the show side, punch the square and drill the holes through the assembled joint.

After drilling, I took the joint apart and placed the drill bit in each hole, then used the punch to square the sides. I elongated the holes in the two outer tenons so they could move in the mortises as the seasons change. On final assembly of the top, I applied glue to the center tenon only. The outer joints are held in place with pegs.



Cutting corners. Mark where the end of the drawer side intersects the fingers on the drawer front. Round over the edges to the pencil line.

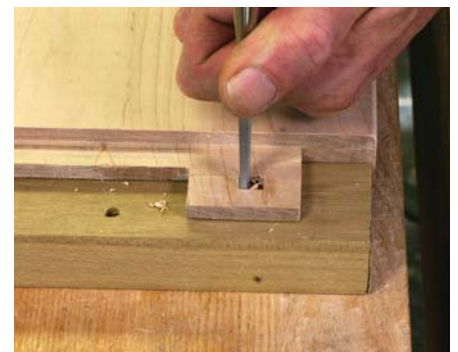

Room to move. Elongate the sides of the holes that pass through the tenons. This will allow the top to expand and contract against the breadboard ends.



Adjustable guide. The drawer guides are glued to the web frame. The short length and rabbeted bottom edge provide room to adjust the width with a block plane.

Maxwell's Silver Hammer

I also added decorative pegs ($\frac{3}{16}$ ", $\frac{1}{4}$ " and $\frac{5}{16}$ "") to the joint locations on the front legs, the door stiles and the drawer front. Recesses of about $\frac{1}{4}$ " deep for the plugs were made with the square punches. The plugs were ripped from some quartersawn walnut. I cut square strips on the table saw, about $\frac{1}{32}$ " larger than the recesses.

I smoothed the long edges of these strips with my block plane, and I measured the width and thickness with calipers until they were close in size, but still a bit larger than the holes. I dropped the end extension of the calipers into the holes to find the correct length for the pegs, then used the jaws of the calipers to transfer this measurement to the strips.

I rounded one end of each strip with a coarse file, followed by sandpaper, before cutting the pegs to length. After cutting, I used a chisel to chamfer the back edges

of the pegs to make it easier to start them in the holes. After the pegs were sanded, I treated them with a solution of vinegar in which I'd soaked iron, then cut them to length. This solution reacts with the tannic acid in the walnut and turns the wood black. (Brian Boggs explains an alternative ebonizing process in the June 2009 issue of *Popular Woodworking* (#176).)

I used an artist's brush to coat the inside of each hole with glue, inserted a peg and tapped it in place with a brass hammer. The smooth hard surface of the hammer burnished the faces of the pegs.

Because the doors hang on strips glued to the inside of the door opening, mortising the hinges was simple. I trimmed the doors to $\frac{3}{32}$ " less than the height of the opening and cut the strips to an exact fit. I put a door (hinge stile up) in my vise and placed a strip along the edge, using a dime to space the top of the strip with the top of the door.

Then I marked the locations of the hinges. I cut the hinge mortises in the doors with a small plunge router equipped with a fence. I put a block of wood behind the door and adjusted the position of the door in the vise so that the edge of the door was flush with the top of the block. This kept the base of the router flat on the thin edge without any danger of tipping.

The mortises in the hinge strips were cut with the strips clamped flat to the benchtop. After routing, I squared the corners of the mortises then screwed the hinges in position on the doors and on the strips. Then I removed the hinges, and

Supplies

Lee Valley

leevalley.com or 800-871-8158

1 set ▶ square hole punches
#50K59.20, \$24.50-\$26.50 each,
\$129 for set of six

2 ▶ ball catches
#00W12.00, \$1.50 each

Prices correct at time of publication.

glued the strips to the inside of the legs, with the back of the strips flush with the back of the legs.

I glued a small block of wood behind the rail of the face frame above the doors to provide a place to mount brass ball catches to keep the doors shut. The handles were shaped at the band saw, then the edges were rounded with a block plane and rasps. I made relief cuts on the back of the handles with a carving gouge to provide a finger grip. Those cuts were refined with a gooseneck scraper.

The first coat of finish is clear shellac. I used the canned stuff from the hardware store and thinned it about 30 percent. This left the color a bit cold to my eye, so I added about 25 percent amber shellac to the mix for the second, third and fourth coats. After letting the shellac dry, I buffed the surface with a nylon abrasive pad, then applied a coat of paste wax. **PWM**

Bob is executive editor of *Popular Woodworking Magazine*. He can be reached at robert.lang@fwmedia.com.



One-two punch. Locate the punch and smack it a couple times with a hammer. This cuts sharp corners and straight sides for the plug hole.



Waste removal: Follow with a drill through the hole in the punch body. This removes the waste within the square recess.

Go Online FOR MORE ...

You'll find links to all these online extras at:

▶ popularwoodworking.com/aug10

VIDEO: Watch Bob's table saw techniques for cutting the drawer finger joints.

PLAN: Download a free 3-D model of this project in SketchUp format.

WEB SITE: Bob has written several books about Arts & Crafts furniture; they're all available from his web site.

BLOG: Read "Peart's Punches for Perfect Square Holes."

IN OUR STORE: "Greene & Greene Furniture: Poems of Wood of Light."

All of our products are available online at:

▶ WoodworkersBookShop.com

Understand & Use a Bowsaw

BY MICHAEL DUNBAR

These traditional tools are woefully misunderstood by modern craftsmen. Here's a primer.

In the 1970s when I was the young, innocent and naive chairmaker at Strawberry Banke, a museum in Portsmouth, N.H., 50,000 tourists passed through my shop each summer. It never failed that when I was cutting out a chair seat with a bowsaw some wag would quip loudly, "You need a band saw!"

While these comics guffawed at their own cleverness I was puzzled by the comment's inanity. I knew I was doing just fine and didn't need a band saw. I did my work quickly and efficiently with two different sized bowsaws – large and small. The saws did all the work I required. I cut out two chair seats a week and four scrolled hands. If the chair had a crest, I cut that too.

The saws had cost very little, relative to a band saw. When I was done, I hung them on the wall, where they took up no floor space in my cramped shop. I was perfectly happy working this way.

After I had grown up and started demonstrating at woodworking shows, I continued to get the same comment from woodworkers who, carried away with their own wittiness, could not stop themselves from blurting, "You need a band saw!" It was then that I realized everyone thought I should have a band saw because they didn't know about bowsaws. It was their loss. They missed out on the enjoyment of using a very efficient tool that has been around since the Bronze Age and was used in Europe and America to produce the



Bowsaws for the bench. Many modern woodworkers avoid bowsaws because they don't understand when or how to use them in the shop.

great 18th-century furniture masterpieces we go to museums to admire.

Meet the Bowsaw, Moderner

In the history of woodworking there were many types of bowsaws, some developed by tradesmen to meet their own particular needs. For example, inlay makers cut out very small pieces with a fret saw, while

wheelwrights cut out sections for wooden wheels (fellows) with a fellow saw. Today, we use far fewer bowsaws, but these share in common a number of features with all their ancestors. First is a thin blade that conserved on steel and allowed the bowsaw to change directions more easily than would be permitted by a flat-bladed handsaw. Second is a wooden frame that

secures the blade. Third are the handles, which provide the user with something to hold, and which can be turned to adjust the direction of cut. Finally, every bowsaw has some method that tensions the blade – that is, stretches it tight.

For general woodworking – the sort of things most of us do – you need only two bowsaws. A large saw with about a 25"-long blade is great for ripping or cutting shapes out of heavy stock. A smaller saw with about a 12" blade is better for cutting out smaller parts.

The biggest obstacle you face in adding bowsaws to your repertoire of woodworking skills is obtaining a saw. A lot of woodworking catalogs and web sites sell bowsaws, but beware: Most of these saws are cheaply made, lightweight and inadequate for woodworking. The same rule that applies to the lathe and workbench applies to the bowsaw. Flimsy equals worthless.

Why? Sawing requires force. The reason my large bowsaw is so efficient is that I can put a lot of weight and muscle behind it without the saw flexing or the frame wiggling. If either of these happens, the cutting action is less effective and the saw is harder to direct. My prejudice against commercial bowsaws is well founded. I have had one fall apart in my hands while cutting a chair seat.

Here's a Good Bowsaw

These are the criteria to look for in a saw. You want a rigid hardwood frame, which will give the saw serious heft. The strut should attach to the ends with mortise-and-tenon joints. These should be deep and well fit, with no play or slop. You want the handle rods to be metal (usually brass). The rods should have a tight friction fit where they pass through the frame and secure the blade, so the blade cannot turn while in use. In other words, adjusting the saw should require effort. The blade should be secured to the rods by a slot pierced by a metal pin. All these parts should be robust enough not to wear or break. The strut and handles should be designed for comfort and have smooth relieved corners that will not raise blisters. I particularly like the octagonal handles on my saws.

You have to be able to tension or stretch the blade so it does not flex or twist. Most saws are tensioned by twisting a hank of string with a wooden toggle. I do not



How to avoid the crack. A toggle such as this allows you to adjust the frame's tension by half-turns, which is better for the saw.

like wire that is tightened with a nut. This mechanism is not as effective. For string, I recommend waxed cobbler's twine. It holds up well to years of use and does not stretch.

Most saws use a simple stick as a toggle for twisting and tightening the twine. Overlapping the toggle on the center strut keeps the twine from unwinding. However, the tighter you twist the twine, the tighter it becomes on the toggle. At some point the toggle will not slide at all and you can no longer tension the saw by full turns. This can be a problem, because over tightening can break the frame. The answer is the yoke with a sliding toggle as shown in the picture above.

The grooved yoke fits into the twisted rope, allowing the slotted toggle to slide freely. You can make full or half turns without any fuss.

And the Right Blades

The type of blade you choose to mount in your saw is determined by your intended use for the tool. I use my large bowsaw most frequently for cutting out chair seats. This means I am driving it through nearly 2" of pine. I want my blade to be aggressive and fast. I don't care if the cut leaves a coarse surface. When I am done, I will shape the edge of the seat and remove all evidence of the sawing. I use a length of 6 points per inch (ppi) $\frac{3}{8}$ " band saw blade in the saw.

Because I need the blade to be stiff and not flex, I use a .035"-thick blade rather than the more common .025". You may not be able to buy this blade in your local woodworking store, but you can find it on the Internet and order online. The blade on my small bowsaw is a 16 ppi, $\frac{1}{4}$ " saw blade.

If you make your own blades, you will have to drill holes for the pins that pass through the handle rods. The saw steel is too hard to drill, so soften the ends by heating them with a propane torch.

Because most commercial bowsaws are inadequate, you are faced with either making your own or buying one from a craftsman/maker. I obtained my saws from Woodjoy Tools (woodjoytools.com). This site also sells parts and materials for saws. Because a bowsaw requires only several small pieces of hardwood, it is a good project for using up some cutoffs or scrap.

Bench or Horizontal Sawing With the Large Saw

The large bowsaw cuts on the down, or push stroke, and the blade is mounted in this direction. The teeth are turned so they are at a right angle to the frame. A bowsaw is a turning saw, which means the blade can be turned so it is at a setting other than 90° to the frame, but I find I seldom do this. If you do need to turn the blade, loosen the toggle and turn the upper and lower handles at the same time. If you turn them separately, you risk twisting or breaking the blade.

The large saw cuts with the stock secured to the benchtop, so your bench needs to be the right height for sawing. Most modern benches are too high for most hand tools, and certainly for the large bowsaw. My test for proper bench height is to stand erect next to the bench with your arm straight and rigid at your side. Bend your hand at the wrist so it is parallel to the floor. The palm of your hand establishes the best height for your bench. If your bench is too high for the bowsaw,

"It is far better to work with one plane, one saw, one chisel and a few accessories, all of them good, honest steel, properly sharpened, than it is to have a cellar full of inadequate devices."

— "How to Work With Tools and Wood"
(1942) from Stanley Tools

either trim the legs or stand on a platform when sawing.

Secure the work to the bench with clamps that are heavy and strong enough to hold it fast. How you position the stock on the bench depends on the work. To be as efficient as possible, here are a couple things to consider before beginning. With the big saw you travel along with the tool. Make sure you can move your body freely.

You do not want to stop and reposition your stock any more than is necessary. If you are ripping, clamp the stock to the bench so the kerf is close to the edge. This reduces any chance of the stock flexing. Short pieces and round shapes such as chair seats are easiest to cut with the stock clamped to a corner, although you will have to reposition the seat blank at least once. If in cutting a shape you have to cut around corners with a radius longer than your saw's throat, trim the corners first.

A bowsaw has limitations. Like a band saw, its throat is only so wide. The maximum for my big saw is 6 1/2". This means the saw works best for ripping narrow lengths and is useless when it comes to cutting plywood panels.

With the work secured, you are ready to use the saw. Grip it in the manner I am about to describe. Hold the strut near the top with your dominant hand (I'm right-handed) and grip the upper handle with your other hand. Stand facing the direction of cut, so the saw is in front of you.

Any hand-driven saw works best with a smooth stroke that uses almost the entire length of the blade. The same applies to a bowsaw. Also, any saw works best and requires the least effort if you use it properly. With a large bowsaw, the best advantage comes from using your entire body rather than your arms. Sawing is an aerobic exercise, and if done correctly you will not become fatigued or winded.



It tracks tightly. While the surface from a bowsaw might be rough, I find a bowsaw is easier to keep from drifting off line than a band saw.

To prepare for the down stroke raise the saw until the lower end of the blade is engaged on the line. As the saw descends use the entire length of the blade almost to the upper end. On the down stroke, come up slightly on your toes. Your heels will come off the floor. Flex your knees and bend slightly at the waist. This action, rather than your arms, is what moves the saw. While you cannot avoid some movement of your shoulders, it is surprising how little your arms are involved. Mostly, your arms and shoulders hold the saw in the cutting position while your body moves it. Raise the blade not with your arms, but by straightening your body and rocking your feet back flat on the floor.

You can understand the efficiency in this motion. Rather than trying to drive the saw with your arms and shoulders, you are putting the weight of your torso behind the blade.

At the end of the down stroke, pull the saw blade back slightly in the kerf. This accomplishes several things. First, the end of the kerf is tighter, so withdrawing the blade slightly makes it easier to lift the saw. Withdrawing the blade also clears trapped sawdust out of the kerf, especially at the end where you are cutting.

Finally, withdrawing the blade makes sawing more accurate. Here's why. As you start the next down stroke you reposition the blade on the line. Repeat this with every stroke. While this continuous correction will create a more ragged edge than that left by a band saw, an experienced bowsawyer has less trouble with drifting off line. When you are done and examine the sawn edge, you can see where you started each stroke.

The key to using the bowsaw efficiently is to make the movement repetitive and



Get a grip. When ripping, grasp the strut with one hand and the handle with the other. Begin your kerf with the lower part of the blade engaged in the wood.



Use your whole body. When using the large saw like this, don't use only your arms. Use the mass of your body to help bring the saw down. Flex your knees and bend slightly at the waist.

fluid. Any halting or jerkiness indicates you are doing something wrong. Once you have achieved skill with the tool, you will be amazed at how efficient and fast a bowsaw is.

When ripping with the large bowsaw, hold the saw so the frame is tilted away from you. Because it's on a diagonal, more of the blade is in the kerf, and it is easier to stay on the line. The kerf's leading edge – below the surface – is angled and still aligned with the line you are following.

As you cut a curve, bring the frame into vertical, so it is cutting in the same manner as a band saw. If you tilt the frame as you do when ripping, the cut around the curve will be beveled, rather than at a right angle to the surface.



Rip away. When you are ripping with the large saw, tilt the frame away from you slightly to help stay on your line.

Vertical or Vise Sawing

The small saw is intended for detail work and for cutting out small parts. It simply does not have the heft to cut heavy stock. As with the big saw, I generally position the blade at a right angle to the frame. Like a coping saw this tool, too, cuts on the pull stroke rather than on the push.

The pull-stroke grip requires holding the saw by both handles. Because your arm



Straight through the curves. When you turn a corner, bring the frame up until it's vertical, which prevents the edge from becoming beveled.



Armed with a small saw. When using the small bowsaw, move your arms in a reciprocating fashion. Keep your torso steady.

reaches over the work, it cannot be secured horizontally on a benchtop. Instead, the work is held vertically in a vise. With the small saw you generally have to stop and adjust the work to give the saw access to more of the pattern, but this is a lot faster and easier than adjusting clamps.

Once again, the saw's action needs to be smooth and use as much of the blade length as practical. In use, the small saw's stroke is fast. Imagine yourself as a human scroll saw. Each pull stroke cuts and advances the kerf. On the back stroke, lift the blade slightly and reset it on the line before the next cut.

Operating the small saw is the opposite of the larger. While the big saw uses your entire body but not your arms, the small saw uses just your arms and shoulders but not your body. Plant your feet and bend your knees to bring your shoulders down to the height of the work. Retain this position. Lock your wrists and move the saw with your elbows and shoulders.

Storage is Simple

When you are finished with a bowsaw, release the tension on the blade. Turning the toggle backward one turn is sufficient. You don't want to loosen the frame so much that it falls apart. I store my saws by hanging them on the wall. However, bowsaws lie flat and can be stored in a tool box. If you do this, find a way to protect the blade from other tools, and to protect you from it. **PWM**

Michael Dunbar runs *The Windsor Institute* in Hampton, N.H. (thewindsorinstitute.com), the premier school for Windsor chairmaking.

Go Online FOR MORE ...

You'll find links to all these online extras at:

► popularwoodworking.com/oct10

VIDEO: See a video of Michael Dunbar using a large and a small bowsaw.

ARTICLE: Read Frank Klausz's article on the bowsaws in his shop.

WEB SITE: Visit the web site of *The Windsor Institute*.

TO BUY: Purchase bowsaws and accessories from WoodJoy Tools.

IN OUR STORE: "Handtool Essentials" teaches you critical hand skills.

All of our products are available online at:

► WoodworkersBookShop.com

Veneer is the Future: Part 1

BY MARC ADAMS

We make the case that the material used on the finest furniture of the past should be in your future.

I work with veneers! There I said it – this must be what it feels like to come out of the closet.

I cut my teeth as a woodworker when veneering furniture was frowned upon. And often I had to educate my clients on why veneered furniture is as worthy as solid-wood furniture.

Wood veneer is a remarkable material that has been used for centuries. It is cost-efficient, easy to work, comes in a variety of colors and textures, can be purchased in sequential order and matched together architecturally, can be used decoratively, is easy to repair and can even increase the value of your work. That's right – increase the value of your work.

The truth is that the majority of the priceless furniture pieces made during the Renaissance are covered with veneer. In fact, working with veneer goes back centuries before the Renaissance. Egyptians imported cedar, cypress and ebony from Syria and Africa. These logs were cut into veneers to adorn the furniture of the Pharaohs. So the question is, if veneer was so highly regarded throughout antiquity, then why would using it in modern America be so objectionable?

I guess it boils down to two reasons: resources and production. When the first settlers came to this land, trees were abundant and the furniture built by the Colonists was made with simple tools and



More dazzling than difficult. Veneer can allow you to do things you cannot accomplish with solid wood. And it is more straightforward than you think. This table was built by the author's daughter, Markee Adams.

local materials. Because wood was so readily available and easy to work, it became the standard for how furniture was to be made. Because traditional furniture was handmade with solid wood, it's perceived as more durable and, probably because it is heavier, far more substantial. For this reason, the mindset is that solid wood means better quality.

"Never be afraid to try something new. Remember: Noah had never built an ark, but it was a large group of professionals that built the Titanic."

— Mike Moncrief
Mayor of Ft. Worth, Texas
2010 commencement address at
Texas Christian University

Veneer's Black Eye

Although veneer slicing machines were first introduced in America in the early 1800s, early factory furniture during that century was sometimes crudely produced with disastrous results – adding to the eventual black eye of veneer. The straw that broke the camel's back happened after World War II, when servicemen were taking advantage of the GI Bill. The demand for schools, hospitals, new businesses and homes was driving a need to produce furniture and cabinets at a fevered pitch. The real problem was the failure of the core material that the veneer was glued to. Early particleboard was not the same product that it is today, and MDF didn't exist. Early particleboard was brittle, reacted horribly to water, had no structural ability and physically stank.

Nearly all the furniture produced from 1945 to the early '70s was veneered on

this inferior product, and, when the particleboard core failed, the veneer on the surface took the rap. Strike two!

Fortunately, veneer is persistent and has rebounded well during the last 20 years. Americans are more willing to accept veneered furniture as an equal, if not better, to furniture made from solid wood. This transformation has happened for several reasons.

Why Veneer Survives & Thrives

First, technology has improved. Core materials have improved tremendously, including the introduction of MDF. Space-age glues and vacuum technology have simplified the pressing process. Second, veneer as a material is green by design—it's durable, renewable and sustainable.

Today most exotic woods can be purchased only in veneer form, and in the future I wouldn't be surprised if all imported lumber will be available only as veneer. And we can't overlook the different ways veneer can be cut: rotary, sliced and half-round. These cuts create sequenced veneers that offer incredible figure, color, texture and variety.

Third, veneer is easy to ship, handle, cut, seam, flatten, shade and repair. Veneer bends well and can be used for panels, bandings, edging and inlays. And last, a correctly balanced veneered plywood panel is far stronger than solid wood of the same thickness, which means furniture can be made with a savings in material, weight and cost.

Solid-wood construction has some limitations; it is subject to shrinkage, warping, splitting, twisting, and insect and fungal attack. Veneer will not warp, twist or split and will not suffer from stresses or strains. There is no doubt that today's craftsman with modern techniques and processes can produce veneered furniture that is far more durable and every bit as attractive as the solid wooden furniture it has surpassed.

Veneer vs. Solid Wood Costs

In America today the average hardwood tree taken to the mill is around 9' to 10' long by around 17" in diameter. This "typical" tree will yield about 106 board feet of 4/4 lumber (according to the Doyle scale). That same size log will yield around 4,200 square feet of clipped veneer. (It is always hard to accurately compare veneer at a

square-foot size to lumber at a board-foot size, but these numbers are pretty close.) As we become more aware of efficiently using our natural resources, stretching a board truly is possible with veneer.



Slice of heaven. This wardrobe by the author shows how veneers can be combined with an attractive form to produce work that exceeds what is possible in solid wood alone.

From a financial standpoint, if the average price of a select and better piece of 4/4 cherry is \$7 a board foot; that would give that entire log a value of \$742. If the average price of a piece of select cherry veneer is \$1.80 per square foot, then that same log could generate close to \$7,500—around 10 times as much as lumber. Which way do you think the wood market is headed?

So unless you are timbering your own trees, working with solid wood in the future might not be a good choice. Don't get me wrong—hardwood will always exist because in America, according to the HPVA (Hardwood Plywood & Veneering Association), we plant 5.4 million trees a day. But you can bet that of those trees that reach maturity, veneer is the goal (or should I say gold).

The Slicing Process

Veneer-quality trees are the Holy Grail of timber logs and are typically higher in quality than logs for solid lumber. Domestic veneer logs are usually free of visible defects and have a clean, cylindrical shape with parallel sides. Once the log makes it to the veneer mill it will be sorted, graded and stacked into parcels. Logs are kept wet during the summer months in order to keep the bugs out and prevent fungus



A dream in wood. Using veneer allows you to create almost any effect you can dream up and to disregard many of the rules of wood movement. This bed was designed and built by the author.

from developing, which could affect the color. But most important, the wetter the log is, the less the ends will check. Once the log has been called into service it will first go to a machine that de-barks and de-butts the log (this cleans off the bark, dirt and gravel as well as makes the log more cylindrical). After the debarking process the log is X-rayed to make sure it's free from metal that could destroy the slicing knives.

Once the log is put into motion, a decision is made as to how it will be sliced: plain or flat, quarter or half-round. The sawyer then cuts the log into halves or quarters; then it becomes known as a "flitch." A large log can produce several flitches. A better definition of a flitch is a section of veneer log that is cut to yield the best figure. The freshly sawn flitch is then placed in a vat of hot water. This hot bath softens the lignin, which will make it easier to slice (and to a small degree the soaking process helps balance the sap and heartwood to a closer color).

After a few days to a few weeks, depending on the species, size, hardness or thickness, the flitch will be ready to cut. The flitch is typically brought to the slicing

area by an overhead crane where it is either fastened to a machine with dog-like clamps or held in place by a vacuum system.

The secured flitch is held at a slight skew to a knife that runs horizontal. The flitch then moves up and down in a shearing motion, which cuts the veneer into the pre-set thickness. With every stroke of the machine, the flitch moves forward by the same thickness of the veneer being cut at the rate of 80 to 100 cuts per minute. Each individual piece of veneer cut from the flitch becomes known as a "leaf."

Each leaf cut from the flitch is kept in sequential order and stacked as it was cut from the log. What is amazing about this process is that, if the flitch was 12" thick in solid form before cutting, the sequentially stacked veneer after cutting will still be 12" thick. There is no thickness lost.

The sliced veneer is then sent one leaf at a time through a drier. It takes about 45 seconds for each leaf to pass through the oven, but once through, the veneer is dry (normally around 6 to 8 percent moisture content) and ready for market. The remarkable thing about this process is that from the day a tree is cut in the woods to the day it is ready to use as veneer could be

just over a week or so. Hardwood lumber, on the other hand, could take up to a year to be ready to use.

The Thickness of Veneer

I have a friend who sticks out his chest with pride as he tells people, "I work only with solid wood." Actually, veneer is a solid wood – it's just really thin.

Today in America, depending on species, veneer is cut somewhere between $\frac{1}{42}$ " (0.6mm) to $\frac{1}{50}$ " (0.5mm) thick. Currently, $\frac{1}{42}$ " is typical. What this means is, that for every board foot of wood, we can get 42 pieces of veneer – enough to cover the face of a sheet of plywood plus one-third of its back side.

The cut of veneer just gets thinner and thinner. Not too long ago veneer was cut $\frac{1}{28}$ " thick, then the standards changed to $\frac{1}{32}$ ", then $\frac{1}{40}$ ". Today in Europe they cut veneer between $\frac{1}{54}$ " to $\frac{1}{60}$ " thick, and I've heard some Asian countries cut to $\frac{1}{120}$ ". The thickness of raw veneer varies from 0.019" to more than 0.025". Veneer thickness can vary within the same log.

Domestic species are sometimes cut to different thicknesses, so maple might not be cut the same as walnut, not to men-



Ground to round. Within about a minute, this machine can strip the bark off a full-size log and get it ready for slicing on an enormous band saw mill.



Primordial pool. These deep pools of hot water soak the logs to soften the wood for slicing. The smell is surprisingly powerful, like a primeval swamp.

tion that each veneer mill cuts to different thicknesses. Exotics or imports are different in thickness than domestic veneers. What this means is, that as you match one veneer to another, you will more than likely have some variances. For the most part this will not be an issue. After pressing and sanding, those differences seem to go away.

Keep in mind that the thinner the veneer is cut the more fragile it will be and there are risks of glue squeezing through the thin pores. In some cases with light colored wood that is quite thin, the dark color of the coreboard could show through the face veneer.

Types of Veneer Cuts

The way veneer is cut can greatly affect its appearance. Two logs of the same species can look entirely different even though their colors and grains are similar. In veneer manufacturing there are several ways veneer can be cut. The three most common ways are rotary, plain or flat sliced and half-rounding.

Rotary: Rotary cutting is the only cutting method that is capable of producing whole-piece faces. Rotary is used in

the majority of stock panels produced in North America and yields the most veneer per log. The log is mounted in a super-sized lathe and turned against a stationary knife. The veneer comes off the blade like unrolling a roll of toilet paper. Because rotary cutting follows the annual growth rings it creates a very broad grain pattern that doesn't look like plain or quarter-cut wood. Rotary-cut veneer is generally less expensive than sliced veneer.

Plain or Flat Sliced: Plain slicing (sometimes referred to as flat slicing) is the cutting method most often used to produce veneers for quality architectural woodworking. Slicing is done parallel to a line through the center of the log. This cut produces a combination of cathedral and straight grain patterns. This is the common way veneer is cut for creating both book- and slip-matching.

Half-rounding: Half-round cutting is a variation of rotary cutting that produces more of a plain-sliced cut. The flitch is mounted off-center in the lathe. The lathe rotates with the flitch brushing against the stationary knife. The resulting cut is somewhat similar to both rotary and plain-sliced veneers. Half rounding is the

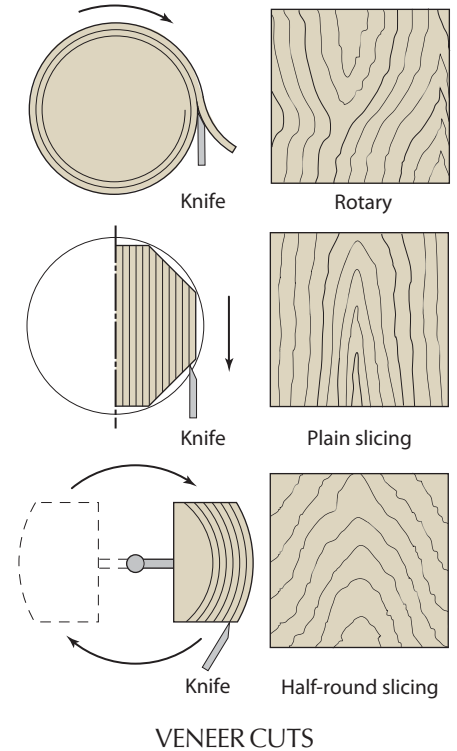

best way to enhance characteristics such as bird's eye and curly wood. Burls are commonly cut by half-rounding.

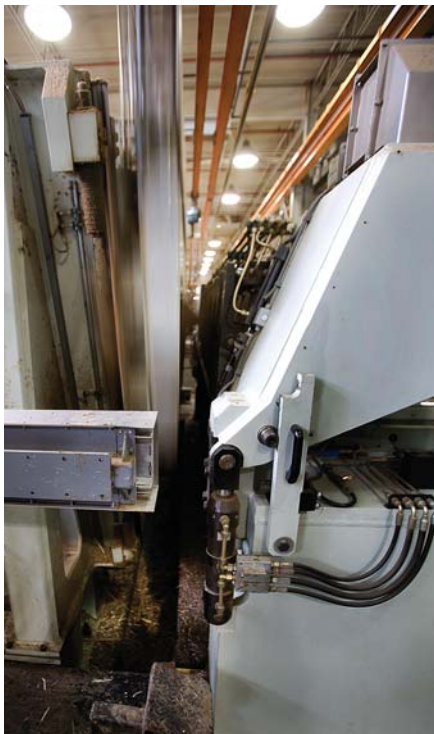

Too fast to see. The blur on the left is a log being moved rapidly up and down in front of a stationary knife that is slicing off perfect leaves of veneer.



Almost done. Employees at Danzer Veneer in Edinburg, Ind., inspect the leaves as they travel from the slicer to the be dried.

Unique Veneers

Veneer has natural characteristics that are sometimes considered flaws but when cut and sequenced together create some beautiful and unique effects.

A common fallacy is to refer to the word “grain” as a way of describing how the wood looks. Actually grain is the way to describe the natural arrangement of the wood fibers in relation to the main axis of the tree. The correct term when trying to identify the characteristic of the natural features of wood is to use the word “figure.” Veneer is the best way to showcase specific figure considerations such as curly, spiral, quilted, wavy, straight, cross, quartered, rift and diagonal. Other terms for veneers can sometimes be confusing and need to be better defined, including crotch, burl, butt, mottled, bird’s eye, beeswing, fiddleback, blistered or quilted – to name a few. It is also important to understand what reconstituted veneers are.

Purchasing Veneer

Like anything, buying in volume is the way to go. However, the manufacturers of veneer will not sell you one leaf at a time. Several years ago some of the larger manufacturers would sell veneer only by the container. Today buying veneer is a bit easier and some manufacturers will sell a log or sometimes even an individual flitch at a time. Be aware that a flitch can

still have well over a thousand square feet of veneer.

Also remember that a flitch is shaped like a half of a log, so you will be buying veneer where each leaf will be a little wider than the one next to it. Fortunately there are several small distributors who purchase from the manufacturers and break the flitches into bundles or individual leaves. There are a lot of these companies around and a Google search will help you find a company in your area. Probably one of the most reputable companies is Certainly Wood in East Aurora, N.Y.

Always be specific when purchasing veneer. Ask for a certain size, both length and width, and try to define the type of figure and color you are looking for. Remember that you always want sequenced veneer from the same flitch. Usually the leaf packets cut from each flitch get bundled in groupings of 24 or 32 sheets. If you are purchasing veneers such as burls and crotches you might ask for conditioned veneer or the flattest that they have on hand.

Veneer Grading

Most people assume that veneer has the same grading standard as solid wood, but that is not the case. For example, veneer does not follow the normal nomenclature of lumber such as select and better, face and better, No. 1 common and so on.

The manufacturers decide the qual-

ity of each flitch depending on the overall size, natural defects, milling defects, color, demand and overall appearance. The manufacturer can pretty much give each flitch any grade value they deem accurate, and it is then sold to distributors or retailers.

In other words, the distributors or retailers can negotiate what they want to pay, and like a used-car salesman the manufacturers will find a deal that fits their budgets. Once a distributor or retailer buys a flitch to resell, they have the option to give any grade they want to each leaf. Grading becomes arbitrary to the seller. What happens is these guys buy specific flitches and pull out the wider pieces and give them one price while placing a lesser value on narrower or less desirable pieces.

This is why you will find a great deal of variance from one retailer to another on both price and quality. Always buy veneer from a company that offers complete customer satisfaction. Remember that veneer (like lumber) is a natural product with complex and varied properties. What you think cherry should look like might be different from what the retailer has. It might be a good idea to ask your retailer to send you a photo before you make your purchase.

Handling & Storage

When you get your veneers they will be shipped either flat or rolled. If they come rolled up, unroll them as soon as you get them. If they remain rolled up they will take on a rolled or curved shape. This will not hurt the veneer, but it will make cutting and taping more of a challenge.

Inspect each sheet for shipping problems, natural flaws or manufacturing defects. Although veneer is lightweight it is always a good idea to have someone help you handle long pieces – even if it is just one leaf. I use a piece of chalk to number each piece as they were stacked to remind me of the correct sequence. It is also a good idea to tape the ends of each individual leaf to help keep it from tearing with the grain. It is essential to handle veneer as little as possible. Each time veneer gets handled there is a risk of splitting.

Veneer is best stored in a flat position with some kind of weight on top. The environment should be well ventilated, consistent in temperature and relatively dry (around 70 percent humidity). If possible,



Unroll and use. Veneer typically comes rolled up or flat. If it's rolled, you should unroll it as soon as you can. Here Zane Powell (right) gives the author a hand with some walnut veneer.

Common Veneer Figure



Fiddleback

Fiddleback gets its name from its customary use on the back of fiddles. Fiddleback is typically cut from quarter-cut wood with straight grain, which helps the stripes to run nearly perpendicular to the main figure. This gives the stripe an almost continuous line from one edge to the other.



Bird's Eye

This delightful figure is self explanatory. Bird's eye is most commonly found in maple but sometimes occurs in other species. Wood with bird's eye is usually rotary cut, which helps distribute the bird's eyes more uniformly. Bird's eye is graded according to the density of the figure in a specific area.



Butt or Stump

Butt or stump wood typically comes from the base or stump of a tree, sometimes the area below ground level. The fibers are twisted and tend to wrinkle, which gives a wavy or rippled marking.



Mottled

Mottled figure is a wrinkly and almost blotchy appearance. It features a great contrast of light and dark areas. It can often be scattered randomly and often resembles a checkerboard pattern.



Quilted

Quilted and blistered figure are very similar. It is commonly found in mahogany and maple and is best known for its three-dimensional effect. It almost looks like a plume of billowing smoke that is bulging out.



Beeswing

Beeswing is very similar to the mottled effect. This figure resembles a beeswing and can be found in almost any species, but satinwood is one of the most common woods for beeswing patterns.



Burl

Burls are large, wart-like growths on either the lower part of the tree close to the ground or on the trunk of a tree. These are usually caused by an injury under the bark, which makes the cells divide and grow excessively. Burls create beautiful wood and have the appearance of tightly clustered dormant buds, each with a darker pith. Burls really don't have grain direction like typical wood, which causes them to ripple and distort. Most burls need to be conditioned (flattened) before they are cut. It is also typical for burls to have knots, cracks and lots of voids that will need to be patched or repaired.



Crotch

A crotch is the part of the tree just under a fork, branch or split where the main branch joins the trunk. During growth the tree fibers begin to suffer from reaction to either compression or tension caused by the weight of the limb. The result is a very distinctive "flame" or "feather" figure that is elliptical in outline but with a strong central plume. In fine furniture this flame is usually inverted so that it appears upside down from the position that it grew in the tree.



Reconstituted Veneer

Reconstituted veneer (or composite veneer) is created by rotary slicing inexpensive logs from fast-growing trees, then bleaching, dyeing and gluing slices together over unique molds or shapes to create big blocks with specific shapes. These blocks are then re-sliced, re-glued and re-cut to create imitations of patterns from natural wood. They are remarkable in how close they come to the original species they are intended to match. This veneer is somewhat brittle, which makes it a challenge to cut. Because of the glue used in the manufacturing, it can resist stain, and it is difficult to achieve book and slip matches.

try to wrap your veneer with dark plastic, such as a trash bag. This will help keep the veneer at a constant moisture content while protecting it from the environment. Light can quickly discolor veneer, so at all costs keep your veneer away from windows or certain types of house lights.

Flattening Veneer

Just like solid wood, veneers can have flatness issues. With solid wood the technique to make boards flat is through the milling process; with veneer it is through

the conditioning process. Conditioning is the process of taking veneer that is buckled, wavy or overly dry and restoring it to a flat, smooth workable condition. There are two common ways to flatten veneers—one is temporary the other is permanent.

Method 1: For veneers that have a slight wave or buckle, you can just use a spray bottle with distilled water and lightly spray it on both sides (do not soak the wood). You can then use an iron on a medium setting and iron the veneer flat. Or better yet, just put it between two caul boards and

clamp it overnight. It might be a good idea to put some paper towels between each piece of veneer to help pull the additional moisture out of the veneer.

This is a temporary way to make veneers flat. The flattening effect will last only long enough to get the veneer cut to size, glued to the core and stuck in the press.

Method 2: For those veneers that are brittle, buckled or cracking (typically burls and crotches) a sizing solution can be made and applied that will help to flatten and soften veneers for an indefinite period of time. There are a lot of variations of this solution, but they all do basically the same thing.

My solution consists of distilled water, white glue, glycerin and denatured alcohol. Once it is mixed the solution will have a shelf life of a few weeks, so it might be best to throw out what you don't use and mix new next time you need it. I use white glue because it adds additional strength to the veneer fibers, and once the sized veneer is flattened, the glue will help keep it flat. White glue also dries clear, so it will not color the veneer as yellow glue and resin glues will.

Glycerin is hygroscopic and will help

Mix and brush. Sizing solution helps flatten your veneers and keep them that way. Mix the ingredients (right), then brush the solution on both faces of every leaf (below).



soften the veneer, make it pliable and help keep it from cracking. Do not use too much glycerin—it ultimately can affect the glue-ability of the sized veneer. (Glycerin is available at any pharmacy or tractor supply store that sells animal supplies.) Distilled water thins the glue and helps the solution draw into the fibers of the veneer. Denatured alcohol acts as an emulsifier between the white glue and the glycerin. Denatured alcohol also helps the solution dry faster.

Thoroughly mix all ingredients. The mixture should be used cold. Use a spray bottle or brush to cover both sides of the

THE MIX

- 4 parts distilled water
- 1 part white glue
- 1 part denatured alcohol
- 1/2 part glycerin

veneer with the sizing solution. It might be a good idea to use clothespins and hang the veneer to let the solution penetrate for about 30 minutes. This will also help the alcohol and water begin to dry. The veneer

Press flat. Layer the sized veneer with fiberglass screen and paper towels (right). Then use cauls and clamps to press the sandwich flat (below).



should feel somewhat dry and quite pliable within that amount of time. If I am flattening several pieces of veneer, I will do them all at the same time.

The sized veneer needs to be pressed. However, if you put the veneer in the press in stacks you will do an excellent job of gluing together a stack of veneer. (Remember—the sizing solution has glue in it.) It might be a good idea to get some fiberglass screen material and, for their first six hours in the press, sandwich each piece of veneer in the following arrangement: paper towel, screen, veneer, screen, paper towel, screen, veneer, screen, paper towel and so on.

It would be a good idea to change out the paper towel in the press every two hours. This will help draw more moisture from the veneer and help the glue dry. After about six hours in the press, remove the screens and paper—but it's still a good idea to separate each layer of veneer with a piece of plastic. (Avoid using waxed paper because under pressure some of the wax could transfer into the pores of the veneer, which could cause gluing problems down the line.)

Place the veneer back into the press and let it sit for at least 24 more hours. If after that time the veneer still feels wet, keep it in the press until it is dry to the touch. By the end of this process, your veneer will be flat, smooth and ready to turn into works of art. **PWM**

Marc is the founder of The Marc Adams School of Woodworking (marcadams.com), North America's largest woodworking school. You can send him an e-mail at marc@marcadams.com.

Go Online FOR MORE ...

You'll find links to all these online extras at:

► popularwoodworking.com/oct10

VIDEO: Watch a video tour of our visit to the David R. Webb Veneer Mill.

BLOG: Read Robert W. Lang's blog entries about his visit to a veneer mill.

WEB SITE: Visit the web site for the Marc Adams School of Woodworking.

TO BUY: Get veneer from *Certainly Wood*.

IN OUR STORE: "The Woodworker's Guide to Veneering & Inlay."

All of our products are available online at:

► WoodworkersBookShop.com

Magobei's Dining Table: Part 2

BY TOSHIO ODATE

The fear of a sagging tabletop leads to a solution that incorporates Western joints and Japanese aesthetics.

Many countries have their own woodworking traditions, which are often a combination of mythology and ideology. The Japanese are no exception, and those traditions are part of the foundation of my work.

There is a temple that ancient Japanese carpenters built. Its columns, hewn from trees, are positioned as when each was a standing tree. That is, the south side of the standing tree, when used as a column, also faces the south.

Though the tree's south side has more knots, period Japanese carpenters believed that, if these trees had faced the sun for 1,000 years, as columns they would stand another 1,000 years if positioned the same.

Japanese woodworkers also try not to use wood upside down, even on small objects. And the heart side of the wood should always face the inside of a carcass or object. As a result, Japanese carpenters do not bookmatch material. Even for table legs, the core side should face the inside.

I follow these traditions as much as possible, especially the ideology used to indicate the two lives of a tree. Today, when making a sculpture or cabinet, I use materials that mostly come from my surroundings. There must be a strong reason to make an exception.

I don't just hope—I carefully construct a table to exist at least 300 years.



Joinery-palooza! By itself, the table highlights many seldom-seen joinery details. With the addition of the drawer frame and drawer joinery (including the author's unique technique for drawer dovetails and stacked mortise-and-tenon joints), this project could be used to illustrate a joinery encyclopedia.

Completing the Base

The Magobei's table was still upside down on the horses with the sliding beams protruding from the table. My assistant (who

"Problems are to the mind what exercise is to the muscles; they toughen and make strong."

— Norman Vincent Peale (1898 - 1993)
American Protestant clergyman and writer

did most of Part 1 of this article in the August 2010 issue), Laure Olender, sawed all four ends flush with the table's edge. She chamfered the corners and planed the end grain.

The dovetail joints fit tightly into the top, but I noticed a hairline crack on the bottom face of the top. Laure inlaid a small oak butterfly across it. The top face had a couple wider splits, so again butterfly inlay was used—one inlay bridged two small cracks.

We sharpened the power planer blades for the final touch up. Laure then used a palm sander and three sanding grits for the final preparation. The table was wiped with a dry cloth before a coat of Danish oil was applied. The table was beautiful and elegant. We were satisfied and Laure was happy.

Concern About a Design Flaw

A few days later, I studied the table, and one concern came to mind. This top is about 33" wide, 2" thick and 108" long. Between the legs there is about 73". With time, the middle might sag. But I did not want to add a brace.

A week passed and my concern became serious. I decided to put drawers below the top – the frame would keep it from sagging. At first, Laure thought it might destroy the table's elegance. But she realized there was not much of a choice. While her work on the table was perfect and the result beautiful, there was work to do.

Double-duty Added Structure

It was difficult to design the drawer structure, as the table was not made to have



Old-school fix. Any small hairline cracks in the tabletop are bridged with inlaid butterflies. On the bottom face of the tabletop, we use a matching hardwood, but any splits in the top face are fixed with a contrasting wood. (We used purple heart.)



Long-lasting joinery. The center dividers join the rails with wedged mortise-and-tenon joints. The top tenon, to be pared flush after the wedges are installed, extends above the rail while the bottom tenon is blind wedged – a technical joint that is as strong as a tree.

drawers. Here were the challenges: I did not want to destroy the elegant look; a person should be able to sit comfortably with his legs below; and the drawer frame structure needed to be designed. Here were my solutions: The drawers are constructed with Western joints but should simulate traditional Japanese design; all the parts should come from the exact same tree; and the drawer handles should be hand-forged in a Japanese style.

I want this table to last at least 300 years. In traditional Japanese woodworking, nails were used to fasten most drawers, even the large chest of drawers known as “tansu.” However, tansu were made out of paulownia, a soft wood that has no strength to hold metal nails. Japanese woodworkers used tapered wooden nails made of Japanese boxwood; rice glue held the nails in place. (One of the greatest enemies for wood is metal rust. If I have to use metal, I choose stainless steel.)

For that reason, I used joinery to secure the structure of the drawer frame instead of nails or screws.

Building the Frame

The drawer frame is a series of multiple-piece rails connected with mortise-and-tenon joints. The two outside rails have top and bottom pieces separated with five short dividers per rail. The center three dividers are set with the wide faces parallel to the rails while the end dividers are perpendicular to the rails. The center dividers have wedged through-tenons at the top, and blind, wedged tenons at the bottom. The end pieces have blind tenons



Built for strength. Three pieces stack to make up the center rail. The top piece has twin tenons, the middle piece has two tenons that stack vertically and the bottom piece has only one tenon, and that single tenon is blind-wedged.



Great grasp. A properly fit mortise-and-tenon joint is very strong. The center-rail-to-end-rail joinery has five such joints.



Four-pronged support. The end rails of the drawer frame not only attach to the dividers with mortise and tenons, the ends are notched to fit around the top and bottom pieces and the rail is tenoned into those pieces for additional support.

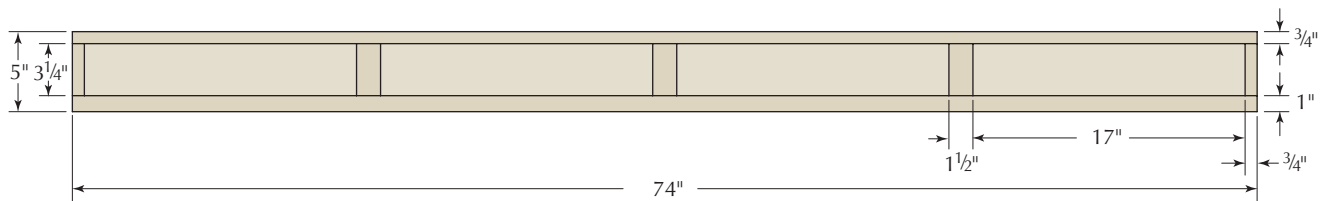

FRONT VIEW

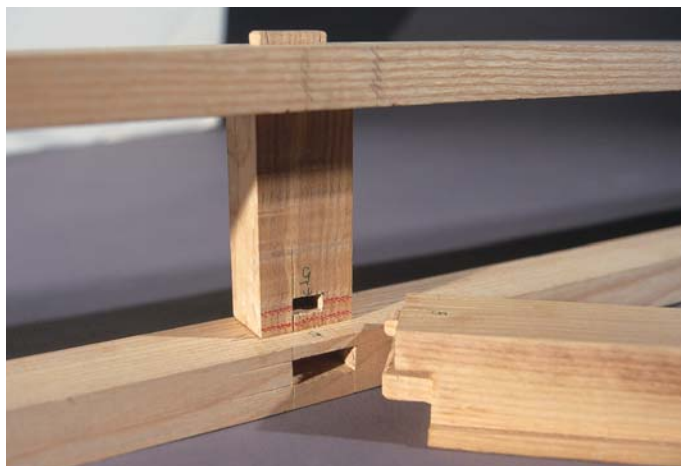

It's stronger than the rest. The design of the support is such that a portion actually rests on the bottom piece of the outer rail. Along with the mortise-and-tenon joinery, this rail has added support.



It's an easy fix. Because drawer runners receive a good deal of wear, it is advisable to allow for simple replacement. The runners are held to a support with stainless steel screws, no glue.

at both the top and bottom that are held with glue only, no wedges.

The center rail is made from three pieces that, when assembled, form an I-beam. The center part is attached to the upper and lower pieces with a sliding dovetail across the length of the rail, and each end is fit into the end rails with two tenons.

The upper piece of the center rail is attached to the end rail with a pair of split tenons, one on each side of the sliding-dovetail socket. The bottom rail has a single tenon fit to the end rail; blind wedges hold the joint secure.

The two end rails are mortised to accept the center rail's tenons, and they have tenons that fit into mortises in the end pieces of the outer rails. The end rails are also notched to fit around the outer rails' top and bottom pieces, and tenons are formed on the end rails to fit matching mortises in those pieces. Dry-fit these joints, but do not yet glue them up.

Drawer Guides With a Twist

Study ancient furniture with drawers and you will see that the drawer runners show most of the wear. To help make this table

last, it is important to allow for the replacement of those runners. For that reason, the runners are attached with screws, and if you carefully align the holes, the first fix is simply to flip each runner then re-install the screws.

The runners at the end of the drawer frame are attached directly to the end rails. The interior runners are attached to support pieces that fit between the outer rails and the center rail. These supports are joined to the rails with mortise-and-

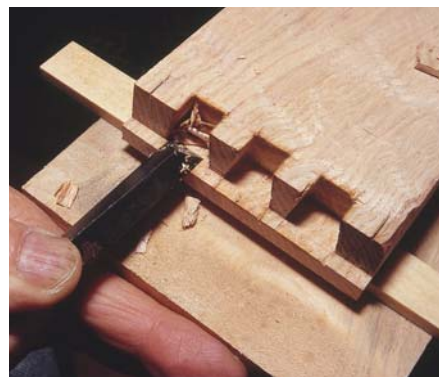

This looks familiar. The dovetail sockets on the drawer fronts begin as if the drawers were of a lipped design.

tenon joints. Each support piece begins as a length of stock that is 2" wide and 1⁵/₈" thick. The sides of the support are rabbeted, leaving a 1/4" x 1/4" ledge to locate the runners.

The photo above shows how the support fits to the front-rail assembly. Each interior support tenons into the bottom piece of the outer rail, then a portion of the support fits on top of that rail and tight to the divider, where a small tenon fits into the divider. Each support is fit to the center rail in the same way, except the upper tenon slips into the center part of that rail. After the drawer runners are cut to size and attached to the supports, the entire drawer frame is attached to the underside of the tabletop with screws.

On to the Drawers

For these drawers, I decided to use hidden dovetails. Hidden dovetail joints for dining table drawers? One might consider this overkill. However, I have good reasons.

First, Japanese woodworkers usually hide joints. For example, they mostly use blind mortises for interior work (although they would use through-mortises for an exterior door). Also, they hide intricate

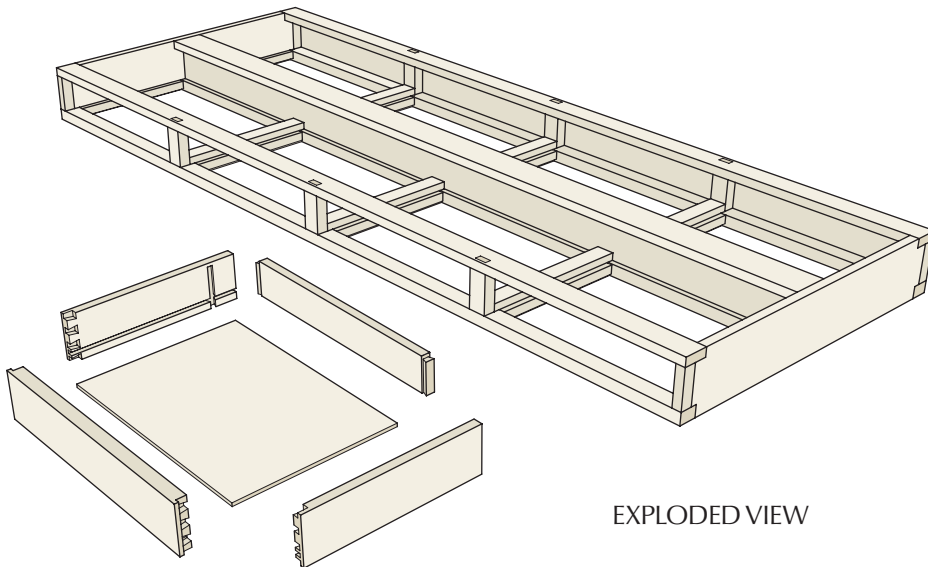

EXPLODED VIEW

Ash Table – Drawer Frame & Drawers

NO.	ITEM	DIMENSIONS (INCHES)			MATERIAL	COMMENTS
		T	W	L		
DRAWER FRAME						
□ 2	Outer rail bottoms	1	1½	74	Ash	
□ 2	Outer rail tops	¾	2	74	Ash	
□ 6	Center dividers	1	1½	4¾	Ash	¾" TBE*
□ 4	End dividers	¾	1	4½	Ash	½" TBE
□ 1	Center rail top	¾	3	73¾	Ash	⅝" TBE
□ 1	Center rail bottom	1	2	73¾	Ash	⅝" TBE
□ 1	Center rail middle	1	3⅞	73½	Ash	½" TBE
□ 2	End rails	¾	5	27½	Ash	¾" TBE
□ 6	Runner supports	1⅝	2	13	Ash	¼" TBE
□ 16	Drawer runners	½	¾	11⅜	Ash	
DRAWERS						
□ 8	Fronts	⅞	3¼	17	Ash	¼" x ⅝" RBE**
□ 16	Sides	⅝	3¼	12	Ash	⅜" x ⅝" ROE†
□ 8	Backs	⅝	2½	16½	Ash	
□ 8	Bottoms	¼	11¾	16½	Ash	
□ 32	Geta	¼	¾	⅞	Ash	

* TBE = Tenon both ends; ** Rabbet both ends; † Rabbet one end

corner joints. As a result, only a miter line or shoulder line is visible.

Second, the outward appearance of my new-style drawer (which I think I will mostly make from now on) is similar to a traditional Japanese drawer – it looks like simple rabbet-joint construction, just without the wooden nails.

The drawer fronts are lipped at the ends and dovetail sockets are cut just as you would see on Western drawers.

It's the drawer sides that differ. When

viewed from the side, there is no visible dovetail. The tails that fit into the sockets are blind, too. It is more detailed work, but the look mimics Japanese construction.

For the drawer back, I also did not want to use nails. I used a sliding dovetail. I notched the leading edge of the tail and slid it into the socket from the bottom – the groove for the drawer bottom is ⅜" deep to allow access. The dovetail socket stops about ¼" from the top edge. In that way, you see only the shoulder line.

Mr. Ash

People don't like to cut down a tree, especially an old one. Owners devise ways to keep the tree from falling. Eventually, if the tree dies or becomes hazardous, people agree to cut it down.

Small branches are chipped; thicker branches become firewood. However, most people, because of the respect for its age, size, or because the tree carries memories, want something special done with the main part of the tree.

As a youth, I was taught to respect a tree as material for woodworking. Occasionally, people would call and say, "I have just cut down a large tree. It would be a shame to cut it up for firewood. If you can use it, you can have it." They wish to preserve the spiritual and physical richness of the old tree.

I have heard the story and history of many trees and have developed an attitude toward the aging of an old tree. I imagine their knowledge, experience, wisdom, character and dignity. Anything that I make from them, no matter whether it is something large or small, is done with the greatest deliberation and attention.

Some time ago, I met with a man to look at an ash tree that had fallen during a storm. The large ash tree was lying quietly, and already many kinds of bushes were blanketing its surface. The tree weighed several tons – as it fell, it must have shaken the entire forest. When it fell, part of the forest floor was ripped, leaving a giant scar on the ground. The tree appeared to have been peacefully sleeping on the forest floor for centuries.

The bark looked very healthy; on it many vines were clinging tightly. About 20' up from the roots a large branch stretched out to the left, and almost immediately thereafter another branch directed my eye up to the right. I call it a branch, but it was almost 30" in diameter. The midsection of the tree was easily 5' in diameter. I estimated it was 250 years old.

The lower portion of the tree was rotten and its underside had little bark. I suspected that side had no usable wood.

I examined the tree a little longer. Finally, I climbed on it and walked toward the end. I felt as if I were crossing a large log bridge above a deep valley. I could not see the ground. Overwhelmed by its mass and long life with hidden knowledge and wisdom, I decided to name the tree Mr. Ash. I felt a strong urge to preserve all of its character and dignity. I would make as many things as I could, large and small, while celebrating this tree with joy. The Magobei's dining table is from this ash tree. — TO



Here's the difference. Take a close look at the drawer sides. The tails of the sides are not through-cut, so when the sides join to the drawer fronts, the fit is flush to the edge of the fronts.



Slide & hide. The rear of the drawer is also a dovetail connection, but it is a sliding joint. The dovetail on the drawer back fits into a stop-cut socket in the drawer side. As a result, the joint appears as a simple butt joint.



Boxes are built. Solid wood drawer bottoms adjust with the seasons. Align the grain to run side-to-side and glue the bottom to the drawer front to force any movement toward the back. The bottom has two screws (set in slots to allow movement) to keep the bottom from sagging.



Goodbye concerns. Not only does the drawer frame reduce the potential for the large tabletop to sag, the drawers, with the appearance of Japanese construction and Western joinery, add valuable storage.

The bottom panel's grain is parallel to the front face of the drawer. The panel is glued into a groove in the drawer front. In the event the panel shrinks, it would do so from the back edge toward the front. I hold this panel with two screws into the drawer back, set into $\frac{3}{8}$ "-long slits to allow the panel to move.

I added two "geta" to each drawer side to protect against wear (see "Geta: A Life Extended" on next page). These are tapered sliding dovetails tapped in from the outside and glued. They are flushed with the outside edge of the drawer side. By sliding the geta in from the outside (with the taper facing the inside), the pieces stay in place if the materials shrink.

Hardware & Finish Completed

After the drawers are constructed, we decide on the hardware design. The design is distinctly Japanese. The pulls feature a traditional installation method. The handle is centered and small holes are drilled for the cotter pin fasteners. Before I install the pulls, a coat of Danish oil was applied to the drawer fronts.

With the frame and drawers assembled and ready to use, I don't worry about the top sagging. The drawer frame adds support, and the drawers are useful. The table remains beautiful and elegant. **PWM**

As an author, lecturer and teacher, Toshio has been pivotal in spreading knowledge about Japanese tools and woodworking techniques throughout the Western world. He is a sculptor, woodworker, former professor at Pratt Institute, and the author of "Japanese Woodworking Tools: Their Tradition, Spirit and Use" (Linden) and "Making Shoji" (Linden).

Go Online FOR MORE ...

You'll find links to all these online extras at:

► popularwoodworking.com/oct10

VIDEO: Learn to calculate the sizes of the drawer parts needed for your project.

ARTICLE: Discover how to sharpen your chisels properly from long-time sharpener and author Ron Hock.

WEB SITE: Study the Tansu style and read about the history of the Japanese chest.

TO BUY: Purchase a set of Japanese chisels and other woodworking tools.

IN OUR STORE: Pick up "The Drawer Book" for information about drawer construction.

All of our products are available online at:

► WoodworkersBookShop.com

Geta: A Life Extended

After studying sliding doors in Japanese furniture, I considered how to use geta – small dovetailed pieces that reduce wear in door rails – in drawer construction.

This drawer construction technique is a new idea. The pieces are easy to make and once installed, they increase the longevity of the drawer sides through reduced wear.

Drawers ride on the geta – made from a denser lumber – and that keeps the sides from wearing prematurely. — TO



1 Custom miter box. A simple miter box makes sawing the geta quick. Clipped small brads act as feet to hold the jig in place.



2 Repetitive cuts. With the saw kerf made to the layout line, it's easy to produce the needed number of geta, four per drawer.



3 Consistency is best. Set up and cut the pieces close in size. While it's not necessary to get them exact, large variations within the drawer would become apparent.



4 Accuracy counts. Because the individual pieces may vary in length, it's best to mark each socket using the geta that is to fit the socket. Square the lines across the drawer sides.



5 A second jig. Use the miter box to make a layout jig. Due to the number of lines needed, a jig increases your accuracy as you transfer the lines to the drawer side faces.

6 Proper planning. It is easier to saw the sockets (taper pointing toward the drawer inside) without the drawer bottom in position. However, I developed the idea after the drawer boxes were completed. I also would change the location for the drawer bottom groove to provide for a thicker geta if I were beginning the drawer construction process.



7 Opening the socket. Careful paring with your chisel opens the socket. Check the fit of the geta often to achieve a snug fit.



8 Assembly. Add glue before seating the tight-fitting geta into the drawer side. Installed from the outside face, the geta stays put even if the drawer parts shrink.

9 Installation is complete. The relationship of the geta to the drawer box is shown here. Because they are made from lumber that is more hard-wearing than the drawer sides, this small addition allows the drawer to function properly for a longer period of time.



Where Does the Glue Go?

BY ROBERT W. LANG

Thirst, not starvation,
leads to weak glue joints.

On my first day on the job as an apprentice cabinetmaker, my task was to glue together radiator panels for an office building. Two sticks of solid wood with tongues on one edge fit into grooves on the edges of veneered MDF panels. Eager to show that I wasn't a complete boob, I said, "The glue should squeeze out so I know I have enough, right?"

The cabinetmaker training me looked me up and down and said, "The glue should almost squeeze out." I thought he was asking for the impossible as I set to work. There were a lot of panels to practice on, and plenty of time to think. Six weeks and 1,300 panels later, I was done. I got pretty good at laying down a bead of glue that just barely squeezed from the joint and every now and then I hit the "almost squeeze out" target.

Most of my motivation to apply the perfect amount of glue came from dealing with the consequences of too much glue – patches that wouldn't take stain due to wiping off the excess with a wet rag or chips in the veneer from scraping off little beads that I allowed to dry on the surface.

Over the years, I applied this principle to all my joinery. I read magazine articles recommending the use of copious amounts of glue to avoid "starving" the joint. When I worried about that possi-

"Nothing is softer or more flexible than water, yet nothing can resist it."

— Lao Tzu (6th century BCE)
founder of Taoism



How – not how much. Roughly equal amounts of glue were used in each of these joints. The difference between them is in how the glue was applied.

bility, I would put a joint together then take it apart to see where the glue was. If I saw glue on both surfaces I was happy; the joint would hold and I wouldn't have a mess to clean up.

My methods were successful. I can't remember having a joint fail for want of glue. Most of my experience is in production work, where time is money. I wasn't wasting time brushing glue on every possible surface before assembly and I wasn't spending time cleaning up after. But was I doing the best work possible?

Enter Glen the Careful Gluer

I share the magazine workshop with people whose work I admire, even though they use different techniques. When Senior Editor Glen D. Huey joined us, I noticed he had a different approach to gluing. He

almost always spread glue on both surfaces of a joint with an acid brush.

Both Glen and I have been around long enough to be set in our ways, but we each recognize that in woodworking there are usually several acceptable ways to accomplish any task. Glen made me wonder if there was an advantage to brushing glue inside a mortise, or if he was taking more time than necessary.

Think of what he could accomplish with the time saved by simply squirting glue in a mortise and moving on, as I did. So, I set up an experiment to prove him wrong. I prepared a piece of wood with three mortises, then sliced off one face of the board and attached a piece of Plexiglas. That way we could see what happened when the joint was glued and a tenon inserted.

A Great & Noble Experiment

One mortise would be glued with my method, one with Glen's and we decided to apply glue to the tenon alone for the third method. We set up our still and video cameras to record what happened. I squirted a bead of glue on each edge of the first mortise, inserted the tenon, then handed the glue bottle to Glen.

Glen squirted glue in the mortise, then with a brush spread the glue on the mortise sides and the tenon before he assembled the joint. I put a bead of glue on the last tenon and inserted it. This last joint was obviously not as well glued; the rim of the mortise scraped off most of the glue as the tenon went past, pushing it to the shoulder where a lot of it squeezed out.

The other two joints looked remarkably similar; glue covered the Plexiglas thoroughly and a small amount squeezed out at the shoulder. It appeared that both methods worked and that brushing only added time to the process without any added benefit. We went to lunch and returned to see what the joints looked like after the glue had dried.

After an hour, there was an obvious difference. The brushed joint had an even film of dried glue visible on the entire surface of the tenon. My joint, where the glue had been applied as a bead, had a much thinner film. In some places it looked as if the glue had disappeared entirely from the tenon's surface.

Where Did the Glue Go?

A piece of wood may appear solid, but at a microscopic level, its surface is more

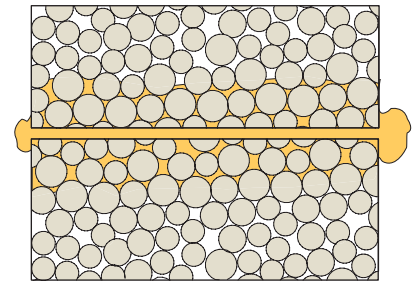
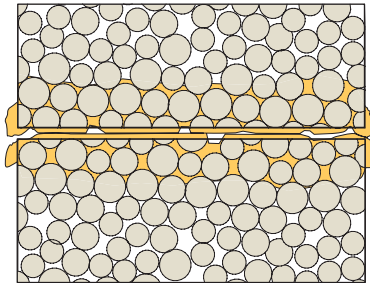

Saturation is the secret. Moisture in water-based glue penetrates the surface of wood. The joint at the left shows assembly from two dry components; the glue migrates away from the joint line. Spread glue with a brush and give it a few seconds to soak in for an effective bond, as seen in the illustration at right.

like sponge than stone. Water-based glues work by soaking into the surface to bond with the wood fibers. Glue on one piece combines with those fibers and with a film of glue on the adjacent piece. It takes time for the water in the glue to carry the other components into the wood.

This absorption takes place whether or not the two surfaces are in intimate contact. It isn't clamp pressure that forces glue into the cellular structure of the wood, it's the same process that takes place when you throw a pile of sawdust on a puddle on the floor. The water takes the easy route, soaking in where it can.

If there isn't a good film of glue on a joint's surface at the start, the glue that is present will likely migrate to the interior of the wood, away from the joint.

That's what happened to my mortise. A surface that looked completely covered lost a lot of glue – and a lot of glue strength – while we ate lunch. Brushing glue on both surfaces of the other joint saturated them. This is called wetting in glue par-

lance, and it allows the glue to distribute evenly when components are joined. On assembly, the glue on the wetted surfaces combines and forms a superior bond.

The amount of time it takes for wetting is only a few seconds, and the difference in the amount of glue used is small. My glue joint wasn't starved, it was thirsty. My method essentially spread glue on the mortise and the tenon at the same time; both parts were dry enough to absorb glue away from the contact area.

For optimum glue joints, you don't need a lot of glue, but you should spread the glue evenly on both surfaces before assembly and clamping. You can aim for an amount of glue that will almost squeeze out. Adding excess glue won't guarantee anything except a mess to clean up. But a few extra seconds spent spreading glue on mating surfaces will guarantee a better joint.

As I mentioned earlier, I've never had a mortise-and-tenon joint fail, but this simple test convinced me that I've been lucky. From now on, I'll take a little more time and brush on the glue. **PWM**

Bob is executive editor of Popular Woodworking Magazine; he owes senior editor Glen D. Huey lunch.



All wet. When a joint is first assembled, the glue spreads into any available space, whether it was brushed or not, as shown here in our first of several tests.

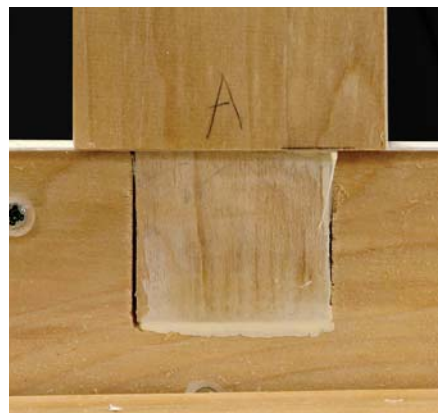

Moisture migration. Within moments glue is absorbed into the surrounding wood. In this unbrushed joint the glue moves into the surface of the tenon.

Go Online FOR MORE ...

You'll find links to all these online extras at:

► popularwoodworking.com/oct10

VIDEO: Three methods for gluing mortises compared.

BLOG: Read "Bound Up On the Topic of Glue."

IN OUR STORE: "Glue and Clamps (Missing Shop Manual)."

All of our products are available online at:

► WoodworkersBookShop.com

BY BOB FLEXNER

Optimize a Spray Gun

A simple test reveals ideal pressure for atomization.

Spray guns can run off a compressor or a turbine. With turbines the air pressure is established by the number of “stages,” usually two, three or four. Each stage corresponds to about 2 pounds per square inch (PSI). This seems ineffectively low, but it’s made up for by a huge volume of air, giving rise to the name – High-Volume Low-Pressure (HVLP).

With compressors you have an infinite range of pressures you can use, and it is up to you to set this pressure so your spray gun is optimized for the best possible atomization. If you use too little pressure, you won’t get the best atomization; you’ll get orange peel. If you set the pressure too high, you’ll waste finish or stain because of excessive bounce-back.

How to Determine Ideal Pressure

Some spray gun and finish manufacturers provide a suggested air pressure for their products, and you may find this works just fine for you. But there are many variables manufacturers can’t take into account. These include the actual finish or stain you’re using if the suggestion comes from a spray-gun supplier, how much thinner you’ve added, the length of your air hose, and a particularly critical variable for home shops – temperature variations (liquids become thicker in cooler temperatures and require more pressure to atomize).

In addition, manufacturer-suggested pressures often don’t specify whether they are measured at the compressor’s regulator, the gun’s air inlet or at the air cap.

In order to adjust the pressure at the air inlet or air cap, you need a pressure gauge that



Dots. One method of optimizing the air pressure to a spray gun is to increase the pressure until the dots at the edges of the pattern no longer get smaller. Increasing the PSI beyond this point only increases bounce-back. The air pressure on the left spray burst is 20 PSI at the regulator. The air pressure on the right spray burst is 50 PSI. The dots at the edges of the right pattern are significantly smaller and also more uniform in size than the dots at the edges of the left pattern.

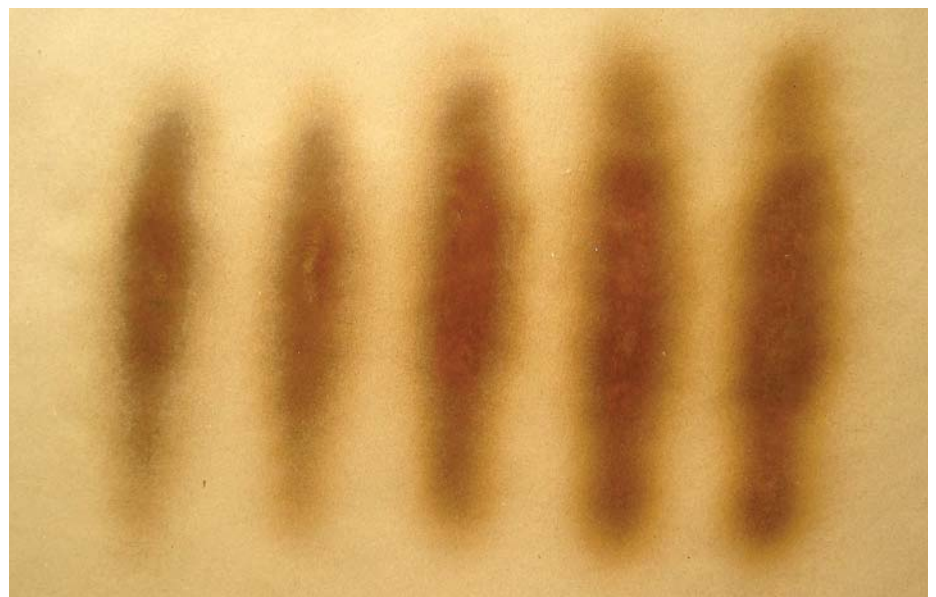

Pattern. A second and often more obvious method of optimizing the air pressure to a spray gun is to increase the pressure until the pattern no longer gets wider. “When the pattern is right, the pressure is right.” This picture shows increasing the air pressure in 10-PSI increments from 20 PSI at the regulator to 60 PSI at the regulator. The pattern doesn’t get wider from 50 PSI to 60 PSI, so spraying above 50 PSI doesn’t improve atomization. It just wastes finish material due to excessive bounce-back. Fifty PSI, or just a little less, is therefore the optimum air pressure to use with this gun and finish material at these temperature conditions.

With the right bit you're almost done

Over 1,000 Bits
to Choose From



RouterBits.com

Order Online or Call our Sales Team Today!

TylerTool.com 1-800-222-8404

www.RouterBits.com is a Division of Tyler Tool Company

For more information, go to PWFREEINFO.COM.

WHITECHAPEL LTD



Over 4000 fine hardware essentials

315 PAGE COLOR CATALOG \$5.00
1-307-739-9478 whitechapel-ltd.com

For more information, go to PWFREEINFO.COM.



Carefully Crafted,
Impeccably Designed

Wood turnings and components from
Osborne Wood Products, Inc.
are the perfect complement for your
woodworking projects.



www.osbornewood.com

866.963.5576

For more information, go to PWFREEINFO.COM.

WWW.RADARCARVE.NET
Wood Carving Duplicators

- Furniture
- Gunstocks
- Millwork
- Decoys
- Musical Instruments

Incredibly accurate



Thousands of Uses 505-948-0571

For more information, go to PWFREEINFO.COM.

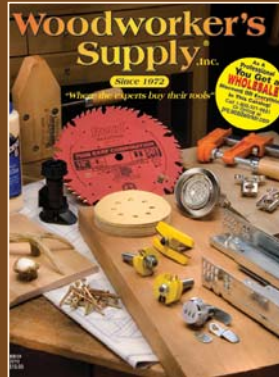

If you are in a
woodworking
business...
this could be the
most valuable tool
in your officesm.

Please call
1-800-321-9841
for your 800 page
catalog.

Mention code pw10
FREE
to woodworking
businesses.

visit us at pro.woodworker.com/pw10

For more information, go to PWFREEINFO.COM.

SINCE 1972
Hartville Tool
OHIO'S LARGEST TOOL STORE!

100 PC. For A Limited Time
Rare Earth Magnet Value Pack
Item # K10369
SAVE 60% Only!
\$15.98
Reg \$39.99
Offer Valid for 90 days

Special Value Pack Includes:
45 ea. 1/4" Magnet # 10369
30 ea. 3/8" Magnet #10370
25 ea. 1/2" Magnet # 10371

FREE! SHIPPING
On Orders Over \$99
(Lower 48 States)

FREE Catalog!
hartvilletool.com
800-345-2396

For more information, go to PWFREEINFO.COM.

✓Yes ✓Yes ✓Yes
✓Yes ✓Yes xNo
✓Yes ✓Yes ✓Yes

✓ Everyday Low Prices
✓ Easy To Use Website
✓ Huge Selection
✓ Fast Shipping

ROCKAUTO.COM
ALL THE PARTS YOUR CAR WILL EVER NEED
GO TO WWW.ROCKAUTO.COM ROCKAUTO, LLC (EST. 1999)

For more information, go to PWFREEINFO.COM.

CONTINUED FROM PAGE 54



Regulator. Both methods of optimizing the air pressure to a spray gun can be done with just a regulator, which is attached to smaller, portable compressors and is mounted on the wall with larger, stationary compressors. This picture shows air and moisture filters along with the wall-mounted regulator.

attaches to these locations. Many spray gun manufacturers supply an inlet air gauge with their gun. But the more accurate measurement is made at the air cap. Unlike the more generic gauges that attach to the air inlet, gauges for the air cap are specific for each gun and can cost several hundred dollars.

But you don't need any of these gauges, and you don't need to rely on manufacturers' suggestions. You can figure out the optimum air pressure for your gun and for the finish you're spraying with just the regulator and a simple test. (Portable compressors have a regulator attached. Larger compressors are meant to hook up to piping and you have to install a regulator at the point where you want your air hose to attach.)

The Test

To find the optimum air pressure, begin by opening all the controls on your gun to their maximum and turning the air pressure at the regulator down to well below where you think it should be – for example, to 20 PSI.

With the regulator set to about 20 PSI, spray a short burst onto brown paper or cardboard. (The finish shows up better on a brown surface than on white paper.) You'll get a relatively small, center-heavy pattern with noticeably large dots around the edges.

Increase the air pressure by 10 PSI and spray another burst. The pattern will be a little wider and the dots a little smaller.

Continue increasing the air pressure in

increments of 10 PSI and spraying short bursts. Each time you increase the pressure the pattern will get wider and the dots at the edges of the pattern will get smaller.

It's important to hold the gun at the same distance from the target for each burst. The easy way to do this is to open your hand fully, placing the tip of your little finger against the target and the tip of your thumb against the air cap on the gun. Then spray each burst at this distance, which is about 8".

When you reach a pressure that doesn't widen the pattern from the previous one and doesn't make the dots smaller, you've gone too far. You've achieved the best atomization, but you're now wasting material because more than necessary is bouncing back.

So reduce the air pressure to the previous setting – or a little further – to just before the pattern shrinks and the dots become larger.

This is the optimum setting for the viscosity of the material you are spraying in the current temperature conditions. Here's your mantra: "When the pattern is right, the pressure is right."

As long as the viscosity and temperature conditions remain the same, there's no reason to redo the test. Simply set the air pressure at the regulator the same each time you spray.

If you change to a different finish material, or if you thin it differently, or if the temperature changes, you'll need to perform the test again to find the optimum pressure.

But you shouldn't need to start over from a too-low pressure. You will learn quickly how to make simple adjustments, increasing the pressure a little when it is cold and decreasing the pressure a little when you have added more thinner.



Orange peel. When the dots at the edge of a spray burst are large, you get an especially bad case of orange peel as shown here. Orange peel is so named because of the resemblance to the texture in the peel of an orange.



Pressure gauges. Optimizing can also be done using a pressure gauge attached to the air-inlet nipple at the bottom of the gun's handle, but no advantage is gained over simply using the regulator. To determine if you are complying with the HVLP standard of not exceeding 10 PSI at the air cap, you will need a special air cap and attached air pressure gauge.

If you should want a wider fan pattern for spraying large surfaces, you'll need to get a larger fluid nozzle and needle. Then go through the optimization procedure again to set the air pressure.

Once you have established the optimum pressure for the equipment you're using, you can narrow the fan width a good bit using the fan-width control knob without losing significant efficiency.

Remember that this test doesn't work with turbine-air supplied guns because you don't have the same control of air pressure. For the most part, the only adjustment you can make using a turbine gun is adding more or less thinner. **PWM**

Bob's new book, "Flexner on Finishing," is now available at WoodworkersBookShop.com.

Go Online FOR MORE ...

You'll find links to all these online extras at:

► popularwoodworking.com/oct10

ARTICLES: Browse through the many stories available on our "Finishing" page.

TO BUY: Bob's new book, "Flexner on Finishing" (Popular Woodworking Books), is now available through our online store. The book is an indexed collection of Bob's updated and revised columns from the last 10+ years.

All of our products are available online at:

► WoodworkersBookShop.com

The Workbench Design Book



NEW

from
Christopher Schwarz & the
Popular Woodworking
staff

Christopher Schwarz &
the 'Popular Woodworking' Staff

\$34.99 • Hardcover
ISBN 978-1-4403-1040-9 • #Y1532

PRINTED AND BOUND IN THE UNITED STATES

Build Your Ideal Workbench

“The Workbench Design Book” is the companion book to Christopher Schwarz’s “Workbenches: From Design & Theory to Construction & Use.” Its 256 pages are chock-full of information on designing the ideal workbench for the way you work. You’ll get complete step-by-step drawings and instructions for building nine styles of workbenches, from ancient to thoroughly modern, with an in-depth critique of each:

- Authentic 18th-century Roubo
- Holtzapffel Cabinetmaker’s Bench
- LVL Workbench
- 21st-century Workbench
- Shaker Workbench
- The 24-hour Workbench
- Power Tool Workbench
- \$230 Workbench
- German Patternmaker’s Workbench

Plus, you’ll find information on modifying an existing workbench, workholding, tool storage and more. And, Chris critiques a wide range of common workbench designs with “before and after” illustrations to show what works – and what he’d change.

You’ll head to the shop armed with all the knowledge and plans you need to make the perfect bench for your shop, no matter what kind of work you do.

ORDER ‘The Workbench Design Book’ NOW

at WoodworkersBookShop.com, or call 1-800-258-0929.

(Shipping is free in the United States!)

Put the Past to Work in Your Shop

First printed in 1889, this book was written to educate college students in the craft and business of woodworking. The original text is reprinted in its entirety, not only to help you discover late 19th-century practices in woodworking, but to help you make the most of traditional hand tools in the modern shop. As you work through a series of 39 exercises, you’ll discover how to:

- Set up your shop and identify the tools every well-stocked hand-tool shop needs
- Effectively wield the most-used woodworking hand tools
- Use the various marking gauges like a professional cabinetmaker
- Sharpen your tools – from plane blades to saw teeth
- Mark and cut the most-used joints in furniture making
- Use a frame saw (the quiet answer to the modern band saw)
- Make a door and drawer
- Install cabinet hardware including hinges and locks
- And more

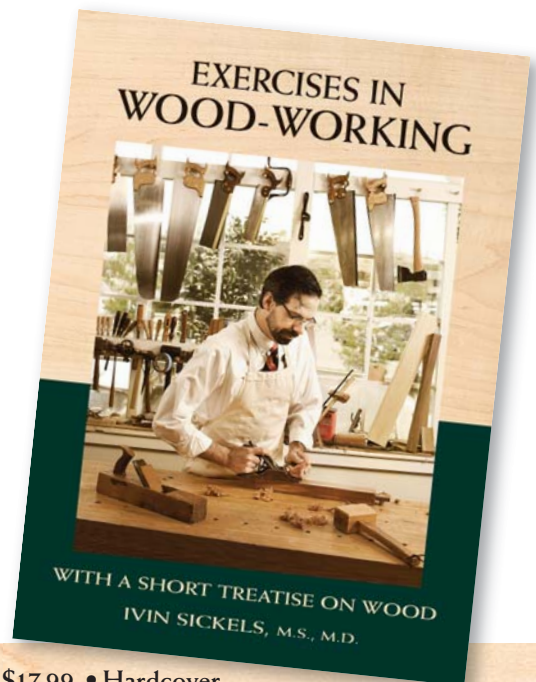

WITH A SHORT TREATISE ON WOOD
IVIN SICKELS, M.S., M.D.

\$17.99 • Hardcover
ISBN 978-1-4403-0926-7 • #Y0639

PRINTED AND BOUND IN THE UNITED STATES

WATCH & LEARN!

Editor Christopher Schwarz has recorded eight companion videos for the exercises – they’re available as single-lesson digital downloads, or as a compilation DVD.

For more information, visit WoodworkersBookShop.com and search for “Exercises in Woodworking.”



Order ‘Exercises in Woodworking’ now
at WoodworkersBookShop.com
or call 1-800-258-0929.

Everything You Need to Finish Your Projects *Like a Pro*

Flexner on FINISHING

Finally. Answers to Your Wood Finishing Fears and Frustrations



Bob Flexner
Best-Selling Author of *Understanding Wood Finishing*

\$24.99 • Hardcover
ISBN 978-1-4403-0887-1 • #Y0006

No more mystery.

No more marketing hype.

Just the straight dope.

Take control of finishing by learning how to use the many finishes available – and what those products actually are. In this book, his first since *Understanding Wood Finishing*, Bob Flexner delves deeper into many of the issues woodworkers struggle with and he does it with an authority that leaves no doubt. Inside, you'll discover the truth about:

- ▶ Wood Preparation
- ▶ Choosing a Finish
- ▶ Coloring Wood
- ▶ Brushing & Spraying
- ▶ Overcoming Finish Problems
- ▶ Finishing Myths
- ▶ Repairing Finishes
- ▶ And So Much More!

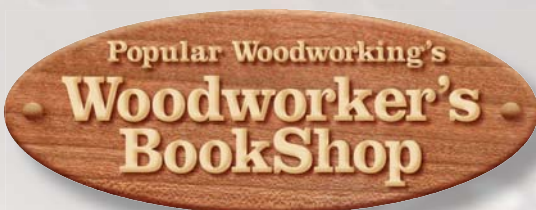

Order 'Flexner on Finishing' Now
at WoodworkersBookShop.Com

(or call 1-800-258-0929)

or look for it and other Popular Woodworking books
at your local retailer.

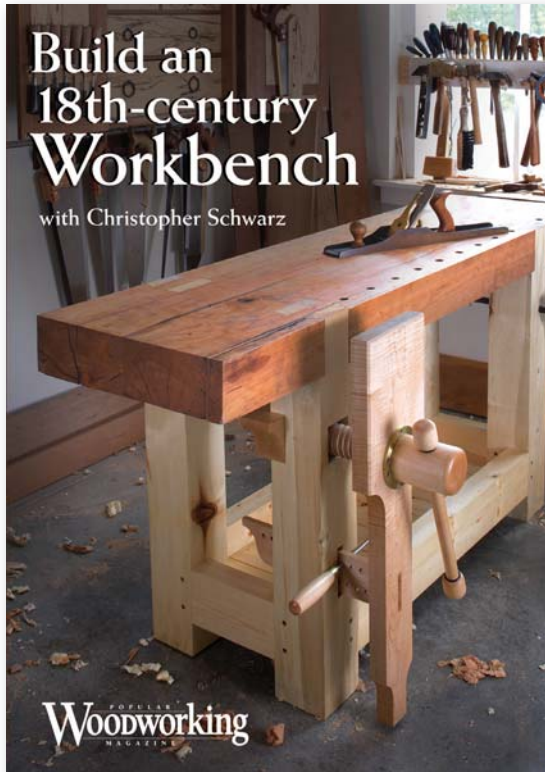

\$24.99 • DVD
 ISBN 978-1-4403-0928-1 • #Y0655

The Workbench of Your Dreams

- More than 35 minutes of step-by-step video instruction
- Complete & detailed plans
- Tips on cutting the joints by hand
- How to build a bench if you don't have a bench
- Flatten the workbench's top
- Tons of digital extras

One of the most important workbench plans ever published appeared in A.J. Roubo's 18th-century masterwork "L'Art Du Menuisier" (The Art of the Craftsman). Roubo's simple and hulking workbench offers everything that the modern woodworker needs in a bench, whether you use hand tools, power tools or both.

Roubo's bench is simpler than almost every other design out there – so it's easy to build – yet it excels at all of the workholding tasks in a woodshop.

In this DVD, *Popular Woodworking Magazine* Editor Christopher Schwarz shows you how to build the Roubo using only hand tools (though you can use power tools if you wish).

Order the "Build an 18th-century Workbench" DVD now at WoodworkersBookShop.com or call 1-800-258-0929

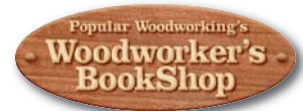

Go to School Without Ever Leaving Home



Our "ShopClass" series offers video woodworking instruction through instant downloads (ShopClass On Demand) to your computer – or get it on CD/DVD.



Go to ShopClass now by visiting WoodworkersBookShop.com and click on "SHOPCLASS SERIES" in the left-hand navigation bar.

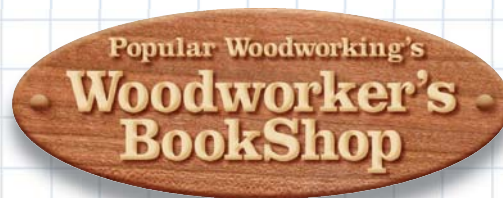

Check back often – we're adding new classes!

WOODWORKER'S MARKETPLACE

CraftsmanStudio.com
Fine Tools - Fair Prices - Fast Shipping

Bring Quality to your project with our Tools and Supplies

Authorized Lie-Nielsen and Shapton Dealers



*Free Shipping over \$75.00

2737 Via Orange Way • Ste 110 • Spring Valley, CA 888-500-9093

For more information, go to PWFREEINFO.COM.

Turn logs into lumber.

dream to the

8 models to choose from

Live life to the **MAX.**

Wood-Mizer 1.800.553.0182
www.woodmizer.com

© Copyright 2010, Wood-Mizer Products, Inc.

For more information, go to PWFREEINFO.COM.

Hands on Instruction for All Skill Levels

Mario Rodriguez - Alan Turner

Philadelphia Furniture Workshop

For more info on Courses: 215.849.5174

PhiladelphiaFurnitureWorkshop.com

superbrightleds.com

Light up your finished projects



Easy Integration - Long Life - Low Power Draw

All LED Products Available for Purchase Online

St. Louis, Missouri - USA 10% Off Promo Code - W910M superbrightleds.com

For more information, go to PWFREEINFO.COM.

Looking for wood?

VISIT **woodfinder**



It's fast, easy and FREE!

www.woodfinder.com

No computer? Call toll-free 1-877-933-4637

HARDWOOD LUMBER

Burls
Blocks
Veneers
Decking
Flooring
Plywood
Millwork
Mouldings

MORE THAN 100 SPECIES!

M.M.L. CONDON COMPANY Inc.

Call for a FAST, FREE QUOTE

250 Ferris Avenue, White Plains, NY 10603
Phone: (914) 946-4111 • Fax: (914) 946-3779
www.condonlumber.net

ASK FOR FREE CATALOG!

For more information, go to PWFREEINFO.COM.

BEST DOVETAILS

It's the truth.

Order your Keller Dovetail System now!
(800) 995-2456

Made in the USA since 1976 • DVD/Video \$8.95 + \$2 p/h

www.bestdovetails.com

For more information, go to PWFREEINFO.COM.

Lumber • Veneer • Turning Stock

Your Source for Wood



WOODWORKERS Source

www.101woods.com

800.423.2450

VISA MasterCard American Express Discover

For more information, go to PWFREEINFO.COM.

CRAFTSMAN PLANS

Authentic
Reproduction
PLANS
BOOKS
HARDWARE



Measured & Drawn by Robert W. Lang
author of
"Shop Drawings for Craftsman Furniture"

www.craftsmanplans.com

Mortise Pal™

PRECISION MORTISING JIG

WWW.MORTISEPAL.COM
TEL: 619-459-7951
4580 ALVARADO CANYON RD., STE. E, SAN DIEGO, CA 92120

For more information, go to PWFREEINFO.COM.

Raises the art of pen turning to a new level

The Beautiful PEN

WIZARD

THE BEALL TOOL CO.

541 Swans Road N.E. Newark Ohio Dept. PW
1-800-331-4718 www.bealltool.com

For more information, go to PWFREEINFO.COM.

Wood-Mizer

RAZOR TIP

STELLITE® BANDSAW BLADES

Stellite® tip technology for sawing tough wood

- Kiln Dried
- Exotic Species
- Resawing

Wood-Mizer Blades

Innovation. Precision. Performance.

1.800.522.5760

www.woodmizerblades.com

For more information, go to PWFREEINFO.COM.

Popular Woodworking's

Woodworker's BookShop

Visit Popular Woodworking Magazine's WoodworkersBookShop.com

EVERYDAY LOW PRICES

on woodworking books, DVDs, plans, videos and more!

WOODWORKER'S MARKETPLACE

CLASSIFIED

Books

WE HAVE A WIDE VARIETY of woodworking books – from small projects, to home improvement, to enhancing your woodworking skills, and more! To see our full line of books, please visit our web site at WoodworkersBookShop.com!

Finishing Supplies & Equipment

FINISHINGSUPPLY.COM - Shellac.net Large Shellac Flake Selection - Brushes - Dyes BEHLEN Finishing Supplies - Stains - Aerosols RENAISSANCE Wax.

SPRAY-ON SUEDE Line boxes easily. Free brochure with sample. DonJer, 13142 Murphy Road, Winnebago, IL 61088; 800-336-6537; www.donjer.com.

BLOXYGEN SAVES LEFTOVER FINISHES - Just Spray, Seal and Store. www.bloxygen.com or (805) 542-9219.

Hand Tools

DI LEGNO WOODSHOP SUPPLY Quality woodworking hand tools at an affordable price. www.dlws.com or 1-877-208-4298.

DOVETAILED INFILL HANDPLANES. Unique Norris style adjuster. Boxwood, ebony, rosewood. 30 years as planemaker. (541) 726-4084 or paintingease1@gmail.com

Power Tools

FEIN TOOLS YOU'RE JUST ONE CLICK AWAY from the Fein Tools that you can't do without - MultiMaster Tools - Sanders - Grinder - Vacuums and more, plus all Accessories and Parts. <http://www.waltertool.com> or 800-356-6926.

Schools/Instruction

FRED WILBUR teaches INTRODUCTION to traditional woodcarving September 20, 21, 22, and DECORATIVE woodcarving October 6, 7, 8. For 2011 schedule and information email fcwilbur@verizon.net or write to P.O. BOX 425, Lovingson, VA 22949.

JOHN C. CAMPBELL FOLK SCHOOL, Brasstown, NC. Courses for all skill levels. Weeklong and weekend classes year-round, taught by nationally known instructors. Friendly, supportive environment. Comfortable, on-campus housing. Delicious meals served three times a day. www.folkschool.org. 800/365-5724.

THE ACANTHUS WORKSHOP, LLC Traditional woodworking education with lead instructor, Charles Bender, using conventional hand tools and modern machinery. Call 610-970-5862 or visit www.acanthus.com.

THE SCHOOL AT ANNAPOLIS WOODWORKS, Davidsonville, MD. Turning, Carving, Furniture Making, etc. Weeklong and Weekend classes for all skill levels. www.annapoliswoodworks.com, 301-922-0649.

Seat Weaving Supplies

CHAIR CANE & SPLINT, Shaker tape, fiber & natural rush. Complete line of basketweaving supplies. Royalwood Ltd., 517-WW Woodville Rd, Mansfield, OH 44907. 800-526-1630. www.royalwoodltd.com.

Wood & Veneers

WWW.WALNUTWOODS.NET Black Walnut Burl Veneer, lumber, turning stock, gunstocks. Buckeye Burl slabs. Call 559-277-8456, Newton Woods, Fresno, CA

Classified rate is \$6.00 per word, 15-word minimum. Order must be accompanied by payment; ads are non-commissionable. Send to: Popular Woodworking Magazine, 4700 E. Galbraith Rd., Cincinnati, OH 45236 or Don Schroder, d.schroder@verizon.net. Phone: 610-821-4425, Fax: 610-821-7884.

ADVERTISER'S INDEX

	PAGE #	WEB ADDRESS
Acanthus Workshop	61	acanthus.com
Apollo Sprayers Int'l.	7	hvlp.com
Beall Tool Company	60	bealltool.com
Bloxygen	61	bloxygen.com
Craftsman Plans	60	craftsmanplans.com
Craftsman Studio	60	craftsmanstudio.com
Di Legno Woodshop Supply	61	dlws.com
DonJer Products	61	donjer.com
EBAC Industrial Products	17	ebacusa.com
Epilog Laser	11	epiloglaser.com
Forrest Mfg.	11	forrestblades.com
Franklin International	9	titebond.com
Fred Wilbur	61	frederickwilbur-woodcarver.com
Freud America	5	freudtools.com
Gorilla Glue	17	gorillaglue.com
Grizzly Industrial	C2, 1	grizzly.com
Hartville Tool	55	hartvilletool.com
Jet Tools	C3	jettools.com
John Campbell Folk School	61	folkschool.org
Keller & Company	60	kellerdovetail.com
Kutzall Tools	19	kutzalltools.com
Lie-Nielsen Toolworks	19	lie-nielsen.com
M.L. Condon	60	condonlumber.net
Mortise Pal	60	mortisepal.com
Newton Woods	61	walnutwoods.net

	PAGE #	WEB ADDRESS
Oneida Air Systems	19	oneida-air.com
Osborne Wood Products	55	osbornewood.com
Patrick Marooney Hand Planes	61	—
Philadelphia Furniture Workshop	60	philadelphiafurnitureworkshop.com
Popular Woodworking Books	57, 58	popularwoodworking.com
Stanley Tools	C4	stanleytools.com
RadarCarve	55	radarcarve.net
Rock Auto Parts	55	rockauto.com
Routerbits.com	55	routerbits.com
Royalwood Ltd.	61	royalwoodltd.com
School at Annapolis Woodworks	61	annapoliswoodworks.com
Shellac.net	61	shellac.net
Super Bright LEDs	60	superbrightleds.com
Tools for Working Wood	19	toolsforworkingwood.com
Wall Lumber	17	walllumber.com
Walter Tool	61	waltertool.com
Whitechapel Ltd.	55	whitechapel-ltd.com
Woodcraft	2, 19	woodcraft.com
Woodfinder	60	woodfinder.com
Woodline USA	13	woodline.com
Wood-Mizer	60	woodmizer.com
Woodworker's Hardware	11	wwhardware.com
Woodworker's Source	60	woodworkerssource.com
Woodworker's Supply	55	woodworker.com

GLOSSARY

Woodworking's lexicon can be overwhelming for beginners. The following is a list of terms used in this issue that may be unfamiliar to you.

acid brush (n)

An inexpensive brush with a rolled or pressed aluminum handle and stiff black bristles. Traditionally used for applying flux for plumbing joints, some woodworkers use it to apply glue, especially to the inside of mortises.

atomization (n)

In spray finishing, the reduction of a liquid to tiny particles or a fine spray, achieved by high-pressure or high-volume air breaking up the stream of liquid (paint, stain or finish) as it exits the tip of the spray gun.

cotter pin (n)

A metal fastener with a two-tined split pin, often found on traditional hardware such as pulls. The pin is inserted through a hole, then bent on the backside to secure the hardware to a drawer or door.

crest rail (n)

The top rail of a chair, settee or sofa; it is often curved, profiled and sometimes carved.

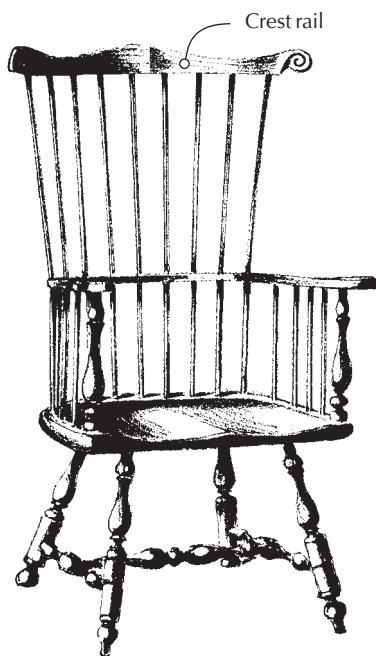

flitch (n)

In veneer manufacturing, a longitudinal section of a trunk or log that is sliced into thin sheets (leaves). A flitch (or set of leaves) is often sold as an ordered stack.

fruitwood (n)

A generic term used to describe any of various woods that come from trees that bear fruit, such as cherry, pear or apple. The term is also used to apply to a generic brown or reddish stain.

"The chief virtue that language can have is clearness, and nothing detracts from it so much as the use of unfamiliar words."

— Hippocrates (circa 460 BCE - c. 370 BCE)
ancient Greek physician

geta (n)

A Japanese term for dovetail-shaped hardwood shoes typically fit into rails on sliding doors to reduce wear.

grain (n)

Many woodworkers misuse this term. "Grain" refers to the natural arrangement of the wooden fibers in relation to the axis of the tree. Boards can have straight grain, interlocked grain or reversing grain, for example. When referring to how the growth rings appear on the face of a board, the proper word is "figure."

plow plane (n)

A handplane with a fence (usually adjustable) used to cut grooves, to create tongues on the ends of boards and to waste away areas to make way for moulding planes.

rotary-cut veneer (n)

A common method for cutting veneer, usually for low-grade construction plywoods. The log is spun in front of a knife, removing a continuous ribbon of veneer — much like unrolling toilet paper. The figure of rotary-cut wood is distinct and unnatural to most woodworkers.

sizing (or size) (n)

A substance used to partially seal a surface and protect it from changes due to

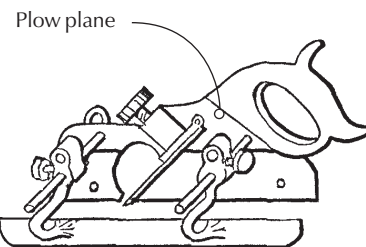

moisture absorption. In veneer, leaves are sized to flatten them. Glue sizing refers to a thin coat of diluted glue that seals the surface of the wood.

tansu (n)

The Japanese word for a chest, chest of drawers or cupboard. In the West, the term is often used to describe a modular chest with a stepped shape.

wheelwright (n)

The traditional term for a person who builds and repairs wheels.

wetting (n)

The ability of a liquid (in woodworking — glue) to stay in contact with a solid (wood). The wetting property of a glue can help determine the dispersion of the adhesive and the ultimate strength of the glue bond. Proper wetting of your joints with adhesive is key for a good bond.

white glue (n)

A solvent-based adhesive that creates a bond as it dries. Unlike yellow glues (which are polyvinyl adhesives), white glue dries clear. White glue also has a longer open time, which can be an advantage when dealing with complex assemblies. However, it requires more time in clamps and is (according to some reports) slightly less resistant to moisture than yellow glue. **PWM**

Go Online FOR MORE ...

You'll find links to all these online extras at:

► popularwoodworking.com/oct10

BLOG: "How I Use a Plow Plane," by Christopher Schwarz.

IN OUR STORE: Our new reprint of the 1889 book "Exercises in Wood-working."

Popular Woodworking's Woodworker's BookShop

WHAT'S NEW in the BOOKSHOP

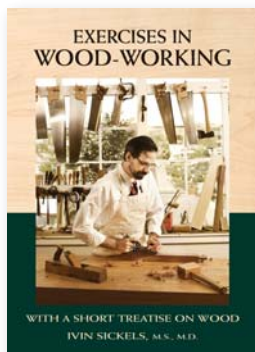

'Exercises in Wood-working'

First printed in 1889, this book was written to educate college students in the craft and business of woodworking. Here, the original text is reprinted in its entirety, not only to help you discover late 19th-century practices in woodworking, but to help you make the most of traditional hand tools in the modern shop.

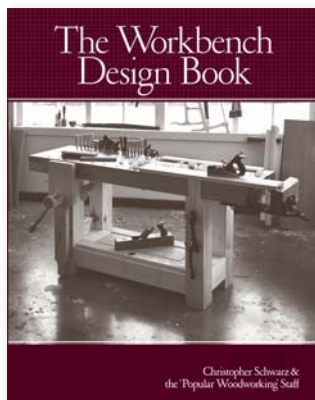

'The Workbench Design Book'

This new book picks up where Christopher Schwarz's first workbench book left off. You'll find plans for nine additional benches as well as critiques of many common bench styles available today. Armed with the 256 pages of knowledge inside, you'll know how to build your perfect bench – or modify an existing one.

Editor's TOP PICK

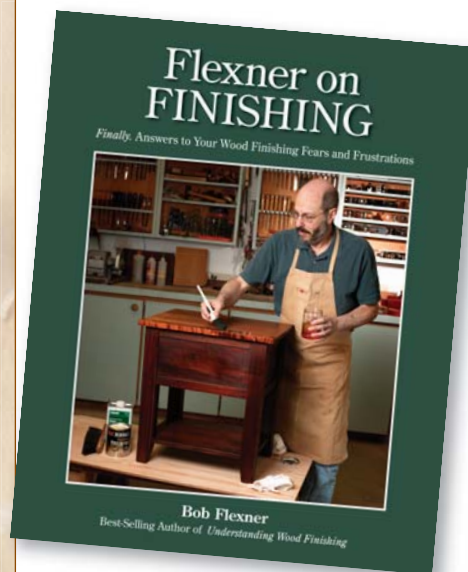

'Flexner on Finishing'

After five years of editing Bob Flexner's columns (and five years of working in our shop), I thought I knew a little something about finishing. Turns out I was right – I knew a (very) little. But I recently edited "Flexner on Finishing," which is a revised and updated collection of all the columns Bob has written for *Popular Woodworking Magazine* (and some additional articles). I'm humbled by how much I hadn't known. What I like best about this book is that you can dip in just about anywhere and learn something interesting and useful – and when read as a whole, the way various finishes and techniques work together really sinks in. Oh – and there's a bonus chapter on furniture repair ... which means I'm now out of excuses for avoiding the veneer repair on my Edwardian sideboard. Thanks a lot, Bob.

Megan Fitzpatrick

SHOP CLASS

Go to Woodworking School Without Leaving Home

Get top-notch video instruction on a wide variety of woodworking topics with our ShopClass videos (available as digital downloads and on disc).

- Learn SketchUp, an invaluable 3-D modeling program, with "SketchUp for Woodworkers."
- Get an excellent finish every time with "The 10 Commandments of Finishing."
- And more!



Get the Most Out of Woodworking!

Join the Woodworker's BookShop VIP program today! Your one-year paid membership includes:

- A one-year/7-issue subscription to *Popular Woodworking Magazine*.
- *Popular Woodworking's* 2004-2008 Compilation CD, with 35 issues on one CD.
- Member-only savings that let you save more on every order from the Woodworker's BookShop.

Why Shop at the Woodworker's BookShop?

- ▶ Savings Up To 60% Off Retail Price
- ▶ The Best Project Downloads
- ▶ Books, DVDs, CDs
- ▶ Printed Project Plans
- ▶ Shop Class – Online Classes
- ▶ FREE USPS Shipping in the Shop when you spend \$25! Just enter offer code PW10 at checkout! (Some exclusions apply.)

These products and more at WoodworkersBookShop.com

BY JOE ASNAULT

Chainsaw Massacre

Premeditated cedar slaughter satisfies.

I made the decision to murder with a tinge of remorse because I have heard more than a billion times during the last few years that we need trees to help stem global warming. But the beauty of the 75' of dead straight Western red cedar towered over me. I pulled the starter cord of my 24" bar chain saw and I cut the wedge, committed now, adrenaline pumping. I began the hinge cut, slipped in a plastic wedge for safety and murdered the tree. It screeched just before it hit the forest duff, then lay still. I didn't see a dead body. I saw dollar signs, and my guilt wafted away with the sweet smell of the 50-to-1 gas mixture.

The tree was alive, and didn't need to die – but I needed cedar lumber for the interior siding of my mountain cabin. Go ahead. Call me a killer. But now I'm a killer with some killer 6' lengths of primo cedar – and now this woodworking project won't kill my pocketbook. At first, that's how I saw it – as a way to save some cash. I realized a different motive later.

My buddy Bill used his tractor to dump the last 6' section of the tree, about 20" in diameter, into my milling area. The Granberg MKIII Alaskan Chain Saw Lumber Mill shone dully, reeking of pine and pitch from a previous killing, on the tailgate of my truck, and the milling commenced.

In all my building and woodworking fantasies, never did I envision the raw butchering of a tree by hand. With two sharp ripping chains, a ton of bar oil and gas, I commenced the slaughter. The wood



bled sap and sawdust, and I smiled at the beauty of the cuts. I chose $\frac{3}{4}$ " for the slabs, and the tree yielded approximately 72 usable pieces.

The stacks of stickered pieces rested in peace under my cabin to air dry, then we planed them on site to $\frac{1}{2}$ " thick, ripped them to 4" widths and chamfered the edges on the router table – 7,000-watt generator blaring, table saw buzzing, router screaming, planer piercing. Even the sweet smell of the pieces seemed to justify the killing. I couldn't wait to show my trophies to family and friends.

The tree spikers would damn me for my maliciousness and greed. Yet no huge piece of machinery had to blaze through a forest to drop this cedar beast. No diesel behemoths had to transport the meat to a mill, where endless kilowatts would be used. No mass-transportation system was needed to drive the carcasses to sale. No sap like myself ended up paying \$3 to \$4 per foot for it. Instead, I've used a bit of gas, a touch of oil and a cord of gumption.

Five months prior, eyeing the brand-new gleaming chain saw mill on the tailgate of my truck, my poker buddy asked, "Why don't you just buy your lumber at

Home Depot?" I couldn't answer him then, but I can now.

All woodworkers, professional or avid, know there is something personal about the process of the creation of something beautiful. Every time I walk into my cabin and see the walls lined with the cedar I painstakingly milled, I don't see dollar signs; I see beauty – soul-satisfying beauty – and I grin.

I walk my 2.5 acres in the forest searching for other victims to slake my need to create. A deck. A table for my parents' retirement present. A podium to use for my day job. And it will feel good to commit another murder. **PWM**

Joe is a freelance writer and avid woodworker who lives in Northern California. He and his woodworking mentor, John Shern, have built everything from rabbit hutches to poker tables.

Go Online FOR MORE ...

You'll find links to all these online extras at:

► popularwoodworking.com/oct10

ARTICLE: Read "Lusting for Lumber."

VIDEO: Is a chainsaw too delicate for you? Try black powder.

FINEST FINISH.

Introducing the NEW JET®
22-44 Oscillating Drum Sander featuring:



The ALL-NEW JET® 22-44 ODH™ Oscillating Drum Sander is designed for the professional woodworker and features a Drum Head that oscillates from left to right to eliminate workpiece streaking left by linear drum sanders >> Exclusive SandSmart™ Infinite Variable-Feed Control monitors the workpiece feed at rates from 0 to 10 feet per minute to produce the ultimate finish >> Patented Conveyor Belt TRACKERS™ dramatically reduce the need for manual adjustments >> **Visit your local quality JET dealer for more information.**



Also Featuring:



Infinite Variable-Feed Control
for the Ultimate Finish

www.jettools.com

QUALITY | INNOVATION | SERVICE

THEY'RE BACK



NO. 4
SMOOTHING PLANE



NO. 62
LOW ANGLE JACK PLANE



NO. 9-1/2
BLOCK PLANE



NO. 60-1/2
LOW ANGLE BLOCK PLANE



NO. 92
SHOULDER / CHISEL PLANE

Stanley® Revisits A Cherished Era of Quality and Craftsmanship.

Introducing the new line of Stanley® premium hand planes. Their mechanical precision, simple adjustment features, and top-quality materials are once again worthy of the famous Sweetheart™ logo ... a distinction that professionals and serious woodworkers recognize as a coveted symbol of quality. Not only do these hand planes maintain a tradition of quality and craftsmanship, they also offer a Sweetheart™ price as well.

Visit a participating Stanley® dealer near you to own yours today.



STANLEY®

stanleytools.com