

# Woodworking made easy by Skil



3"x18" Belt Sander  
7313

12 Volt Variable  
Speed Cordless  
Drill/Driver  
2468-02



3/8" Corded  
Drill  
6230-01



Corded Jigsaw Kit  
with Orbital  
Cut Control  
4380-02



10" Table Saw  
3400-10

## SKIL®

For more information about  
Skil products and to find a  
retailer near you, visit

[www.skil.com](http://www.skil.com)

2 610 907 387

from the editors of **WOOD** magazine

# Router Basics & beyond



What you  
can do with  
a router

How to  
choose and  
buy bits

Router  
cuts and  
fine joinery

Jigs that  
make routers  
do more

# table of contents

- 3** Think safety, work safely  
Use these tips to keep this valuable tool working for you.
- 4** The router—  
an essential power tool  
Meet the number one woodworking invention of the 20th century.
- 6** Router bit selection  
With each bit your router can perform a whole new task. Get a sampling of the more common bits inside.
- 16** Basic router operations and techniques  
Learn how to teach your router new tricks.
- 24** Router jigs and tips  
These jigs and fixtures make a router work harder and with more precision.

Editor-in-Chief **BILL KRIER**  
Executive Editor **JIM HARROLD**  
Managing Editor **MARLEN KEMMET**

Publisher  
**MARK HAGEN**  
Group Publisher  
**STEPHEN B. LEVINSON**  
Vice President/Publishing Director  
**WILLIAM R. REED**

**MEREDITH PUBLISHING GROUP**  
President  
**STEPHEN M. LACY**  
Magazine Group President  
**JERRY KAPLAN**  
Group Sales **MICHAEL BROWNSTEIN**  
Creative Services **ELLEN DELATHOUDER**  
Business Development **TINA GEORGEUD**  
Manufacturing **BRUCE HESTON**  
Consumer Marketing **KARLA JEFFRIES**  
Finance and Administration  
**MAX RUNCIMAN**

**Meredith**  
CORPORATION  
**WILLIAM T. KERR**  
President and Chief Executive Officer  
**E.T. MEREDITH III**  
Chairman of the Executive Committee

#### CUSTOMER SERVICE

800/374-9663  
Call this number for questions  
for our editorial staff.

#### EDITORIAL MAILING ADDRESS

*Router Basics—and Beyond*  
*WOOD® Magazine*  
1716 Locust Street, GA310  
Des Moines, IA 50309-3023

Trademark registered in Canada and  
Australia. Marca Registrada en Mexico.  
© Copyright Meredith Corporation 2001  
All rights reserved. Printed in the U.S.A.

Visit *WOOD® Magazine's* website:  
[www.woodmagazine.com](http://www.woodmagazine.com)

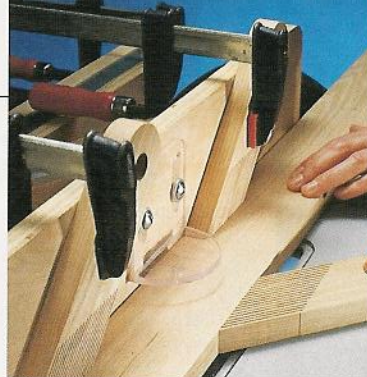
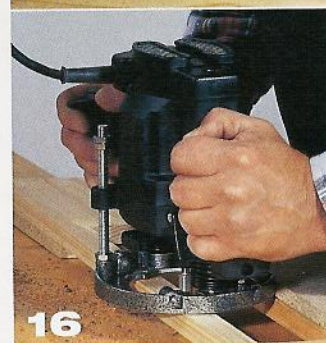
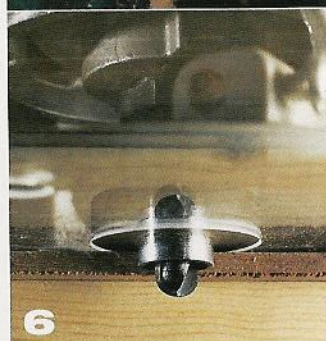
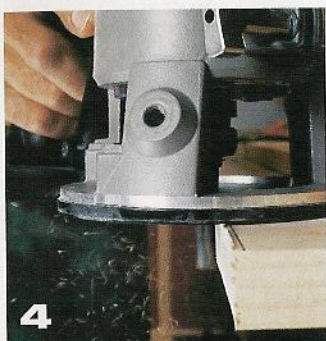

This safe router table has a strong stand, a stable fence, plenty of holddowns and featherboards, dust collection capability, and a see-through bit guard.

## think safety work safely

All woodworking tools have danger zones—areas around the cutting edges where you should never place your hands or anything else. On routers, the danger zone surrounds the spinning bit. It's easy enough to define that zone on a router table. However, with a handheld router, the danger zone becomes elusive, moving as the router moves.

#### Your shop: where and how you work

The oft-maligned governmental agency, OSHA, has done a lot of work identifying safety hazards in industrial workplaces. It would be wise to take a cue from their findings because your own workshop probably differs only in size, not in the number of possible hazards for you. Take a good look at your woodworking procedures, and check for things that can affect your work and safety.

**Your shop: Keep it clean, organized, well lighted, and adequately ventilated.** Clear the floor of obstructions and store all tools. Make certain electrical fixtures and outlets are properly protected. Store finishing products correctly, and dispose of rags and leftover materials promptly.

**Your tools: Keep all tools clean, sharp, properly maintained, and adjusted.** Make certain you know how to operate every tool and machine safely before using it. Know where the critical danger zones are for each tool. Keep all safety guards in place, and have plenty of finger-saving devices, such as featherboards, push paddles, and push sticks, on hand.

**Your gear: Wear the correct safety glasses, face shield, or goggles; ear muffs; dust masks; and chemical respirators, when appropriate.** Avoid wearing loose-fitting clothing, gloves, jewelry or dangling objects (even long hair) that may catch in rotating machinery parts.

#### Protect your hearing

Wear hearing protection, even for short periods of router use. Here's why: Studies show that a 105 dBA noise level results in some hearing loss after only one-hour exposure. Routers typically produce from 105-110 dBA, and get worse when a bit starts to dull. This level of noise can permanently damage your hearing.

Use hearing protection gear with enough noise-reduction rating (NRR) to lower the router's loud scream to a safe plateau—at least 20 NRR to reduce the sound to a more acceptable 90 dBA. Hearing protection items have their NRR printed on the packaging.

#### Protect your breathing

Wood dust, a byproduct of woodworking, is made up of individual wood particles of varying size. The small particles that waft through our shop's air for long periods of time present the greatest health hazard. Particles 10 microns and smaller can be inhaled into the lungs and lodge there. (We cannot see particles less than 100 microns in size.) Inhaled dust particles can irritate and damage lung tissue, which can lead to permanent loss of lung function and breathing capacity. Dust can also restrict oxygen absorption; and if it contains toxins or sensitizers, it can lead to allergies, shortness of breath, numbness, dizziness, and asthma problems.

OSHA guidelines call for no more than an average of 5 milligrams of dust particles 10 microns or smaller per cubic meter of air over an 8-hour period. In a small shop, this amounts to a maximum of 700 to 800 milligrams (about a half-teaspoon) of wood dust over an 8-hour period.

For your protection, wear a suitable disposable dust mask or respirator as a minimum when routing. Also, collect the dust with a vacuum or dust collector.

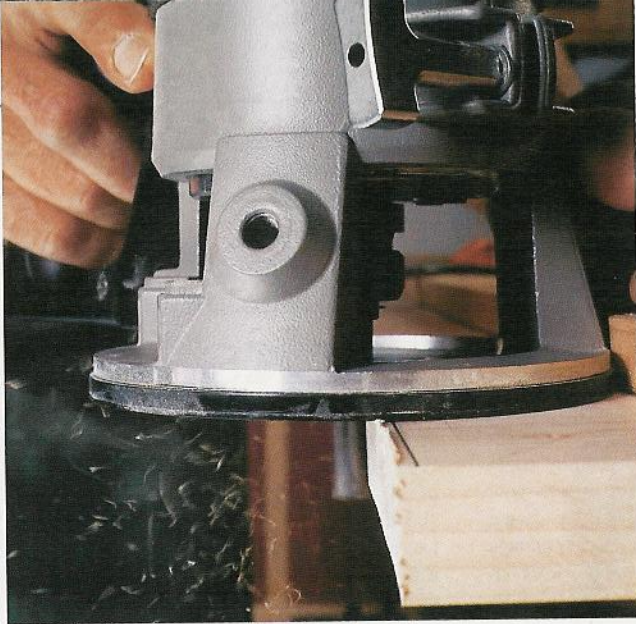

A router, spiral bit, and a clamped-on straightedge make cutting clean, smooth edges on a workpiece like this fast and easy. It's one of many basic cuts this tool can make.

Whether you're making signs or cutting boards, the shop-built pin-router jig and template, shown at right, opens up a whole new world of routing capabilities.



## the ROUTER—an essential power tool

**W**hirling at speeds of 24,000 revolutions per minute, and able to slice through hardwoods like a hot knife through butter, the portable router is one impressive tool. No wonder it has become one of the most useful and productive tools you can have in a wood-working shop. Some woodworkers consider it the number one shop tool invention of the 20th century.

The first commercially manufactured routers originally were introduced in the early 1900's. Surprisingly, their basic design hasn't changed much. Many of our current models, although they may look more trendy and carry a few more features, still work essentially the same way as their early counterparts. Only the plunge router, a rather recent development and introduction from Europe, shows any significant design evolution.

Pick up a modern router and you'll find the same three basic elements: a high-speed motor attached to a base, some type of height-adjusting mechanism to raise and lower the motor within the base, and a special chuck or collet fitted to the

motor shaft to hold the cutting bits. And the router bits, although similar to the few very early offerings, now come in hundreds of styles, sizes, and shapes.

### A tool with many advantages

Routers perform two primary tasks in a woodshop. Cutting decorative edges along the edges of boards is by far the most common. Shaping the edge of a workpiece adds a decorative touch and transforms an unfinished-looking project into an attractive, eye-pleasing one faster than any other single thing you can do.

Although it might be a lesser known role, and more and more seasoned woodworkers find the router indispensable for cutting joints when assembling furniture projects and many small items.

The router's success as a woodworking tool also can be traced to a number of inherent advantages that it has over other tools. Its small size and unique design enable it to do jobs that no other tool can.

Its duplicating capability also allows you to do many jobs easier, faster, and safer than other tools.

You can't beat a router for portability either. Carry and use it almost anywhere and get accurate results without fail. Compare that with other cutting tools, such as a tablesaw or stationary shaper.

Also, because it's portable, it will work on virtually any size stock, eliminating workpiece-size restrictions and limitations common to many machines. And possibly most important, you'll find today's routers still modestly priced compared to many other machines of comparable capability or capacity. But, if you mount this normally handheld tool beneath a table, you'll find it transforms it into a still more versatile machine.

### Putting a router to work

Routers are pretty simple machines, but don't let this simplicity fool you—they can do literally hundreds of tasks. We've used them to straight-edge and surface boards; cut dados, rabbets, and grooves; work circles and curved surfaces; and edge them. Many woodworkers use them to make decorative moldings, form hinge mortises, shape delicate parts by follow-

ing templates and patterns, bore holes, and cut many different kinds of great-fitting joints. We'll show some of these uses later in this book.

Routers continue to be viable, expanding tools. Manufacturers continue to expand their lines, providing more power choices and features. Similarly, bit manufacturers have teams of engineers designing new and innovative bits to do more and more specialized shaping and cutting.

Both manufacturers and woodworkers keep coming up with new accessories to extend the tool's usefulness or make it safer. Information about new jigs and fixtures is being published in magazines at a rate never seen before.

Routers aren't exactly the sort of tool you take out of a box, plug in, and handle casually. As with many things, it takes a bit of practice to develop skills using the tool, a bit of knowledge to transform the tool's capabilities into practical applications, and experience to make the end results acceptable. To master this tool, become a student of it. We think you'll find it both fun and rewarding.

The business end of the tool

# routerbit selection

*A router bit accomplishes an incredible amount of work. Spinning at 24,000 rpm, a two-edged bit makes an unbelievable 930 cuts per second. No wonder a router slices through wood like a hot knife through butter.*

With several hundred choices, finding a router bit to fit your needs can be both challenging and rewarding.

**I**t happens before you know it—bit by bit the collection builds. Fortunately with a router, the more bits you have, the more jobs you can do with it.

Reading a router bit catalog can make you feel a lot like the proverbial child in a candy store. With hundreds of styles available, choosing the right one for size, shape, or material, can be overwhelming. A basic understanding of router bits and what they do may help you save some of your hard-earned cash and get you the best tool combinations possible.

## It starts with the design

Bits share certain design similarities. They have a continuous steel body and shank made from one piece of steel, and one or more cutting edges. The cutting

edges may be high-speed steel (HSS) or brazed tungsten carbide tips.

Today, more and more bits are being made on automatic lathes and computer-driven multi-axis grinding machines. These machines do a good job, and also enable the manufacturers to produce designs that were not possible to make just a few years ago. Some very complex bits continue to be made by investment casting. Their cutting edges will be either HSS or tungsten carbide.

Refer to the bit anatomy drawing on page 9 to identify those parts you may not be familiar with.

## Shank size—the first consideration

Routers can have either  $\frac{1}{4}$ " or  $\frac{1}{2}$ " collets, or both. A  $\frac{1}{4}$ " collet only accepts bits with  $\frac{1}{4}$ "-diameter shanks. A  $\frac{1}{2}$ " collet will accept bits with  $\frac{1}{2}$ "-diameter shanks and with adapters, also will accept  $\frac{1}{4}$ " and  $\frac{3}{8}$ " bits (not widely available). If you plan to use your router a lot and for numerous operations, it's nice to have one that accepts both shank sizes. However, a router with a specific shank size won't put much of a limit on what you can do because of the many types of bits available in both  $\frac{1}{4}$ " and  $\frac{1}{2}$ " shank sizes.

Although bits with  $\frac{1}{4}$ " shanks perform well, some experienced and professional woodworkers prefer  $\frac{1}{2}$ " shank bits because they're bigger, stiffer, and stronger, and better able to resist vibration, flexing, and breaking.

Consider shank length, too. Generally, pick the bit with the shortest shank that will do the job for you.



Most router bits are machined from bars of special hot-drawn steel on computer-controlled lathes. Each blank will go through eight to ten different steps on its way to becoming a finished bit.

**Caution:** The popularity of carbide-tipped bits has brought an influx of bits from many sources. Some users have experienced problems with foreign-made bits due to undersized shanks and low-quality metals. If you buy bits from an unknown source, check them closely.

## Bit dimensions you need to know

Router bits have several critical dimensions. Besides shank diameter and length, you need to know the cutter diameter, cut-

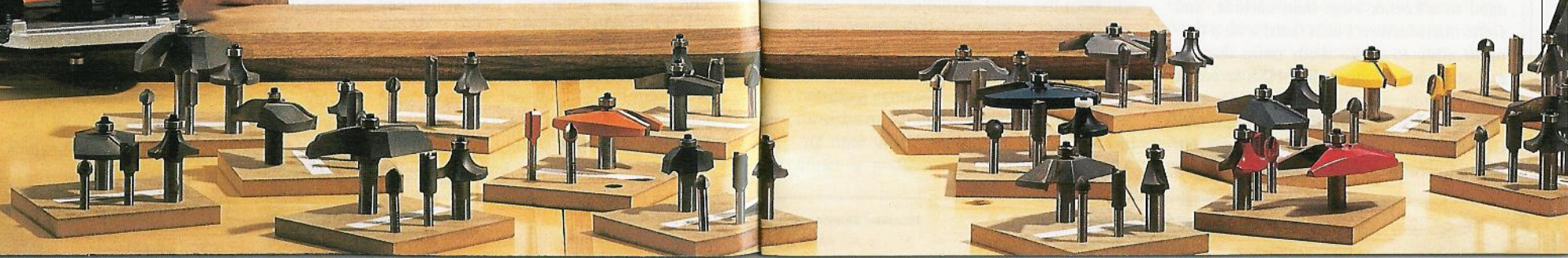
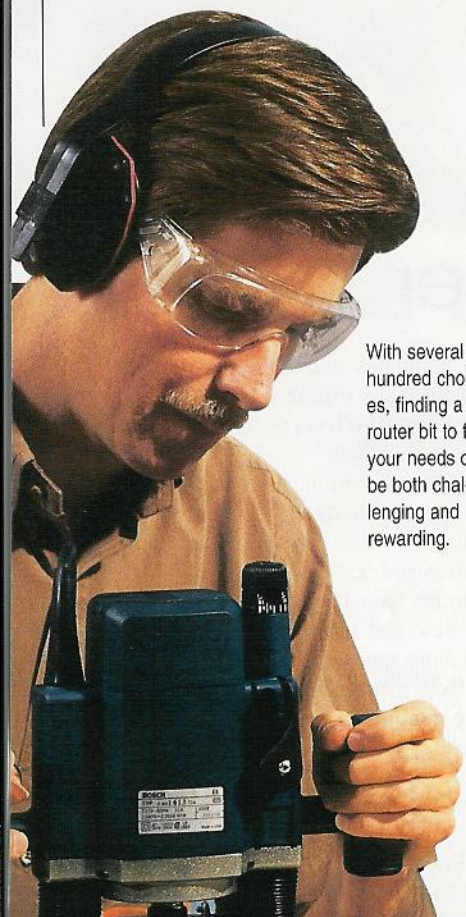

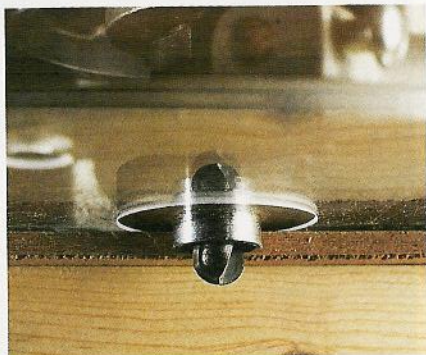

This handheld router equipped with a shop-made auxiliary base, template guide bushing, and core-box bit is ready to tackle a template-routing task. Note that the operator is using the outside edge of the template to set bit cutting depth.

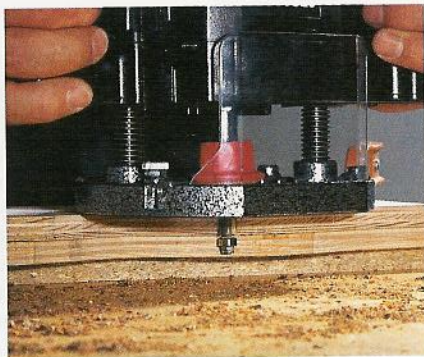

A bearing on this flush-trimming bit guides along the pattern edge, and cuts an identical edge on the piece above it. This setup is an excellent way to make finish-quality, duplicate workpieces quickly and without any additional work.

ter height (or length), cutter width, and overall bit length. On some, the cutter angle, radius, or bearing diameter also will be important. Profiles of bits and illustrations showing an exact image of the cut also help in visualizing what the final cut will look like. Note the position of these dimensions on the illustration.

### The cutting edge: carbide, or high-speed steel?

Most manufacturers now use tungsten carbide for the cutting edges. Carbide is an alloy of carbon and metal powders fused together, and harder than HSS. Carbide tips hold a cutting edge anywhere from 15 to 25 times longer. If you plan to work hardwoods or any of the man-made products like MDF or Corian, buy carbide-tipped bits.

HSS bits cost about one-half as much as good carbide bits. They can be sharpened to a keener edge than carbide, and some manufacturers coat them with a titanium alloy to make them more durable and stay sharp longer. But HSS is softer than carbide, and the cutting edges dull fast when working abrasive materials. Carbide bits, even though the edges are prone to chipping and nicking, stay sharp

longer, and can be sharpened many more times. You'll find the extra money for quality carbide bits well spent.

### To pilot a bit or not

Unguided bits can be used for straight or contour cuts anywhere on a board, provided the router is guided by a straight-edge or template. Guided bits have a pilot or bearing that controls the router without the aid of a straightedge. They only can be used along the edge of a board.

Most edge-cutting bits use ball bearings, typically located at the end of the shank on edge-forming bits, to ride against the workpiece edge. To eliminate edge burn, the bearings turn at your feed rate on the outside, but spin at router speed on the inside. You must put enough pressure on the router to hold the bearing against the workpiece. Otherwise, it may spin along with the bit, and at this speed, will burn the wood anyway.

Changing the bearing diameter will alter the cutting width and profile of the bit, which in effect, gives you several bits in one. To change a bearing requires removing the socket-head cap screw located on the end of the shank with an Allen wrench.

Many woodworkers use changeable bearings on rabbeting bits and slot cutters to change the rabbet's width or the slot's depth. Fitting a roundover bit with a smaller bearing converts it into a beading bit. The profiles of certain classical bits can be altered in this way too. (See page 21 for more information on how changing bearing size varies the cutting depth of a rabbeting bit.)

On pattern-cutting bits, the bearing is located above the cutter. In use, the bearing follows along the edge of the pattern or template and the cutter duplicates the pattern's profile on the workpiece. You can buy bearing kits to convert certain non-piloted, edge cutting bits into pattern-cutting bits. Just slip the bearing and stop collar over the bit's shank, and tighten the set screw in the collar.

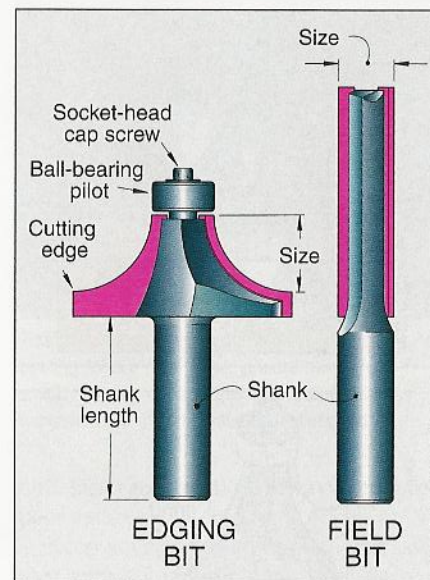

Bits have key components and dimensions that help identify them. Dimensions reference overall length; shank diameter and length; cutter length and width or diameter; and, on some bits, the cutter's angle or radius and bearing diameter.

### Bit quality—here's what to look for

Don't expect bits to be created equally—not even carbide bits. While carbide might be the all-around best, there will be differences—differences in carbide thickness, grades of carbide used, and how the bit's body supports the carbide. You can see some of the things that make up quality but not all of them.

For example, you can spot a skinny carbide tip that likely will disappear after just a couple of sharpenings. But when it comes to the grade of carbide used, you have no way of knowing what the manufacturer used. Very hard carbide maintains a sharp edge longer. But if it's too hard, the cutting edge may chip or nick more easily.

Carbide tips get brazed to the bit body during manufacturing. How well this is done depends on the welder's skill. Tips also should be fully supported by the bit body to minimize chances of the carbide breaking away. The steel body should be turned smooth and without pits or cracks.

Check the edge grind of the carbide tip under a good magnifying glass if you

have one—it should be glassy smooth. If you see or can feel grinding marks, the tips have not been finished properly and the bit should be rejected. Other design elements, such as the flute, rake angle, and clearance angle, belong in the domain of the design engineer. They are part of what makes a bit work—and why some work better for certain routing applications than others.

Bits also must be rounded and balanced. If not, they'll vibrate when spinning in the router. If you have a dial indicator or gauge, mount each new bit in the router collet and measure how much they deviate from a perfectly concentric orbit (runout). Any measurement less than .003" is acceptable.

### Anti-kickback design for safety

Anti-kickback bits provide an extra margin of safety. The design limits the depth

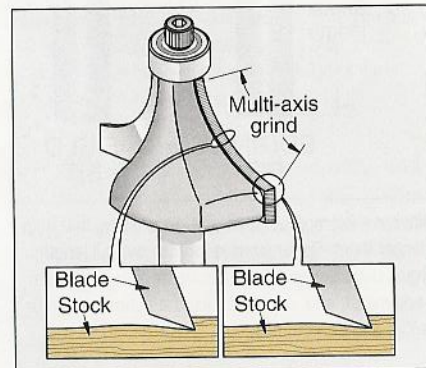
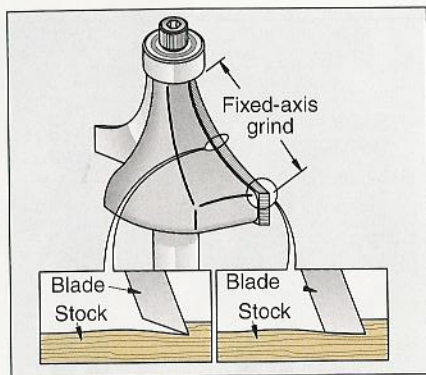

A fixed axis grind flattens the relief angle toward the top and bottom of the cove (top). A more costly multi-axis grind produces consistent relief angles, reducing the likelihood of burning the wood.

of cut at each pass to about  $\frac{1}{16}$ ". Limiting the bite is especially beneficial on large-diameter bits that take wide cuts because it lessens the risk of the bit grabbing a workpiece or throwing it. Their additional body mass also helps dissipate heat quicker, and it sometimes seems to make them run smoother.

#### How to spot a multi-axis grind

The distinction between a fixed-axis grind and a multi-axis grind, although subtle, can be very important when cutting certain stock. The drawings above show that the relief angle on a multi-grind bit stays consistent across the full length of the grind. This enables the bit to deliver a



Left: Anti-kickback bits have a body shaped to limit bite.

Below: A radial grind on the backside of the carbide leaves more mass behind the cutting edge to support the tip. It also prevents shrinkage in bit diameter when reshaping.

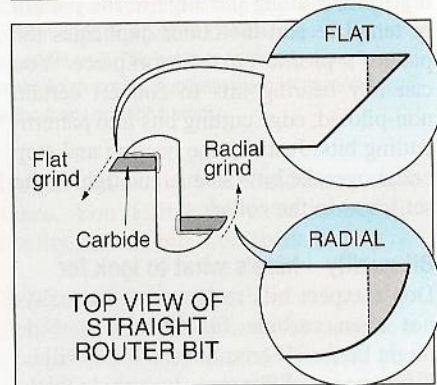

slightly better quality cut than the fixed-grind bit.

Differences between straight and shear flute cutters can be critical too. On a straight flute bit, the entire cutting edge contacts the work at the same time. By contrast, on a spiral flute, only a small portion of the cutting edge contacts the work at any time. This shearing action makes a smoother, finer cut finish with less power. Although this feature appears most evident on straight bits, you also can find spiral shear flutes on other high-quality bit profiles.

Spiral-cutting bits work fast and make clean cuts because they move chips out of the way quickly. Up-spiral bits work great for cutting mortises or cavities when the cut does not pass all the way through the workpiece. Down spirals work well when the bit cuts all the way through the piece.



Bit tip affects plunge cutting. The extra cutting tooth in the center of the bit at left helps smooth the bottom and clear chips although overall cut quality will be about the same for all three bits.



On core-box bits, look for a cleanly ground point on the bottom tip of the bit. Bits with steeper angles plunge easier, leaving a cleaner cut. On plunge cuts, bits must move chips fast to prevent burning.

When talking about router bit performance, there's a tendency to consider just the bit. However, the bit is only part of the total picture. The kind of material you are working, the depth and width of the cut, the condition of the bit, and the speed that you move the router along the work (or feed the work past the bit) also make considerable differences.

One of the worse things you can do to a router bit is to try and cut too much in one pass. Make it your rule to do multiple passes if you have to remove more than a  $\frac{1}{4}$ " square of material. Force feeding stresses the bit, makes it



This bit has a dust shield and a relief grind under the bearing. With a relief grind, you can switch to a smaller bearing and use this cutting surface. Less expensive bits may not have any relief grind.

dull faster, and almost always produces poor cuts.

Keep your bits clean of pitch and sawdust with a good pitch and gum cleaner. Lubricate the bearing frequently. If you have the skill, you may want to hone the cutting edges of HSS bits after use to maintain a sharp cutting edge as long as possible. But don't even try to sharpen carbide bits—leave that task to a skilled professional sharpener.

#### Ways to increase router bit life

Here's how to get more mileage (and longer life) from your router bits.

- 1 Never overload or abuse a bit. If the job calls for cutting away more than the equivalent of a  $\frac{1}{4}$ " square area, make multiple passes with light cuts. Consider a  $\frac{3}{8}$ " square as the upside limit for most cuts.
- 2 For lots of heavy duty routing, use  $\frac{1}{2}$ " shank bits if your router accepts them. They're stronger, stiffer, deflect less, and easier to regrind.
- 3 Use bits with the shortest cutting-edge and the largest cutting diameter that you have. When possible, select bits with high hook angles and large gullets for fast chip ejection—they will run cooler and stay sharp longer.

- 4 Use sharp bits. If you're burning wood, having to apply more than the usual feed force, or getting chattering while cutting, suspect a dull bit.
- 5 A router of 1½ hp. or more will cut at faster feed rate and at the same time won't heat up the bit as fast as a router with less power.
- 6 When mounting a bit, insert the shank into the collet and finger-tighten the lock nut. Twist the bit several turns to let it seat itself. Then, lock the bit with ¾" to ⅞" of the shank captured in the collet. Do not insert the shank all the way to the bottom of the collet.
- 7 Set router speed to spin the bit at its optimum rpm. Bits over 1" in diameter should be slowed to cut satisfactorily and not overheat.
- 8 Use a two-cutter system. Do most of the rough cutting with one bit, then make the final cut with a new or freshly ground bit with low mileage.
- 9 Look for uneven cuts caused by extensive wear on a portion of the bit. This defect could produce poorly fitted joints. Sharpen or replace the offending bit.
- 10 Buy the highest quality bits you can afford.
- 11 Clean and lightly oil bits after use. Sand the shanks smooth with emery cloth. Clean and check the collet frequently for wear. Lubricate the ball bearings after each use.
- 12 Store bits so cutting edges and bearings do not get damaged.

**Speed limits for bits, too**

Although routers rely on high speed for their performance, larger bits should turn at slower speeds in order to keep the tip speed at a reasonable level. For example, a ¾"-diameter bit spinning at 22,000 rpm has a nice mundane tip speed of 49 mph. By comparison, the tip speed on a 2½"-

diameter bit spinning at the same rpm will hit 164 mph. Some experts suggest that a 130 to 140 mph tip speed should be the maximum for optimum performance and operator safety.

**Suggested bit speeds for different diameters:**

Bit Diameter (inches)	Maximum Speed (rpm)
Up to 1"	up to 24,000
1 to 2½"	16,00 to 18,000
3"	12,000 to 14,500
3" or more	10,000 to 12,000

**Types of bits you'll want to buy**

Look at almost any furniture piece and you'll find examples of decorative treatments you can reproduce with your own router. Demand created by the popularity of portable routers has resulted in a nearly limitless variety of bits being made available. The bits pictured on the next two pages represent some of the basic styles that woodworkers find useful.

Edge-forming bits cut decorative profiles along the edge of the workpiece or cut one or both parts of an interlocking joint. Most have a pilot bearing on the end of the shank to ride along the edge of the workpiece to control cut width.

Field or surface-cutting bits have side and bottom cutting edges so they can cut into the surface of the workpiece and then be moved horizontally. They do not have a guide bearing so some type of guide—straightedge, edge guide, or template guide bushing—must be used to keep the router moving straight or accurate. The cuts may be decorative or functional.

Specialty bits, as the name implies, encompasses a large category of bits designed for unique routing tasks, either decorative or functional. The multi-profile bit, for example, has many different cutting edges. By changing its height in relation to the workpiece, you can cut an almost endless number of different profiles with it. A lock-miter bit, on the other

hand, cuts a specific miter profile that's ideal for joining workpieces.

If you plan to work with plywood, you need to know about plywood bits. Plywood often is manufactured undersized, or thinner than nominal size. Put ½" plywood into a ½" dado and you'll get a poor fit. To help, some router bit manufacturers make undersized bits (⅞", 2⅞", 1⅜", and 1½") to accommodate the thinner plywood.

**How to maximize your bit investment**

With your first router you won't need specific bits right off, but consider buying these for starters (sizes refer to the diameter of the bit's bite): ¼", ⅜", and ½" straight bits; ¼", ⅜", and ½" round-overs; ⅜", ⅝", and ½" cove; ¼" radius and ⅝" radius roman ogee; ¼" and ⅜" beading; and a ⅜" rabbeting bit with bearings.

To expand the list, add several spiral bits, a 45° chamfer bit, a 14°-½" dovetail bit, a ¼" round-nose bit, a ½" mortising bit, and a 90°-¼" V-grooving bit. This collection will enable you to make a wide variety of routing cuts.

Many companies offer sets of bits at substantial savings compared to what you'd pay if buying them individually. However, mentally subtract the bits you aren't likely to use and then calculate the costs of those remaining to determine if the set remains a good buy.

**routerbitsources**

Amana Tool Co. 800/445-0077	Freud USA, Inc. 800/472-7307	MLCS 800/533-9298
Bosch Power Tools 877/267-2499	Grizzly Intl. 800/523-4777	Porter-Cable 800/487-8665
CMT USA 888/268-2487	Jesada Tools 800/531-5559	Woodline Arizona, Inc. 800/472-6950
Eagle America 800/872-2511	Katana 800/533-9298	

the **truth** about sharpening **router bits**

Although everyone talks about sharpening router bits, woodworkers continually ask whether it really is practical or even possible to do so.

First, realize that router bits are an expendable item—they do wear and sometimes get damaged during use. Don't expect a bit to last forever. If it has given good service, but gone blunt, it may be best to simply replace it.

But that said, several manufacturers we contacted agreed that the life of some carbide tipped bits could be extended if the flat surfaces were properly honed after use. However, they caution, never attempt to hone the bevel. Bits must be perfectly balanced in order to spin at their high operating speed. The slightest difference in amount of material removed from one side of a bit than the other will unbalance the bit and create dangerous vibration.

Honing carbide requires diamond wetstones. Three progressive grits, coarse 325 grit, fine 600 grit, and extra fine 1200 grit are typically used. They can be used dry, or lubricated with water, or a light oil, such as WD-40. You place the flat surface of the tip on the stone, and slide it along the stone. If the bit has two or more tips, make the same number of equal-length strokes and with the same light pressure to each face to avoid unbalancing the bit. Also, as you move to the finer grits, reduce pressure so as not to dislodge the diamonds from the bonding surface.

If you have a bit that you can't restore by lapping the face, consider sending it to a sharpening service. Woodworkers report variable results from bits sharpened by commercial vendors, so there's no way to predict what kind of results you'll get. Considering the cost of the service and postage, it may be less expensive to replace the bit.

For HSS bits, lap the flat surfaces on fine-grit waterstones. Again, do the same amount of work to each surface to maintain balance.

## EDGING—routerbits

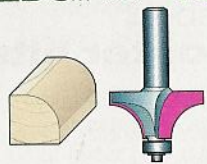

### ROUND-OVER

**Uses:** On tables, shelves, stair treads, and other projects. Making dowels, relieving sharp edges.  
**Sizes:** Cutting radius  $\frac{1}{8}$ – $\frac{3}{4}$ ".

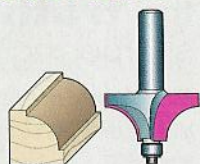

### BEADING

**Uses:** Decorative edges on drawer fronts, cabinets, furniture, molding, and trim.  
**Sizes:** Cutting radius  $\frac{1}{8}$ – $\frac{3}{4}$ ".

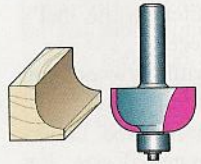

### COVE

**Uses:** Decorative edges on drawer fronts, cabinets, furniture, molding, and trim. Used in combination with roundover bit to make drop-leaf table edges.  
**Sizes:** Cutting radius  $\frac{1}{8}$ – $\frac{3}{4}$ ".

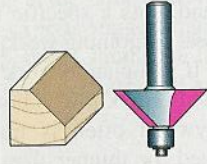

### CHAMFER

**Uses:** Beveled edges on boards or laminates. Staved box and bowl construction.  
**Sizes:** Cutting length  $\frac{1}{4}$ – $1\frac{1}{2}$ ". Bevels range from  $7^\circ$  to  $45^\circ$ .

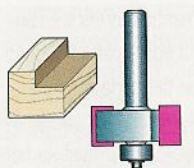

### RABBETING

**Uses:** Cutting rabbets and lap joints. Change bearing size to change rabbet width.  
**Sizes:** Cutting width  $\frac{1}{8}$ – $\frac{1}{2}$ ".

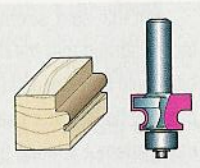

### EDGE-BEADING

**Uses:** Forming decorative beads on edges of picture frames, moldings, and wainscoting.  
**Sizes:** Bead diameter  $\frac{1}{8}$ – $\frac{3}{4}$ ".

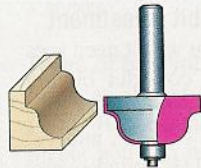

### OGEE

**Uses:** Decorative edges on furniture, shelving, and molding.  
**Sizes:** Cutting width  $\frac{5}{16}$ – $\frac{1}{2}$ ".

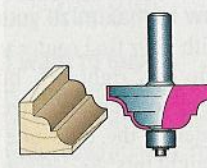

### CLASSICAL

**Uses:** Decorative edges on furniture, shelving, and molding.  
**Sizes:** Cutting width  $\frac{3}{8}$ – $\frac{1}{2}$ ".

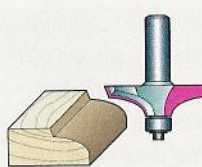

### THUMBNAIL

**Uses:** Edge accent for table-tops, cabinet tops, chair rails, and hand rails.  
**Sizes:** Cutting width  $\frac{7}{16}$ – $1$ ".

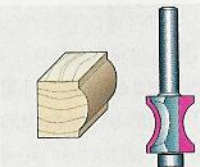

### BULL-NOSE, HALF RADIUS

**Uses:** Curved profiles for stair treads, shelving, and windowsills.  
**Sizes:** Cutting diameter  $\frac{3}{8}$ – $1\frac{1}{2}$ ".

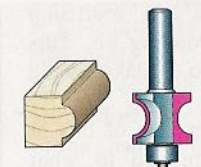

### BULL-NOSE, FULL RADIUS

**Uses:** Half-round profiles for stair treads, shelving, finger grips, and windowsills. Making dowels.  
**Sizes:** Cutting diameter  $\frac{3}{16}$ – $1\frac{1}{2}$ ".

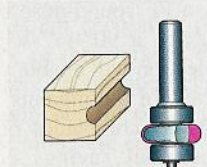

### FLUTING

**Uses:** Round or square column accents. Classical molding. Combines with matching bull-nose, full-radius to make self-aligning joints for canoes, hot tubs, and planters.  
**Sizes:** Cutting radius  $\frac{1}{8}$ – $\frac{3}{16}$ ".

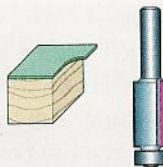

### FLUSH-TRIM

**Uses:** Straighten and clean up edges of stock, flush-trim laminates, cutting around bottom-mounted templates, and edge molding.  
**Sizes:** Cutting diameter  $\frac{1}{4}$ – $\frac{3}{4}$ ".

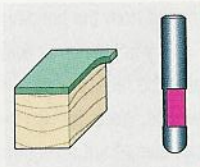

### FLUSH-TRIM LAMINATE

**Uses:** Produce flush, square, and clean corners on plastic laminates, edge banding, and veneers.  
**Sizes:** Cutting length  $\frac{1}{4}$ – $\frac{3}{8}$ ".

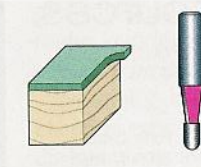

### SPIRAL-FLUTE

**Uses:** Dadoing, grooving, and mortising. Up-spiral clears chips from hole. Down-spiral leaves a clean top edge on grooves and dados in veneers and plywood.  
**Sizes:** Cutting diameter  $\frac{1}{8}$ – $\frac{3}{4}$ ".

## FIELD—routerbits

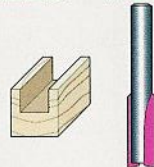

### STRAIGHT

**Uses:** Rabbeting, mortises, splines, dados, box joints, inlays joints.  
**Sizes:** Cutting diameter  $\frac{1}{8}$ – $1\frac{3}{4}$ ".

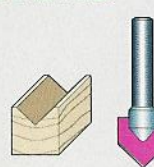

### V-GROOVE

**Uses:** Lettering, veining, sign making, chamfering, decorative accents.  
**Sizes:** Cutting diameter  $\frac{1}{8}$ – $1\frac{3}{4}$ ".

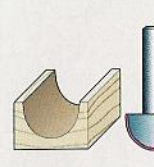

### ROUND-NOSE CORE BOX

**Uses:** Fluting, veining, sign making, drawer-front finger pulls, decorative accents.  
**Sizes:** Cutting diameter  $\frac{1}{8}$ – $2\frac{1}{4}$ ".

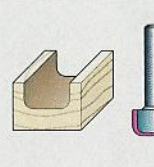

### BOWL-AND-TRAY

**Uses:** Forming flat bottoms with rounded edges in trays and shallow bowls.  
**Sizes:** Cutting diameter  $\frac{7}{16}$ – $1\frac{1}{4}$ ".

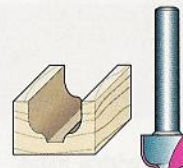

### OGEE PLUNGE

**Uses:** Decorative grooves, and edge molding with a straightedge or router table.  
**Sizes:** Cutting diameter  $\frac{3}{8}$ – $1\frac{1}{8}$ ".

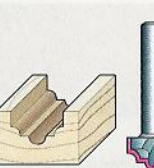

### COVE-AND-BEAD PLUNGE

**Uses:** Decorative grooves, edge cutting with a straight-edge or router table.  
**Sizes:** Cutting diameter  $\frac{1}{2}$ – $\frac{3}{4}$ ".

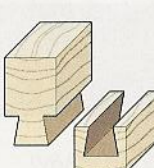

### DOVETAIL

**Uses:** Decorative joints for drawers and boxes, sliding-drawer guides, sliding-dovetail joints for shelves, and chamfering.  
**Sizes:** Cutting diameter  $\frac{1}{4}$ – $1\frac{1}{4}$ ", cutter angles  $7^\circ$ – $18^\circ$ .

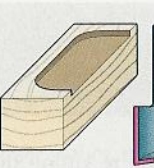

### HINGE-MORTISE

**Uses:** Cutting smooth-bottom, shallow mortises for hinges and hardware when used with template guide bushing. Also functions as a straight bit and flush-trim bit.  
**Sizes:** Cutting diameter  $\frac{5}{16}$ – $1\frac{1}{2}$ ".

## SPECIALTY—routerbits

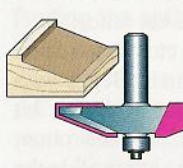

### RAISED PANEL

**Uses:** Cutting raised-panel profiles on cabinet- and passage-door panels. Use in a router table only. Requires special inserts in table to accept larger diameters.  
**Sizes:** Cutting width  $\frac{13}{16}$ – $1\frac{1}{2}$ ".

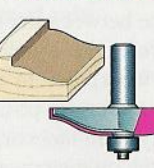

### RAISED-PANEL OGEE

**Uses:** Cutting raised-panel profiles on cabinet- and passage-door panels. Use in a router table only. Requires special inserts in table to accept larger diameters.  
**Sizes:** Cutting width  $\frac{13}{16}$ – $1\frac{1}{2}$ ".

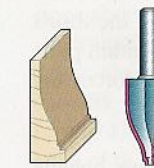

### VERTICAL RAISED-PANEL

**Uses:** Cutting raised-panel profiles on cabinet- and passage-door panels. Use in a router table with fence. Can be used without special table inserts.  
**Sizes:** Cutting width  $1$ – $1\frac{1}{8}$ ".

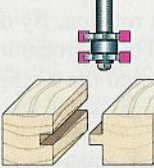

### TONGUE-AND-GROOVE

**Uses:** Cutting tongue-and-groove joints for wall paneling, flooring, and panel doors. Making stub mortise-and-tenon joints. Vary beading size to adjust tongue depth.  
**Sizes:** Most cut  $\frac{1}{4}$ " tongues and  $\frac{3}{8}$ " deep grooves.

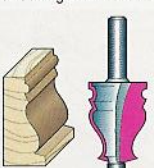

### ARCHITECTURAL MOLDING

**Uses:** Create wainscoting, chair rails, crown, and other architectural moldings. Dozens of profiles to choose from. Use with router table only.  
**Sizes:** Cutting height  $\frac{7}{8}$ – $1\frac{1}{4}$ ".

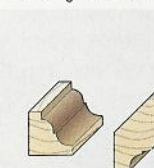

### MULTI-FORM

**Uses:** Cuts dozens of different shapes using different parts of the bit profile and making multiple cutting passes at different depths. Can also use a spacer on the workpiece where the bearing rides for more shapes.  
**Sizes:** Cutting height  $1$ – $1\frac{1}{8}$ ".

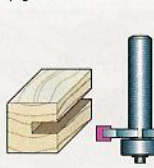

### SLOT CUTTER

**Uses:** Biscuit joinery, slots, lap joints, tongue and groove, and T-molding.  
**Sizes:** Cutting height  $\frac{1}{16}$ – $\frac{1}{4}$ ".



# basic router operations and techniques

Routers can perform a large number of tasks in any woodshop.

Joints like these decorative keys make great-looking corner reinforcements that you'd be proud to show off.

If you're sitting there thinking, "Boy, those joints sure are great-looking: I wish I could do that," get ready for a happy surprise. Armed with the right tools and jigs, you can produce equally impressive results, regardless of what kind of joint it might be.

Bits revolve so you must move the router in the direction that feeds the stock into its rotation. By doing this, the thrust created by the rotational momentum pulls the bit into the workpiece and forces the router against the straightedge.

**Handheld router:** When working outside edges, the bit turns clockwise as you look down, so feed the router in a *counterclockwise* or *left to right* direction. This also applies to round and curved parts.

When working inside edges with a hand-held router, feed the tool *clockwise* or *right to left*.

**Table-mounted router:** The bit rotates counterclockwise, so feed the workpiece from *right to left* along the fence with the workpiece in front of the bit and fence. For safety reasons, never feed a workpiece between the bit and the fence.

To make a handheld cut, first secure the workpiece to the bench. Begin with the router in position but with the bit away from the workpiece. Grip the router, switch on the power, then slowly slide the router until the bit contacts the work. Once you have full contact between the bit and workpiece, proceed to rout, using a smooth, steady feed.

To minimize splintering, make cuts across the grain first, then the cuts with the grain. If making cross-grain cuts only, back up the workpiece where the bit exits.

Feeding the stock away from the bit rotation, commonly referred to as climb cutting or back routing, should rarely be done for safety reasons.

## Finding the optimum feed rate

Feed rate, not to be mistaken as router bit speed, refers to the speed that you move the router along the workpiece or the workpiece along a spinning bit. The optimum feed rate will vary, depending on the kind of wood being worked, the router's power, the size and type of bit, and the depth and width of cut.

To learn the proper feed rate, listen to the router, watch the chips and sawdust, and check the finish on the workpiece. At the proper feed rate, the motor should sound like its working under some load but not bogging down. Look, too, for thin, uniform-sized shavings.

Forced feeding may be detected as the usual high-pitched sound changes to lower, slower sound. It may cause excessive wood splintering ahead of the bit or scalloped milling marks on the edge.

A high-pitch runaway motor sound probably means you're feeding the router

too slow. Fine sawdust rather than nice shavings also suggests slow feeding.

## Straightline cuts you can make with a handheld router

Router cuts that extend from one edge of the workpiece to the other are *through* cuts. A *stopped* cut extends from one edge but stops short of the other. A *blind* cut stops short of both edges.

**Straightline** cuts, such as grooves, dados, chamfers, rabbets, mortises, and cut-offs, require a device to guide the router. Use a guide to follow along one edge of the workpiece, or guide the router with a separate straightedge clamped to the workpiece. These aides can be used:

**Straightedges**, such as a straight piece of wood clamped in place, or a length of metal clamped across the workpiece so the edge of the router base can slide freely along it, will work. Typically you clamp the straightedge and the workpiece to your bench, offsetting the straightedge enough to locate the cut. The straightedge must be parallel to the workpiece edge.

You can upgrade the basic straightedge by attaching a short piece across one end of it at 90° to make a T-square. Because it's already square, a T-square requires very little time to set up. Just put it in position, clamp, and you're in business.

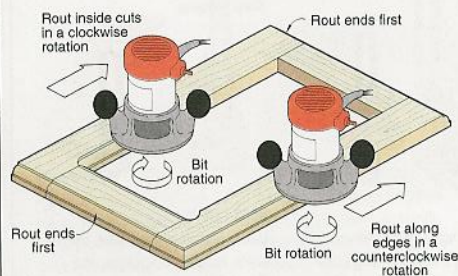

Handheld operation

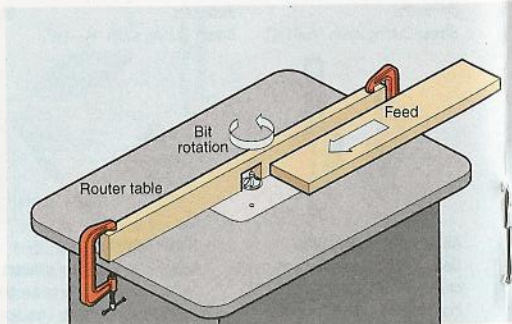

Router-table operation

**Piloted bits** guide a router along the edge of a workpiece or pattern whether curved or straight. There's a ball bearing or bushing on the end of the bit so the workpiece must be thick enough to accept the cutter and bearing at the same time.

The bearing keeps the cut width consistent. It also duplicates the surface it

rides against so the edge must be smooth to avoid transferring imperfections into the cut edge. Be aware that when edge-forming with a piloted bit, less than half of the router base will be supported, and at the corners, even less.

**Edge guides** often come as an accessory with a router, or you can buy one.

## climb-cutting—routing in the wrong direction

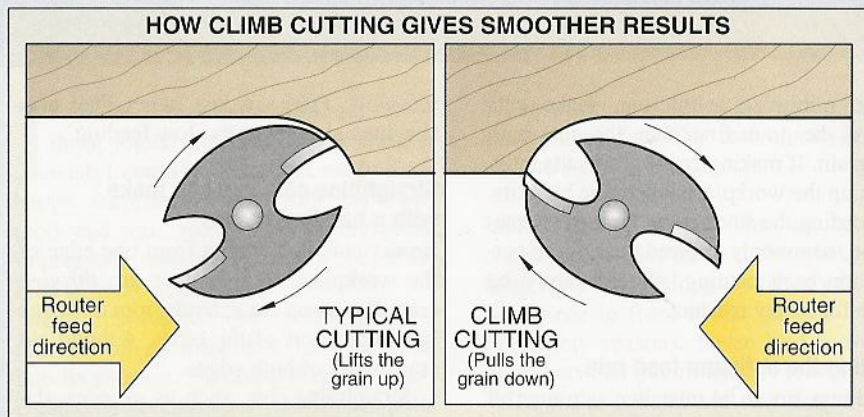

**WARNING:** Firmly control router with both hands during a climb-cut operation because climb-cutting causes the bit's cutting edge to "climb" out of the work and pull the tool in the direction of feed.

Occasionally it makes sense to rout in the direction opposite the bit's rotation. Back-routing can minimize splintering problems often encountered on the ends of pieces. It also creates a burnishing effect on wood that leaves it very smooth. For this reason, some woodworkers use the technique for their final edge-routing pass. However, it is not considered a safe procedure, so do it carefully and sparingly.

Practice climb-cutting on scrap before attempting it on a project. Use small, sharp bits (never over 2" in diameter), and take small

bites—no more than  $\frac{1}{8}$ " with small bits or  $\frac{1}{16}$ " with larger bits. And, always clamp the workpiece securely to the bench.

While climb-cutting, the bit pulls the grain down as the cutting edges enter the work, as shown in the drawing above. Because a climb-cutting bit doesn't pull itself into the work, you can set it to full-cut depth and make multiple passes until you reach the final depth. Hold the router firmly because it will feel light and want to run away from you. Feed the router at the usual rate or slightly faster. Make cross-grain cuts first.

Warning: Do not back-rout on a router table. If you feed the workpiece left to right, the spinning bit will try to pull the piece and your fingers toward it very quickly.

Mount it to the router base, then set its edge so the gap between the bit and the guide equals the desired spacing.

You can make a *box guide* by fastening two straightedges together between two crosspieces. Space the straightedges so your router slides freely between them but without any slop.

Box guides work great for routing on flat surfaces. Just clamp the box in place and use both hands to move the router. Gluing sandpaper to the underside of the guide will help keep it in place.

Auxiliary *sub-bases* can be made any shape or size you want. They're simple to make, and  $\frac{1}{4}$ "- or  $\frac{3}{8}$ "-thick material, such as tempered hardboard, plywood, or plastic, will do. Use the router's sub-base as a pattern to layout the mounting holes.

### How to rout on the contour

Devices needed to rout contours are simple. Piloted bits, as already mentioned, use a bearing to guide the router along a contoured edge. Varying radii can be achieved by using bearings of different diameters. However, the radius of the cut cannot be less than the bearing diameter. Some edge-forming bits do not have bearings, but you can buy and attach them to the shank above the cutter (similar to pattern bits).

**Template guide bushings** look like hollow tubes that fit into the center hole of most sub-bases and guide a router around a template or pattern. In use, the bit extends through the inside of the bushing and beyond the bottom of the router base. When routing, hold the guide bushing against the pattern edge.

Router guides work for straightline routing, but some of them can be converted to follow contoured edges too. If your guide has curved edges or a radius guide, use them. If the guide has only a straight-edge, make a radius guide for it. Simply cut an arc of the same radius as the one you want to follow into one edge of a



Scrap wood clamped to the workpiece serves as a straightedge guide for the router to follow. This router's base plate has one flat edge to help guide.

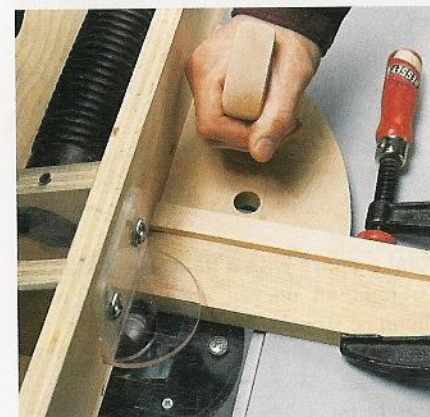

A shop-built pushblock helps move the workpiece past the built to rout end grain. Clamping the workpiece to a push block keeps it square to the fence.

wooden block. Then, attach this block to the guide's straightedge.

### How to go in circles with a router

To cut circles, you rotate the router around a pivot point using a circle jig, trammel, pivot guide, or compass jig. A trammel serves as an extended sub-base with a pivot point offset from the router bit. The farther the bit is from the pivot point, the larger the circle will be. Trammels can be made infinitely variable so they'll cut circles of almost any diameter. You can buy circle jigs or make one, as shown on page 29, from leftover stock.

**Making rabbet cuts with a bit**

A rabbeting bit can make rabbet joints and cut rabbets to hold panels of wood or glass, and let in back panels on cabinets. It works on curved as well as straight work, something your tablesaw or jointer can't do.

To cut rabbets with a handheld router, mount a bearing of the diameter that will allow the bit to cut to the desired width. Then, set the bit to cutting depth. If the cut exceeds 1/4" square, make multiple shallow cutting passes to reach final depth.

Typical rabbeting bits come with either a 1/4"-diameter cutter and a 1/2" bearing for cutting 3/8"-deep rabbets, or a 1 3/8"-diameter cutter and a 3/8" bearing for cutting 1/2"-deep rabbets.

Expand the versatility of a rabbeting bit with a matched set of high-speed bearings like the one shown, *bottom, next page*.

**Joint a board with a handheld router**

To joint an uneven edge on a board, clamp a straightedge to the top of the piece so it aligns with the edge of the workpiece. Rout the edge with a 1/2" straight bit. If the board's edge is so uneven that the cut width exceeds 1/8" in some areas, saw away most of the waste.

**Working with patterns and templates**

To rout a pattern using a handheld router and pattern bit, place the pattern on top of the workpiece. On a router table, the template goes under the workpiece. When using a plunge router, position the router over an area to be routed and plunge the bit into the field. With a fixed-base router, either bore start holes in each section to start the bit in, or use the tilt-in starting technique.

Patterns can be made from a variety of materials. Tempered hardboard and thick plastic make durable patterns. The template must be thick enough so that the guide bushing can fit against it without bottoming out on the workpiece.

**Cutting wood joints**

Furniture-type joints, such as tongue-and-groove, splined edge, mortise and tenon, half-lap and cross-lap, dovetail dado, and numerous variations of the rabbet and dado, can be cut with a router.

You can buy jigs to help cut joint parts. Many of them position the stock so the bit can be centered accurately and repeatedly. A few can be used to cut the parts. You can make many of these jigs and fixtures yourself. Plans can be found in books and magazines at the local library.

**Turn your router into a stationary woodworking machine**

A good table converts a router into a stationary machine capable of performing many additional tasks. Many woodworkers prefer to work on a table because they're convenient and provide more control over the cutting operation.

On a router table, the fence serves as the straightedge. The bit and fence remain stationary so you move the workpiece along the fence. For safety reasons, never feed a workpiece between the fence and the spinning bit.

If you can mount a template guide bushing in the center hole of the insert plate, you have the start of another guide system that can be used with many jigs.

Make the jig, then cut a slot through the jig's base. Size the slot to fit one of your guide bushings snugly. To use, mount the guide bushing in the plate, install the bit to cutting height, and align the guide bushing with the slot in the jig. Turn on the router, slide the jig over the bushing.

**Cuts on the router table**

All types of grooved cuts, whether dados, grooves, rabbets, or sliding dovetails, can be made on a router table. For most jobs, use a bit the same diameter as the width of the groove you want to cut. If you need a groove that's not standard bit

size, make two passes with a slightly smaller bit to get the width needed. In this case move the fence away from the bit to avoid a climb-cutting situation.

To cut rabbets on a table, first elevate the bit to cutting depth, then position the fence to establish cut width. If the rabbit's width exceeds the bit's diameter, move the fence away from the bit to make additional cutting passes.

For other grooved cuts, many woodworkers prefer to use up-cutting spiral bits because (when inverted under a table) they pull the chips and dust down and out of the cut. Also, feed the workpiece with the crown down when possible (see *page 30*) and use featherboards or holddowns to hold the workpiece against the fence and flat on the table.

Stopped cuts get a bit more tricky on a router table because the cut is made on the underside of the workpiece where you can't see it.

To make a half-blind cut, first mark your cutting line on the face of the workpiece where it will be visible to you. Next, using a small square, mark the bit's cutting edge on the fence or on the table. (A piece of masking tape on the table's face will do.) Then, start the router, move the workpiece into the bit, and stop the cut when the line on the work aligns with the bit mark.

To make a full-blind cut on a table, follow the same procedure except mark the bit's diameter on the fence or table and both stop and start lines on the work-

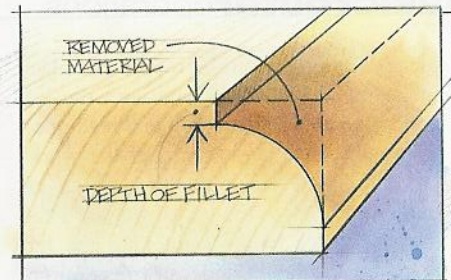

By extending a roundover bit, you can form an edge with an interesting, decorative fillet like this.

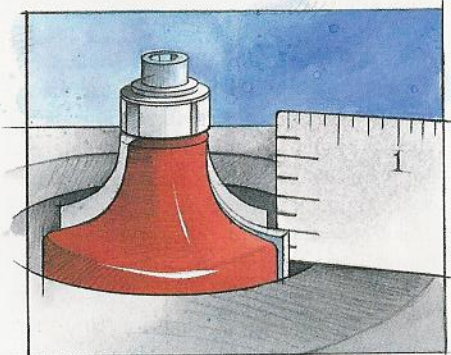

It's best to use a rule when setting the bit for cutting fillet depth precisely.

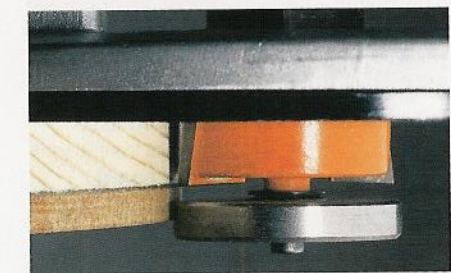

Interchangeable bearings of varying diameter control the cutting width of rabbeting bits.

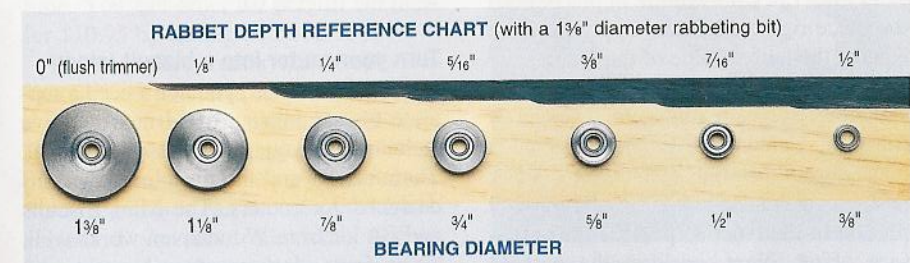

Samples of cutting depths made by different rabbeting bits and bearing combinations.

piece. Then, turn on the router and place the work against the fence with the left end suspended and its right end resting on the router table. Slowly lower the workpiece completely onto the bit with the left mark about 1/2" to the left of the bit. Feed the workpiece to the right until the left mark on the fence and workpiece align. Now, feed the workpiece from right to left until right marks on the stock and fence align.

**Use stops for cutting multiple pieces**

To blind-rout multiple pieces fast and accurately, clamp stops to the router table fence. Lay out the cut on the workpiece, then measure from the left end of the cut to the right end of the piece. Using this measurement, locate the *right* stop by measuring to the right from the left edge of the router bit.

To set the *left* stop, measure from the right end of the cut to the left end of the workpiece. Use this measurement starting from the right edge of the router bit. Clamp the stops in place, position the piece against the right stop, turn on the router, drop the workpiece on the spinning cutter, and then feed the piece to the left until it touches the left stop.

**Joining or straightlining a board**

If your table has a split fence, first align both fence sections with the front edge of the bit. Then, move the outfeed side of the fence forward equal to the thickness of the material you want to remove—typically 1/16". Lock the section in place. Feed the piece right to left and apply pressure against the outfeed side of the fence.

To joint a board on a router table with a one-piece fence requires one fence modification. Cement or double-face-tape a piece of thin material, such as a 1/16"-thick piece of plastic laminate, to the outfeed portion of the fence to provide the necessary offset. Next, position the outfeed table so its face aligns tangent to the out-

side cutting edge of the bit. Note: This will leave the infeed end of the fence offset at a distance equal to the thickness of the laminate and tape. Then, holding the workpiece against the fence, feed it from right to left.

You can edge-form round or contoured pieces on a router table without a fence. It requires a piloted bit and a start pin or starting block to serve as a pivot point for the workpiece. To do this, first position the workpiece against the start pin or block, then slowly rotate it into the cutter until it contacts the bearing. Feed the piece against the bit's rotation. Draw it away from the bit when done.

The start pin should be inserted into the table top an inch or two from the bit. You also can clamp a start block in about the same position on the table. Always clamp a guard over the bit so you can't get your fingers near the cutting edges.

**Round-over bit becomes a beading bit**

To cut a standard round-over, adjust the bit so that the bottom of the concave cutting edge aligns flush with the router base (handheld) or the surface of the router table. Use a flat block of wood to check the setting. Next, test the setting on scrap stock. Adjust the bit until you are satisfied with the cut, then rout your workpieces.

Add more class to a round-over by setting up the same bit to cut a fillet. See the two drawings on *page 21*. Raise the bit above the table to set the depth that you want the fillet to be.

**Turn your router into a biscuit joiner**

If you own a router, you don't need a separate biscuit joiner to add this effective technique to your woodworking arsenal. There are several biscuit-joinery systems designed for routers. The Mini Biscuits and Bit kit from Woodhaven works well. Their 6mm slotting cutter forms a slot that's the right size for holding their 1/4"-

thick, 1 1/4"-long biscuits. In addition to joining flat stock and panels, you also can join cabinet face frames with rails and stiles as narrow as 1 1/2".

**Plenty of router table options**

You have numerous table options depending on your shop space, budget, and routing needs. Some woodworkers buy or make just a tabletop and mount it to a wall. In tight spaces they'll fold the top out of the way when not needed.

Others mount their router table to a table saw to save space. Several firms sell router tables for attaching to the edge of 27"-wide saw tables.

Owners of saws with large extension tables frequently install their router in the tabletop. This enables the saw's rip fence to double as the router fence, although special router-table fences may provide more accuracy. This approach involves either building a special extension or buying one, however. But, if you have the space, it keeps your router always handy.

Portable, bench-top router tables, with their small foot prints, overcome tight space problems too. When they're not needed, they can be stored, or at least moved out of the way.

You'll find many commercial portable router tables and accessories available, but they're also easy to build. The bench-top router table designed by *WOOD*® magazine, *above right*, is a simple, inexpensive, highly-portable unit with features that will keep you routing for a long time. You can order the plan WT-#1001, for \$10.95 by calling 800/572-9350.

Floor-standing router tables offer advantages not available on bench-top units. For instance, they usually have larger tops (up to 48" wide) to support larger workpieces, and they'll accept larger routers. Some leg stands can be converted into a cabinet if you need additional storage. They often have better dust collection capability, too.

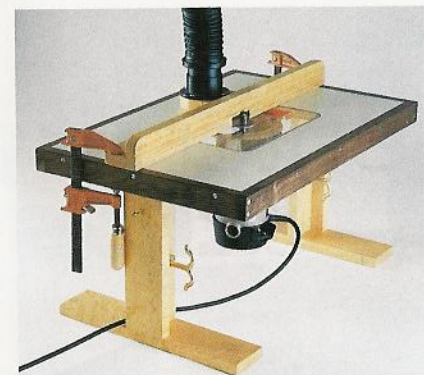

You can get the plans for building this low-cost bench-top router table. See text for information.



This versatile, cast-aluminum router table offers three different routing functions.



Here, a table and fence package has all the components you need to get started routing.

Making your router  
into many tools

# router jigs & tips

An accessory such as this jig allows you to easily cut mating dovetail joints for drawers and other projects with your router and a dovetail bit.



**D**ovetail joints have long been the mark of craftsmanship. Most simple, inexpensive dovetail jigs will help you make tight-fitting half-blind dovetails quickly and easily. By the time you've completed two drawers, you'll wonder why you hadn't done it before

## Key steps to great-looking half-blind dovetail joints

A dovetail jig's template or comb has a series of equidistant-spaced fingers that control the router as it cuts the dovetails. A standard  $\frac{1}{2}$ " template works with a  $\frac{1}{2}$ " dovetail bit and typically has fingers spaced  $\frac{7}{8}$ " apart, as shown, *opposite top*. However, some templates may have different spacing, so measure to be certain.

Measure the finger spacing on the template of your dovetail jig, then make the width of your workpiece an increment of the finger spacing. For example, a template with  $\frac{7}{8}$ " finger spacing works nicely with  $3\frac{1}{2}$ "-,  $4\frac{3}{8}$ "-, or  $5\frac{1}{4}$ "-wide pieces.

This way you can have identical half-dovetails at the top and bottom of the drawer as shown *opposite center*.

Next, select your stock and plane or resaw it if necessary. Drawers usually are made with  $\frac{3}{4}$ "-thick fronts and  $\frac{1}{2}$ "-thick sides and backs. Check the manual for your dovetail jig to determine if the jig has size limitations—some models require using material of a minimum thickness. For example, the  $\frac{1}{2}$ " template of one popular jig requires  $\frac{1}{2}$ "-thick stock. Another  $\frac{1}{4}$ " template calls for  $\frac{3}{8}$ "-thick drawer fronts,  $\frac{5}{16}$ "-thick sides.

## Next, cut the drawer parts

Cut the drawer parts to size, making sure the cuts are square. Then, arrange the parts as shown *opposite bottom*. Mark the top edges and number all of the mating inside corners. Work each corner set as a pair, and use the marks for orientation.

Set up your jig as instructed by the manual. Mount the correct guide bushing

to your router's sub-base. A  $\frac{1}{2}$ " template usually requires a  $\frac{7}{16}$ " outside diameter bushing. Secure the correct dovetail bit in the collet, then, using a metal rule, adjust the bit height according to the manual.

Test the jig settings with scrap stock that's the same dimension as the workpieces. Position the drawer side vertically, the drawer front or back horizontally, in the jig. The inside (numbered) surfaces should be visible to you, or facing away from the jig. Both pieces should be touching the jig stops and tight against each other, with the face grain of the horizontal piece flush with the end grain of the vertical part.

Rout the test pieces, feeding the router left to right, moving the router in and out of each template finger. Work slowly, especially near the ends of the pieces, to ensure clean results.

Remove the test pieces from the jig and assemble them to check their fit. The dovetails should slide together with firm hand pressure or light tapping with a rubber mallet. If the joint requires more pressure or doesn't go together at all, lower the bit and repeat the cuts. If the joint goes together sloppily, you simply need to raise the bit and recut.

Next, check if the sides align flush with the end of the front or back. If they don't align, increase the length of the dovetails by adjusting the template in, or away from the router. If the dovetail cuts are too long and the workpieces go more than a hair past flush, move the template out, or toward the router. If you run into grain splintering at the end of the cut, butt a scrap piece along side the workpiece.

When satisfied with the settings, you are ready to rout the drawer parts. Start with corner 1, placing both pieces with the same number in the jig. The numbered ends should be together and oriented as described above. To speed things up, you can place corner sets on both ends of the jig and rout them at the same time.

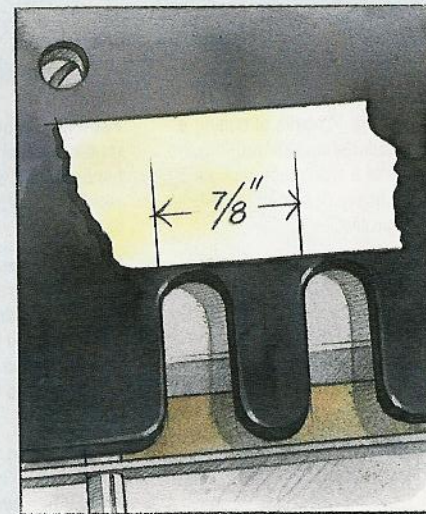

Measure finger width on dovetail template.

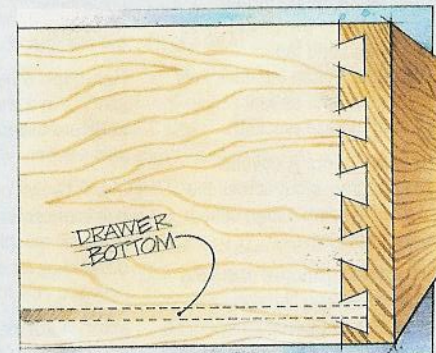

Size parts to get half tails at top and bottom.

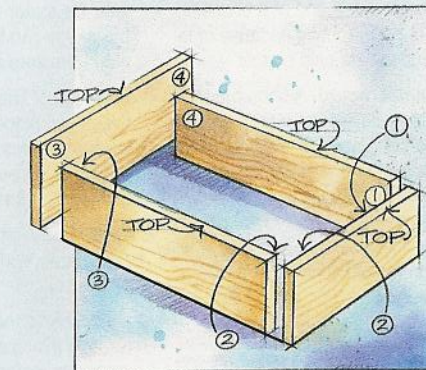

Mark edges and inside corners of each drawer.

# routing and woodworking

## wordstoknow

**Beading.** Process of cutting a particular shape (bead) into the edge of a workpiece using a bit specifically designed to produce that profile.

**Cross-lap; Half-lap.** A joint formed when two boards cross or meet at an end. Each overlapping board is notched one-half their thickness so joint equals thickness of each piece.

**Dado.** A cut that runs perpendicular to or across the grain of the workpiece.

**Groove.** A cut that runs parallel with the grain of the wood.

**Dovetail.** A flaring or fan-shaped tenon (pin) that's wide on the end and tapers inward. Part of an interlock joint that mates with an identically shaped mortise (socket).

**Dovetail dado.** A dovetail-shaped groove cut across the grain of a board. Often called sliding dovetail.

**Edge form.** Process of cutting or shaping a profile along the edge of a workpiece as opposed to cutting into the interior surface of board.

**End grain.** The wood grain exposed at the end of a board. Critical in routing because of its tendency to chip or split.

**Featherboard.** A shop-made safety device cut from a board with one end cross cut at an angle and with a series of saw kerfs cut into the end to form flexible  $\frac{1}{16}$ "- to  $\frac{1}{8}$ "-wide fingers. Device must be clamped in position to hold workpiece in desired position for working.

**Half-blind cut.** A cut that starts through one edge but stops before reaching the opposite edge.

**Feed.** The movement of the router along or across the stationary stock, also the movement of the stock along the stationary router.

**Infeed; Outfeed.** Position of the workpiece in reference to the bit on a router table. When board moves toward the bit it is in the infeed position. When moving away from the bit it is in the out-feed position.

**Finger joints; Box joints.** A joint made by cutting alternate straight pins and mortises on mating pieces.

**Full-blind cut.** A cut that starts and stops between the edges of the workpiece.

**Half-blind dovetail.** A dovetail joint cut in a way that when the parts are assembled, the dovetails are only visible on one side.

**Jig.** A device or fixture used to position, center, or align a workpiece for machining, e.g. a dovetail jig for a router to cut pins and tails for a dovetail joint.

**Miter.** A cut made obliquely across the grain of wood.

**Miter gauge.** A router-table accessory for guiding a workpiece past the router bit. The head of the gauge can be rotated left or right from zero to 45 degrees.

**Miter joint.** The connection between two pieces that have similar angular cuts, such as the angular 45 degree cuts of a 90 degree angle frame.

**Miter slot.** A slot cut into the router-table surface to accept a miter gauge.

**Mortise and tenon.** A woodworking joint made with a square or rectangular projection (mortise) cut on the end of one

piece to fit into a mating cavity (mortise) cut into the second piece of wood.

**Push stick.** A narrow safety device used instead of hands to move a workpiece past the router bit.

**Rabbet.** An L-shaped recess, usually one-half the thickness of the stock, cut along the edge or end of a board to accommodate another piece.

**Rabbet joint.** A wood connection in which one part is L-shaped and receives the end of the mating piece. This joint is stronger than a butt joint and shows less end grain.

**Splined edge.** Two pieces joined and reinforced with a strip of wood or spline, such as a hardwood edging surrounding a plywood top. Mating grooves are cut into the adjoining pieces and then a strip of suitable wood is glued into the groove.

**Split fence.** Router table fence made up of two independent parts. Provides for more exacting adjustment and positioning of fence around the router bit.

**Stopped cut.** A router cut that does not extend along the full length of the workpiece.

**Through dovetail.** A dovetail joint cut in such a way then when the parts are assembled, the dovetails are visible on both sides.

**Tongue and groove.** A wood joint constructed by cutting a tongue into the end or edge of one part and a matching groove into the end of the mating part. Often used to join case sides to top and bottom panels.

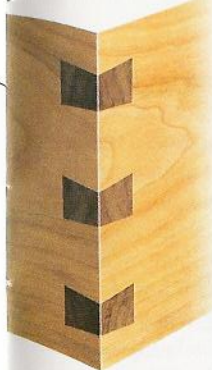

Dovetail keys of contrasting wood add a decorative touch to this mitered box corner.

### A jig for routing dovetail keys

Make the jig shown below right. It was designed to be used with a mitergauge slot in the router table. If your router table doesn't have a miter slot, modify the jig and use the table's edge as an edge guide.

Cut a slot through the jig where the dovetail bit will pass when making a cut. To do this, mount a dovetail bit, and raise it to cutting height. (An  $\frac{1}{16}$ "-diameter bit with an  $8^\circ$  angle and  $\frac{1}{2}$ " shank was used to cut the key slots in the  $\frac{3}{4}$ "-thick stock.)

Mark the point where the bit contacts the jig. Next, saw through this area of the jig so the bit can pass through. Now, pass the jig across the spinning dovetail bit.

Assemble a test corner from scrap material of the same thickness as the wood used in the box you want to decorate. Also, mark a vertical centerline on the inside of the jig above the V.

Lay out the dovetails on the box corners. You can space them uniformly or use whatever arrangement you want. In the box corner shown above, one dovetail was placed in the exact center, and the others split the space on either side. Mark the centers of each dovetail to be cut.

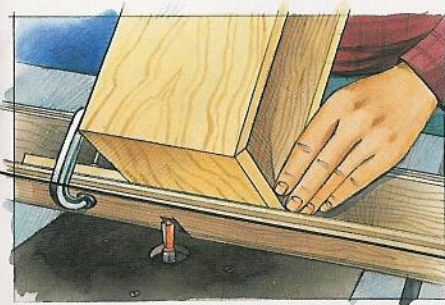

Rotating the box  $180^\circ$  after the first cut ensures symmetrical spacing of dovetail slots on all box corners.

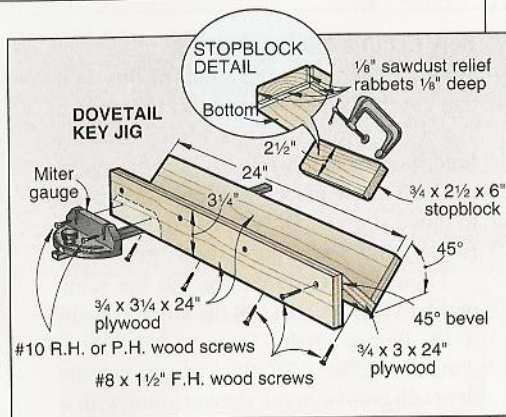

Place the box on the jig, centering the dovetail with the jig's center mark. Clamp on a stop against the box. Slide the jig and box forward to cut the first dovetail. Rotate the box to cut remaining dovetails.

For the keys, measure the depth and width of the dovetail slots. Make the key stock  $\frac{1}{16}$ " thicker than the depth of the slot. Rip it  $\frac{1}{16}$ " wider than the widest part of the dovetail slot.

Using the same dovetail bit, raise it  $\frac{1}{16}$ " higher than the thickness of the key stock. Set the fence so the bit just cuts into the key stock at table height. Rout the edge. Rotate the stock end for end, keeping the same face down to rout the second edge. Test-fit. Too wide? Move fence forward and recut. Cut the key stock into lengths about  $\frac{1}{4}$ " longer than the dovetails. Glue in the keys so they extend on both ends. After the glue sets, saw off the excess.

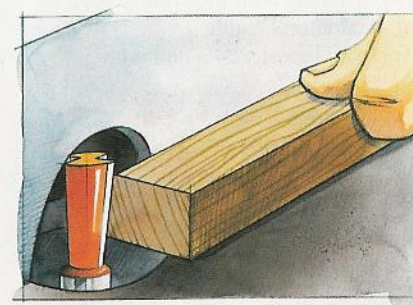

Cut key stock with the same dovetail bit. Rout both faces, then test fit. Recut as needed to make it fit.

### How to cut a sliding dovetail

With a router table and a pair of bits, you can cut this super-strong joint to use in a variety of projects. Tight-fitting versions hold workpieces firmly without fasteners and still allow pieces with opposing grain to move slightly. Or, you can make loose-fitting joints so the parts slide freely.

Typically, you make the tail the same width as the thickness of the stock you cut it in. For example, to join a 1/2"-thick drawer side to a 3/4"-thick front, cut the dovetail groove in the drawer front with a 1/2" dovetail bit and cut a 1/2" wide tail in the drawer side.

To start, mark the center of the dovetail groove on the workpiece. Chuck a straight or spiral bit in the router. It should be at least 1/16" narrower than the thinnest part of the dovetail cut, as shown *top right*. For example, in 3/4"-thick stock, you might cut a 3/8"-deep groove with 14° walls, so use a 1/4" straight bit set 1/32" deep. Next, set the router table fence so the cut will center exactly on the bit. Now, proceed to hog out most of the groove's waste. Do this to all workpieces before doing the next step.

Install the dovetail bit and adjust it to full cutting depth but leave the fence where it was. Make the cut as shown at *right*, using scrap to back up the cut.

Use scrap stock while adjusting the router to make the tail cut. To adjust, leave the bit at the same cutting depth. Lay a rule on the router table, and adjust the fence so it aligns with the cutting edge of the bit at tabletop height.

Stand the workpiece on end with either face against the fence. Cut one side of the tail, rotate the workpiece as shown, and then cut the other side of the tail.

Test-fit the tail in the dovetail groove. It should slide into the groove with firm hand pressure. To adjust the tail width, move the fence out. If there's a gap between the pieces, lower the bit slightly and recut. If there's a gap at the bottom of the groove, raise the bit and recut.

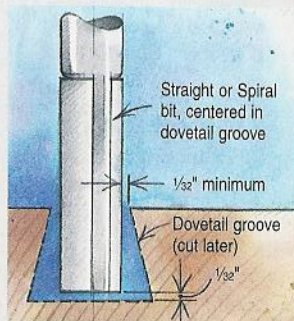

First, use a straight bit to hog out the groove's waste.

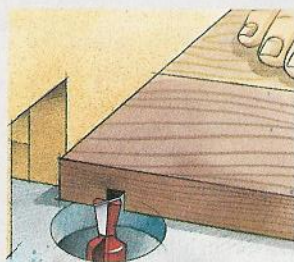

Cut one side of the tail, rotate the piece and cut the second side.

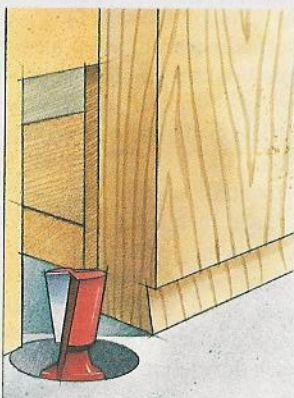

Use a dovetail bit to finish cutting the groove.



Test-fit the tail in the dovetail groove. It should fit with firm pressure.

### Here's how to make a router trammel

Start with a length of 3/4" plywood that's about 12" longer than the radius of the largest circle you want to cut. Shape one end to match the router's base. Cut the neck portion of the beam 4" wide. Center and cut a 3/8"-wide slot through the beam, shown *below*. On the bottom, widen the slot to 1" and 3/8" deep for the bolt head.

Cut the pivot base from the same plywood. Drill a 3/8" hole for the carriage bolt 1" from the front edge.

To use, first drive a screw through the base and into the center of the circle to be

cut. You can attach a temporary pivot block to the workpiece using double-faced tape and drive the screw into the block. Or, attach the jig to the underside.

Next, adjust the base and arm to position the router bit where you want the cut, then tighten the wing nut. Start the router and rout the circle using a straight bit.

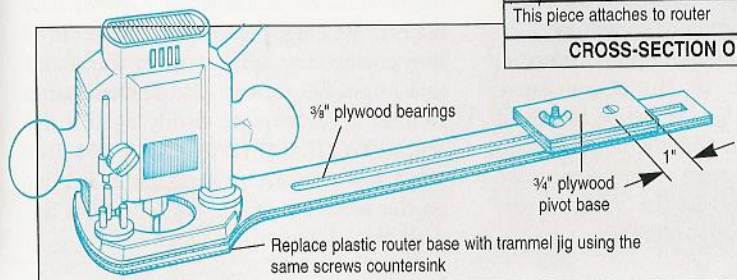
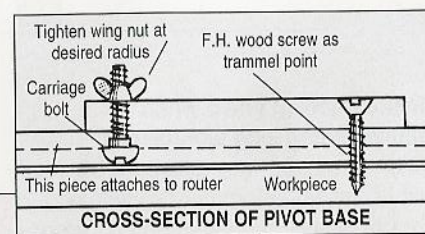

This shop-built router trammel has infinite adjustability.

### How to rout door-hinge gains and other recesses

A shop-made hinge-mortising jig, like the one shown at *right*, will enable you to cut precise gains for door hinges. Make it from 1/4" plywood, plastic, or MDF.

Measure the hinge. Next, select the bit and guide bushing to use for routing the mortise. For small hinges, a 1/4" straight bit and a 7/16" o.d. guide bushing make a good combination. Calculate the bit offset ( $7/16 - 1/4 / 2 = 3/32"$ ). Add twice the offset (D in the illustration) to the length (B) of the mortise window. To calculate the window depth (A), add the offset plus an additional 3/4" to the hinge width.

If you have a plunge router, rout the mortise window in the template. Or, use a compound miter saw and plunge-cut the three window edges. Finish the cuts with a handsaw, then assemble the jig.

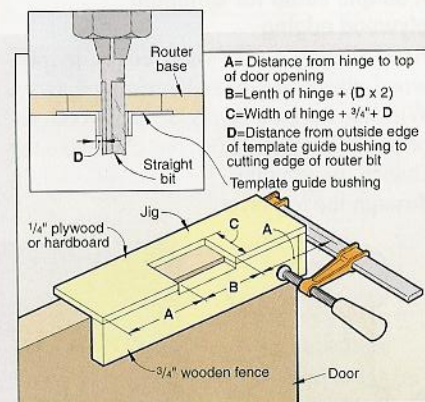

Here's a simple, easy to make hinge-mortising jig.

To use, clamp the jig to the door stile or face frame stile. Set the bit to cut to a depth equal to the hinge thickness or a hair deeper. Place the router on top of the template and guide the bushing along the template edges. Then, finish cutting away the waste. Chisel the corners square.

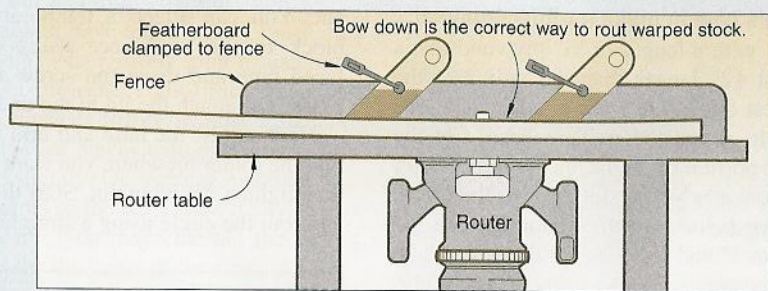

**Make it crown down when table-routing long workpieces**

When molding long boards on a router table, the workpiece must be held perfectly flat against the table top and fence in order for the bit to cut a consistent, smooth profile over the entire length of the piece. But even with the help of featherboards, bowed workpieces can cause trouble if they don't lie flat. And, narrow stock can be the worst offender.

To cut consistent profiles on bowed stock, examine the workpieces and place the bow down, as shown *above*, for best results. Placing the crown of the bow down takes any spring out of the board that might be present. Use featherboards to hold the workpiece firmly against the fence. You'll also notice that it requires much less pressure to keep the board flat on the table top in the bit zone with the workpiece lying crown down.

**A simple setup for trimming plywood edging**

After adding solid wood edges to plywood, the excess must be trimmed away. With the surface layers of hardwood veneers so thin these days, one can't take the chance of sanding for fear of cutting through the top layer.

The solution: routing the edging with a flush trim bit. But how do you keep the router from wobbling on a narrow edge without some kind of a jig?

The technique illustrated at *left* doesn't require any special jig and can be adapted to work in a number of situations. It even allows trimming two panels at a time.

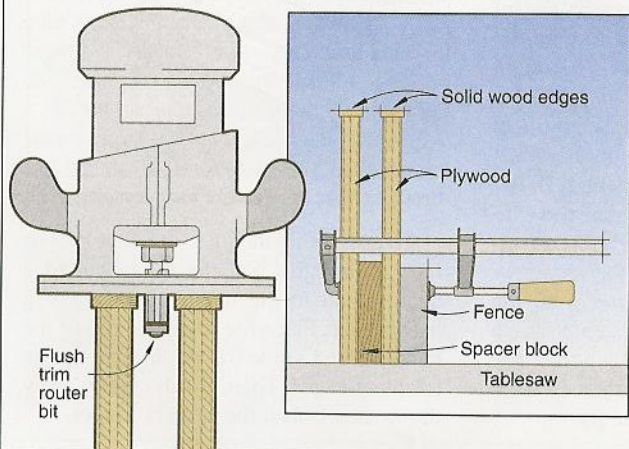

Simply clamp the panels to your tablesaw rip fence as shown, with two spacers between the pair. If you use 2x stock for spacers, your router will have a 3"-wide ledge to sit on. If the panels are too large to clamp securely to the rip fence, clamp them to a table and work sideways.

Clamping spacers between panels stabilizes workpieces for routing the solid edging flush.

**Drill bits provide perfect setup measurements**

When setting the distance from a router bit to the fence or your router table, a drill bit often can provide a quick and more accurate measurement than any ruler. For example, if you need a 1/4" spacing, simply hold the shank of a 1/4" twist-type drill bit against the router bit, as shown *below*, and move the fence until the drill bit fits snugly against both surfaces.

You can use this same technique to set the cutting depth on a router. Simply place a straightedge across the top of the bit, as shown *below*, then adjust the height of the router until the drill bit fits snugly between the router base or table top and the straightedge.

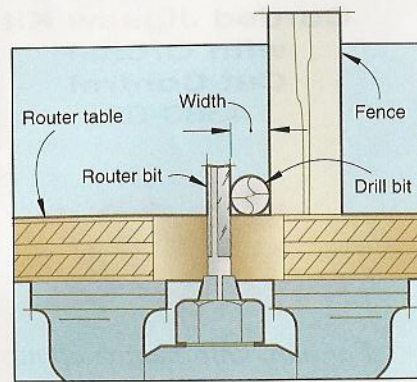
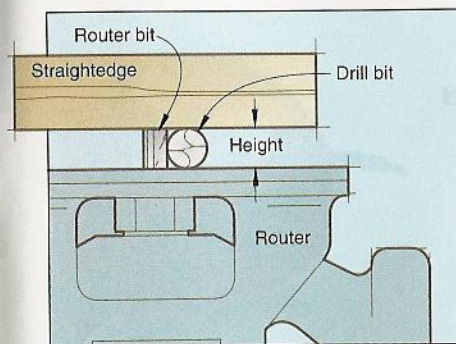

Using drill bits for quick and accurate router settings.

**Step 1**  
Start with a wide board and rout profile along edge.

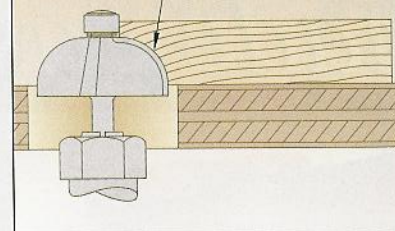

**Step 2**  
Rip molding to width on tablesaw.

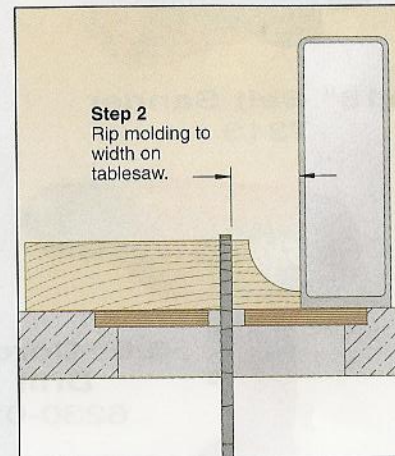

**Step 3**  
Repeat steps 1 and 2 as required.

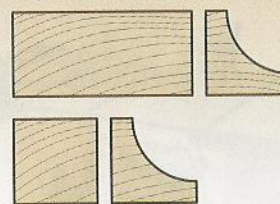

**How to safely rout narrow moldings**

Edge-routing narrow stock can be dangerous. Here's a safe way.

Starting with a wide board, joint and plane it to desired dimension. Next, rout the desired profile along one or both edges as shown in *Step 1, above*. Then, rip the molding to width on a tablesaw (*Step 2*). Repeat the process, routing and ripping subsequent pieces from the board until it's too narrow to handle safely.