

| Part | Name | # Pieces | Part | Name | # Pieces |
|------|-------------------------|----------|------|---|----------|
| W 1 | Inside Wall | 4 | M 1 | Lower Main Lock Spacer | 6 |
| W 2 | Hinge Rail | 2 | M 2 | Lower Spacer | 6 |
| W 3 | Bottom Rail | 3 | M 3 | Upper Spacer | 6 |
| W 4 | Top Rail | 3 | M 4 | Lower Main Lock Glide and Key | 6 |
| W 5 | Lid Hinge Rail | 1 | M 5 | Key Bracket and Spacer | 6 |
| W 6 | Lid Rail | 3 | M 6 | Glide Lock | 3 |
| F 1 | End Brace | 8 | M 7 | Glide Lock | 3 |
| F 2 | End Channel Filler | 6 | M 8 | Glide Lock | 3 |
| F 3 | Channel Biscuit | 4 | M 9 | Glide Lock | 3 |
| F 4 | Bottom Channel Filler | 4 | M 10 | Guard | 6 |
| F 5 | Small Support Bracket | 16 | M 11 | Upper Main Lock Glide | 6 |
| F 6 | Large Support Bracket | 16 | M 12 | Upper Spacer | 6 |
| F 7 | Hold Down Bracket | 6 | M 13 | Glide Lock | 6 |
| F 8 | Hinge Bracket | 2 | M 14 | Glide Lock | 6 |
| F 9 | Center Lock Filler | 3 | H 1 | Lower Hinge | 6 |
| E 1 | End Lock Cover Plate | 6 | H 2 | Upper Hinge | 4 |
| E 2 | Angle Brace | 4 | H 3 | Lower Hinge Spacer | 4 |
| E 3 | Glide | 8 | H 4 | Upper Hinge Spacer | 6 |
| E 4 | Lock | 6 | H 5 | Hinge Dowel | 2 |
| E 5 | Lock Spacer | 6 | L 1 | Lock Pin Cleat | 12 |
| E 6 | Lock Dowel Cover Spacer | 6 | L 2 | Lock Pin | 6 |
| E 7 | Lock Dowel | 6 | S 1 | Calmplex Code Keys | 12 |
| C 1 | Center Lock Cover Plate | 3 | to | (cut from 1/32 inch stock either as complete | or |
| C 2 | Glide | 3 | S 12 | puzzle pieces or to represent the tessellation) | (64) |
| C 3 | Glide Base | 3 | S 13 | Marker Dot | 6 |
| C 4 | Glide Bracket Cover | 6 | S 14 | Slider Bar | 12 |
| C 5 | Glide Bracket | 6 | P 1 | Plywood for Lid - 6 3/4 x 6 3/4 x 1/8 inch | 1 |
| C 6 | Center Lock Base | 6 | P 2 | Plywood for Base - 6 1/2 x 6 1/2 x 1/8 inch | 1 |

R&A Media Inc. assumes no responsibility for any errors or omissions. These drawings are intended as a guide only.

Wall Assembly

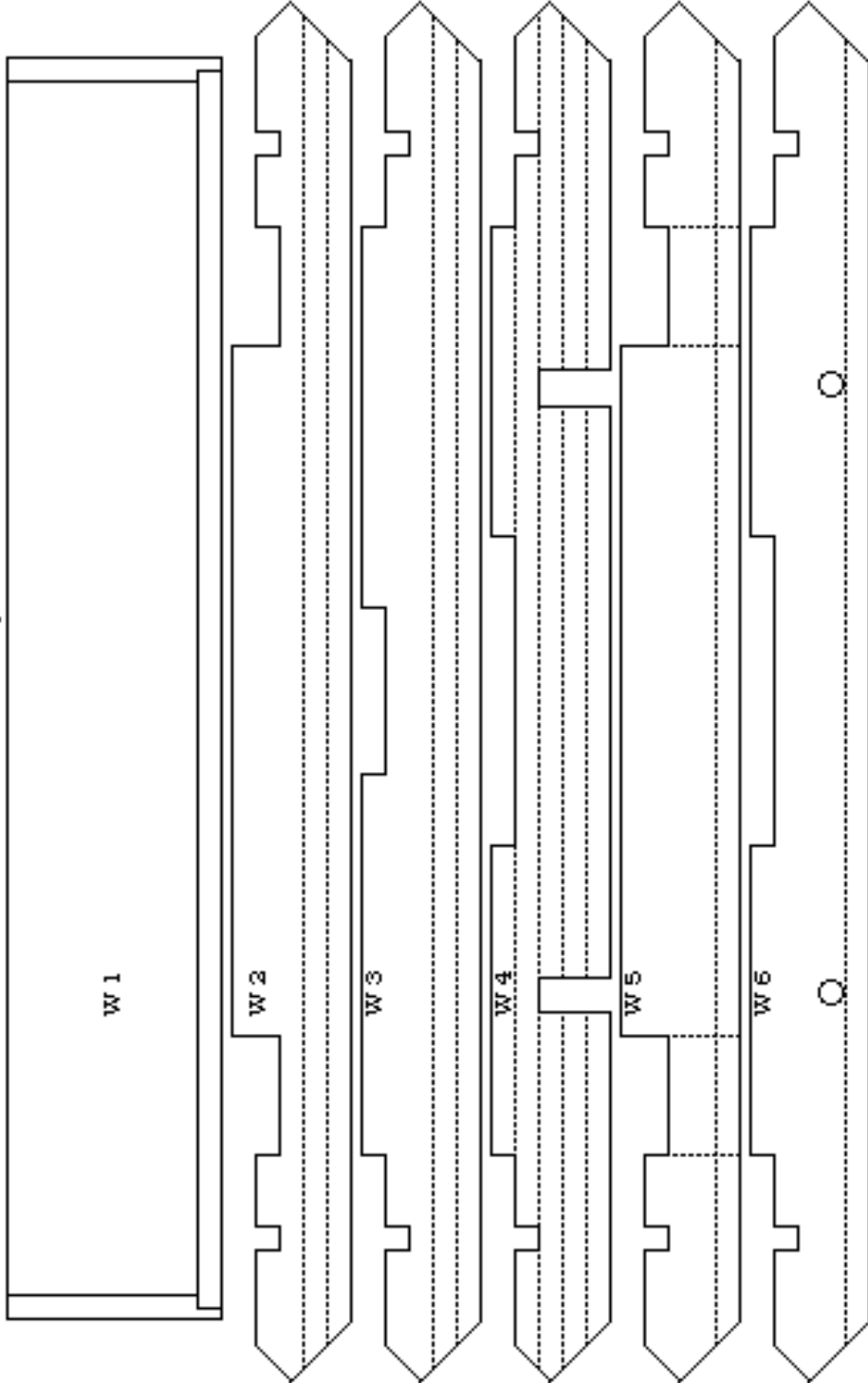

Filters



End Lock Assembly

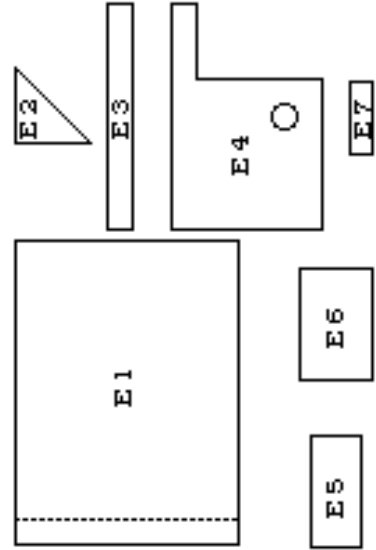

Slider and Calmplex Puzzle Group Keys



Center Lock Assembly

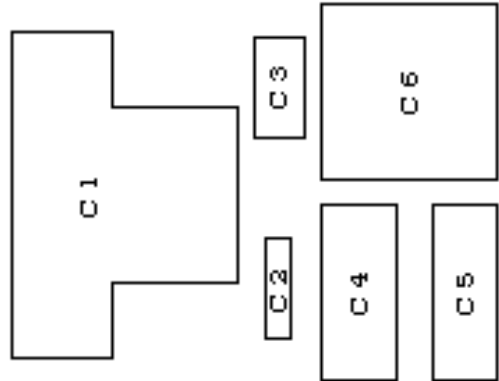

Main Lock Assembly

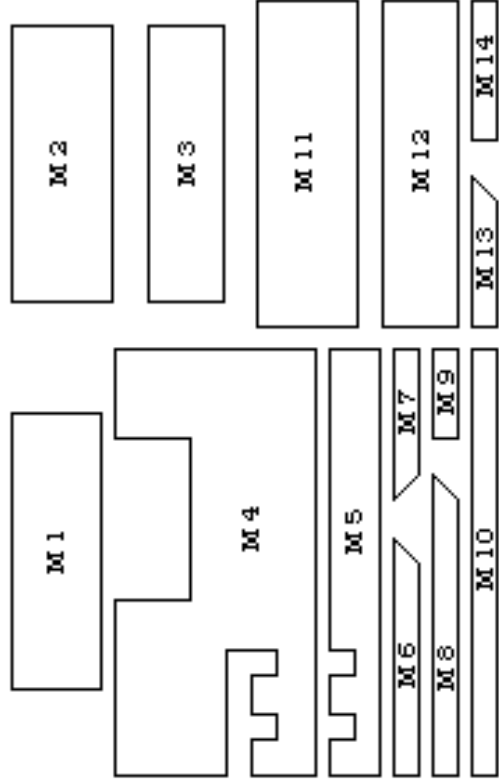

Lock Pin

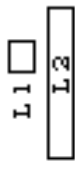

P 1 & P 2
Lid & Base
Panes
Not
Shown

Hinge Assembly



CalmPlex™ 32 Step Puzzle Box
©1998 Andrew Snowie & R. & A Media Inc.
calmplex.com

1 inch = 1 inch
31 Oct 1998

Parts
Identification

Page
2 of 11

90 in

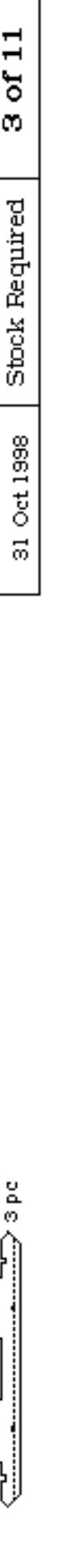
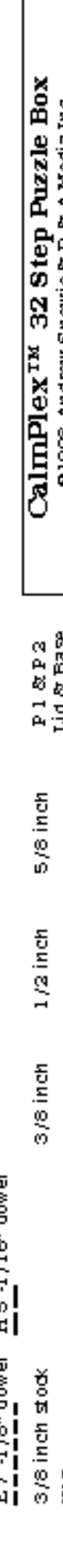
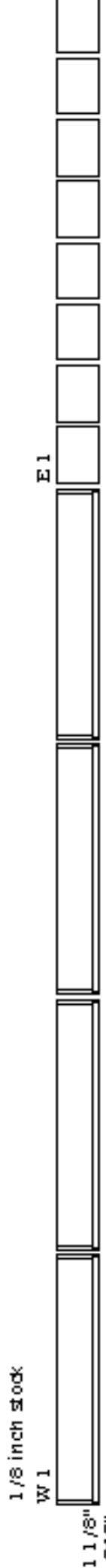

| Stock | 3/8 inch | 1/2 inch | 5/8 inch | P 1 & P 2 Lid & Base Pancs |
|-------|----------|----------|----------|----------------------------------|
| W5 | □ | □ | □ | Not Shown |
| W6 | □ | □ | □ | Not Shown |

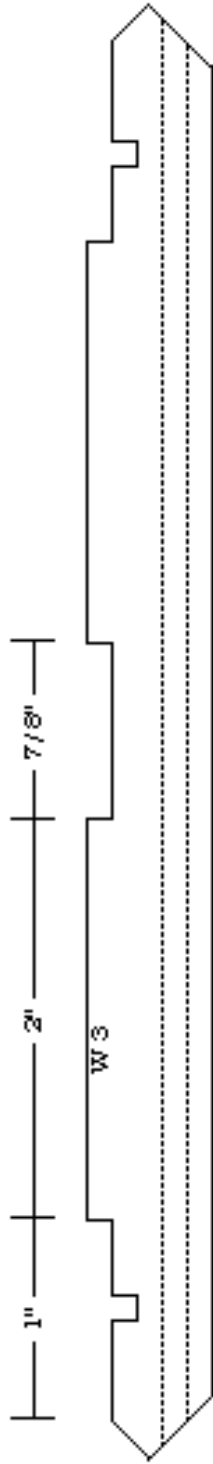
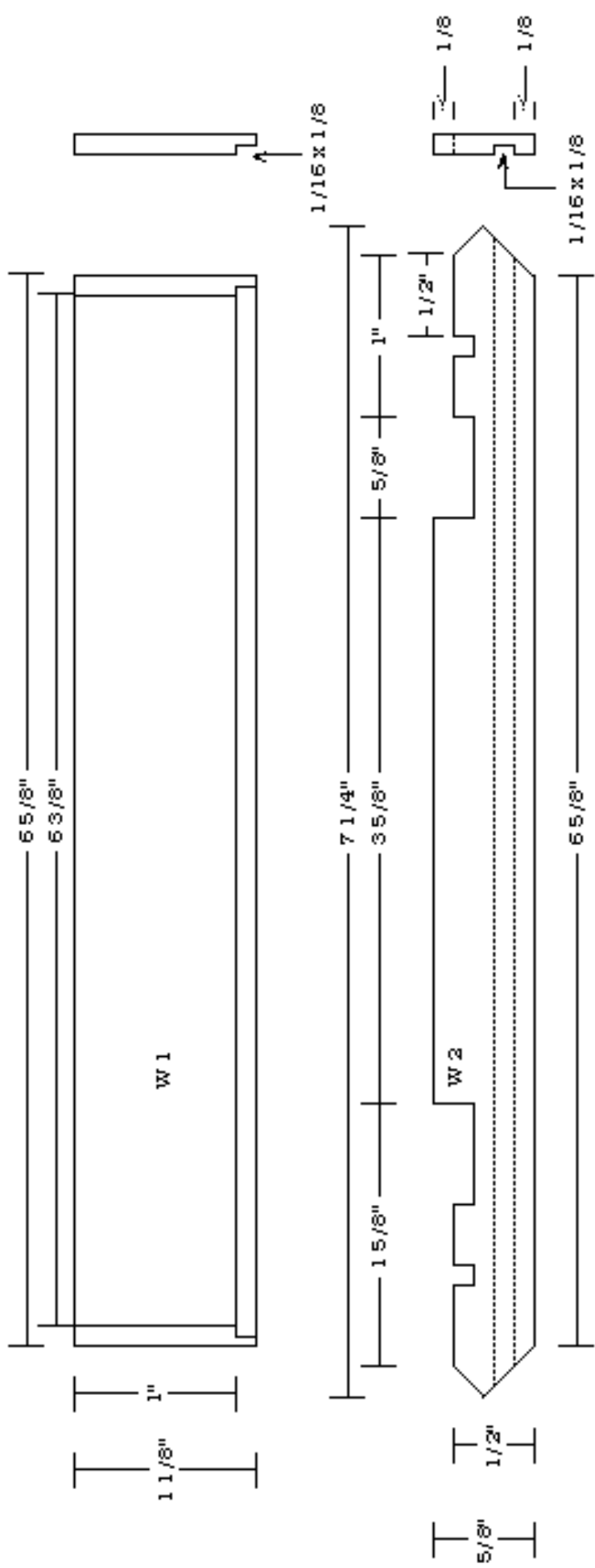

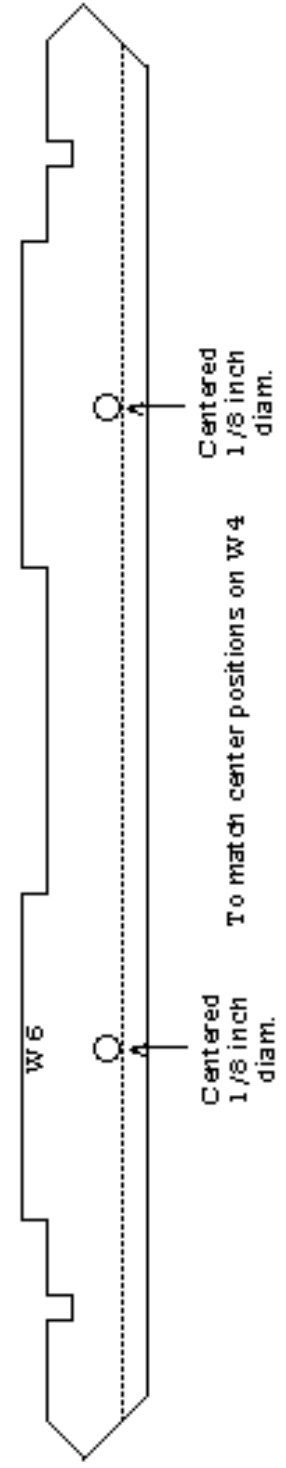
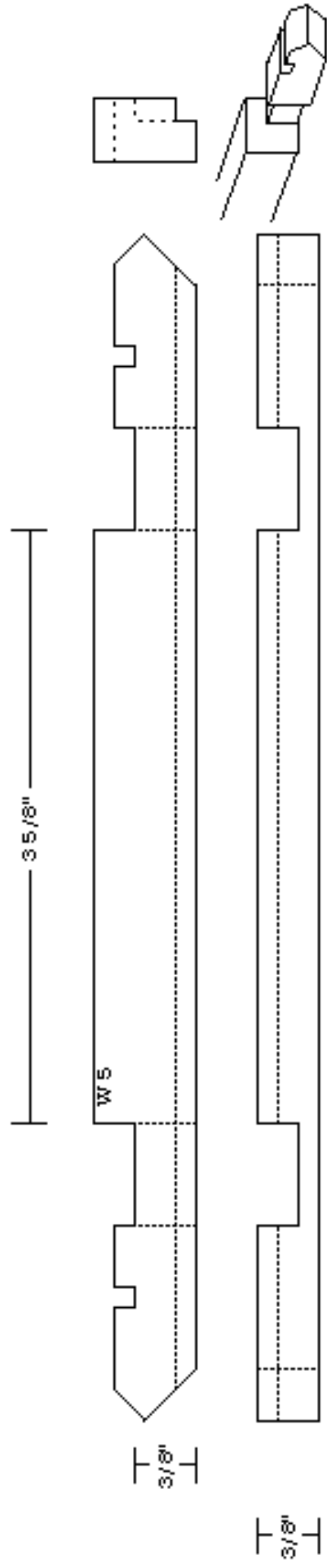
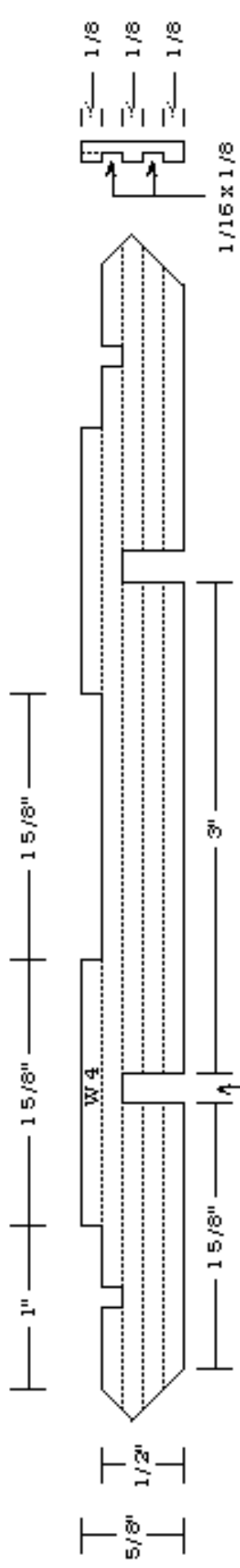

CalmPlex™ 32 Step Puzzle Box
 ©1998 Andrew Snowie & R. & A Media Inc.
 calmplex.com

1 inch = 1 inch
 31 Oct 1998

W4, W5, W6
 Dimensions

Page
 5 of 11

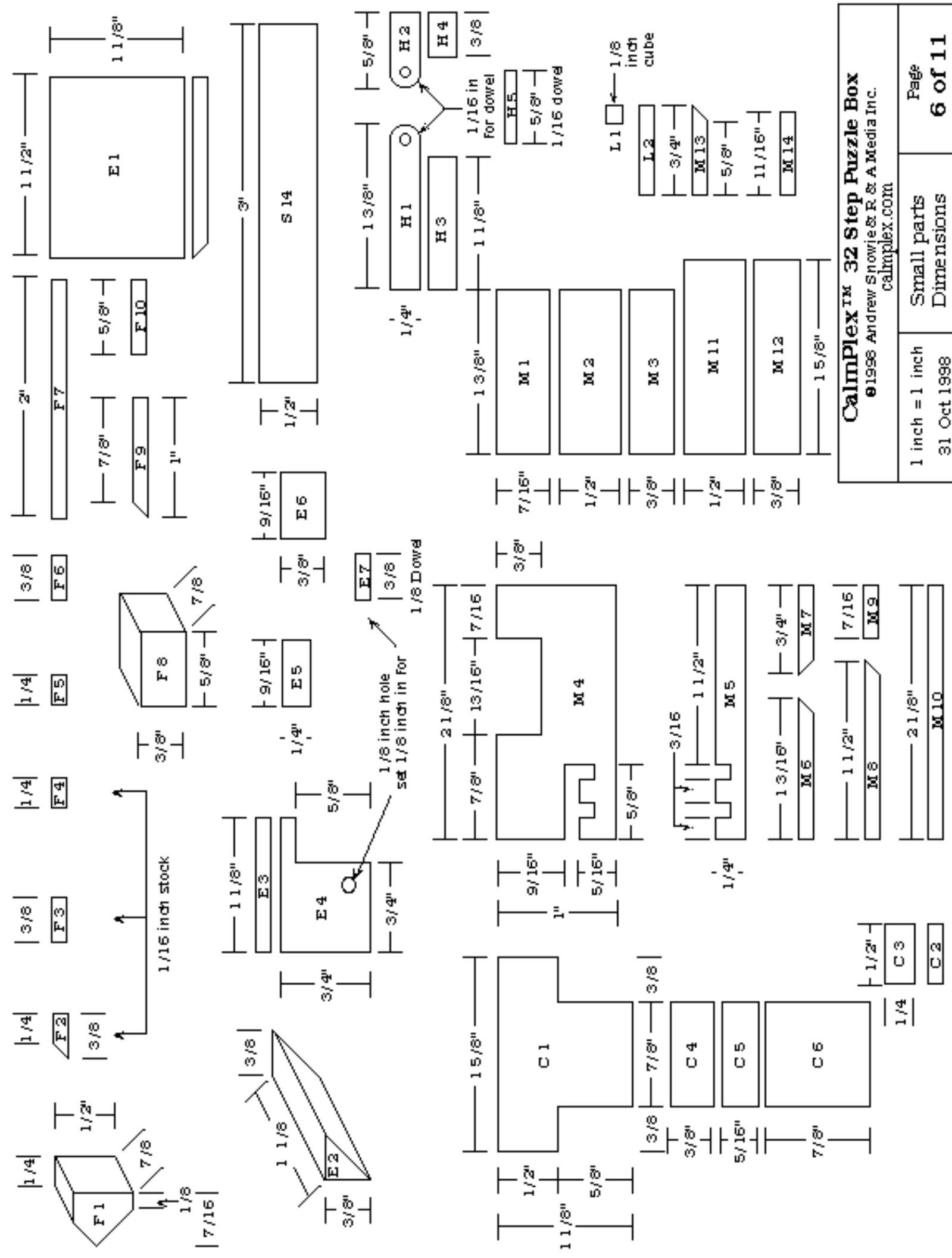

CalmPlex™ 32 Step Puzzle Box
 ©1998 Andrew Snowie & R. & A Media Inc.
 calmplex.com

1 inch = 1 inch
 31 Oct 1998

Small parts
 Dimensions

Page
 6 of 11

Center Lock Assembly
(3 Required)

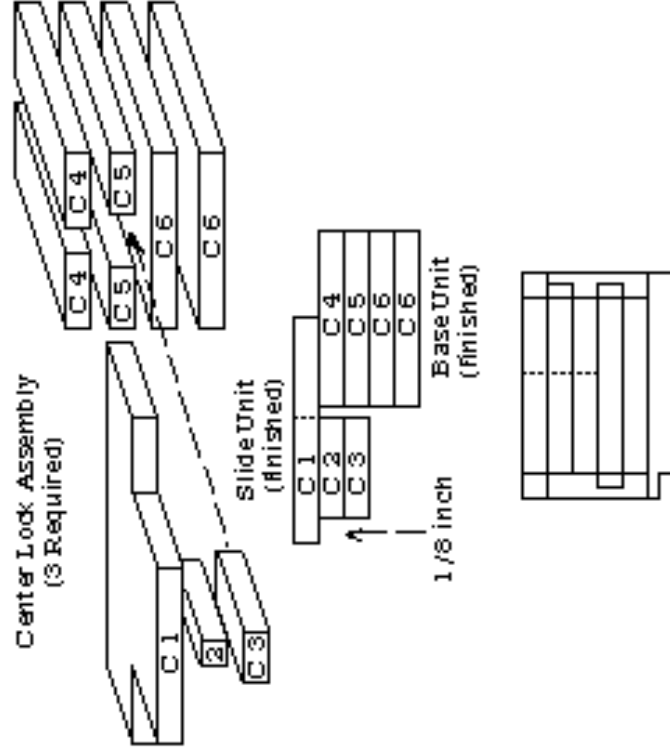

Left Side End Lock Assembly
(3 required)

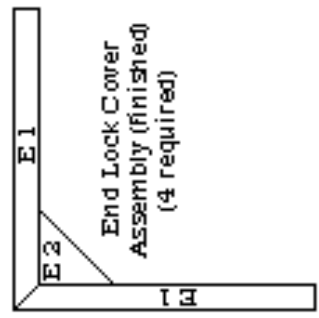
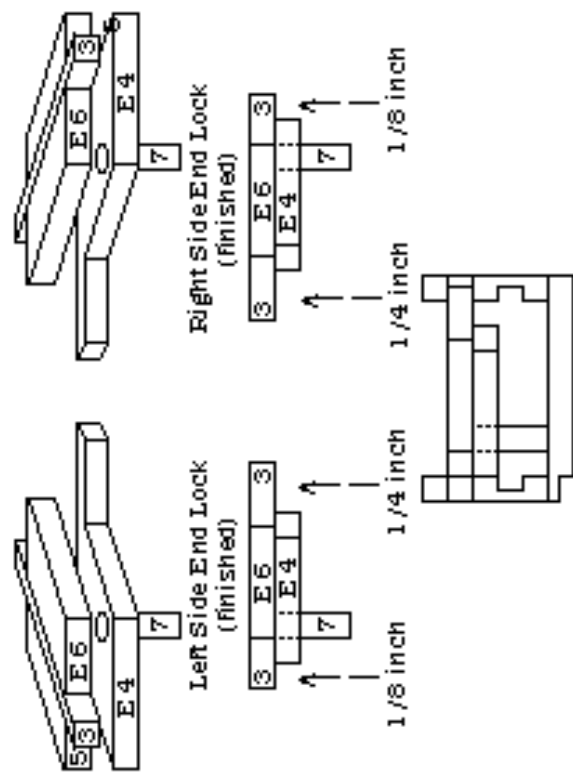

Main Lock Assembly

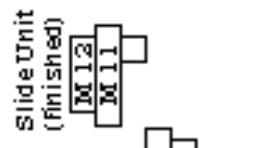
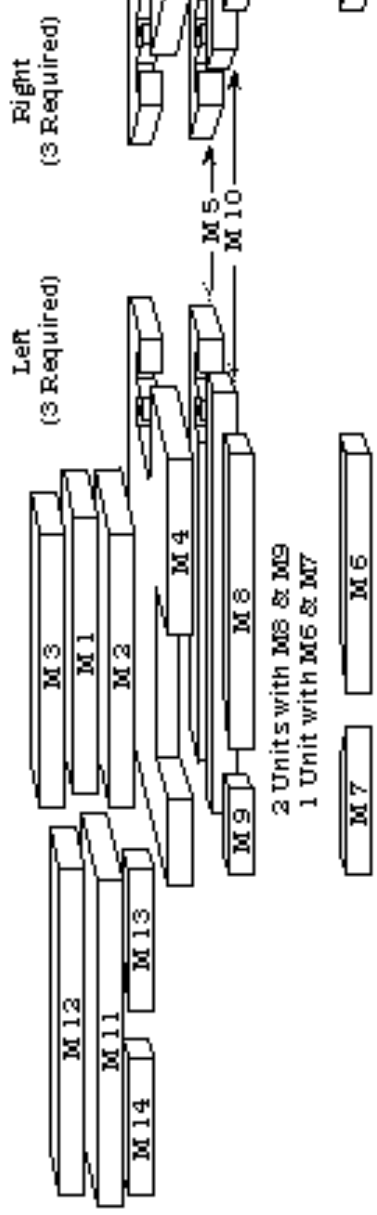

2 Units with M6 & M9
1 Unit with M6 & M7

1 Unit with M8 & M9
2 Units with M6 & M7

1/8 inch from wall

1/16 inch for channel

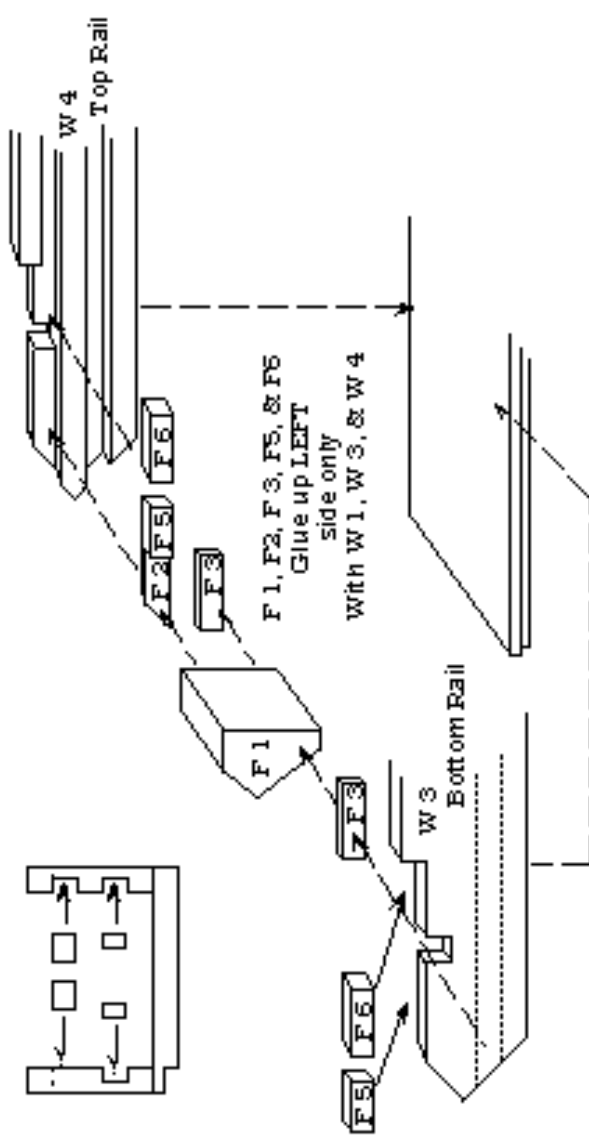

Walls for Locks
(3 Units)

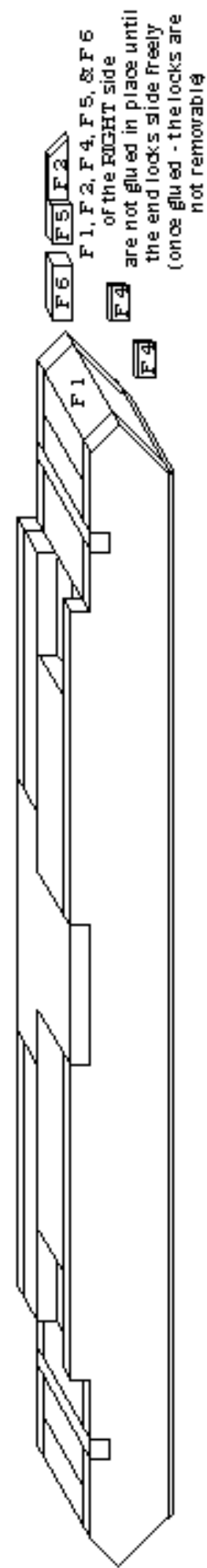

F1, F2, F4, F5, & F6
of the RIGHT side
are not glued in place until
the end locks slide freely
(once glued - the locks are
not removable)

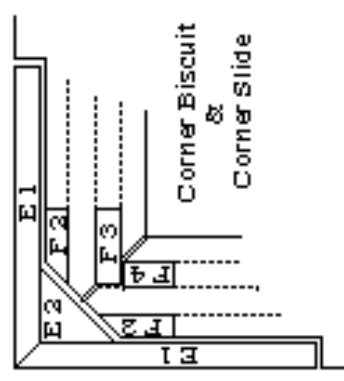

Use Locks and F1 for spacers when
gluing up the sides with their bases

**Hinge Assembly
and Hinge Wall
Details
(2 required)**

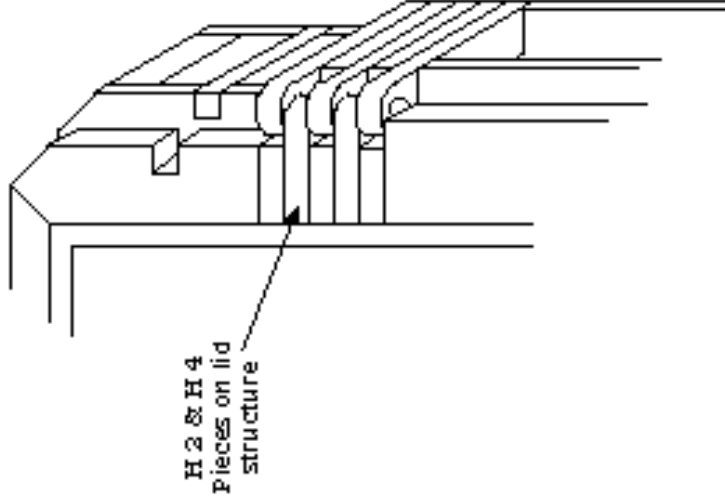
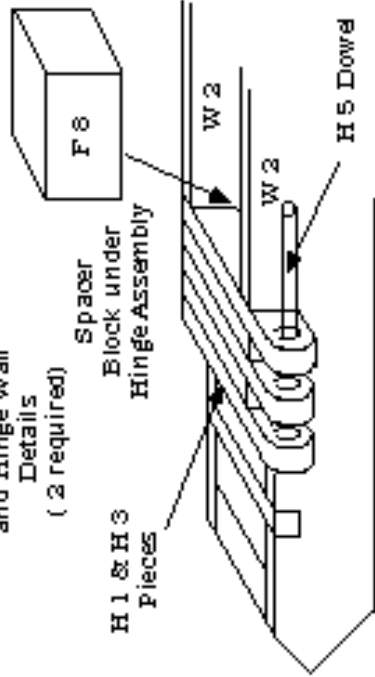

**Lock Pin Details
(6 required)**

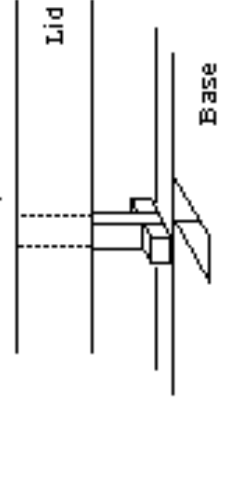

L2 is rounded to fit into
predrilled lid holes with
L1 cubesto each side.
The pin then slipsthrough
the base and into the main
locking assembly

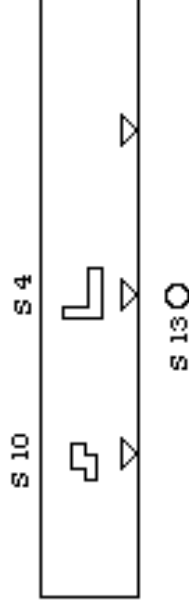
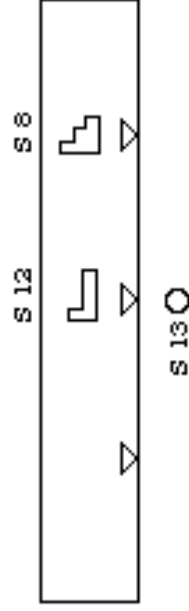
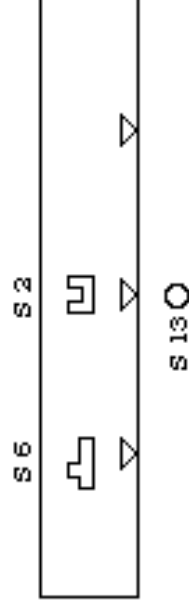
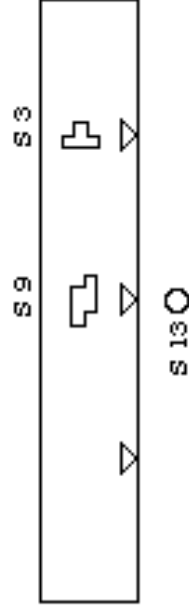
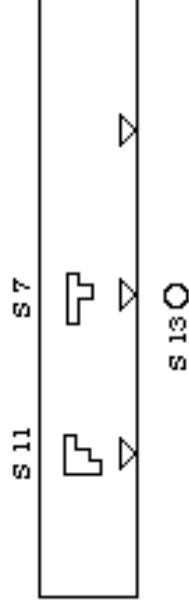
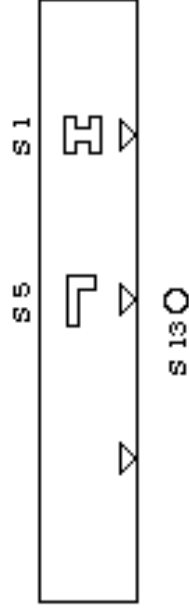

The above examples show the coding possibilities!
 Where you place the main center locks in each of the
 wall units will dictate where you place the
 CalmPlex piece icons.

These pieces may be
 set 'into' the wood or
 simply placed on top.

**The CalmPlex puzzle
 has 2 unique solutions
 for the 4x4 shape.**

**These are the 'Keys' to
 solving the 32 step
 puzzle box.**

They also form the 4x8 shape!
 ...and the 2x4x4...

At each 'OPEN' lock position is where you
 place the key piece icons of
 S5, S9 & S12 and S7, S2 & S4.

Also, you may cut the
 pieces into the actual
 tessellated pattern or
 simply show as 'glyphs'!

As noted on my web site
 in the GF-animation!

CalmPlex™ 32 Step Puzzle Box
 ©1998 Andrew Snowie & R. & A Media Inc.
 calmplex.com

1 inch = 1 inch
 31 Oct 1998

CalmPlex
 Pieces

Page
10 of 11

The final outcome of this project will be dictated by your degree of accuracy in cutting the various pieces and indeed your degree of 'perfection' with this task.

The actually assembly will take MANY hours since pieces must be 'tuned' to perfection.

Use of hardwoods such as birch are highly recommended.

Simple techniques with clamping such as using 'clothespins' and 'rubber bands' are also highly recommended as is the sometimes laborious task of simply 'holding' the piece until the glue sets.

I have found that soap flakes work better as a 'sealant' and a lubricant for the glides better than the use of common wax.

Surgical syringes filled with glue are the best application method since any 'spill-over' needs to be wiped clean if you plan on applying some final stains or varnishes. Wiping that excess glue off with water will have dramatic effects with these small wood pieces!

'Emery board' sandpaper works great! So does a 1/8 inch square file!

Assemble all locks first!

These are used as 'spacers' for the wall assembly.

Note the 'Right'/'Left' orientation of the locks.

Note the orientation of the 'base' to allow for the plywood cover.

When using the locks and spacers in assembly of the walls be VERY careful with the glue!

DO NOT glue the spacers into the channels until you are sure that the locks can slide freely.

Ensuring that the locks slide freely is the most critical step!

THEN ensure you 'soap' (or wax if you prefer) all movable parts.

When completed, there are many options for 'filling' all the gaps. These instructions encompass only the detailed workings of the box. The best all-round solution would be the traditional use of marquetry for all those finer details.

R&A Media Inc. assumes no responsibility for any errors or omissions. These drawings are intended as a guide only.

CalmPlex™ 32 Step Puzzle Box
©1998 Andrew Snowie & R. & A Media Inc.
calmplex.com

31 Oct 1998

General
Information

Page
11 of 11