



## Materials for the House

Here is the list of materials you will need to construct the basic house then to cover it with roofing and siding. The specialty materials needed for the door and windows are given along with the 'how-to-build instructions' for those details.

- ROOF, WALLS** ..... 1 - 4 x 8' sheet of 1/4" A-C plywood
- FLOORS** ..... 1 - 4 x 4' sheet of 3/8" A-C plywood
- TRIM A**..... 22 strips 1/16 x 3/8 x 24" or 11 pieces 3/8 x 3/8 x 22" corner molding (available from home centers and dollhouse stores.)
- B** ..... 6 strips 3/16 x 1/4 x 24"
- C** ..... 2 strips 1/16 x 1 1/2 x 24"
- D** ..... 1-12" piece of fluted 1 1/4" molding (or use router and bead cutter to make your own ornamental fascia trim)
- SIDING** ..... 70-1/16 x 1/2 x 24" strips of balsa or bass wood. Or sheets of siding-1/16 x 3 1/2 x 22"- are available at dollhouse suppliers ). They come in packages of 10 sheets. You will need two packages.
- SHINGLE** ..... Can be made from tongue depressors or 1/8" thick strips of pine. Or they can be purchased from dollhouse suppliers. A bag of 100 shingles covers 76 sq. inches. Five to six bags needed.

## Miscellaneous Supplies Needed

- Carpenter's Wood Glue
- Contact Cement
- Carpenter's Wood Filler
- Spray Paint-1 can each of Ruddy Brown Primer and two or three colors of your choice for house, trim, and roof
- 120-grit sandpaper (closed coat)
- Masking tape
- 1 " brads

## Tools You Will Need

- 10 or 13 oz hammer
- Brad pusher
- Circular and/or sabre saws Or Crosscut and keyhole saws
- Nail set
- Pad sander (or wooden block)
- Sharp Knife
- Putty knife
- Ruler

# 1. Cutting

## GENERAL INFORMATION

Start by laying out full-size drawings of the major parts for walls, floor and roof on the appropriate plywood sheets. If, for some reason, a variation in measurement occurs, make adjustments as required.

Door and window openings are sized to fit the make-your-own door and windows directions given later. If you want to use ready-made door and windows, check their dimensions carefully before cuffing openings in the plywood.

## FLOORS

Using a clamped straight edge and circular saw, cut three 13" wide x 48" long panels from the sheet of 3/8" plywood. (Note: cut the plywood with its good side down when using either circular or sabre saw.) Next, on one of the panels draw the basic floor plan, following the layout shown in Illus. 1. When satisfied that the drawing is correct, place this panel over the other two, keeping two edges of all three perfectly aligned. Use either clamps or small nails (out of the cutting path) to keep the three panels rigidly fixed while you cut all three at one time.

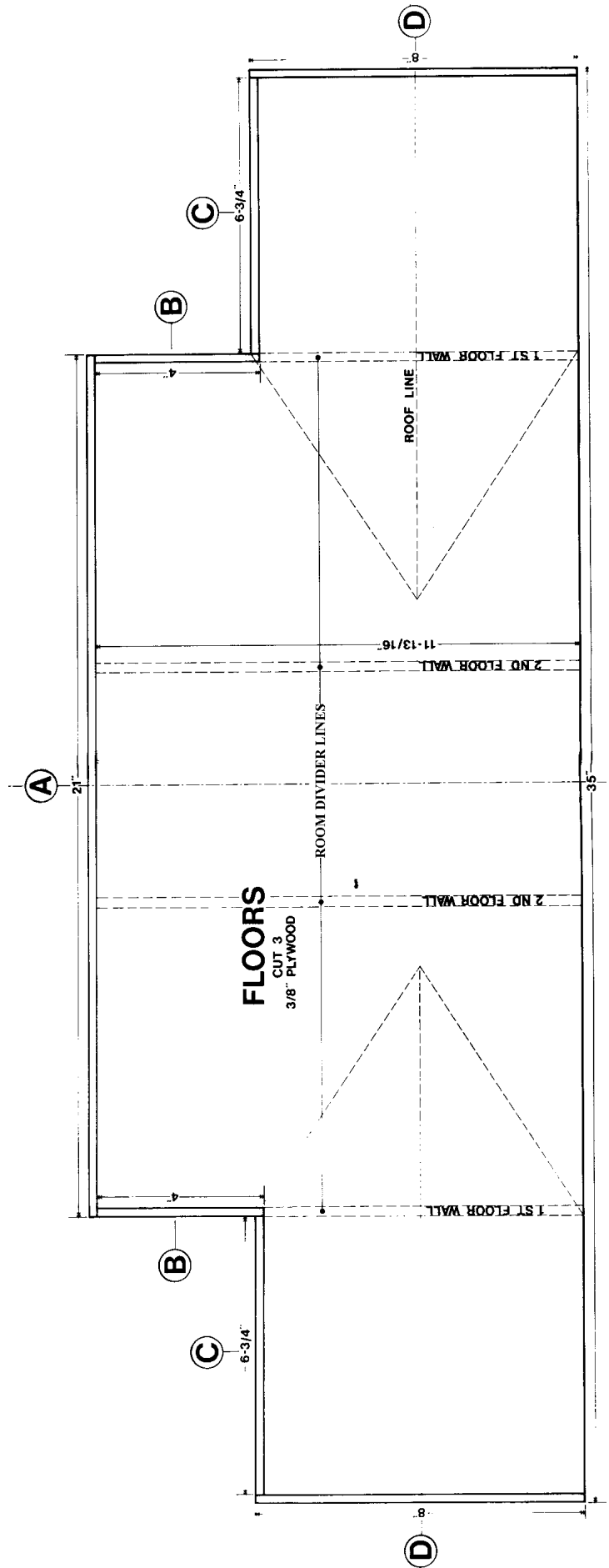

### 3. Exterior Walls-Front

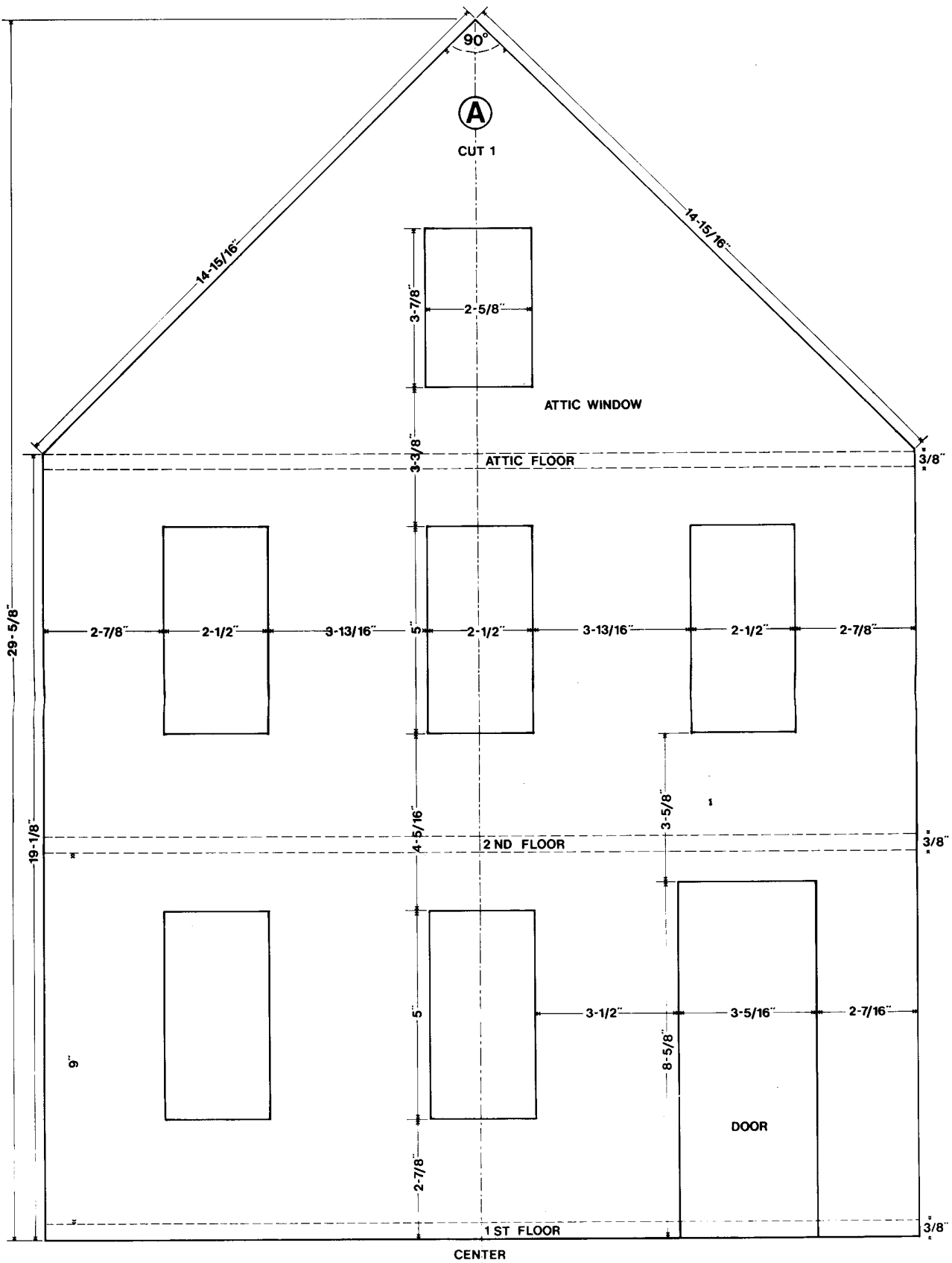

(Illus. II)

### 3. Exterior Walls-Sides

Cut following from 1/4" plywood:

Two pieces for side walls B abutting front wall A (Illus. 111)

Two pieces for wing walls C (Illus. IV)

Two pieces for wing walls D (Illus. V). There are cutout lines indicated for making the lower window openings to fit either bay or conventional window.

After filling and sanding (as described below), carefully locate and mark the points where the second and attic floors will be fastened to various exterior wall pieces.

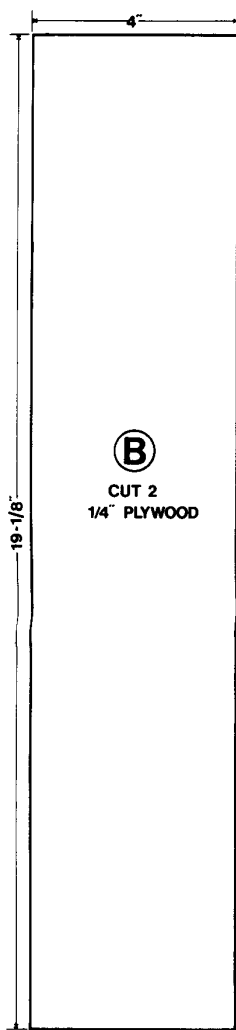

(Illus. III)

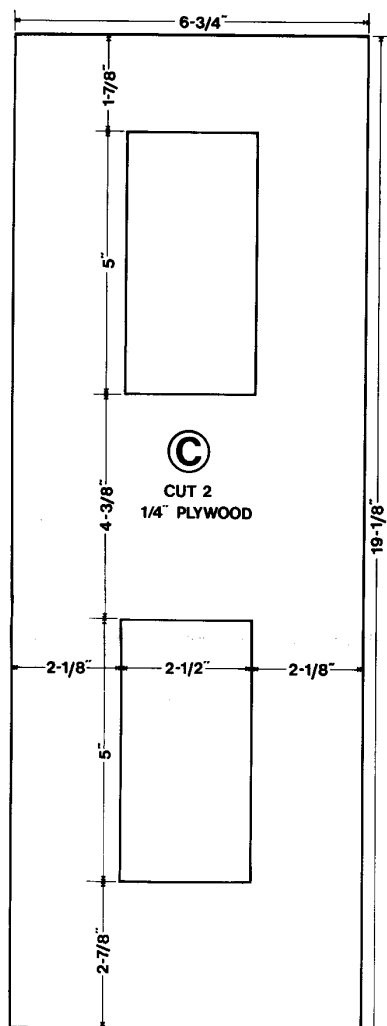

(Illus. IV)

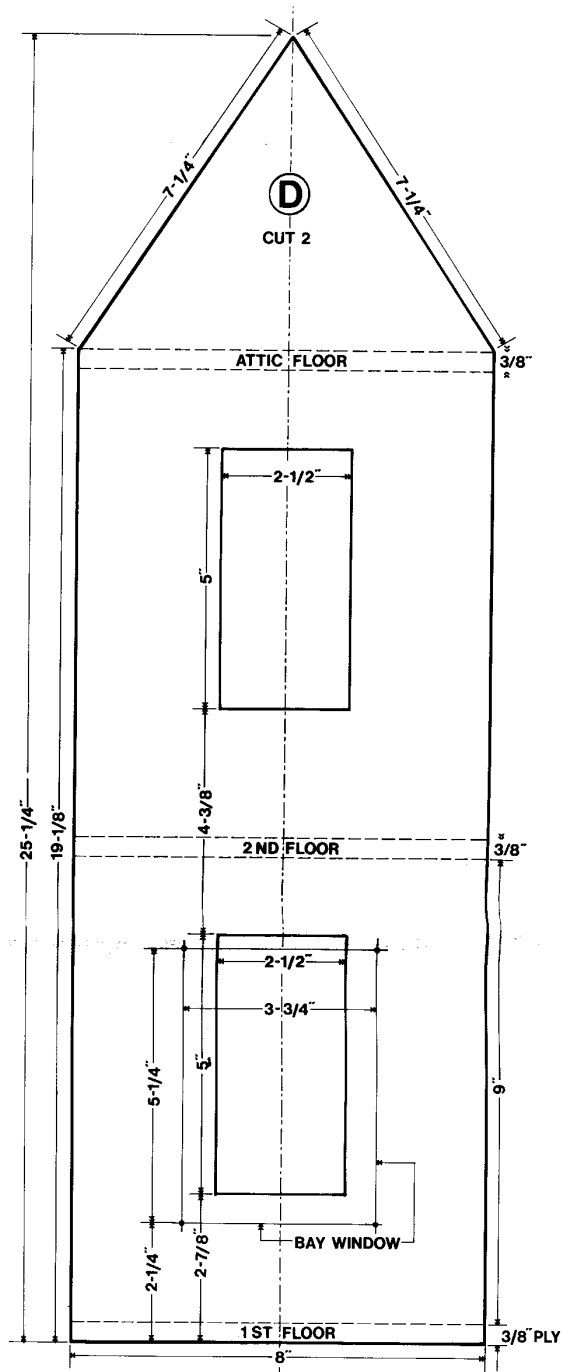

CENTER  
(Illus. V)

## 4. Exterior Walls-Sides

Cut the 4 pieces from 1/4" plywood as shown in Illus. VI.

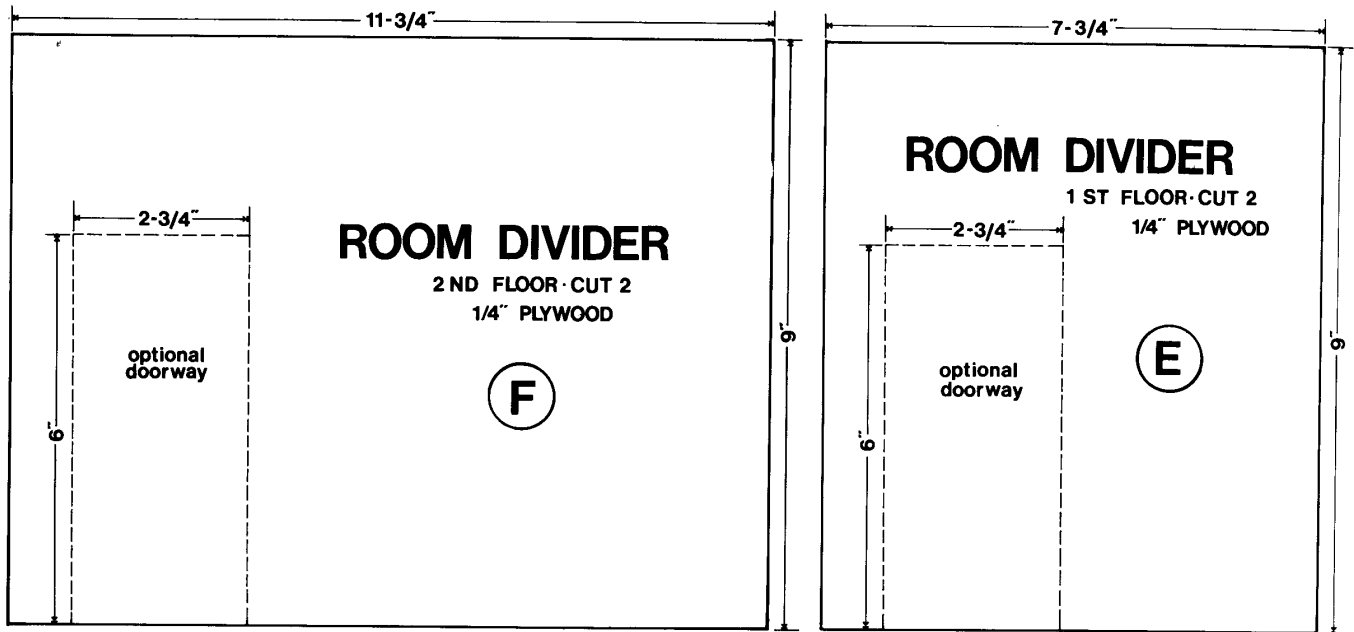

(Illus. VI)

## 5. Roof

Cut the 6 pieces from 1/4" plywood as shown in Illus. VII.

**IMPORTANT** After all plywood parts are cut-and before joining them-check all edges for voids and all surface areas for scratches or dents. Using a putty knife, fill in all imperfections with wood filler. Allow filler to dry thoroughly before sanding the plywood parts.

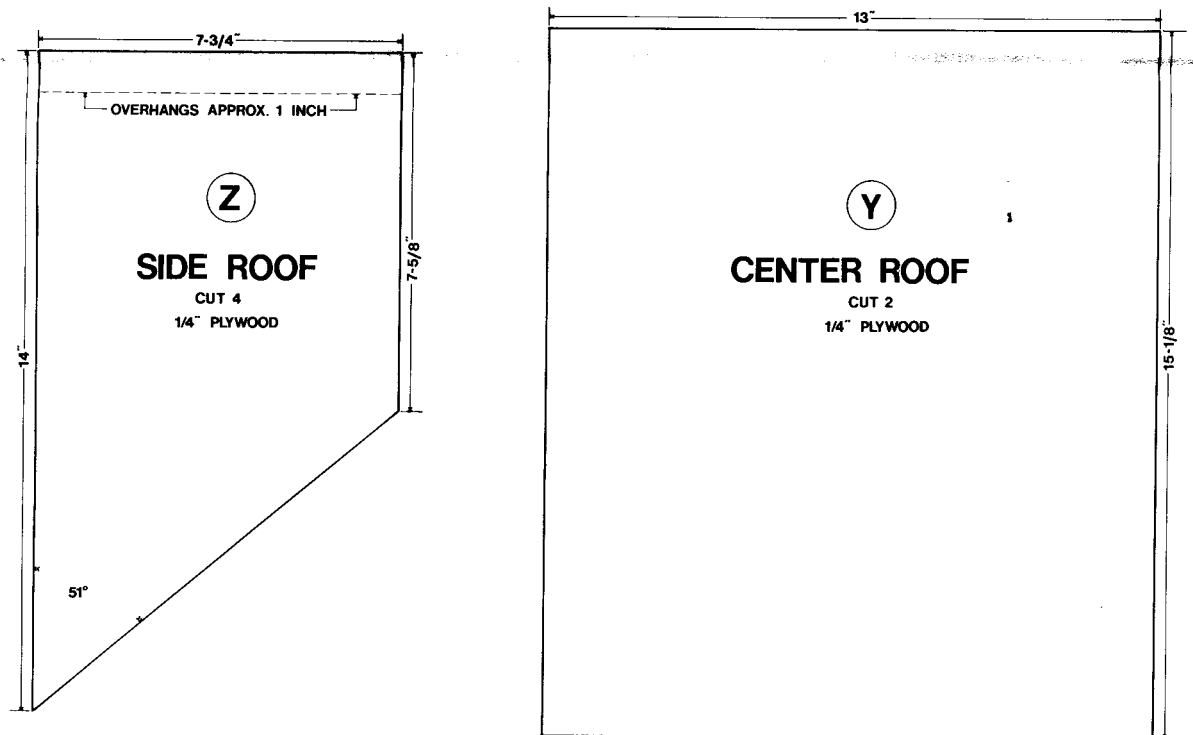

(Illus. VII)

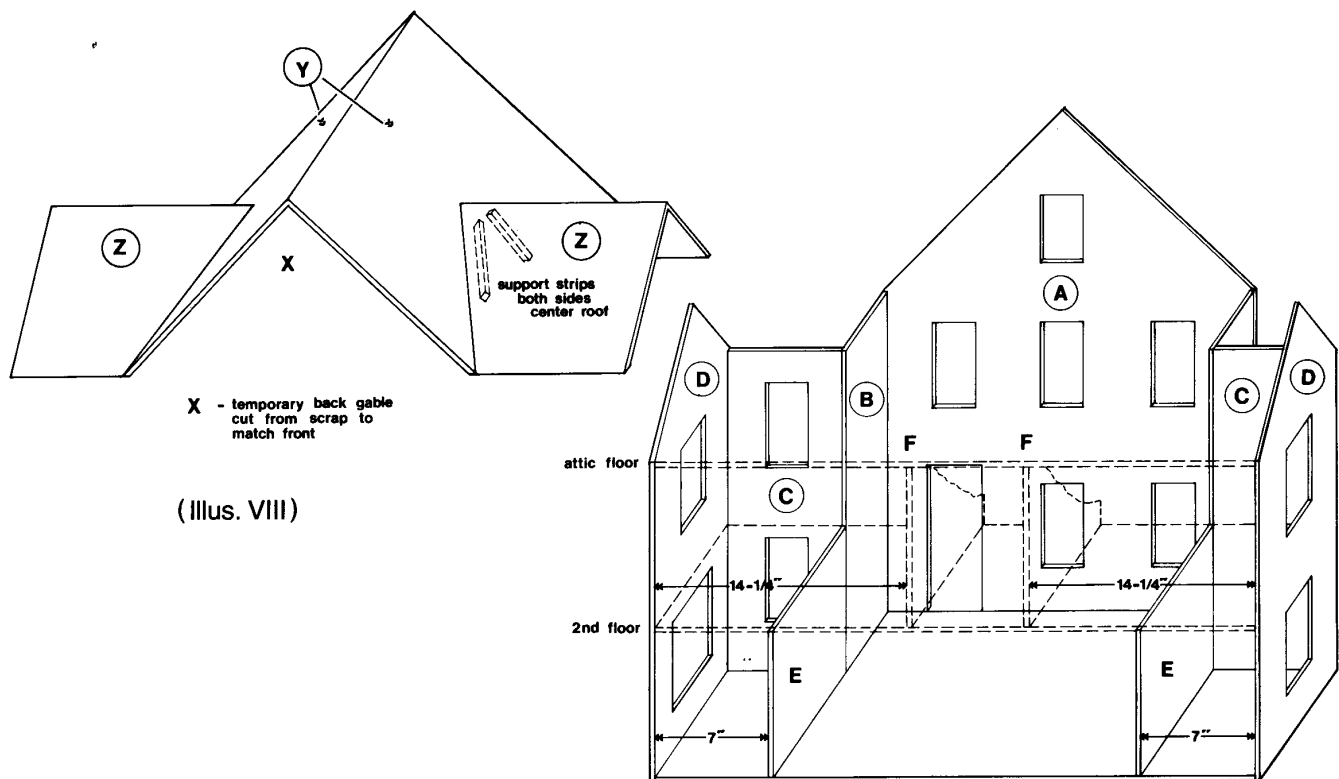

## 6. Assembling

### GENERAL TIPS

Sand all cut pieces of plywood smooth before proceeding with assembly. Since plywood comes from the manufacturer already sanded fairly smooth, use 120-grit abrasive paper on a pad sander or wrapped around small block of wood to prevent rounding of edges, as all pieces are butt-joined. Dust off.

Use 111 brads and carpenter's wood glue for all joinery. This glue gives a good span of working time but, once you have joined the parts, the dollhouse should be allowed to dry undisturbed for at least 12 hours.

After fastening with brads, immediately, remove any glue squeeze-out from joints, using a water dampened rag. If you miss any such spots, hardened glue can be removed later with a sharp chisel.

### PROFESSIONAL TIP

Apply wood glue sparingly. A little goes a long way. More doesn't make it stronger. Apply the glue to mating surfaces and spread it evenly with a wooden spatula or brush. If you leave the glue exposed to the air for about 30 seconds, the parts will not slide about when you make contact and drive the brads.

### ASSEMBLING WALLS AND FLOORS

Start by attaching wall sections B to the first floor. Apply glue to mating surfaces and use brads through wall and into floor. Add front wall A, then sections C and D.

Install and secure interior walls E to the first floor and to edges of walls B, applying glue to mating surfaces.

Install interior walls F on top of second floor where marked in plans, using glue and brads. Insert preassembled floor into place and draw thin lines along walls where floor and partitions will meet walls. Take out and draw thin bead of glue touching the lines. Apply thin bead to edge of floor and partitions and install floor into house.

Insert attic floor and mark where floor hits exterior walls. Draw bead of glue along lines and mating edges of floor and install.

**NOTE:** While floors are secured by brads through walls and into the edges of the plywood, glue must be used to obtain a permanent joint.

## **ROOF**

The roof is attached starting with the center sections (Y). To give rigidity during assembly, you might want to cut a temporary back gable (X) which will match the front gable of side A. Assemble roof sections (Y) to house at front, using glue and brads. Insert temporary back gable (X) and hold in place with partially-driven brads only. To roof wings, hold one Z section in place at a time. As each is placed in what will be final position, mark its underside on mating roof Y. Make matchmarks on both for later joining. Repeat for all four Z panels. Place Z parts aside for the moment and install four support strips, using the just-drawn guidelines. (See Illus. VIII.) When strips are permanently secured, roof parts Z can go on. Remove the temporary gable after all assembly is completed.

## **7. The Finishing Touches**

### **SIDING**

The house is designed so that it can be finished with or without siding as you prefer. You can make your own from 1/16 x 1/2 x 24" strips of balsa wood or you can purchase them from a high-end craft store.

The strips of siding are glued to the house's exterior walls with contact cement. Apply the cement to both surfaces, wait approximately 20 minutes and test cement for dryness by touching with a clean piece of brown paper. When glue doesn't adhere to paper the parts can be permanently pressed together. Start at bottom. Each succeeding strip should overlap the preceding strip by about 1/8".

### **ROOF SHINGLES**

The roof shingles on the house are available by the bagful. Each bag of 100 shingles covers approximately 76 square inches. If you prefer, you can make your own shingles by cutting 1/4 x 3/4" pieces from 1/8" lattice. Or, cut them from tongue depressors available at drugstores. Glue the shingles in place on the roof, using the pattern shown in the drawing.

### **TRIM**

If trim is to be contrasting color from house, paint it before installing on already painted house. (See "Painting.") Using wood glue, install corner mold A on corners of house over siding and along the roof joints over shingles. If you cannot buy corner mold, a pair of 1/16 x 3/8" strips at each corner can be used to create the same effect.

Install trim B (3/16 x 1/4" strips) along the gable (rake) of the roof. Glue fascia trim C (1/16 x 1 1/2" strips) flat against the house and flush with the roof overhang. The molding ends should be mitered. Notice the ornamental moldings along the rake fascia trim on the gable ends of the house. These are simply 1/2" cut from a strip of shaped or fluted molding and glued in place under the roof overhang as indicated on the drawing.



# 8. Windows Shutters, and Door

If you plan to purchase ready-made windows and door, check parts measurements before cutting openings in the plywood. See "Sources" for information on these components.

## BAY WINDOW

Use chart below for quantity and sizes of pieces needed to make a bay window. Assemble as shown in Illus. X, using carpenter's wood Glue.

### Quantity and Sizes-Bay Window Parts

- 3-a 5 1/4" x 115/16" clear plastic to back each section of bay window.
- 3-b
- 1-c
- 2-d SEE DIAGRAM FOR SIZES
- 3-e
- 3-f
- 6-g 17/16", wide 1/4"1, high 1/8" thick
- 6-h 1/4" wide 5 1/4" high 1/8", thick
- 3-i 17/16" wide 1/8" square
- 6-j 3/4" high 1/8", square

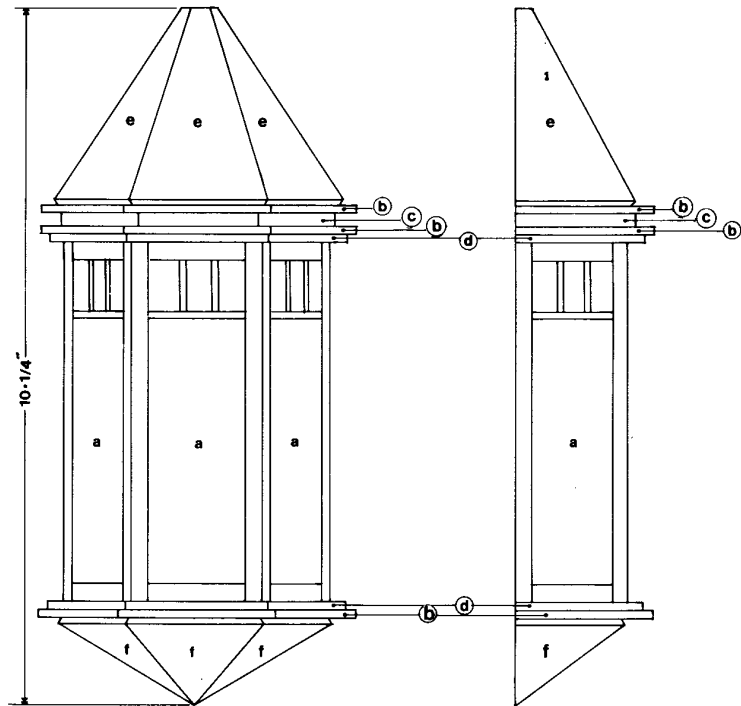
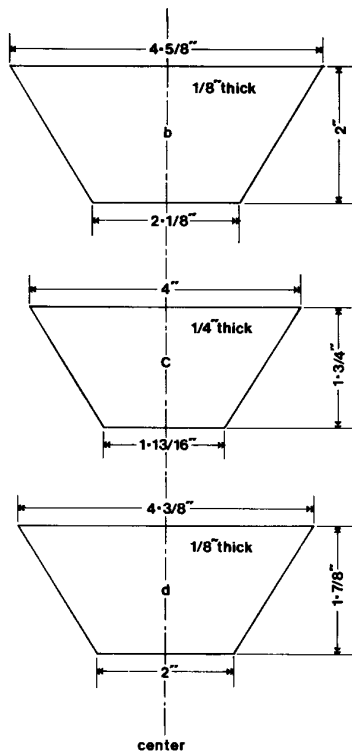
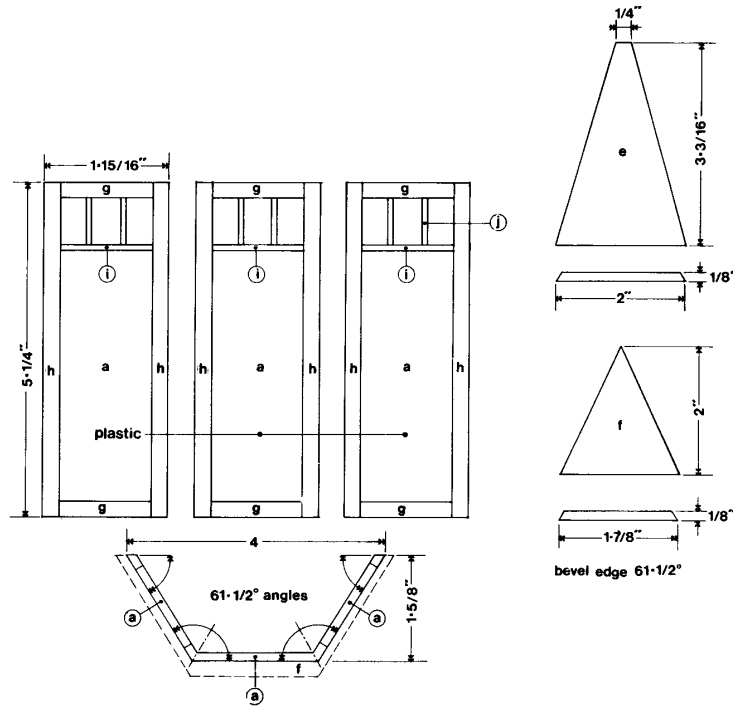

(Illus. X)

BAY WINDOW DETAILS

## 9. Other Windows and Shutters

Use chart below for cuffing the parts for the 13 windows (12 regular and 1 attic). Assemble with glue as shown in Illus. XI.

### Quantity and Sizes for Windows and Shutters

12-a	4" wide	1/2" deep	1/8" thick
12-b	3 1/2" wide	3/8" square	
48-c	3 1/4" wide	1/4" square	
24-d	2 7/8" wide	1/8" square	
48-e	4 3/4" high	3/8" wide	1/8" thick
12-f	2 1/16" wide	1/8" square	
50-g	1 1/4" wide	3/16" high	1/16" thick
48-h	4 1/4" high	3/16" wide	1/16" thick
24-i	4 5/8" high	1 1/4" wide	1/16" thick
4-j	3 3/8" wide	3/8" high	1/8" thick
4-k	3 5/8" high	3/8" wide	1/8" thick
4-l	3" high	3/16" wide	1/16" thick
2-m	3 3/8" high	1 1/4" wide	1/16" thick

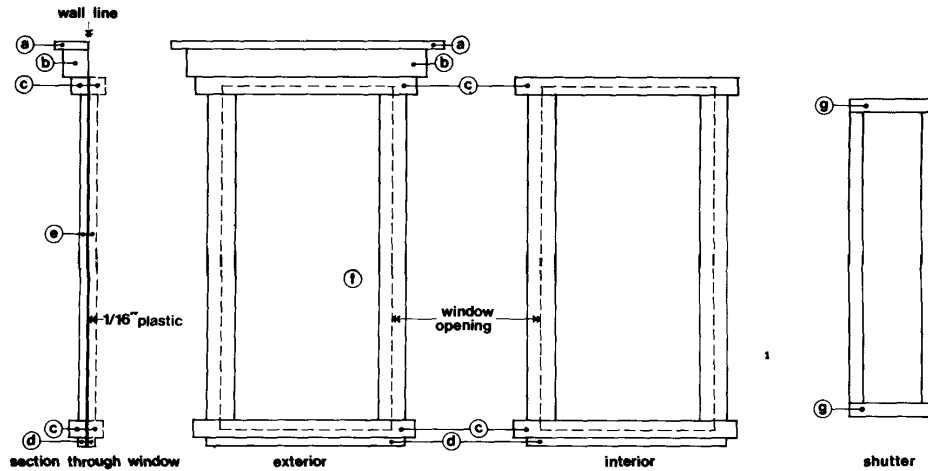

WINDOW DETAILS

(Illus. XI)

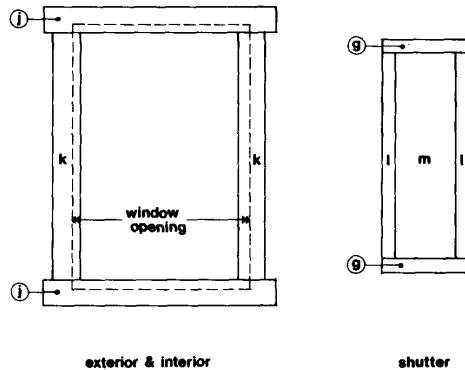

ATTIC WINDOW

# 10. Door

Use chart below for cuffing pieces for door and frame.  
Assemble with glue as shown in Illus. XII.

### Quantity and Sizes for Door

2-a	5/8" wide	4 3/8" long	1/8" thick
2-b	1/2" wide	13/16" high	9/16" thick
1-c	3/4" wide	4 5/8" long	1/8" thick
2-d	1/2" wide	11/4" high	9/16" thick
2-e	1/2" wide	5 9/16" high	1/8" thick
2-f	5/8" wide	3/4" high	1/4" thick
1-g	3 1/8" wide	3/8" high	1/8" thick
2-h	115/16" wide	1" deep 1/4" thick	
2-hh	1 1/2" wide	1" deep 1/4" thick	
2-i	13/16" wide	1" deep 1/4" thick	
2-j	13/8" wide	1" deep 1/4" thick	
1-k	2 15/16" wide	3/16" high	1/8" thick
1-l	2 15/16" wide	1/2" high	1/8" thick
2-m	3/16" wide	8 5/8" high	1/8" thick
4-n	1 13/16" wide	1/2" high	3/32" thick
11-o	1/2" wide	3/4" high	3/32" thick
2-p	1/2" wide	2" high	3/32" thick
2-q	1/2" wide	6 7/8" high	3/32" thick
1-r	2 15/16" wide	3/8" high	1/8" thick
1-s	2 7/8" wide	6 7/8" high	1/4" thick

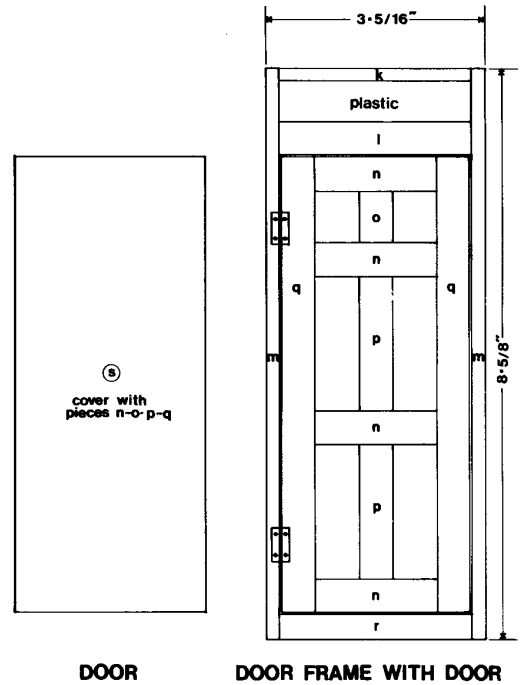

(Illus. XII)

# 11. Painting

Before painting, give the house a final, thorough dusting (a vacuum cleaner is best), then wipe all parts with a tack cloth to remove every bit of dust.

If room areas are to be stained, mask them before applying primer.

If you plan on painting trim (corner molding, windows, shutters, etc.) a different color from the main part of the house, paint the house before installing the pre-painted trim. Spray entire house with Ruddy Brown Primer and allow to dry overnight. Spray on color, using two very light coats; allow the first coat half an hour or so to dry before applying the second.

