

AKERS

Craftsman Tall Shelf Clock Number 1

Walt Akers
Twisted Oaks Studios

December 20, 2000

Directional Views of Clock

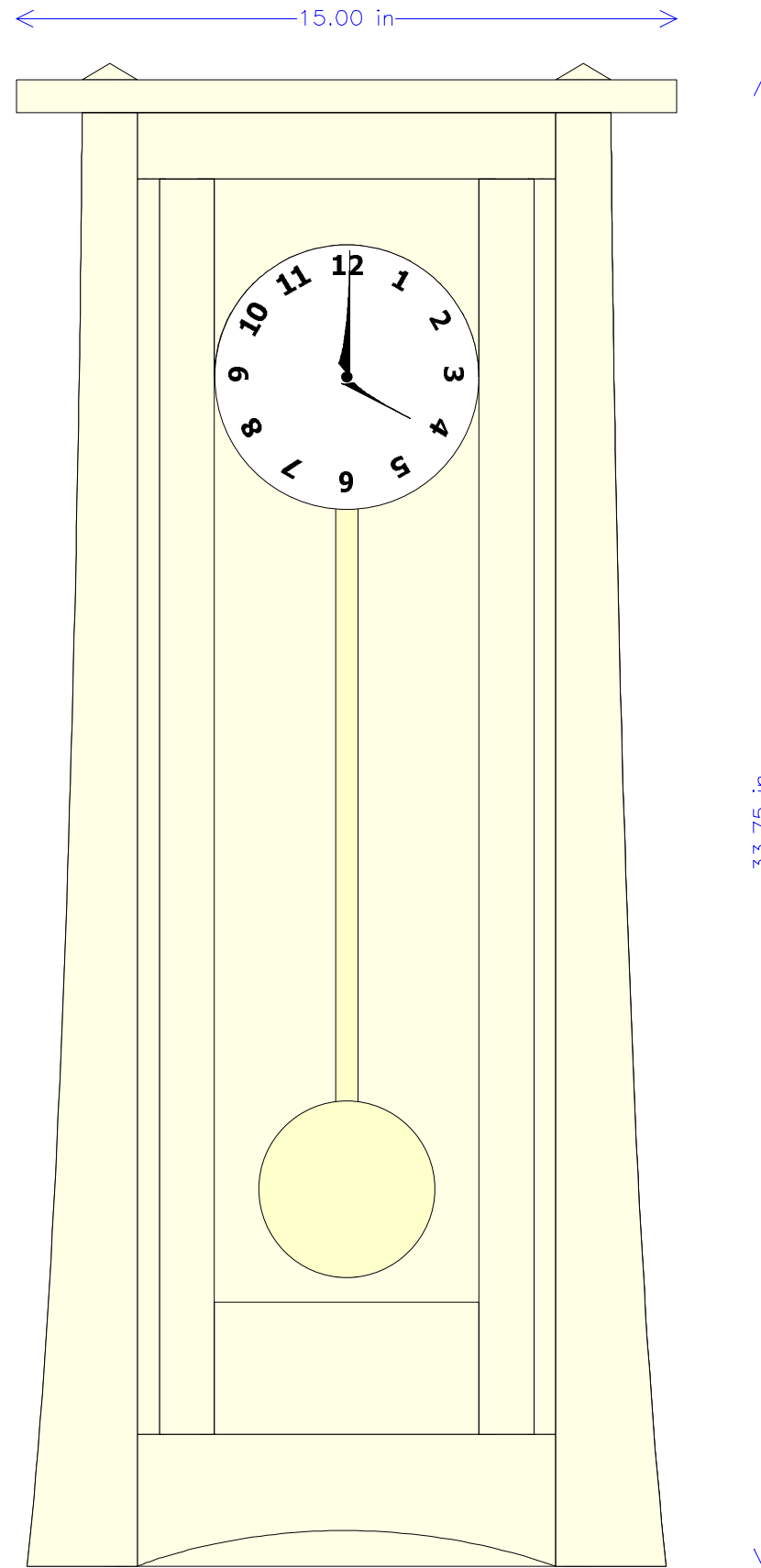

Front View

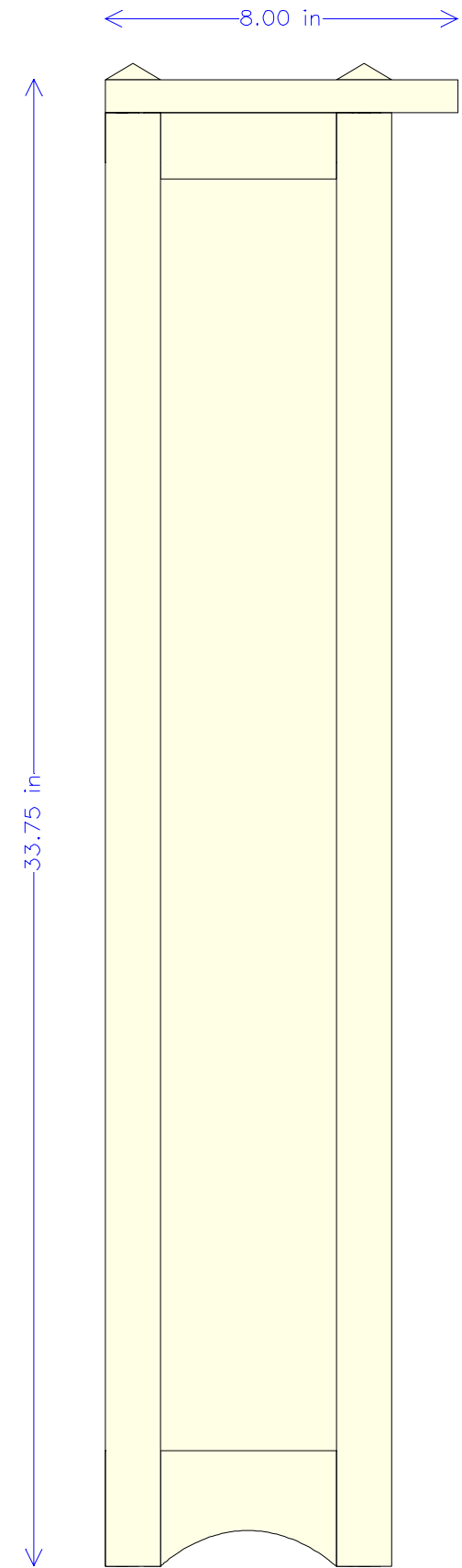

Side View

Top Side Stile (2 Each)

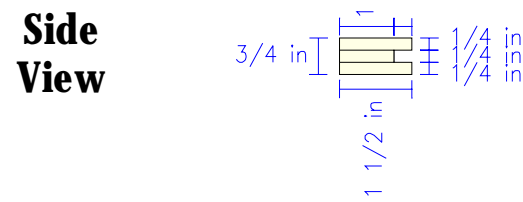
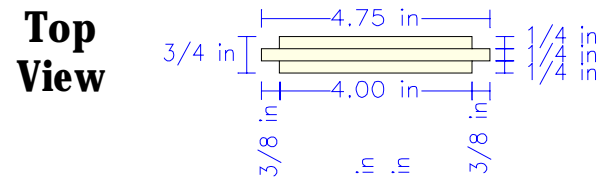
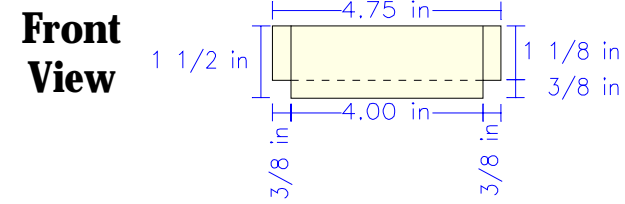

Top Rear Stile

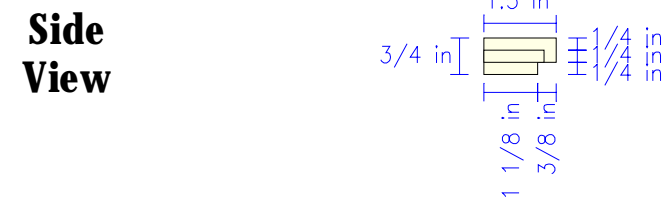
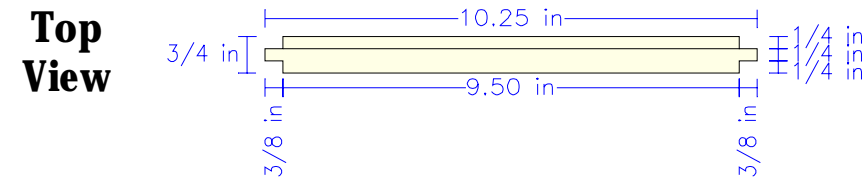
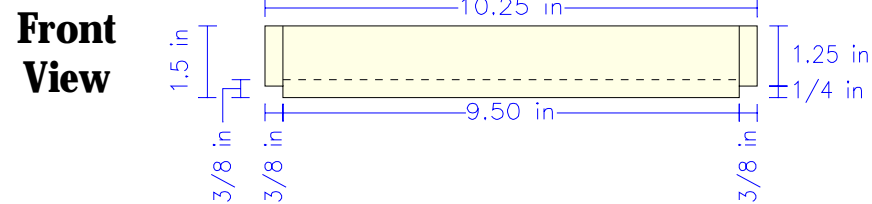

Top Front Stile

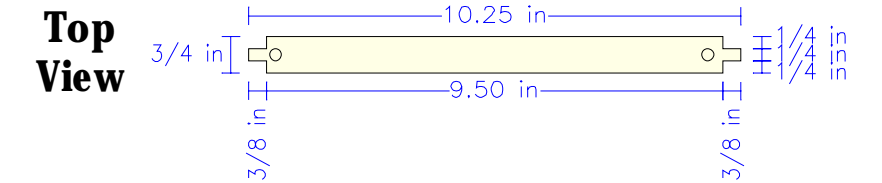
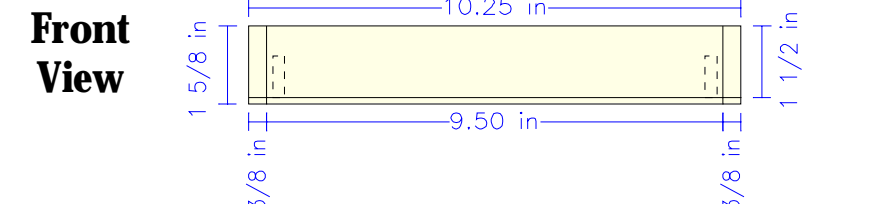

Bottom Side Stile (2 Each)

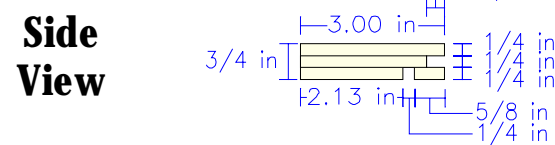
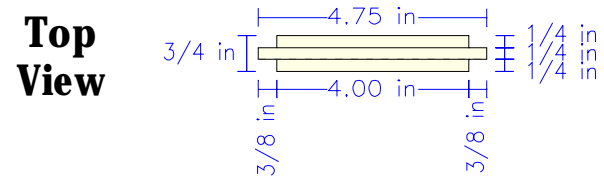
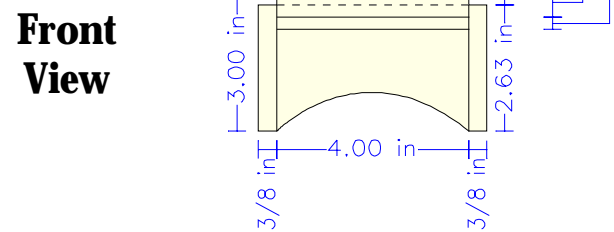

Bottom Rear Stile

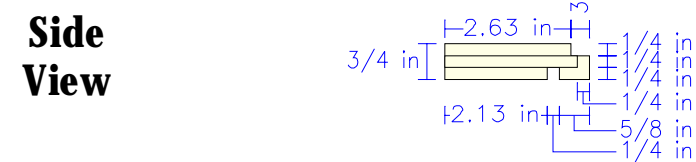
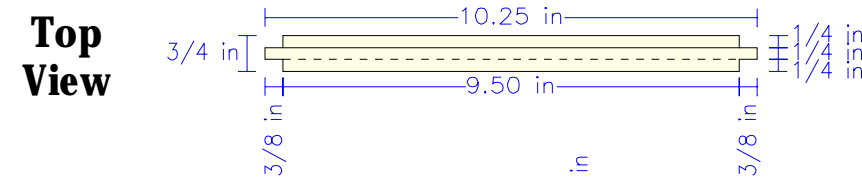
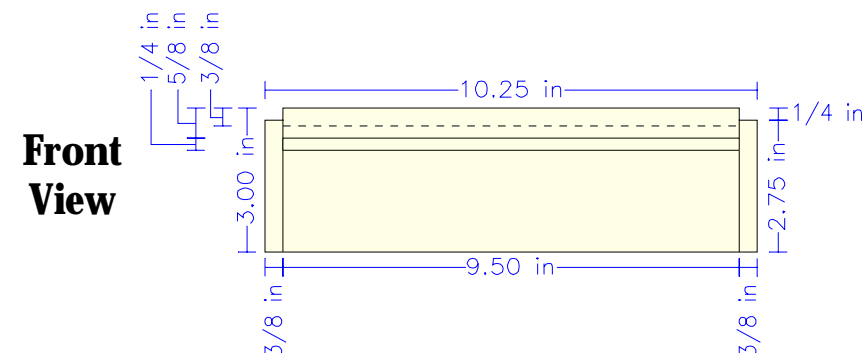

Bottom Front Stile

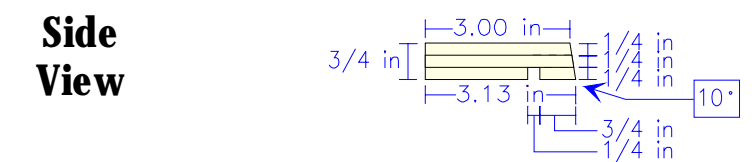
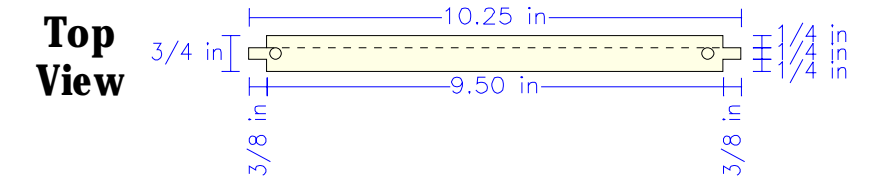
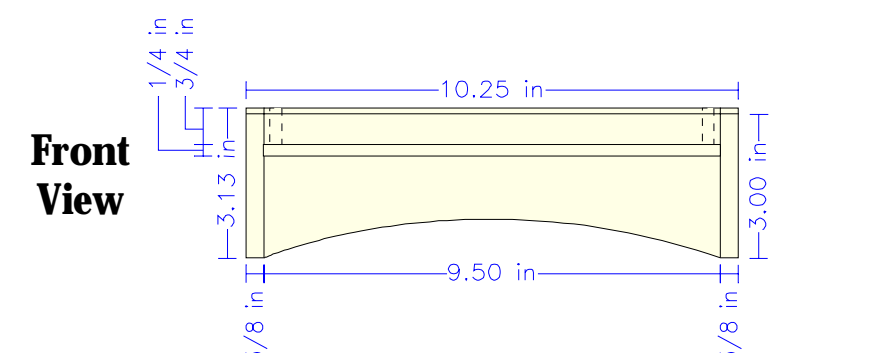

Top Door Stile

Front View

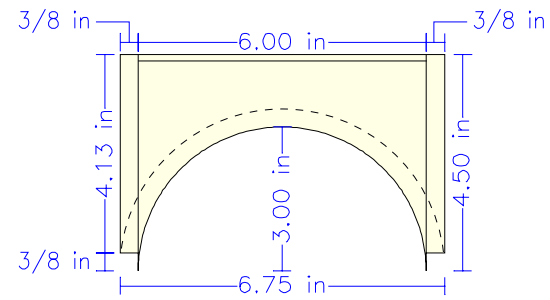

Top View

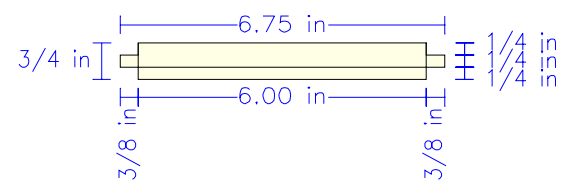

Side View

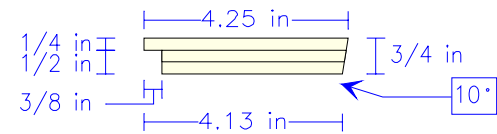

Side Panel (2 Each)

Front View

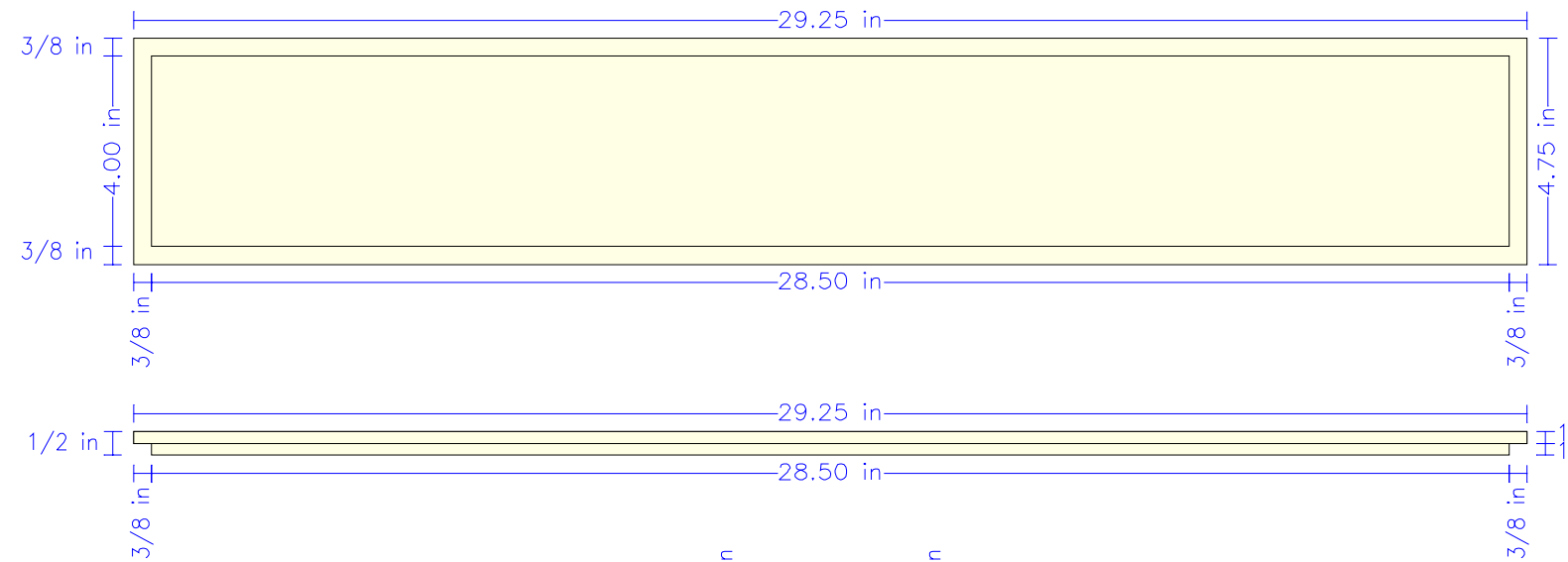

Side View

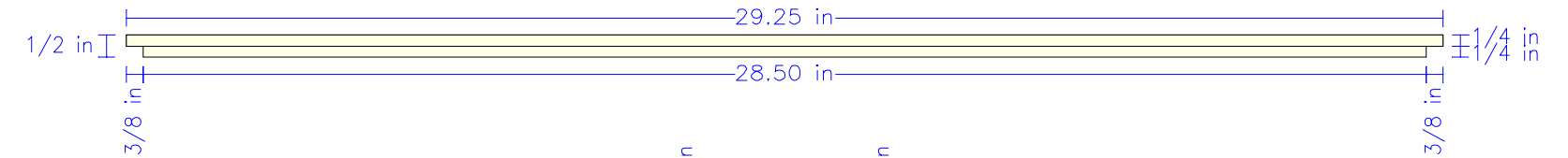

Top View

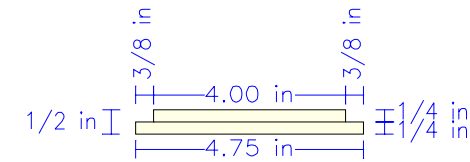

Bottom Door Stile

Front View

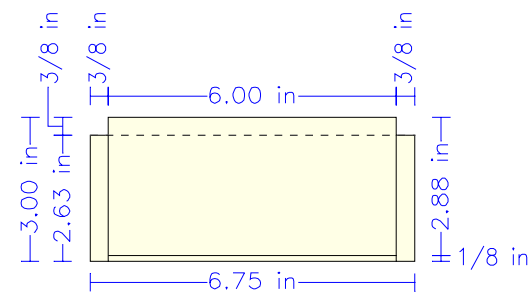

Top View

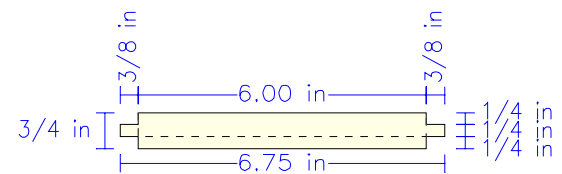

Side View

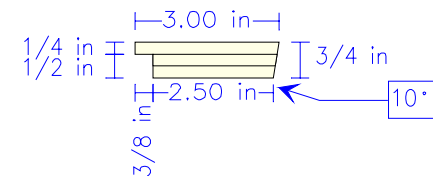

Door Rail (2 Each)

Front View

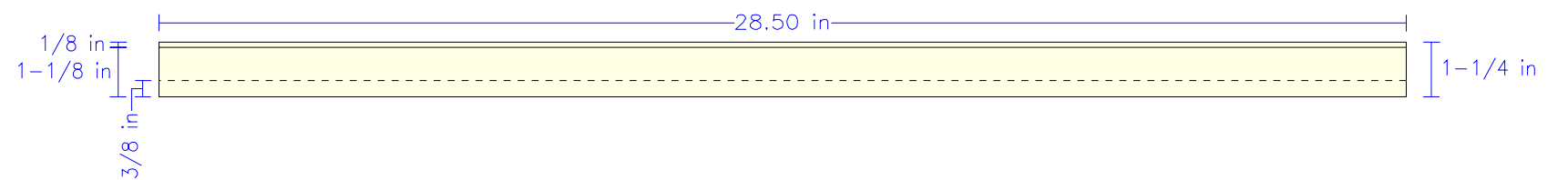

Side View

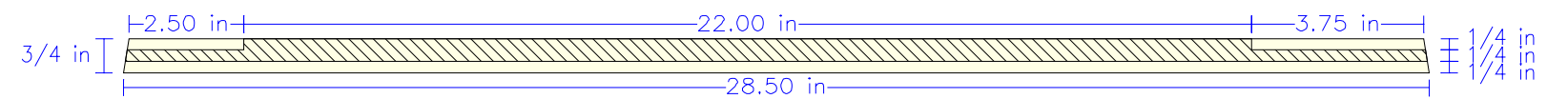

Top View

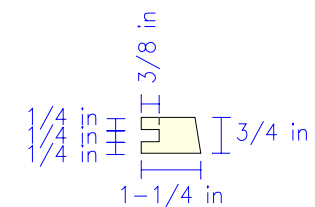

Bottom Panel

Top View

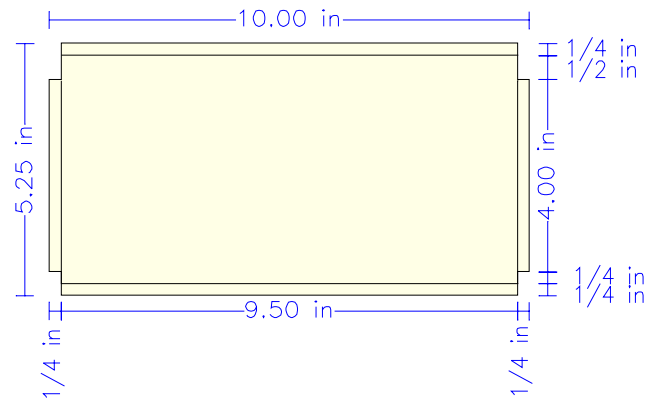

Front View

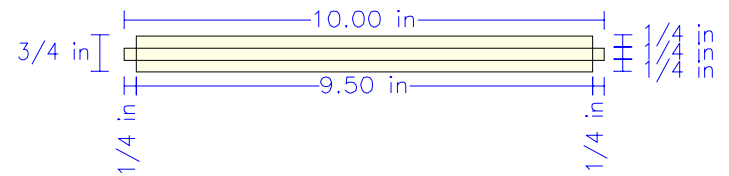

Side View

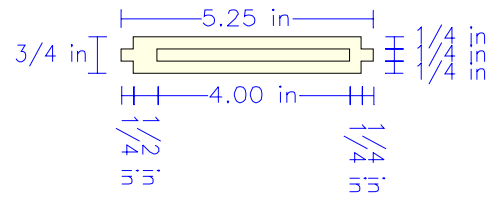

Clock Top

Top View

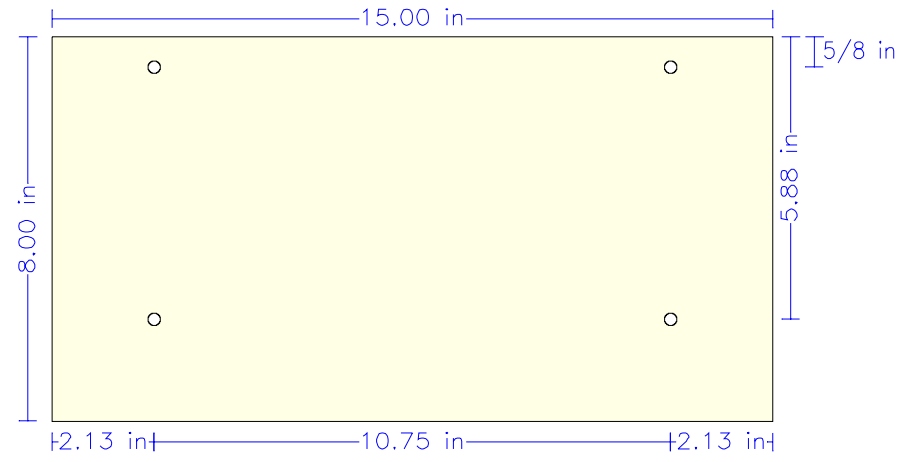

Front View

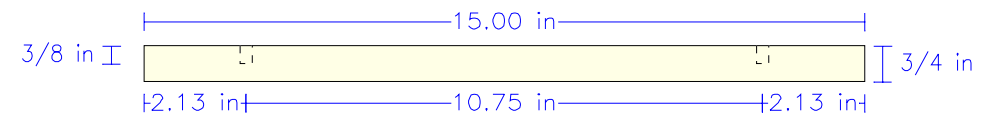

Side View

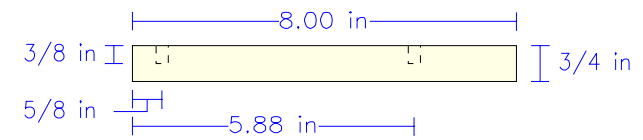

1/4 Inch Back Panel

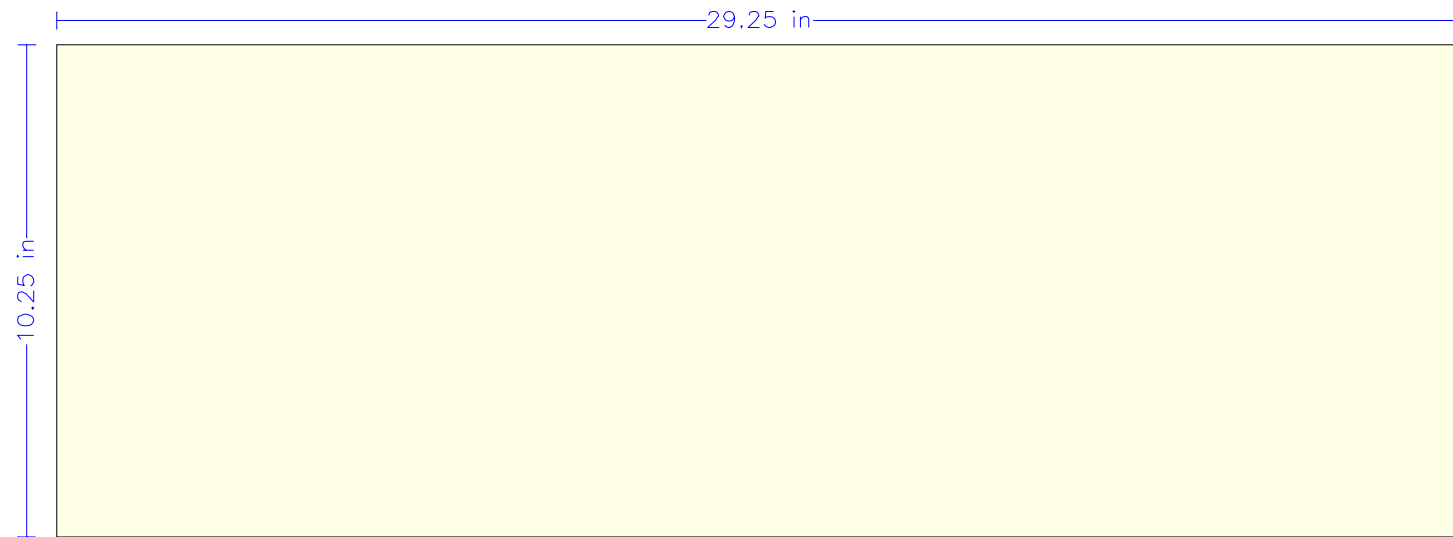

Finial (4 Each)

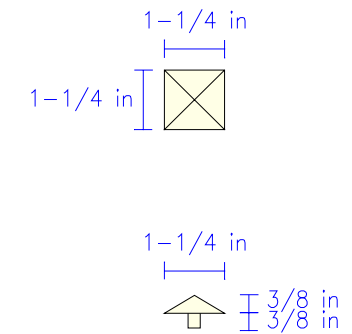

Front Rail (2 Each)

Front View

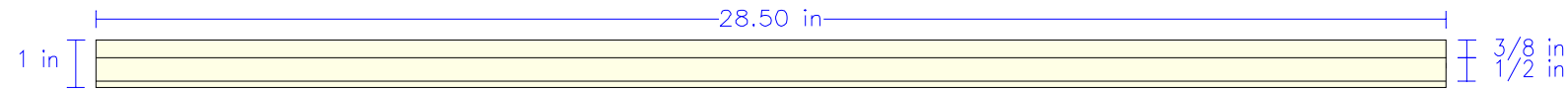

Side View

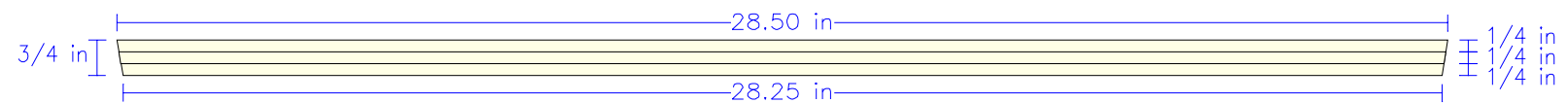

Top View

