

3 GREAT JIGS FOR PERFECT CLAMPING
NOW MORE **PROJECTS, TECHNIQUES, REVIEWS**

FEBRUARY 2002
ISSUE #126

Popular **Woodworking**

CLASH OF THE **TABLE SAWS**

- Who makes the **BEST MACHINE**
- Learn the **BEST TECHNIQUES**
- Build **SUPER-SMART**
OUTFEED TABLES

8 DO-OR-DIE
lessons in
wood movement

PLUS

- Shaker Candlestand
- Sliding Bench Deadman
- Rehandle your Chisels

**CANADA'S
MAG
RUFFMAN**

TV's first woman
of woodworking
builds projects
using off-the-rack
materials

www.popwood.com
\$4.99 U.S. \$7.99 CAN





Actor Dan Haggerty with Ben, Stars of "Grizzly Adams"

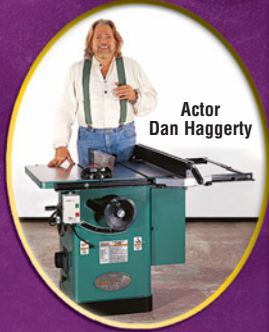

Actor Dan Haggerty

"I love dealing with Grizzly Industrial. They have excellent products and stand behind everything they sell."

Dan Haggerty



"Please, can we buy it, honey?"



Grizzly Industrial®

PURVEYORS OF FINE MACHINERY™ - SINCE 1983

MODEL G8794 12½" PORTABLE PLANER

- 2 H.P., 110V MOTOR, 15 AMPS
- CUTTERHEAD SPEED: 8,540 R.P.M.
- FEED RATE: 25 F.P.M.
- NUMBER OF PUTS PER INCH: 57
- MIN. BOARD THICKNESS: ¾"
- MAX. CUTTING WIDTH: 12½"
- MAX. CUTTING HEIGHT: 6"
- MAX. CUTTING DEPTH: ⅛"
- APPROX. SHIPPING WEIGHT: 85 LBS.



ONLY \$289⁹⁵

\$30 SHIPPING ANYWHERE IN LOWER 48 STATES

FREE STAND
INCLUDED WITH G8794 PLANER
(700LB. CAPACITY)

MODEL G1021Z 15" PLANER W/ CABINET STAND

- 3 H.P., 220V, SINGLE-PHASE MOTOR
- PRECISION GROUND CAST IRON BED
- CUTTERHEAD SPEED: 5000 R.P.M.
- RATE OF FEED: 16 F.P.M. & 20 F.P.M.
- MAX. CUTTING WIDTH: 14½"
- MAX. CUTTING HEIGHT: 6½"
- MAX. CUTTING DEPTH: ⅛"
- NUMBER OF KNIVES: 3
- ALL BALL BEARING CONSTRUCTION
- APPROX. SHIPPING WEIGHT 540 LBS.



ONLY \$995⁰⁰

\$125 SHIPPING ANYWHERE IN LOWER 48 STATES

MODEL G1033 20" PLANER

- 3 H.P., 220V, SINGLE-PHASE MOTOR
- TABLE IS PRECISION-GROUND TO A MIRROR-LIKE FINISH
- CUTTERHEAD SPEED: 4833 R.P.M.
- RATE OF FEED: 16 F.P.M. & 20 F.P.M.
- MAX. CUTTING WIDTH: 20"
- MAX. CUTTING HEIGHT: 8½"
- MAX. CUTTING DEPTH: ⅛"
- NUMBER OF KNIVES: 4 H.S.S.
- HEAVY-DUTY CAST IRON CONSTRUCTION
- APPROX. SHIPPING WEIGHT: 785 LBS.



ONLY \$1,295⁰⁰

\$150 SHIPPING ANYWHERE IN LOWER 48 STATES

4 BLADE CUTTERHEAD!
Popular Woodworking
TOOL BUYING GUIDE!
Editor's Choice
THE WOOD SHOP
WOODWORKING
TOP PICK

MODEL G1182HW 6" x 47" JOINTER WITH HANDWHEELS

- 1 H.P., SINGLE-PHASE, 110/220V MOTOR (PRE-WIRED TO 110 V)
- HEAVY-DUTY ONE PIECE STEEL STAND W/BUILT IN CHIP CHUTE
- PRECISION GROUND CAST IRON BED
- SUPER HEAVY-DUTY, CENTER-MOUNTED FENCE - POSITIVE STOPS @ 45° & 90°
- 3 KNIFE BALL BEARING CUTTERHEAD
- TABLE SIZE: 6" x 47"
- ½" RABBETING CAPACITY
- APPROX. SHIP. WEIGHT: 215 LBS.



FREE PAIR OF SAFETY PUSH BLOCKS

ONLY \$325⁰⁰

\$55 SHIPPING ANYWHERE IN LOWER 48 STATES

Popular Woodworking
TOOL BUYING GUIDE!
Editor's Choice

MODEL G1182ZX 6" x 47" HEAVY-DUTY JOINTER

- 1 H.P., SINGLE-PHASE, 110/220V MOTOR (PRE-WIRED TO 110 V)
- HEAVY-DUTY ONE PIECE STEEL STAND W/BUILT IN CHIP CHUTE
- PRECISION GROUND CAST IRON BED
- RE-DESIGNED FENCE SYSTEM - POSITIVE STOPS @ 45° & 90°
- 3 KNIFE BALL BEARING CUTTERHEAD
- TABLE SIZE: 6" x 47"
- ½" RABBETING CAPACITY
- APPROX. SHIPPING WEIGHT: 235 LBS.



FREE PAIR OF SAFETY PUSH BLOCKS

ONLY \$475⁰⁰

\$55 SHIPPING ANYWHERE IN LOWER 48 STATES

MODEL G1018HW 8" x 65" SUPER HEAVY-DUTY JOINTER

- 3-KNIFE CUTTERHEAD IS 3" IN DIA. AND RUNS IN SHIELDED, PRE-LUBRICATED BALL BEARINGS
- POWERFUL 1½ H.P., 220V SINGLE PHASE MOTOR
- EASILY PLOWS THROUGH HARDWOODS
- MAXIMUM DEPTH OF CUT IS ½" AND INFED TABLE HAS RABBETING LEDGE
- SUPER HEAVY-DUTY CAST IRON BED
- APPROX. SHIPPING WT. 450 LBS.



ONLY \$695⁰⁰

\$75 SHIPPING ANYWHERE IN LOWER 48 STATES

FREE PAIR OF SAFETY PUSH BLOCKS

New!

MODEL G1035 1½ H.P. SHAPER

- 2 INTERCHANGEABLE SPINDLES: ½" AND ¾"
- HEAVY-DUTY 1½ H.P., 110/220V MOTOR
- TWO SPINDLE SPEEDS: 7,000 AND 10,000 R.P.M.
- SPINDLE OPENINGS: 1¼", 3½", AND 5"
- PRECISION-GROUND CAST IRON TABLE
- TABLE SIZE: 20¼" x 18"
- FLOOR-TO-TABLE HEIGHT: 33½"
- ALL BALL BEARING CONSTRUCTION
- MAX. CUTTER DIAMETER: 5"
- APPROX. SHIPPING WEIGHT: 220 LBS.



G1706 EXTENSION WING SHOWN NOT INCLUDED

ONLY \$425⁰⁰

\$55 SHIPPING ANYWHERE IN LOWER 48 STATES

MODEL G1026 3 H.P. SHAPER

- 3 INTERCHANGEABLE SPINDLES: ½", ¾" AND 1"
- 3" SPINDLE TRAVEL
- HEAVY-DUTY 3 H.P., SINGLE-PHASE, 220V MOTOR WITH REVERSING SWITCH
- TWO SPINDLE SPEEDS: 7,000 AND 10,000 R.P.M.
- SPINDLE OPENINGS: 1¾", 2¾", 4", AND 5½"
- PRECISION-GROUND CAST IRON TABLE
- TABLE SIZE WITH STANDARD WING ATTACHED: 30½" x 28¼"
- FLOOR-TO-TABLE HEIGHT: 34"
- APPROX. SHIPPING WEIGHT: 353 LBS.



ONLY \$825⁰⁰

\$75 SHIPPING ANYWHERE IN LOWER 48 STATES

MODEL G1019Z 14" BANDSAW

- CUTTING CAPACITY/THROAT: 14¼"
- MAXIMUM CUTTING HEIGHT: 6¾"
- OVERALL SIZE: 66"H x 26"W x 22"D
- TABLE HEIGHT ABOVE FLOOR: 42½"
- TABLE TILT: 45° RIGHT, 10° LEFT
- WHEELS: FULLY BALANCED CAST ALUMINUM WITH RUBBER TIRES
- MOTOR: 1 H.P., TEFC, 110V / 220V SINGLE PHASE
- AMPS: 12@110V / 6@220V
- BLADE SPEEDS: 2500 & 3350 F.P.M.
- BLADE SIZE: 98" (½" TO ¾" WIDE)
- APPROX. SHIP. WT. 165 LBS.



ONLY \$335⁰⁰

\$55 SHIPPING ANYWHERE IN LOWER 48 STATES

Z-SERIES

CALL TODAY FOR YOUR **FREE 468 PAGE COLOR CATALOG**

395001658

MEDIA CODE
AD1272

1-800-523-4777

CUSTOMER SERVICE:
(570) 546-9663
FAX: (800) 438-5901

3 Locations: Bellingham, WA • Springfield, MO • Muncy, PA

Circle #123 on Reader Service Reply Card

WE SELL DIRECT TO THE USER! NO DEALERS AND NO MIDDLEMEN! BUY DIRECT & SAVE!

- FULL 1-YEAR WARRANTY ON ALL MACHINES • MOST ORDERS SHIPPED THE SAME DAY
- HUGE PARTS FACILITY WITH OVER 1 MILLION PARTS IN STOCK AT ALL TIMES
- WE HAVE 2 OVERSEAS QUALITY CONTROL OFFICES STAFFED WITH QUALIFIED ENGINEERS



New!

NEW TABLE SAWS FOR 2002!

MODEL G1022PRO 10" HEAVY-DUTY TABLE SAW WITH SHOP FOX® CLASSIC FENCE

- 2 H.P. MOTOR
- PRECISION GROUND TABLE & WINGS
- WIDE & STABLE STAND
- 3/8" x 1 1/4" BALL BEARING ARBOR
- 37" TABLE HEIGHT
- 3 1/8" CUTTING CAPACITY AT 90°, 2 1/8" AT 45°
- SEE THRU BLADE GUARD
- TABLE HAS BEVELED EDGE & T-SLOTS
- 27 1/8" x 40 3/8" TABLE SIZE
- PRECISION SHOP FOX® FENCE
- CAST IRON MITER GAUGE ADJUSTS TO ELIMINATE ANY PLAY IN MITER SLOT
- MACHINED STEEL PULLEYS
- POWER TWIST® DRIVE BELT
- 4" DUST PORT • 25" RIP CAPACITY
- SMOOTHER ACTION HANDWHEELS
- SHIPPING WEIGHT APPROX.: 290 LBS.

INCLUDES SHOP FOX® CLASSIC FENCE!



FULLY ADJUSTABLE CAST IRON MITER GAUGE

ONLY \$550⁰⁰
\$75 SHIPPING ANYWHERE IN LOWER 48 STATES

MODEL G1023SL 10" LEFT-TILTING SUPER HEAVY-DUTY TABLE SAW

- 3 H.P. SINGLE-PHASE, 220V MOTOR
- SOLID CAST IRON TABLE
- TABLE HAS T-SLOTS SO YOUR MITER GAUGE WILL NOT FALL OFF THE TABLE WHEN RETRACTED
- TABLE SIZE (WITH 2 SOLID EXTENSION WINGS ATTACHED) IS 40 3/8" x 27"
- EXTRA-LARGE HANDWHEELS
- CUTTING CAPACITY: 8" LEFT AND 26" RIGHT OF BLADE
- MAXIMUM DEPTH OF CUT @ 90°: 3"
- MAXIMUM DEPTH OF CUT @ 45°: 2 1/8"
- 3/8" DIAMETER ARBOR IS LONG ENOUGH TO ACCEPT DADO BLADES UP TO 1 3/8"
- ONE-PIECE STEEL CABINET-TYPE STAND
- MAGNETIC SAFETY SWITCH IS STANDARD
- ALL SEALED BALL BEARING CONSTRUCTION
- TRIPLE V-BELT DRIVE
- POWDER COATED PAINT
- SHIPPING WEIGHT APPROX. 430 LBS.

New!



INTRODUCTORY PRICE \$895⁰⁰
\$75 SHIPPING ANYWHERE IN LOWER 48 STATES

MODEL G1022SM 10" HEAVY-DUTY TABLE SAW

- TABLE SIZE W/ EXTENSION WINGS: 27 1/8" x 40 3/8"
- RAIL DIMENSIONS: 44" x 1 1/8" • MAX. RIPPING CAPACITY: 24"
- CUTTING CAPACITY AT 90°: 3 1/8" • CUTTING CAPACITY AT 45°: 2 1/8" • 1 1/2" H.P., SINGLE-PHASE, 110/220V MOTOR (PRE-WIRED TO 110V)
- APPROX. SHIPPING WEIGHT: 220 LBS. • PRECISION GROUND CAST IRON TABLE

TOOL BUYING GUIDE Editors' Choice



ONLY \$325⁰⁰
\$55 SHIPPING ANYWHERE IN LOWER 48 STATES

MODEL G7947 12 SPEED 17" FLOOR DRILL PRESS

- 1 H.P., SINGLE PHASE, 110V/220V MOTOR
- 12 SPEEDS: 210-3300 RPM
- OVERALL HEIGHT: 64 1/2" • SWING: 17"
- DRILL CHUCK: 3/8" • DRILLING CAPACITY: 1" STEEL
- SPINDLE TAPER: MT #3 • SPINDLE TRAVEL: 4 1/4"
- TABLE SIZE: 13 3/8" Sq.
- PRECISION GROUND CAST IRON TABLE
- TABLE TILT: 90° IN BOTH DIRECTIONS
- APPROX. SHIPPING WEIGHT: 275 LBS.



BUILT-IN LIGHT! (BULB NOT INCLUDED)

ONLY \$375⁰⁰
\$75 SHIPPING ANYWHERE IN LOWER 48 STATES

MODEL G1066 24" DRUM SANDER

- 5 H.P., 220V DRUM MOTOR DRIVES 2 ALUMINUM SANDING DRUMS
- 1/4 H.P. CONVEYOR MOTOR GIVES AN 11 FPM RATE OF FEED
- 2 BUILT-IN 4" DUST PORTS FOR EASY HOOK-UP TO COLLECTION SYSTEM
- ALL STEEL AND BALL BEARING CONSTRUCTION
- STATE-OF-THE-ART COMPUTER BALANCED DRUMS
- HANDLES STOCK UP TO 2 3/8" WIDE x 4 1/4" THICK
- APPROX. SHIPPING WEIGHT: 430 LBS.



ONLY \$1095⁰⁰
\$75 SHIPPING ANYWHERE IN LOWER 48 STATES

New!

MODEL G9983 15" WIDE-BELT SANDER (OPEN END)

- OVERALL DIMENSIONS: 61 3/4" H x 32 1/2" D x 35" W
- CONVEYOR SPEED 13 & 16.4 F.P.M.
- BELT FEED MOTOR: 1/4 H.P.
- SANDING BELT MOTOR: 5 H.P.
- REQUIRES SINGLE-PHASE, 220V ELECTRICAL AND 50-70 PSI AIR
- INCLUDES EXTENDED SUPPORT BAR FOR WIDE BOARDS
- APPROX. SHIPPING WEIGHT: 1,000 LBS.



ONLY \$2,795⁰⁰
\$200 SHIPPING ANYWHERE IN LOWER 48 STATES

MODEL G9922 OSCILLATING SPINDLE SANDER

- 1/2 H.P., SINGLE PHASE, 4.6 AMP. TEFC MOTOR
- GROUND CAST IRON 14 1/2" x 14 1/2" TABLE TILTS TO 45°
- STROKE LENGTH: 1"
- FLOOR-TO-TABLE HEIGHT: 39 1/2"
- BUILT-IN 2" DUST COLLECTION PORT
- 3450 R.P.M. SPINDLE SPEED
- SPINDLE OSCILLATES AT 64 STROKES-PER-MINUTE
- SHIELDED & PERMANENTLY LUBRICATED BALL BEARINGS
- INCLUDES 80 GRIT SLEEVE FOR SPINDLE, MITER GAUGE AND WRENCH SET
- APPROX. SHIPPING WEIGHT: 95 LBS.



ONLY \$175⁰⁰
\$30 SHIPPING ANYWHERE IN LOWER 48 STATES

MODEL G1071 OSCILLATING SPINDLE SANDER

- 1 H.P., SINGLE PHASE, 110/220V, TEFC MOTOR
- PRECISION GROUND CAST IRON 25" x 25" TABLE TILTS TO 45°
- STROKE LENGTH: 1 1/2"
- FLOOR-TO-TABLE HEIGHT: 35 1/2"
- BUILT-IN 4" DUST COLLECTION PORT
- 1725 R.P.M. SPINDLE SPEED
- SPINDLE OSCILLATES AT 72 S.P.M.
- 10 TAPERED AND THREADED SPINDLE SIZES
- PERMANENTLY LUBRICATED BALL BEARINGS
- INCLUDES 100 GRIT SLEEVE FOR EACH SPINDLE, MITER GAUGE AND WRENCH SET
- APPROX. SHIPPING WEIGHT: 300 LBS.



ONLY \$525⁰⁰
\$75 SHIPPING ANYWHERE IN LOWER 48 STATES

MODEL G1029 2 H.P. DUST COLLECTOR

- MOTOR AMP DRAW: 12 AMPS (220V ONLY)
- 2 H.P., 220V, SINGLE-PHASE MOTOR
- R.P.M.: 3450
- STANDARD BAG FILTRATION: 30 MICRON
- PORTABLE BASE SIZE: 21 1/2" x 33 1/2"
- AIR SUCTION CAPACITY: 1550 C.F.M.
- STATIC PRESSURE: 12.3"
- APPROX. SHIPPING WEIGHT: 130 LBS.



WOODWORKING READER'S CHOICE AWARDS 2002

FREE CYCLONE SEPARATOR!

ONLY \$249⁹⁵
\$55 SHIPPING ANYWHERE IN LOWER 48 STATES

grizzly.com

OVER 10,000 PRODUCTS AVAILABLE ONLINE!

RECEIVE A **FREE GIFT** WITH EVERY ONLINE ORDER
(LIMITED TIME OFFER)

Circle #124 on Reader Service Reply Card





©2001 AMERICAN TOOL
COMPANIES, INC.

A vise you
can use in the
comfort of your
own _____.



QUICK-GRIP®
QUICK-VISE™ Portable Vise

The QUICK-VISE™ is lightweight, durable, and works wherever you do. QUICK-GRIP® Clamping Tools — they'll change the way you work. For more information: quickvise.com

Circle #101 on Reader Service Reply Card

contents

Popular Woodworking



TOOLS AND TECHNIQUES

16 Turn Your Moto-Tool Into a Plunge Trimmer

TRICKS OF THE TRADE

Build a spring-loaded base to turn your Dremel or other moto-tool into a plunge trimmer — the perfect tool for inlay and small-scale work. Also, add storage and dust collection beneath your contractor saw with one piece of plywood and learn the trick to setting your hand plane blades square.

18 New Professional-Quality Sanders from Makita

TOOL TEST

Makita has introduced two new random-orbit sanders for the industrial market that home woodworkers should take a serious look at. Also, we shoot a bunch of brads with the new nailer from DeWalt and run down a bunch of rough stock with the new two-speed 13" planer from Delta.

20 Ridgid EB4424 Oscillating Belt/Spindle Sander

ENDURANCE TEST

Most of us would like to have an oscillating spindle sander, an edge sander and a 3,000-square-foot shop. Ridgid helps you with those first two wishes with its EB4424, a benchtop machine that does the job of both. We've been using this machine for more than two years and are ready to tell you how it fared.

22 Clamp Assist

INGENIOUS JIGS

These three simple clamping jigs make difficult tasks easy — especially for those of us who don't have a wall of clamps. Nick Engler's three jigs will help make your projects perfectly square, help you clamp to the middle of a panel and put pressure in odd spots.

By Nick Engler

36 Clash of the Contractor Saws

Selecting a table saw is one of the most important (and sometimes agonizing) decisions for a woodworker. So we got down and dirty with nine premium contractor saws to find out who is making the best machine. And once you buy the right saw, we'll show you the correct and practical way to make difficult rips and crosscuts without getting hurt.

50 Ultrafast Frame and Panel

Building a frame-and-panel door can seem daunting to beginning woodworkers. Spend a day in a commercial shop learning to build traditional doors with a minimum of fuss and tooling.

By Troy Sexton

68 Dealing With Wood Movement

The trick to mastering wood movement is to plan for it when you design your projects. Here are eight time-tested (though not always obvious) ways to ensure your projects expand and contract with the seasons without self-destructing.

By Lonnie Bird

84 Making Your Own Chisel Handles

Buying chisels is a compromise between good steel and a comfortable handle. Here's a tip: Buy the chisel with the best steel and make your own handle. It's easy and can be done with or without a lathe.

By Roger Holmes

94 Caring for Furniture

FLEXNER ON FINISHING

After a piece of furniture leaves your shop, its new owners want to take care of it. But here's the problem: some claims made by furniture-care products are misleading or just wrong. Find out the truth about these products and what they're actually good for.

By Bob Flexner



continued on page 4

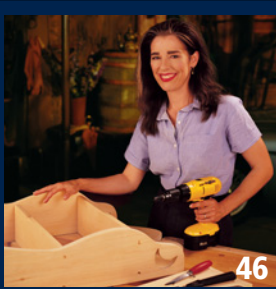

46

ON THE COVER

To make nice projects, you don't have to have a production shop in your basement. Mag Ruffman shows you how to build this shelf unit using handheld power tools and common materials from your local home center.

Cover photo by Al Parrish

IN EVERY ISSUE

8 **Out on a Limb**
A Better Magazine

10 **Letters**
Mail from readers

12 **Q & A**
We answer readers' most difficult questions

27 **American Woodshops**
Scott Phillips gives you an inside look at Kelly Mehler's shop.

83 **Projects from the Past**
Pier cabinet

91 **Caption the Cartoon**
Win a Freud FJ85 jigsaw

96 **Out of the Woodwork**
Sacrificial Scraps by Joe Pescatello

PROJECTS

30 **Classic Shaker Candlestand**

This traditional form requires a little turning, a little joinery and a little finesse. Cabinetmaker Malcolm Huey shows you all three in our plans for this beautiful tiger maple table.

By Malcolm Huey

46 **Contractor Saw Outfeed Tables**

For years, our editor has relied on these two simple tables to catch long rips, support long crosscuts and generally serve as assembly tables. Build them this weekend and they'll serve you for decades to come.

56 **Tank Heaven**

Mag Ruffman's show on Canadian TV, "Anything I Can Do," is hands-down the funniest woodworking show we've seen. (Well, OK, it's the funniest show that is *supposed* to be funny.) We've smuggled Mag across the border so you can enjoy her brand of humor and build this useful over-the-potty cabinet.

By Mag Ruffman

63 **Inlay Door with a Router**

SECOND OF TWO PARTS

Last issue we showed you how to build the carcass of this 18th-century Pennsylvania spice box. This issue we make the inlay door using your band saw, router and our specially designed templates. Even if you've never inlaid a single piece of wood, you can make this door with our drawings and instructions.

By Glen Huey



62



30

72 **Asian Bedside Table**

This frame-and-panel case piece features sliding doors with a traditional Tansu touch, a shelf for your nightly reading material and a top reminiscent of a pagoda.

78 **A Lamp Called Wanda**

This fish-shaped lamp is the latest creature to crawl from the dark recesses of John Hutchinson's mind. With our scaled drawings and step photos, you'll find this cheery lamp a breeze to build.

By John W. Hutchinson

89 **Bench Deadman**

Working on the edge of a long board or a big panel is a clamping nightmare. For less than \$10, you can rig your bench with this traditional fixture that will make difficult clamping chores easier.

Popular Woodworking (ISSN 0884-8823, USPS 752-250) is published six times a year in February, April, June, August, October and December by F&W Publications, Inc. Editorial and advertising offices are located at 1507 Dana Ave., Cincinnati, OH 45207; tel.: (513) 531-2222. Unsolicited manuscripts, photographs and artwork should include ample postage on a self-addressed, stamped envelope (SASE); otherwise they will not be returned. Subscription rates: A year's subscription (6 issues) is \$24.96; outside of U.S. add \$7/year • Canada Publications Mail Agreement No. 40025316. Canadian return address: 2744 Edna St., Windsor, ON N8Y 1V2 • Copyright ©2001 by *Popular Woodworking*. Periodicals postage paid at Cincinnati, Ohio, and additional mailing offices. Postmaster: Send all address changes to *Popular Woodworking*, P.O. Box 5369, Harlan, IA 51593 Canada GST Reg. # R122594716 • Produced and printed in the U.S.A. Ride-along enclosed in polybag version 52000.

Bonds Everything ~~But~~ ^{including} The Kitchen Sink.

For over 50 years, Titebond® glues and adhesives have set the industry standard for excellence in performance and application. Introducing the HiPURformer™ Advanced Bonding System. It combines the highest-quality polyurethane hot-melt adhesives with the most efficient, cost-effective application system.

Throw in the kitchen sink and you've got the perfect solution for all your bonding needs.

leather, porcelain, marble, metals, glass, FRP, stone, foamboard, moldings, fabrics (textiles), brick, plastics, concrete, melamine, wood, ceramic... even the kitchen sink.

Don't let this unique opportunity go down the drain. Call today for more information on how the HiPURformer™ Advanced Bonding System will improve your woodworking, remodeling and repair experience.



Franklin International

Columbus, Ohio 43207 • 800-347-4583 • titebond.com

Circle #105 on Reader Service Reply Card

THE STANDARD IN SANDERS



Clayton Spindle Sanders are built in the USA with precision balanced spindles, oversized bearings, and a premium Baldor Induction Motor.

- Benchtop and full-sized, professional models
- Large table surface
- Built-in dust port
- Quick-change drums

Clayton tackles the toughest sanding jobs...smoothly.
FREE COLOR CATALOG, call: 1-800-971-5050

CLAYTON
Spindle Sanders

CLAYTON MACHINE CORP.

ROYAL OAK, MI 48068-0520

Circle #102 on Reader Service Reply Card

Popular Woodworking®

February 2002, Vol. 22, No. 1
www.popularwoodworking.com

Editor & Publisher **Steve Shanesy**

Art Director **Tricia Barlow**

Senior Editors **David Thiel, Christopher Schwarz**

Project Illustrator **John W. Hutchinson**

Photographer **Al Parrish**

Contributing Editors

Nick Engler
Bob Flexner
Glen Huey
Scott Phillips
Troy Sexton

Technical Advisers:

Bill Austin Makita USA, Inc.
Scott Box Delta International
Chris Carlson S-B Power Tool
Bill Crofutt Grizzly Industrial
Dale Zimmerman Franklin International

Senior Vice President **David Lewis**

Editorial Director **David Fryxell**

CIRCULATION

David Lee, Vice President

Lynn Kruezkamp, Group Manager

PRODUCTION

Barbara Schmitz, Vice President
Heather Griffin, Production Coordinator

ADVERTISING

Advertising Director

Don Schroder

331 N. Arch St., Allentown, PA 18104
Tel. (610) 821-4425; Fax (610) 821-7884
d.schroder@verizon.net

Classified Advertising Sales

Joan Wright, Tel. (800) 388-1820
joanwright@ix.netcom.com

Advertising Production Coordinator

Debbie Thomas, Tel. (513) 531-2690, ext. 219
debbiet@fwpubs.com

SUBSCRIPTION SERVICES Subscription inquiries, orders and address changes can be made at www.popwood.com (click on Subscriber Services). Or by mail: Popular Woodworking, P.O. Box 5369, Harlan, IA 51593 or call (515) 280-1721. Include your address with all inquiries. Allow 6 to 8 weeks for delivery.

NEWSSTAND DISTRIBUTION Curtis Circulation Co., 730 River Rd., New Milford, NJ 07646, (201) 634-7400, fax (201) 634-7499

ATTENTION RETAILERS:

To carry Popular Woodworking in your store, call Reader's Service at 800-844-7075, or write: Popular Woodworking Magazine Dealer program, c/o Reader's Service, 4099 Martel Road, Lenoir City, TN 37772

Back issues are available for \$6.50 (\$8.50 Canada; \$10.50 other foreign). Ohio residents include 6% sales tax.

Send check or money order to: Popular Woodworking/F&W Publication Products, PO Box 2031, Harlan, IA, 51593 or call 1-888-419-0421. Please specify publication, month and year.



ProLift™
Router Adjustment System

- Zero-out at any bit height
- Fine adjustment tool included
- Two models - cast iron or aluminum
- Change and adjust bits above the table
- Accommodates most fixed base routers
- Cooling fins for longer motor life
- Heavy-duty construction reduces vibration
- Metal reduction rings for three bit openings
- Fits all ProTop router tables without modification

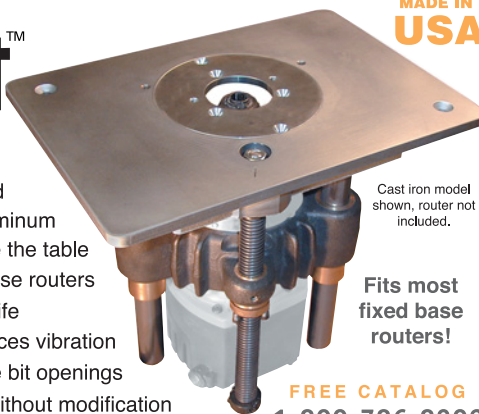

MADE IN USA

Cast iron model shown, router not included.

Fits most fixed base routers!

FREE CATALOG
1-800-786-8902

Circle #117 on Reader Service Reply Card

HIGH PERFORMANCE MOBILIZATION



What's under your machine?

HTC Mobile Bases give you convenient shop clean-up, make moving, using and storage a breeze — and open-up valuable shop space for more equipment. Making it mobile just makes sense! *What are you waiting for?*



For your nearest dealer and FREE catalog, call toll-free 1-800-624-2027



© HTC Products, Inc. 2001

Circle #107 on Reader Service Reply Card

It's here!

The new high-performance production router from Fein.



Powerful. FEIN's new 3¼ horsepower plunge router will cut production time and give you a superior finish.

Smooth. Thanks to an advanced electronic feedback circuit and soft start, this state-of-the-art router operates at a consistent torque and speed for smooth operation and a cleaner edge.

Lightweight for greater control. The RT-1800 is two pounds lighter than others in its class, and has a wider range of speeds. Includes dust collection port, and QC spindle.

Learn more. Call 1-800-441-9878 for more information and a dealer near you, or visit us on the web at www.feinus.com.

Finishing is just the beginning
Fein Power Tools, Inc. 1030 Alcon St. Pittsburgh, PA 15220
1-800-441-9878 www.feinus.com

Fein 

A Better Magazine

We've added more pages, writers and a beefier cover.

If you read this column with any regularity you know I don't waste this space by telling you what you're going to find in this issue. I'm confident you'll find it in the table of contents without any help from me. I prefer to write about something that I hope you will conclude has some value.

This time around, however, I do want to share with you some goings-on with your magazine that happen to begin in this issue. And besides, a little good news is a nice break from the stretch of bad news we've been getting lately.

Perhaps most important to you is the addition of Lonnie Bird as a regular contributor. Of Lonnie's many skills, I'm not sure which to rate as his strongest — woodworking or teaching. His mastery of the craft ranks him up there as one of the best in the United States, especially when it comes to traditional furniture styles. But Lonnie has been teaching woodworking for years to students who went on to become full-time career woodworkers. This combination — his deep knowledge of the craft and his keen ability to share that knowledge and make it understandable — even to beginners, is a true gift.

In Lonnie's first article, he explains why wood expands and contracts and how to deal with it. You might have read about this subject before, but I promise that reading Lonnie's take on it will surely teach you something you didn't know before. Next issue, he'll explain how to use a cutting list. Believe me, there's more to it than meets the eye.

We're also starting a new column in this issue called "Q&A." I think you'll find it helpful because it is somewhat like "Tricks of the Trade." Each month we answer hun-

dreds of woodworking questions from readers that come in on the phone, in the mail and in our e-mail. We're publishing the best questions in this new column, and some really good answers, too.

More good news is the quality of the magazine you are holding in your hands. We've been working hard to bring you quality projects, technique stories and tool reviews. But now we are bringing you a higher quality manufactured product, too. For example, this issue is 100 pages long. Last year, this issue was about 90 pages. Your extra pages are being used for more articles, I should add, not more advertising.

You might notice the paper on the cover is heavier, too. We know many of you save your issues, sometimes for years, and this better paper will help preserve your magazines for years to come. And it also will take more abuse as your issue travels through the postal system.

This issue is also wider than what you are accustomed to receiving. The extra width will allow us to present photos and drawings more clearly. It's not a huge difference, but it helps. I think you'll notice that there's a different look and feel to this issue compared to those in the recent past.

All these changes add up to our determination to produce a better magazine in every way. Over the years we've been building a team of top-drawer contributors. I'm proud of the fine work they regularly produce for you. It pleases me greatly to now bring more of that work to you in a better quality magazine. **PW**



SAWSTOP UPDATE

In last month's column I invited you to weigh in on a new product called SawStop. It's a passive safety device which, if it is found to be effective in the long term, could save many woodworkers' fingers. Many of you visited our website and cast your votes, for which I thank you. So far, more than 1,300 readers have voted with nearly 75 percent saying they'd pay \$150 extra to have such a device on their table saw. In the next issue, I'll give you the final results and some reaction from machinery manufacturers.

CONTACT INFORMATION

Steve Shanesy

Editor & Publisher

Specialties: Projects, new products and tools, tricks of the trade
513-531-2690 ext. 238
steve.shanesy@fwpubs.com



David Thiel

Senior Editor

Specialties: Projects, new products and tools, tricks of the trade
513-531-2690 ext. 255
david.thiel@fwpubs.com



Christopher Schwarz

Senior Editor

Specialties: Author liaison, website, projects, hand tools
513-531-2690 ext. 407
chris.schwarz@fwpubs.com



Tricia Barlow

Art Director

Specialties: Magazine and cover design, photo direction
513-531-2690 ext. 599
tricia.barlow@fwpubs.com



Got Questions or Problems With Your Subscription?

To report problems with your subscription visit our website at popwood.com, call our subscription offices at 515-280-1721, or write to *Popular Woodworking*, P.O. Box 5369, Harlan, IA 51593.

Our Privacy Promise to You

We make portions of our customer list available to carefully screened companies that offer products and services we believe you may enjoy. If you do not want to receive those offers and/or information, please let us know by contacting us at: List Manager, F & W Publications, 1507 Dana Ave., Cincinnati, OH 45207

SAFETY NOTE

Safety is your responsibility. Manufacturers place safety devices on their equipment for a reason. In many photos you see in *Popular Woodworking*, these have been removed to provide clarity. In some cases we'll use an awkward body position so you can better see what's being demonstrated. Don't copy us. Think about each procedure you're going to perform beforehand. Safety First!

Standing out from the competition...

at every angle.

JET proudly presents the Gold Series — our best-selling tools matched with a **FREE** accessory package!

Contractor-Style Tablesaw with cast-iron wings, \$649**
28-tooth carbide-tipped blade **FREE**
SAVE \$99**

**after \$50 rebate

\$50
REBATE

\$50 rebate on all JWTS-10CW cast-iron wing models.
\$25 rebate on all JWTS-10 steel wing models.



Tools pictured:

18" Bandsaw, \$1,099*
3 blades **FREE**
SAVE \$49

16½" Drill Press, \$399*
Mortising attachment and 3 bits **FREE**
SAVE \$176

15" Closed Stand Planer, \$1199*
Extra knife set **FREE**
SAVE \$59

1100 CFM Dust Collector, \$299*
One tool connection kit **FREE**
SAVE \$49

1236 Wood Lathe with stand, \$579*
8-piece chisel set **FREE**
SAVE \$39

PERFORMAX
16-32 Plus Drum Sander, \$799*
Caster set and 2 extra boxes of sandpaper **FREE**
SAVE \$146

Tools not shown:

XACTA SAW™
left- and right-tilt, 3 HP, \$1499*
Table and legs set **FREE**
SAVE \$199

Mini Lathe, \$349*
18-piece pen turning kit **FREE**
SAVE \$129

1000 CFM Air Filtration System, \$239*
Extra electrostatic outer filter **FREE**
SAVE \$39

6" Closed Stand Jointer, \$499*
2 extra knife sets **FREE**
SAVE \$148

1½ HP Closed Stand Shaper, \$699*
12-piece carbide router bit set **FREE**
SAVE \$149

14" Closed Stand Bandsaw, \$599*
Rip fence and mitre gauge **FREE**
SAVE \$130

POWERMATIC

JET **PERFORMAX**

A Family Of Brands

The **Precision Router Lift**
by Woodpeckers



Reg. \$299
SALE
\$269

Built for performance, the new PRL from Woodpeckers delivers total control for table mounted, fixed based routers. *Uncompromising construction, machine-shop accuracy.*

- Change bits above the table.
- Includes (3) aluminum twist lock rings.
- Adjustable index scales.
- Elevated crank handle.



1.800.752.0725 • www.woodpeck.com

Circle #134 on Reader Service Reply Card

LETTERS

Lock Your Mortiser's Holddown Forever

Off-the-Rack Hardware Solves Machine's Most Nagging Problem

I solved my holddown problem on my Fisch mortiser by replacing the post that the forked holddown rides on with a 14mm bolt (approximately the same diameter as the hold-down shaft) that I bought from the hardware store.

I cut off the bolt's head, ground a flat surface on one side of the bolt along the threaded end and then ground a notch at the other end as suggested in your article ("A New Manual for Mortisers" August 2001, issue #123).

I installed the bolt in the hole in the fence and rotated the bolt so that the flat aligned with the set screw on the forked hold-down. I put the holddown on the bolt, then put a washer on top of that and threaded a nut onto the top of the bolt.

One could also include a lock nut, but this has not proven to be necessary.

Floyd B. Carothers
Pittsburgh, Pennsylvania

Editor's note: Well Floyd, you seem to have simply solved the problem that has dogged a lot of us for years. If you didn't read the original article in the August issue, the "notch" Floyd refers to is simply ground into your holddown's post at the point where the setscrew contacts the post. Make the notch about 1/8" deep by using your grinder. The notch prevents the post from coming out of its socket in the fence, and Floyd's solution prevents the forked holddown from coming loose during use. Together, these two simple modifications make your holddown far superior to the factory equipment.

— Christopher Schwarz, senior editor

Best New Tool of 2001 Could Turn Out to Be a Finger-Slicing Machine

I've received my December 2001 issue of *Popular Woodworking*, and after looking at your list of the Best New Tools of 2001, I have to wonder how, by any standard, you

could have come up with this list. Some do have merit, but when you listed the Craftsman Laser Miter Saw, all interest in your selections was lost.

The laser you speak of will, in my opinion, eventually be the cause of many wood-working accidents. The laser works using centrifugal force. So the saw must be running in order to align the cut mark with the laser. Moving your hands under a turning blade is a bit like the "Perils of Pauline."

With the many upgrades and improved technology in 2001, this in my opinion should be on a list of the 15 worst of 2001. Many woodworkers would love a quality laser miter saw, but I definitely wouldn't recommend this one.

Al Berube
Salisbury, Massachusetts

Editor's note: You bring up a good point about safety concerning the use of miter saws, but I'm afraid we have to disagree with you about the safety of this particular tool. In general, many miter saw users have developed the habit of lowering the blade to the workpiece (without the saw running) to allow the guard to retract and align the blade with the cut mark. If this is a habit they are unable to break, then this is not the saw for them. But as the saw is designed, the laser functions through the guard with the blade arm in the

WRITE TO US

Popular Woodworking welcomes letters from readers with questions or comments about the magazine or woodworking in general. We try to respond to all correspondence. Published letters may be edited for length or style. All letters become the property of *Popular Woodworking*. How to send your letter:

- E-mail: Popwood@FWPubs.com
- Fax: 513-531-0919
- Mail carrier:
Letters • Popular Woodworking
1507 Dana Ave., Cincinnati, OH 45207

SUPERSHOP 10-IN-1 WOOD & METAL SHOP

BECOME A BETTER WOODWORKER - GUARANTEED!

You'll make projects with higher QUALITY, PRECISION, SPEED & SKILL!



SuperShop will increase your woodworking skills or WE'LL BUY IT BACK!

- New, different & BETTER than "look-a-like" machines
- 10 most-used tools in 1 for ultimate versatility
- Rock-solid 450 lbs., 2.5 times MORE than others
- State-of-the-art ELECTRONIC speed controls
- Extra POWER-IN-RESERVE DC motor
- 30-Day RISK FREE Buy-Back Offer & industry-leading Warranty



Get your FREE SUPERSHOP REPORT - "Better Woodworking GUARANTEED!"

CALL TOLL FREE
1-800-476-4849

Or this Mail to: SuperShop® Dept. WW, P.O. Box 1517, Ann Arbor, MI 48106

YES! Tell me how SuperShop will increase my craftsmanship. Rush facts, specs, and CURRENT SALE OFFER!

Name _____
Address _____
City _____ State _____ Zip _____

Circle #113 on Reader Service Reply Card

fully up position. There is no need to lower the blade to the work. Because of this, even though the blade must be spinning to make the laser function, it is still covered by the guard. Again, if you still need to lower the blade to the work and aren't comfortable relying on the laser, then please choose another saw that won't provide an incentive to unsafe shop practices. Thanks for keeping safety in our minds.

—David Thiel, senior editor

Where Do I Find Glaze for the Morris Chair Project?

I recently read your article on building a Morris chair (June 2000, issue #115) and would like to find out more information on Lilly's warm brown glaze. If you could provide me with a website address, phone number or a company that sells it, it would be most appreciated.

David Smith
Ocean City, New Jersey

Editor's note: We've had more than 100 requests from people looking to find a good source for Lilly's glaze. The fastest way is to check with your local paint store, especially one that caters to professional painters. If that doesn't work, I recommend you go to woodfinishingsupplies.com. PW

—Christopher Schwarz, senior editor

CORRECTIONS & CLARIFICATIONS

In our article on cryogenics in the December 2001 issue, we inadvertently left out one of the labs that you can send your tooling to. Performance Cryogenics has offices in Cleveland, Ga., and Mooresville, N.C. You can reach the company by calling 877-219-3556 or at www.percryo.com.

In our special Outdoor Furniture issue, which was available only on the newsstands, there are two corrections to the Outdoor Morris chair article. The four rear leg pieces should be 20¹/₈" long instead of 21". Also, in the drawing labeled "profile," the front leg dimension is called out at 2¹/₄". It should be 2³/₄", as stated in the cutting list.

In the Tractor-Trailer Toy Box (December 2001, #125), there is a correction to the drawing labeled "Trailer box assembly plan." The hole for the hitch platform dowel should be 1¹/₈" instead of 1/8".

In our 2002 Tool Buying Guide (#124), the key to the chart on page 80 was inadvertently omitted. DB=dust bag, DC=dust canister, VP=vacuum port, OPT=optional.

FREE TOOL CATALOG!

Your Best Work Starts With Us... With over 8,000 of the finest woodworking tools in the world, Woodcraft can help you work more efficiently and skillfully than ever. Call for your Free copy today.

WOODCRAFT
Helping You Make Wood Work®
1-800-542-9115
www.woodcraft.com

560 Airport Ind. Park, Dept. 02PW01T
PO Box 1686, Parkersburg, WV 26102-1686

Circle #114 on Reader Service Reply Card

For a dirt & dust free finish

GET IT ALL

with Datco
Surgical Blue™
& Professional™
Tack Cloth



DATCO
INTERNATIONAL, INC.
Call 1-800-TACKCLOTH
or order online at www.tackcloth.com

Circle #103 on Reader Service Reply Card

The Toughest Glue On Planet Earth

You're beyond simple yellow glues and you don't want a different bottle of glue for every project. You want Gorilla Glue®. Bonds wood, stone, metal, ceramic, plastics and more. Incredibly strong and 100% waterproof. Don't monkey around with other glues.

For retailer near you, call
800-966-3458 or visit
www.gorillaglu.com.



for retailers near you:
www.gorillaglu.com
1-800-966-3458

CRAFTSMAN

**Advanced router table
engineering made simple
for your workshop!**



**Routers mount easily through
an opening in the tabletop**

No more fumbling underneath the table. Install your router thru the 11 3/8-in. x 9-in. opening on top. Mounting plate is keyed to ensure proper installation.



**Innovative 3-piece fence adjusts,
allowing you complete flexibility**

The fence opening can be adjusted to match the varying diameters of your router bits.



**Unique offset joining system on the
fence helps make work edges true**

By adjusting the fence, you can offset the outfeed fence so the workpiece is supported for joining cuts.



Includes three table inserts

The varying size inserts provide you with additional workpiece support and proper bit clearance.

Available at Sears, Sears Hardware,
and the Craftsman Catalog
at 800-437-9686

SEARS
Where else?

Circle #130 on Reader Service Reply Card

Cabinet Scrapers

Save Your Thumbs

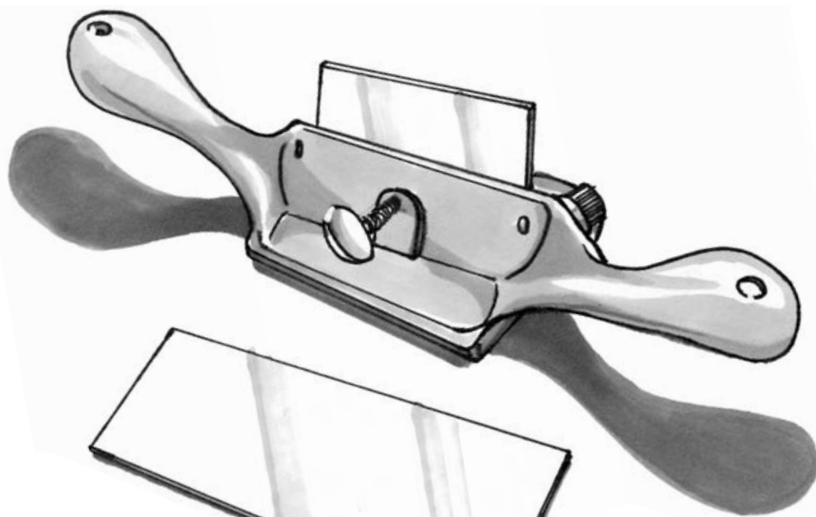

Illustration by Hayes Shanesy

What's the Difference Between a Scraper and a Cabinet Scraper?

Isn't a scraper and cabinet scraper the same thing, just different names for the same tool? And if not, what is the difference?

There's often confusion when woodworking terms are used incorrectly or interchangeably. One case in point is the scraper vs. a cabinet scraper. Although each puts a fine finish on a board, they are different tools. The scraper, or more accurately scraper blade, is either a rectangular piece of steel or is rounded and called a gooseneck scraper. It is used for smoothing the inside radii of mouldings and such. The cabinet scraper, on the other hand, uses a scraper blade that is held in a cast-iron body that has a milled bottom where the blade protrudes slightly, much like a plane iron in a hand plane.

Scraper blades are versatile and can be used for rough or fine work, from scraping glue to final smoothing for the truly practiced. What's an anomaly about this whole "name" question is that if properly sharpened with a correct hook, scrapers don't scrape at all. They actually cut the wood fibers cleanly without tearing or pulling.

The cabinet scraper also has many uses. It can remove an old finish or prepare a wood surface before sanding. A cabinet scraper can be

especially effective in smoothing highly figured wood like burls and is also effective on delicate veneers.

One big advantage a cabinet scraper has over a scraper blade is ease of use. The user's hands don't fatigue nearly as fast as compared with the scraper blade.

— Steve Shanesy, editor and publisher

Dealing With Unusual Miter Slots

I'm a beginning woodworker looking at buying the Delta 34-183 tenoning jig, and it (along with several other manufacturer's jigs) requires a 3/8" x 3/4" miter slot. I own a bare-

WRITE TO US

Every day we get questions from readers on all subjects about their woodworking. Some are letters, many are e-mail messages. We are more than happy to share our woodworking experience with you by answering your questions or adding some clarity to whatever aspect of your craft you are unsure about. In addition to the hundreds we answer privately every month, we want to share the best questions here with readers.

Send your questions via e-mail to popwood@fwpubs.com. Or send us a note by mail to: *Popular Woodworking*, Q&A, 1507 Dana Ave., Cincinnati, OH 45207.

YOUR NEW ROUTE TO PRECISE WOODWORKING!



THE ULTIMATE IN CRAFTSMAN ROUTER TABLES IS NOW HERE!

Making precise cuts with confidence just became much easier. A 486 sq.in. die-cast worksurface can handle projects both large and small. Easy-to-read reference scales help you place the fence with great accuracy. Our innovative drop-in mounting plate lets you mount your router easily from the top. A clear, anti-friction coating helps prevent scratching or discoloring of the workpiece. In addition to providing valuable storage, the heavy-duty workstand places the router tabletop at an optimal 39-in. work height. Just the right size for expanding your woodworking horizons. Visit your nearest Sears or Sears Hardware store.

CRAFTSMAN[®]

PROFESSIONAL

MAKES ANYTHING POSSIBLESM

© 2001 Sears, Roebuck and Co.

Circle #130 on Reader Service Reply Card

How to Heat Water...

1. Heat it *Efficiently*

Bosch AquaStar heats water only when hot water is used, so you save up to 50% on energy bills.

2. Heat it *Instantly*

You'll never run out of hot water since Bosch AquaStar heats water instantly for as long as it's needed.

3. Heat it *Inconspicuously*

Bosch AquaStar is small enough to hang in a closet. Power vented models let you vent the unit horizontally.

4. Heat it for the *Long Term*

The Bosch reputation for quality is backed by a 15-year warranty.*

* when installed professionally

BOSCH AquaStar
Bosch AquaStar tankless water heaters provide instant and efficient hot water for the whole house. To see which Bosch AquaStar is right for you, call us or visit our Web site.



A.P.W.0102

CONTROLLED ENERGY CORPORATION

WAITSFIELD, VERMONT

www.ControlledEnergy.com/pw | 800-642-3199

Circle #118 on Reader Service Reply Card

Q&A

bones Skil table saw. I took a look at my miter slots, and they're each about $\frac{3}{32}$ " narrower than $\frac{3}{4}$ ", and a tad shallower than $\frac{3}{8}$ ". Is this a problem? Or is this simply another confusing woodworking term (e.g., when 2x4s really don't measure 2" x 4"), and can I be assured that the jig will fit my saw?

Brint Keyes
via the internet

Since you are a beginning woodworker, I'll give you both an answer and some other thoughts on table saws. The depth of the slot on your saw may not matter, but the width sure will. As shipped from the factory, the guide bar on the tenoning jig just won't fit in the slot. Your best bet is to remove the bar from your saw's miter gauge and see if you can mill a few holes in it to attach it to the tenoning jig. You also can make a wooden guide bar for the commercial jig.

But let me pose another question. Why invest in rather expensive jigs? There are lots of ways to cut tenons without them, and I don't mean by hand.

Also, lots of folks start woodworking with a benchtop table saw and quickly run afoul of their limitations. Unfortunately, you should get a different table saw. If you haven't already, you will outgrow the benchtop saw soon. Take the money you would have spent on the jigs, combine that with what you can get from selling your benchtop saw, and buy a 1½-horsepower contractor style saw that's equipped with an induction (not universal) type motor. You'll use it for years and enjoy your woodworking more. It's unlikely you'll ever outgrow it. You can buy a contractor-style saw for little more than \$300, better ones for about \$700. Trust me, this isn't about tool snobbery, just the facts of woodworking.

— Steve Shanesy, editor and publisher

Bird's-Mouth Router Bits



Bird's-mouth 6 or 12

Bird's-mouth 16

Bird's-mouth 8

A bird's-mouth joint (traditionally used in making masts, booms and spars) vastly simplifies making multi-sided items such as columns, buckets and planters – in both tapered and parallel-sided forms. **\$26.50 each**

To see a selection of project ideas and tips on how to use these bits, visit our Web site and look at our 14-page instruction booklet for this product.

1-800-871-8158 or customerservice@leevalley.com

Shipping and N.Y. sales tax extra.

Lee Valley & Veritas®

Lee Valley Tools Ltd., 12 East River St., Ogdensburg, N.Y. 13669

Shop online:

www.leevalley.com

Can You Thin Water-based Polyurethane?

In reference to the technique of thinning polyurethane with mineral spirits and wiping it on with a rag, do you know if that will work with water-based poly as well?

Ralph L Hardison
via the internet

I'm sure your question arises from contributor Scott Phillips' comments about his favorite finish technique, applying oil-based polyurethane with a rag after thinning with mineral spirits at

a ratio of three parts mineral spirits to one part polyurethane. We asked our finishing expert and contributing editor Bob Flexner for his advice:

"You can thin it with water. The problem with doing this is that you reach a point where there aren't enough emulsifiers to combine the added water with the resin, and the finish separates or beads. Brands are different. You just have to try different mixture ratios. If it works, great. If the finish separates, thin with less water until it works. The first coat will probably be fine no matter how much you thin it because it soaks into the wood. It's the next coats that will separate if there's too much water."

Should I be Worried About My Tabletop Warping?

I want to build a kitchen table using 3/4"-thick oak. The dimensions are not final (about 36" x 96"). Can I make this size tabletop by edge-gluing boards without a big concern of warpage? Should I put cross pieces on the bottom to keep it from warping?

Rob Doty
via the internet

There are concerns, but if you've done your prep work correctly you should be in good shape. First, use quartersawn lumber, which has less risk of cupping and warping. Make sure the wood is dried correctly by checking the moisture content (around 7 percent is preferred). If you have the opportunity, run the boards to thickness and allow them to sit for a day or so. If any of them warp, set them aside in your scrap pile. Lastly, remember to attach the top in a way to allow the wood to expand and contract during changes in humidity. (For more information on this subject, see Lonnie Bird's article in this issue regarding wood movement.)

— David Thiel, senior editor

Why Oval Holes to Attach a Top?

In the \$175 Workbench (February 2001, issue #120) you attached the bench's top to the base through cleats. Why did you make the screw holes in the cleats oval shaped?

Ralph Knox
via the internet

The top expands and contracts more than 1/8" a year. The oval-shaped holes prevent the screws from snapping as the top moves. PW

— Christopher Schwarz, senior editor

WOODLINE ARIZONA, INC. OFFERS YOU MORE... Super Sets AT Great Prices!!!

30-Piece Professional Set



SUPER SPECIAL BUY

Includes:
5 Straight bits
3 Dovetails
3 Core Box
3 Cove Bits
6 Roundovers
2 Flush Trim
1 Panel Bit
2 Roman Ogee
2 Slot Cutters
1 "V" Groove
1 Chamfer
1 Bevel Trim Bit

WL-2010 **OUR PRICE ONLY \$109 set**

15-Piece 1/2" Shank Set



Includes:
Chamfer
Cove –
1/2"R, 3/8"R, 1/4"R
Roundover –
1/2"R, 3/8"R, 1/4"R
Roman Ogee –
1/4"R
Straight Bits –
3/4"R, 1/2"R, 1/4"R
Roundover –
1/2"R, 3/8"R, 1/4"R
1/2" Dovetail
1/2" Roundover
1"CL Flush Trim
Rabbit Bit

WL-2022
OUR PRICE ONLY \$59 set

15-Piece 1/4" Shank Set
same as WL-2022 except 1/4" shank

WL-2022 **OUR PRICE ONLY \$59 set**

5-Piece Cabinet Door Set **A \$279 VALUE**



Includes:
3/4" Bore Shaper Cutter
1-pc Rail & Stile (Roman Ogee)
4 5/8" Panel Raiser (Ogee)
Door Lip
Glue Joint
Drawer Locker

WL-1505 **OUR PRICE ONLY \$179 set**

6-Piece Cabinet Door Set



Includes:
2-pc Rail & Stile (Roman Ogee)
2 3/4" D Panel Raiser (Ogee)
Door Lip
Glue Joint
Drawer Locker

WL-2020 **OUR PRICE ONLY \$119 set**

8-Piece Classical Set **A \$150 VALUE**



Includes:
2 Classical – 5/32"R & 1/4"R, 1 Wavy
2 Ogee – 5/32"R & 1/4"R, 1 Filet
2 Roman Ogee – 5/32"R & 1/4"R
(1/2" Shank Router Bits)

WL-2016 **OUR PRICE ONLY \$99 set**

5-Piece Cove Set



1/2" Shank Router Bits
1/4"R, 3/8"R, 1/2"R,
5/8"R, 3/4"R

WL-2015 **OUR PRICE ONLY \$49 set**

5-Piece Roundnose (Core Box) Set



1/2" Shank Router Bits
3/8"D, 1/2"D, 3/4"D, 1"D, 1 1/2"D

WL-2012
OUR PRICE ONLY \$49 set

13-Piece Dovetail Set **A \$115 VALUE**



1/2" Shank Router Bits
3 Straight bits
10 Dovetail bits

WL-2014 **OUR PRICE ONLY \$49 set**

6-Piece Bullnose Set



1/2" Shank Router Bits
1/4"D, 3/8"D, 1/2"D,
5/8"D, 3/4"D, 1"D

WL-2013 **OUR PRICE ONLY \$89 set**

3-Piece Cabinet Door Set **A \$100 VALUE**



1/2" Shank Router Bits
2-Piece Roman Ogee Rail & Stile
2 3/4" Ogee Panel Raiser

WL-2019 **OUR PRICE ONLY \$65 set**

5-Piece Moulding Set



1/2" Shank Router Bits

WL-2011 **OUR PRICE ONLY \$99 set**

All Woodline Arizona Sets are packaged in a beautiful wood box (a \$10.00 value).

5-Piece Carbide-Tipped Forstner Bit Set



3/8" Shank for Drill Press
35mm, 1 1/4", 1", 3/4", 5/8"

WL-2018 **OUR PRICE ONLY \$39 set**

5-Piece Dovetail Set



1/2" Shank Router Bits
8" – 1/2"
14" – 3/8", 1/2", 5/8", 3/4"

WL-2017 **OUR PRICE ONLY \$19 set**

WOODLINE ARIZONA, Inc.
P.O. Box 1530 • Payson, AZ 85547
Great Router Bits & Shaper Cutters!
Best Selection...Best Price

Order Toll Free
1-800-472-6950

Most items in stock • All major credit cards accepted
Same-day shipping!! • Shipping \$3.75/\$100 + \$4.75

WOODLINE's Quality Bits and Cutters feature:
• Tough Micro-Grain Carbide
• Euro Anti-Kickback Design
• Super-slick Non-stick finish
• **Super Low Prices**

Check our website for new products:
www.woodbits.com
E-mail:
cuttersaz@cybertrails.com

When It Comes To DH Kilns,

**There's
Only
One
Original.**

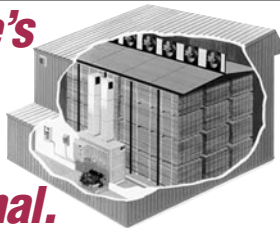

Kilns from 300 to 350,000 BF

Drying your own lumber is easy and profitable with an energy efficient Nyle kiln. They cost less to install and deliver superior quality over conventional steam kilns.

Nyle DH Kilns

Use 50% to 60% less energy than conventional kilns

Provide outstanding drying performance

Give you unbeatable quality and reliability

When you want to add value to wood, you want to work with Nyle. For more information about the benefits of Nyle DH Systems, go to www.nyle.com.



P.O. Box 1107 Bangor, Maine 04402-1107
1-800-777-6953 (207) 989-4335
FAX (207) 989-1101 www.nyle.com

Circle #129 on Reader Service Reply Card

TRICKS OF THE TRADE

Illustrations by John McCormick

Introducing the Plunge Trimmer for Inlay

THE WINNER:

Turn your Dremel or other moto tool into a plunge trimmer using shop scraps and some off-the-rack hardware. I built mine with an adjustable compass point in the base so I can rout semi-circular recesses for inlay. (Editor's note: see the stringing on the "Inlay Door With a Router" for an example of this). The backbone of the tool is a piece of wood $\frac{3}{4}$ " x $3\frac{1}{2}$ " x 9". To make the channel that the plunging mechanism rides in, glue and screw $\frac{1}{8}$ " x 2" x 9" strips to the edges of the backbone. Then glue $\frac{1}{2}$ " x $\frac{1}{2}$ " x $8\frac{1}{4}$ " strips to the inside of the $\frac{1}{8}$ " strips. The plunging mechanism is an "L"-shape. One wing of the "L" ($\frac{3}{4}$ " x $3\frac{1}{2}$ " x $3\frac{1}{2}$ ") holds the Dremel, the other rides in the channel. The Dremel is held in place in a $1\frac{1}{8}$ " hole lined with a piece of leather. The Dremel is held fast by cutting a kerf in the wing that intersects the hole for the Dremel. Then drill a hole through the wing and insert a 4" stove bolt and put a wing nut on the end. Tighten the wing nut, and the bolt closes the kerf. Like a plunge router, you need a return spring to lift the tool out of a cut. Rout a groove through the backbone. Screw one end of a spring to the backbone and the other to the plunging mechanism, which is attached through your groove.

The depth stop is a piece of wood that rides in the channel and is held in place by a wing nut and bolt that also ride in the groove in the backbone.

Finally, make the adjustable compass by first routing a $\frac{5}{8}$ " x $\frac{5}{8}$ " groove in the $\frac{3}{4}$ " x $3\frac{1}{2}$ " x 5" base). Rout a groove through a piece of wood $\frac{1}{2}$ " x $\frac{5}{8}$ " x 3". Drive a brad through one end as a pivot point. Attach the compass to the base with a flat-head screw.

William Adsit
Milford, Illinois

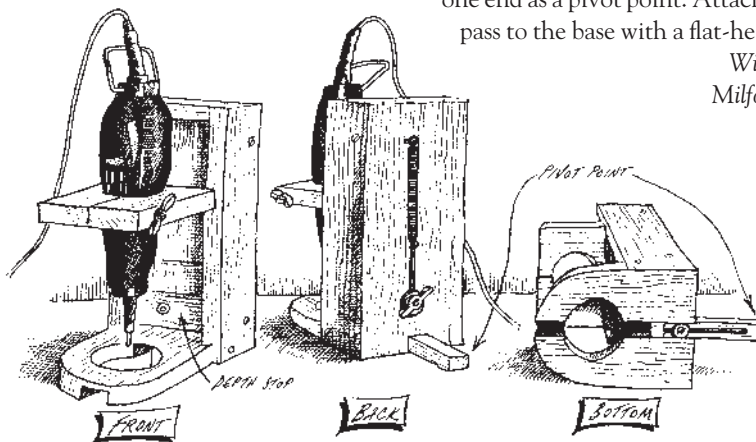

CASH AND PRIZES FOR YOUR TRICKS AND TIPS!

Each issue we publish woodworking tips and tricks from our readers that we think are useful. We want to encourage you to share with your fellow woodworkers, as well as reward the most useful and original concepts. Delta has agreed to lend us a hand with that, and the author of this issue's winning trick receives the new 22-580 two-speed portable thickness finisher (shown at left). The other trick's authors receive \$75.



To submit your tip or trick, e-mail it along with a daytime phone number to david.thiel@fwpubs.com or mail it to: Tricks of the Trade • Popular Woodworking 1507 Dana Ave. Cincinnati, OH 45207.



Adams Wood Products™
LTD., L.P.

CUSTOM COMPONENTS MADE TO YOUR SPECIFICATIONS

WE WILL MAKE PRODUCTION RUNS OF YOUR PART -OR- YOU CAN ORDER FROM OUR CATALOG OF STOCK ITEMS

CHAIR LEGS
ACR08
AMD08

913 LEGS

BUN LEGS
A0556

FR STYLE QUEEN ANNE LEGS

Made In Tennessee

FINIALS
A0851

113 REEDED BASE W/206 LEG

404 CHAIR KITS

P.O. Box 728, Dept. PW16
Morristown, TN 37815-0728
Phone 423-587-2942 • Fax 423-586-2188
www.adamswoodproducts.com

FREE COLOR CATALOG

Circle #100 on Reader Service Reply Card

Add Dust Collection and a Handy Shelf to Your Contractor Saw With Scraps

Here is a simple solution to two issues: the need for a convenient place to put the rip fence and miter gauge when not being used (as well as push sticks, featherboards, etc.), and a way to close off the underside of a contractor table saw to provide a surface to mount a dust port. I used a piece of $\frac{3}{4}$ " medium-density fiberboard (MDF) cut to 32" x 24". Unbolt the saw from the stand and raise it about 1" using sawhorses and shims. Slide the MDF between the saw and the stand and mark the location of the mounting holes through the stand. Remove the MDF and drill slightly oversized mounting holes at the marked locations. Cut a hole for the dust collection port at this time. Now slide the MDF in place and bolt the saw to the stand. Longer mounting bolts may be necessary. Fasten $\frac{1}{4}$ " x 1" strips to the edge of the MDF to provide a lip to help prevent items from sliding off. Finally, screw the dust collection port to the underside of the MDF.

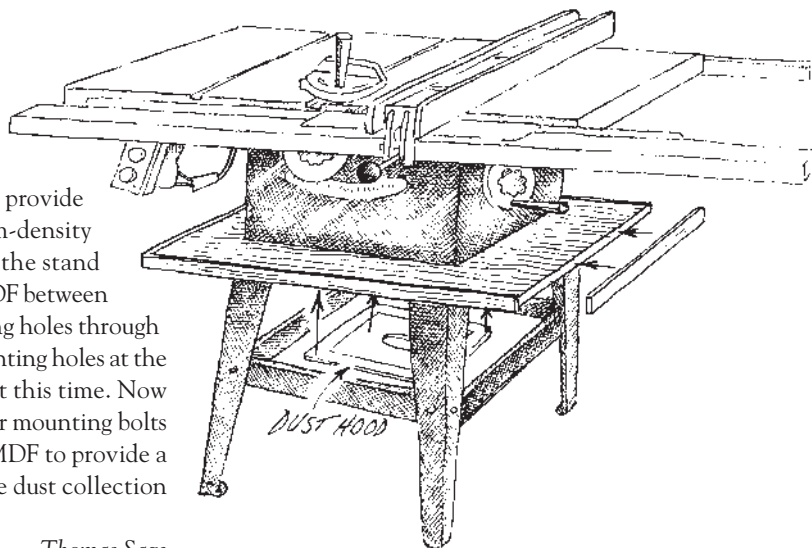

Thomas Sage
Waukegan, Illinois

Even Better Homemade Wood Putty

I make my own wood putty by emptying my sanding bag into a container. When I am ready to fill the holes, I mix sanding sealer with the sawdust. Here's how: Pour some sealer into a small container — just the amount you think you'll need to fill the holes — then add sawdust until you have a nice wood filler consistency. Stir the sawdust into the sealer until it is well mixed. Use some compressed air to blow out the spaces to be filled so they are clean of any dust and the filler will adhere well. I use a Teflon putty knife to compress

the putty into the holes so the wood isn't marred. Let it dry, then sand it and apply the same sealer to your whole project. The nice thing about this filler is you don't have to worry about different shades, it's real wood and it doesn't make any difference if the sealer spreads over the hole because you're going to use the same sealer to complete the project anyway.

Terry Campbell
El Cajon, California

Paper is the Key to Paper-Thin Shavings With Your Bench Plane

I've always had a real tough time adjusting the blade on my small bench plane so it's square to the mouth. Setting the blade depth and keeping it parallel to the mouth was always a challenge. I came up with a simple way to fix the problem for free. First loosen the blade enough to easily adjust it. Place the sole of the plane on a flat surface. Slide two pieces of paper under the sole. One in front of the mouth; one behind it. Gently apply a small amount of downward pressure on the blade. Put the cap iron in place and tighten. The blade will be square to the mouth and the depth of cut will be close to where it should be. **PW**

Arnie Frand
Mesa, Arizona

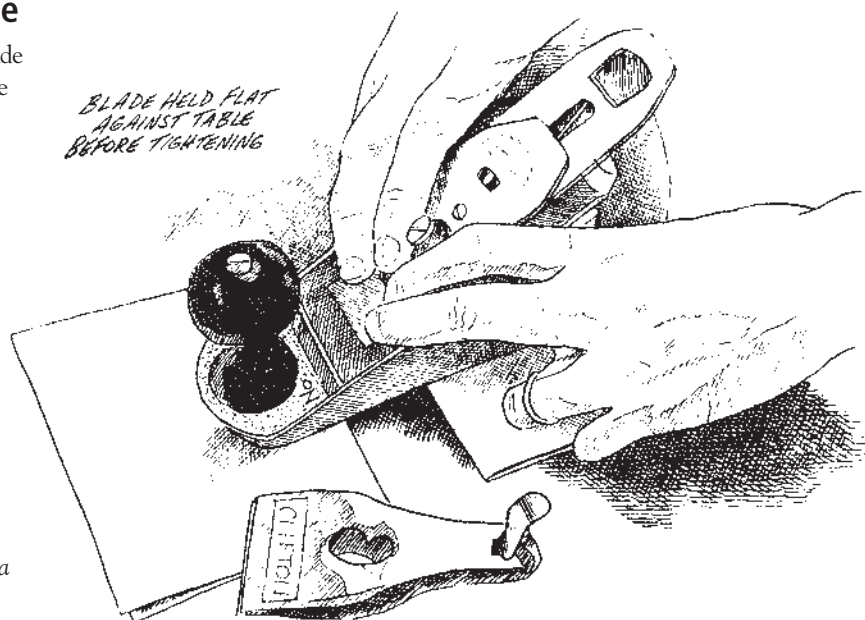

The Newest and Best Sanders from Makita

We've rated Makita's BO5010 palm grip random orbit sander our favorite model for a couple years now, so when company officials said they had a couple of new random-orbit models, we were all ears. We weren't disappointed. Both the new in-line BO6030 and the right-angle BO6040 are impressive sanding tools.

The in-line BO6030 is designed as a fine finishing sander and performs well in that role. The 6" pad provides superior performance on larger surfaces, while the variable-speed control offers easily adjusted sanding aggressiveness.

The sander has low vibration during use and is remarkably quiet. The two-handle design with rubberized rear handle dampens vibration even further and makes the sander comfortable to use for long stretches. Though quiet, the 2.7-amp motor provides ample power to remove material at a moderate pace.

Dust is collected through the pad and trapped in a standard cloth dust bag, or the sander can be hooked directly to a vacuum for improved collection.

The larger right-angle BO6040 is another animal altogether. Where the 6030 seems a very refined but capable sander, the 6040 is an aggressive and powerful industrial-feeling tool with the highest amperage rating in its class (though it is still a quiet tool). Also with a 6" pad, the sander operates at a lower orbits-per-minute than the 6030, but it offers two operating modes. In the random-orbit mode the sander operates as a fine finishing sander. When switched (either on the fly, or while stopped) to the "random orbit with rotation mode," the tool steps down the pad speed to between 180 and 670 rpm and the sander removes material very aggressively. It also can be used for polishing

in this mode.

As with the 6030, the ergonomic design of the housing makes it pleasant to use and the tool has a rubberized palm grip for comfort. An optional side handle is available.

Dust collection on this unit is also through the pad. With both of these 6" units Makita has relocated the collection holes in the pad more toward the edges of the pad, where most of the dust is created. This proves to be a good strategy, though you need to buy new Makita sanding discs to take full advantage of the redesign. The pads do include a second set of six holes toward the center of the pad for other manufacturers' sandpaper.

On the 6040, the through-the-pad dust collection is designed to be used with a vacuum, and this system proved effective. Unfortunately, the sander is not sold with the dust collection connections and we had to use



BO6040

SPECIFICATIONS

Makita BO6030/BO6040

Street price: \$180/\$370

Motor: 2.7amp/6.6amp

OPM: 4K-10K/1.6K-5.8K

Orbit diameter: 1/8" 7/32"

Weight: 5.1 lbs./5.9 lbs.

Pad size: 6" /6"

Decibels @3': 88-90/89-98

Performance: BO6030 ●●●●○
BO6040 ●●●●●○

Value: BO6030 ●●●●○
BO6040 ●●●●○

Makita: 800-4-MAKITA, or
www.makitatools.com



BO6030

duct tape to hook up our vacuum for testing.

Both of these sanders are a pleasure to use and are strong performers. We would prefer that the right-angle model come complete with the dust collection attachments and the handle, though. In particular we found the BO6040 to be a powerful and impressive tool, and though priced higher than some right-angle models, it's not out of line for the sanding performance you get.

For more information, circle #152 on Reader Service Card.

HOW WE RATE TOOLS

At *Popular Woodworking* we test new tools and products with an honest, real-world workout. We check for ease of assembly and determine how clear and complete the manuals are. Then we use the tool in our shop to build projects that appear in the magazine. Each issue, the magazine's editorial staff shares its results and experiences with the tools, rating each for performance and value.

We use a one-to-five scale, with "five" in performance indicating that we consider it to be the leader in its category. For value, "five" means the tool is a great deal for the money, while "one" means we consider it pricey. However, a tool with a low value rating may be worth the high price.

If our tool reviews don't answer all your questions, e-mail me at david.thiel@fwpubs.com or call me at 513-531-2690, ext. 255. If we haven't reviewed the tool you're considering, there's a good chance I've used the tool, but simply haven't had a chance to write a review. Give me a call and see if I can help. You can also visit our website www.popwood.com to check out our past published tool reviews and sign up for our free e-mail newsletter (focusing on tools) that's sent out every other week. —David Thiel, senior editor

New DeWalt Brad Nailer Mixes Features with Style

DeWalt has branched into the world of air tools with a new line of compressors from Emglo and a full set of nail guns. We tested the D51238K 18-gauge brad nailer and were impressed with the tool's details. First off, it comes with cool safety glasses. OK, get over that and let's look at the tool. The skin is smartly designed with a moderate-weight, all-aluminum body and a glass-filled nylon magazine. There's an overmolded rubber grip for comfort. Out of the box, the nailer is set up for "bump-firing," which means that with the trigger depressed, the gun will fire every time the nose is pressed to your work. The tool comes with a sequential-fire trigger that is fairly easy to install.

We really like the depth-of-drive adjustment, which operates by pressing a release button and sliding a lever to another notch. It's the easiest depth adjustment we've seen, and there's even a scale so you'll always know where you are. Other features include an adjustable exhaust, visible reload indicator, tool-free nose door for clearing jams and a rear-mounted nose safety for better viewing and easier access to corners. DeWalt has entered the race with a good tool with smart options.

For more information, circle #153 on Reader Service Card.



SPECIFICATIONS

DeWalt D51238K

Street price: \$145
Brad sizes: 18 gauge, 5/8" - 2"
Magazine capacity: 110 brads
Trigger style: Bump or sequential
Weight: 2.8 lbs.
Performance: ●●●●○
Value: ●●○○○
DeWalt: 800-4DeWalt,
 or www.dewalt.com

Delta Offers the First Two-Speed Benchtop Planer

After reviewing all the benchtop planers a few issues ago we thought we'd seen everything in this category. Then Delta surprised us by showing us the new 22-580 13", two-speed planer/finisher. Delta calls it a planer/finisher because officials say the slower feed speed offers a planed surface that is near finished quality. I still think I'll do a little sanding, but it is a nice surface. Along with the obvious advantage of an improved surface finish offered by the slower speed and increased number of cuts-per-inch, the 22-580 has all the finer features available on today's new planers: a head lock for reduced snipe, a full-range depth stop across the entire height range, a zero indicator for setting the planer up for the first pass and a well-located and easily read material removal scale.

The 22-580 also makes blade changes a snap, with removable upper covers for easy access, on-board tools and locating pins for adjustment-free installation. This is a well-equipped and versatile planer that is priced a little high, but offers a lot for the money. **PW**



For more information, circle #154 on Reader Service Card.

SPECIFICATIONS

Delta 22-580

Street price: \$450
Max material width: 13"
Table size: 13" x 35"
Weight: 97 lbs.
Blades: two double-edged disposable, .062" x 1/2"
Feed rates: slow speed gives 90 cuts per inch at 14.8 feet per minute; fast speed gives 60 cuts per inch at 22.4 feet per minute
dB no load/load: 92/96
Amps, no load: 7.3
Amps, load: 8.3
RPM, no load: 9,766
RPM, load (fast/slow): 6,734/7,181
Lateral blade adjustment: 1/8"
Performance: ●●●●●
Value: ●●○○○
Delta: 800-438-2486,
 www.deltawoodworking.com

TOOL SCOOP

New Cutting Gauge is Extremely Precise



In the world of marking wood, a cutting gauge beats the pants off a marking gauge everyday. Instead of scratching the wood with a pin, the gauge's wheel slices your mark and is less likely to follow the grain. Glen-Drake Toolworks has now vastly improved on standard cutting gauge designs and made the tool easier to adjust and use.

The Tite-Mark gauge has two spring-loaded locking knobs instead of one. The rearmost knob locks the head where you want it. Then you fine tune your setting by turning the knurled barrel and lock that setting in with the front knob. All these operations can be done with one hand. This well-manufactured tool surpassed every expectation. Of course, quality has a price. The Tite-Mark costs \$79 plus shipping.

For information on ordering, phone 707-961-1569 or visit www.glen-drake.com. The Tite-Mark is also available from Lie-Nielsen Toolworks 800-327-2520.

Arrow Brad Nailers

In our 2002 Tool Buying Guide we offered information and advice on buying 18-gauge brad nailers. But we were being a little myopic, thinking only in terms of pneumatic brad nailers. So to correct that oversight we're happy to include information here about two electric 18-gauge brad nailers from Arrow. The ET100 is a 10-amp tool firing three nail sizes (5/8", 3/4" and 1") priced at around \$40. The ET125 (shown) is a 14-amp tool firing four nail sizes (5/8", 3/4", 1" and 1 1/4") priced at around \$115.

Features on both tools include non-slip cushioned grips, solid state circuitry and both a trigger and nose safety. For information visit www.arrowfastener.com.



Ridgid EB4424 Oscillating Belt/Spindle Sander

This unique tool sands both curves and flat areas.

When the Ridgid line of woodworking tools was introduced three years ago, we were aware of how Ridgid's parent company (Emerson Electric) had made tools for Craftsman for years. So we were anxious to see the new line. Of the many innovations in the Ridgid tool line, the EB4424 caught our eye. It's a sanding machine with two heads. One head is a traditional round spindle that oscillates up and down (shown in the photo). The other head is more like a 4" belt sander turned on its side. It also oscillates. After testing the unit for more than two years, we've made a permanent place for it in our shop. Here's why.

To be honest, the specifications of this combination unit aren't as good as that on a large stand-alone oscillating spindle sander or an edge-sanding machine. The oscillation stroke (up and down) is slightly shorter than average, and the belt surface capacity is significantly less than on most edge sanders.

But having both functions in one unit for under \$250 makes great sense for a home woodworker. Two independent units would cost more than \$600. Add to that the fact that the edge sander also oscillates and you've improved not only the sanding ability, but by not running pieces over the same spot on the belt, the sandpaper lasts longer. Belt tracking adjustment on the sander is fairly easy and holds track well. Changing the belt itself is also user friendly.

The table tilts easily to four preset angles, or it can be locked down anywhere within a 45° arc. The preset detents can be adjusted to square them perfectly. The table itself is of good cast aluminum construction and offers a groove for use with a miter gauge.

Ease of changing from spindle to edge sander is a matter of unscrewing one knob and trading out the sanding heads. The drive



Photo by Al Parrish.

spindle must be aligned properly in the edge sanding unit, but once in place it's no problem. The spindle sander also comes with four throat plates to accommodate the different spindle sizes and is also a quick change. New sandpaper sleeves can be slipped over the rubber drums with little fuss.

One of the primary concerns in either a spindle or edge sander is retaining a square relationship to the table. In testing, the drive shaft flexed at the top of the spindle in either mode. This flex may be about 1/16" and occurs under significant pressure. That said, we haven't noticed the flex adversely affecting the performance of the tool.

Though provided with a dust collection port, we found that dust removal was far from perfect and required cleaning during heavy use. But it is sanding and we should expect some dust.

We continue to enjoy using this tool in our shop. It isn't what we would recommend for a production cabinet shop, but the performance and versatility for the price makes it a strong option for the home workshop. **PW**

— David Thiel

SPECIFICATIONS

Ridgid EB4424 Oscillating Belt/Spindle Sander

Street price: \$239

Motor: 4.6 amp induction (3/8 hp)

RPM: 1,725

Oscillations per minute: 60

Stroke length: 3/4"

Drum length: 4 1/2"

Table stops: 45°, 30°, 22 1/2°, 15°

Dust port: 2 1/2"

Spindles: 1/2", 3/4", 1", 1 1/2", 2"

Weight: 39 lbs.

Belt size: 4" x 24"

Nice features: Tilting table, easy changeover between sanding modes, great value for combined abilities.

Recommended modifications: Improve rigidity of drive spindle to reduce flex, increase available work surface in edge-sanding mode.

Available at: Home Depot. Ridgid: 800-4RIDGID or www.ridgidwoodworking.com

ABOUT OUR ENDURANCE TESTS Every tool featured in our Endurance Test column has survived at least two years of heavy use in our shop here at *Popular Woodworking*.

ECON
 FILM TO BE
 SCANNED AND PLACED
 AT PRINTER

Circle #120 on Reader Service Reply Card

www.osbornewood.com
OSBORNE Wood Products, Inc.

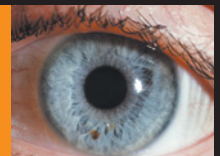

We've got an eye...for Table Legs

We have Table Legs . . . and plenty of them. From simple to ornate, from dainty to robust, we just might have what you're looking for in Pine, Maple, Oak, or Cherry. And if we don't, we can custom-make table legs to your specifications!



8116 Highway 123 North • Toccoa, GA 30577
 Call for a catalog: 1-800-746-3233 • 706-886-1065
 Order line: 1-800-849-8876 • Español: 1-877-445-6034

Circle #110 on Reader Service Reply Card

WOODWORKERS BEWARE!
 Your blades are in danger!

The **WIZARD** line of metal detectors can help prevent costly planer, jointer, and saw blade damage from nails, screws, or other metal hidden inside your lumber. Designed especially for woodworkers, all include a 1 year warranty.



Little Wizard \$19.95*

- Economical
- 2" scanning coil
- Effective to 2" deep



Lumber Wizard \$99.95*

- 6" scanning coil
- Faster Scanning
- Effective to 4" deep
- Vibration Alert - Allows use in noisy workshops



Wood Scan Wizard \$139.95*

- Fastest Scanning
- Scan up to 6"x12"x any length
- Scan all 4 sides of lumber at once
- Effective to 4" deep
- Use hand-held or in benchtop stand



Call to find a dealer near you,
 or visit us on the web:

WIZARD™ Detectors - 888-346-3826

<http://WizardDetectors.com>

*Recommended Retail Price

Dealer Inquiries Welcome!

Circle #132 on Reader Service Reply Card

Incra® Guaranteed Square & 45°
 Guaranteed is more than just our promise... it's our name!



No shop is complete without a good square. True, accurate squares, are typically hard to come by. Not any longer. Introducing Incra's new line of Guaranteed Squares & 45°'s.

- Guaranteed .001" accuracy
- Rigid, one-piece blade & body
- Beautiful anodized surfaces
- 1/4" alloy body, 3/4" alloy handle

NEW

Woodpeckers Inc.
 Precision Router Tables & Accessories
 1.800.752.0725 • www.woodpeck.com

	Introductory pricing	Reg.	SALE
5" Square	5 1/2" x 4"	\$42.95	\$39.95
7" Square	7 7/8" x 5 1/2"	\$52.95	\$49.95
5" 45°	5 1/2" x 4"	\$42.95	\$39.95
7" 45°	7 7/8" x 4"	\$52.95	\$49.95

Circle #135 on Reader Service Reply Card

Clamp Assist

Simple solutions to three perplexing assembly problems.

Most woodworkers operate under the theory that you can't have too many clamps and stock them by the dozens, even the hundreds. I'm one of those, I admit. My clamp inventory takes up a whole corner of my shop — when my shop is straightened up, that is. On most days, my clamp collection is spread out over the entire shop so I can enjoy it properly.

For all my clamps, however, I frequently run across assembly tasks that I can't do properly with store-bought clamping equipment alone. For these tasks, I've developed several simple "clamp assists" that extend the capabilities of ordinary clamps to help accomplish extraordinary clamping jobs.

Holding Assembled Parts Square

When assembling projects, you frequently need to hold the parts square to one another. Miter clamps have their place, but they aren't as versatile or as easy to use as corner squares. These simple jigs are triangular pieces of plywood with cleats along the edges at right angles to one another. You clamp the cleats to the parts you are assembling and the corner squares hold them at 90°.

To make the corner squares, first cut right triangles from 3/4"-inch plywood. Note that I put a little notch in the right corner. When you glue the parts together, sometimes a little glue squeezes out of the joint. The notch prevents the glue from sticking the jig to the assembly. Attach cleats to the right sides, then trim the cleats on a table saw to make sure the outside edges are precisely 90° from one another.

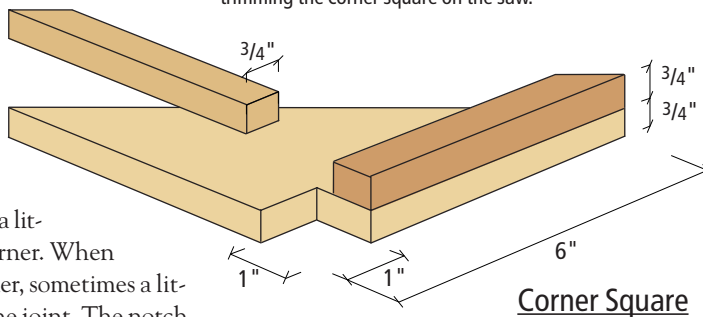

When using the corner squares, clamp the cleats to the parts of the assembly. You can make fine adjustments by loosening a clamp until it's just snug and tapping the clamped part with a mallet until it shifts a fraction of an inch. At right, I'm trimming the corner square on the saw.



Photo by Al Parrish.

Illustrations by Mary Jane Favorite.



PriceCutter.com
 "THE WOODWORKER'S BEST VALUE"

1-888-288-2487
www.pricecutter.com

P.O. Box 1100 - Chardon, OH 44024

Save up to 87% Off DeWalt's Original List Prices

All Bits Carbide Tipped

30 Degree Raised Panel Bit

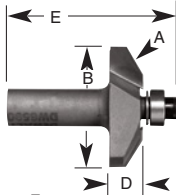

ITEM #	A LARGE DIA.	B CUTTING LENGTH	C SHANK SIZE	E OVERALL LENGTH	LIST	SALE PRICE
D6590	1 5/8"	7/16"	1/2"	2 3/8"	\$55.72	\$19.99

2-Piece Stile & Rail Bit Set

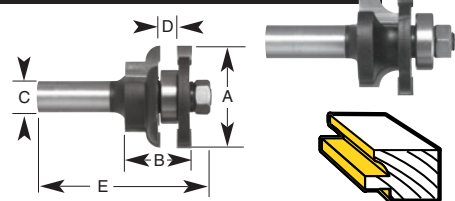

ITEM #	A LRG. RAD.	B CUT. DIA.	C CUT. LGTH	D SHANK SIZE	E GROOVE WIDTH	OVERALL LGTH	SALE PRICE
D6489*	1/4"	1 5/8"	1 1/16"	1/2"	1/4"	2 7/8"	\$49.99
D6950	Replacement Groover						5.99

* with black oxide coating

Rounding Over Bowl Bit

A solid surface undermount bowl bit with a round over profile.

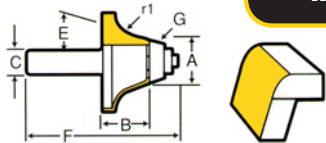

ITEM #	A BEARING RAD.	B CUT. DIA.	C LGTH	E SHANK DIA.	F OVERALL LGTH	G BEARING ANGLE	LIST	SALE PRICE
D6762	17/32"	7/8"	1"	1/2"	18"	3"	\$72.54	\$19.99

Ogee Bowl Bit

A solid surface undermount bowl bit with a decorative ogee detail.

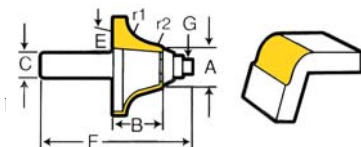

ITEM #	R1 RAD.	R2 RAD.	A LG. DIA.	B CUT. LGTH	C SHANK SIZE	E ANGLE	F OVERALL LGTH	G BEARING DEGREE	LIST	SALE PRICE
D6756	17/32"	13/64"	7/8"	1"	1/2"	18°	3"	10°	\$109.46	\$19.99

Bevel Undermount Bit

ITEM #	A BEARING DIA.	B CUT. LGTH.	C SHANK SIZE	E ANGLE	F OVERALL LENGTH	G BEARING DEGREE	LIST	SALE PRICE
D6768	7/8"	1"	1/2"	12°	3 3/8"	10°	\$42.86	\$19.99

SOLID SURFACE BITS



ROUTER BIT STORAGE CASES

Made of durable high density polyethylene. Double wall lid with protective foam lining. Slotted die cut foam insert for bits with a 1/8" shank or smaller.

ITEM #	Was	NOW
A A5144 Small Storage case (holds up to 30 bits)	\$29.99	\$19.99
B A5145 Large Storage Case (holds up to 70 bits)	39.99	29.99

BRASS ROUTER INLAY KIT

Make perfect fit inlays & repairs. Includes solid carbide 1/8" down-cut spiral bit, bushing, retainer nut, snap on brass collar & instructions. Fits any router that accepts a 1 3/8" two piece template guide bushing.

Reg. \$29.99
Now \$19.99
 #A5051



Straight Bits

Single Flute

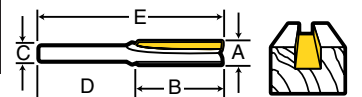

ITEM #	CUT. DIA.	CUT. LGTH	A SHANK SIZE	B SHANK LGTH	C OVERALL LGTH	D LIST	E SALE PRICE
D6103	3/4"	3/4"	1/4"	1"	2"	\$15.50	\$4.59
D6405*	3/4"	1"	1/4"	1"	2 1/4"	17.74	4.99
D6104	3/4"	1"	1/4"	1"	2 1/4"	16.80	4.99
D6142	3/8"	1"	1/2"	1"	2 1/2"	22.50	4.99
D6144	1/2"	1 1/4"	1/2"	1 1/4"	2 3/4"	24.30	6.99

* with black oxide coating

Slotting Cutters

Two Wing Assemblies
 1/4" shank

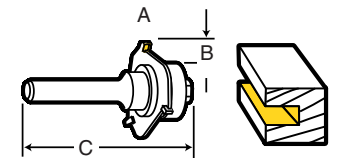

ITEM #	A KERF	B CUTTING LENGTH	OVERALL LENGTH	LIST	SALE PRICE
D6812	1/16"	1/2"	2 5/16"	\$27.30	\$9.99
D6814	3/16"	1/2"	2 5/16"	28.34	9.99
D6816	1/4"	1/2"	2 5/16"	28.34	9.99
D6491*	1/4"	1/2"	2 5/16"	29.92	9.99

* with black oxide coating

Panel Pilot Bit

ITEM #	A CUTTING DIA.	B CUTTING LENGTH	C SHANK SIZE	D SHANK LENGTH	E OVERALL LENGTH	LIST	SALE PRICE
D6458	1/2"	1 1/16"	1/2"	1 1/4"	3 1/2"	\$48.26	\$8.99

Beading Bits

ITEM #	A RAD.	B LARGE DIA.	C CUTTING LGTH	D SHANK SIZE	E OVERALL LGTH	LIST	SALE PRICE
D6500	3/8"	7/8"	1/2"	1/4"	1 1/8"	\$43.10	\$9.99
D6444*	3/8"	7/8"	1/2"	1/4"	1 1/8"	45.48	10.49
D6446	3/8"	1 1/8"	3/8"	1/4"	2"	45.36	10.99
D6506	3/8"	1 1/4"	5/8"	1/4"	2 1/8"	46.96	11.99

* with black oxide coating



For the crowned bars to work properly, the assembly must rest on a flat, rigid surface such as a workbench. Be careful not to over-tighten the clamps. If the middle of a bar lifts off the assembly, the clamps are too tight.

a frame or a box square to one another while the glue dries. I have even used them to hold large boards — too large to fit in a vise — while I worked the ends or edges.

Clamping Face-to-Face

Occasionally, I need to clamp two boards face to face. This is a simple chore when the boards are narrow, but it becomes more difficult as the boards grow wider. Even deep-throated clamps have a limited capacity that may not reach to the center of wide boards. Consequently you won't get an even clamping pressure all across the width, and the assembly will be weak in the center. You run into a similar problem when trying to attach veneer or marquetry to a wide panel. How do you clamp the center area?

For years, I solved the problem by keeping a

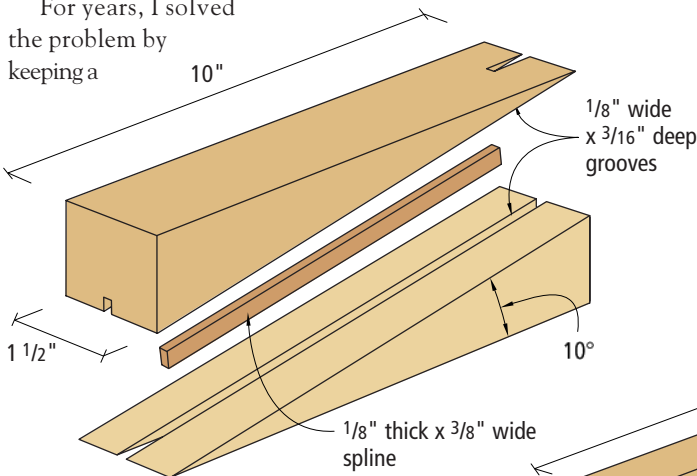

Grooved Wedges

stack of concrete blocks outside the shop. When I needed pressure in the center of a wide assembly, I stacked blocks on it. It works, but it's inconvenient and somewhat limited.

A better solution is to make a set of crowned bars. These are hardwood bars, 24" to 36" long, with one convex edge. This edge is

Grooved wedges are useful not only for putting projects together but also for taking them apart. Here I'm using the wedges to pop the joints of a wobbly chair as I prepare to restore it.

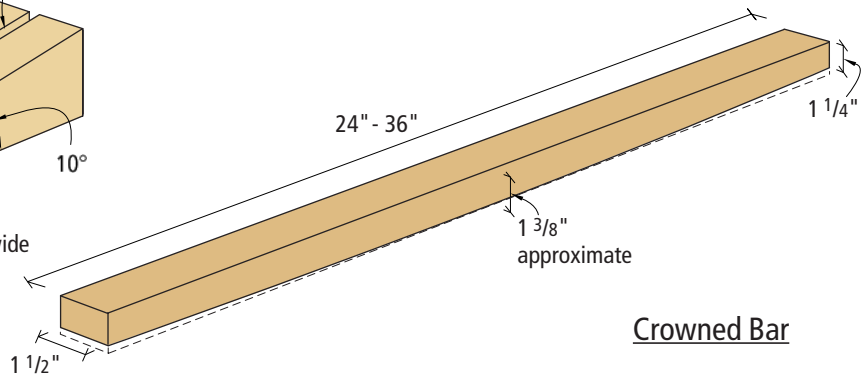

Crowned Bar

crowned only slightly, about $\frac{1}{16}$ " to $\frac{1}{8}$ " wider in the center than it is at the ends. I cut a crown by raising the outfeed table of my jointer a few thousandths of an inch above the knives and jointing the edge. You can also create a crown with a band saw, hand plane or a disc sander.

To use the crowned bars, lay the assem-

bly on a flat workbench and lay the bars across the assembly with the crowned edge down. (I label the opposite edge with the word "Up" to help me orient the bars properly.) Then clamp the ends of the bars to the workbench. The bars will flex slightly, evenly distributing the pressure from the middle out to the edges of the assembly.

Applying Tension

Clamps are designed, by and large, to generate compression to squeeze two boards together. But every now and then, you need some tension either to pull an assembled joint apart or to clamp a part inside a larger assembly. When I need a little tension, I rely on a set of grooved wedges.

I cut the wedges from a hardwood with a slope of about 10°. If the slope is any steep-

er than that, you run the risk of the wedges slipping when you use them. Make grooves in the sloping edges by cutting shallow saw kerfs down the center. Finally, make a spline to fit the kerfs. The spline should be as thick as the kerf is wide and twice as wide as the kerf is deep.

To use the wedges, position them slope-to-slope with the spline in the grooves. Use a bar clamp to slide the wedges together so each wedge climbs the other's slope. As this happens, the outside edges of the wedges will push against the parts of the assembly, applying tension. **PW**

Nick Engler is the author of over 50 books on woodworking, plus countless articles and project plans. Currently, he's helping kids across America to build ribs for a full-size replica of the first true airplane, the 1903 Wright Flyer.

CENTENNIAL FLYER UPDATE

The ribs of the 1903 Centennial Flyer continue to come in from all over the world — one from as far away as Singapore! Once again, many thanks to the volunteers who are running the rib-building workshops and helping hundreds of young people all over this continent — and beyond — to participate in this once-in-a-lifetime project.

The Wright Brothers Aeroplane Co. took a short hiatus from constructing the 1903 Flyer in September and October to travel to Kitty Hawk, North Carolina, and fly our replica of the 1901 Wright Glider that we just completed. We had some very good winds and made some surprisingly decent flights, although we found as the Wright brothers did that the 1901 glider design was lacking in lift and control.

While we were on the Carolina Outerbanks, we worked with two Wright "re-actors," Tom Cherry (Wilbur) and David Thompson (Orville) to recreate scenes from the Wright brothers' work for a PBS documentary scheduled for release during the Centennial of Flight in 2003. Both Tom and Dave were delighted to hear news of our Centennial Flyer, and we invited them to attend our unveiling. You can see Tom and Dave flying the 1901 glider on our web site at www.wright-brothers.org.



Tom Cherry and David Thompson measure the lift of the 1901 Wright Glider, recreating one of the Wright brothers' experiments.

FREE!

WOODWORKING CATALOG



Go to
rockler.com/go/v1383
and order your
FREE catalog today!
Or call
1-800-403-9736

Check out our complete
EXCLUSIVE line of jigs
and shop tables for your
band saw, drill press and
router. **PLUS** thousands of
other great products!

ROCKLER®

WOODWORKING AND HARDWARE

Code 11505

The NEW name for... The NEW name for... The NEW name for... Woodworkers' Store

ByPhone

ByFoot

ByNet

1-800-403-9736 1-877-ROCKLER www.rockler.com

Circle #112 on Reader Service Reply Card

NIAGARA LUMBER

You'll appreciate our difference.

Prepaid Freight • Surfaced • Bundled
Shrink Wrapped • Guaranteed

- All lumber is Select and better grade, 4" and wider, averaging 6"-7" in width, lengths are 6'-8'. All stock meets or exceeds National Hardwood Lumber Assoc. grade rules.
- All domestic lumber is Northern Appalachian grown, exhibiting characteristics of fine grain, texture and uniform color.

Visa/Mastercard/Discover accepted.

Niagara Lumber & WOOD PRODUCTS, INC.

47 Elm Street • East Aurora, NY 14052
Call Toll-Free 1-800-274-0397
www.niagaralumber.com

Circle #143 on Reader Service Reply Card

West Penn HARDWOODS, INC.

Satisfaction Guaranteed • No Minimum Orders
Quarter-Sawn White Oak • High Figure Curly Maple

Now Also Exotic Species:

Bloodwood, Bubinga, Jatoba, Spanish Cedar Padauk,
Purpleheart, Zebrawood and more

NEW: European Steamed Beech

ALL CREDIT CARDS ACCEPTED

Call for free catalog and pricing.
TOLL FREE (888) 636-WOOD (9663)

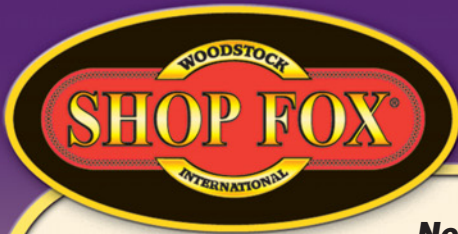

INNOVATIVE PRODUCTS

QUALITY MACHINES DESIGNED FOR PRACTICAL USE

New, from the maker of the famous Shop Fox® Mobile Bases and Table Saw Fences is this partial line-up of fine woodworking machines. Whether it is the patented oscillating drum sanding feature on the drill press or the patent pending mortising machine, Shop Fox® machines are designed for exceptional value.

SEE THESE FINE MACHINES AT A DEALER NEAR YOU!

OSCILLATING DRILL PRESS

- ◆ MOTOR: ¾ H.P.
110V, 1725 R.P.M.
- ◆ OVERALL HEIGHT: 38"
- ◆ SPINDLE TRAVEL: 3¼"
- ◆ SWING: 13¼"
- ◆ DRILL CHUCK: 5/8"
- ◆ TABLE: ROUND 12¾" DIA.
- ◆ 12 SPEEDS: 250-3050 R.P.M.
- ◆ WARRANTY: 2 YEARS
- ◆ WEIGHT: 115 LBS.

Standard Drill Press Mode converts to quick-change Oscillation Spindle Sander in seconds!

W1668
SHOP FOX®
Oscillating Drill Press



*Includes DRUM SANDER SET
The patented oscillating feature moves the spindle up and down while rotating.*

MORTISING MACHINE

- ◆ MOTOR: ¾ H.P., 3450 R.P.M.
- ◆ ADJUSTABLE DEPTH STOP ROD
- ◆ UNIQUE SWIVELING BASE

PATENT PENDING

- ◆ HYDRAULIC CYLINDER FOR SOFTER RELEASES
- ◆ 6" x 16" WOOD TABLE
- ◆ MORTISE TO THE CENTER OF A 8" WIDE BOARD
- ◆ MORTISE LUMBER TO 8¾" THICK
- ◆ HEAVY CAST IRON CONSTRUCTION
- ◆ WARRANTY: 2 YEARS
- ◆ WEIGHT: 90 LBS.

W1671
SHOP FOX®
Mortising Machine

The unique SWIVELING BASE allows easy off the bench operations and opens new possibilities for custom mortises.

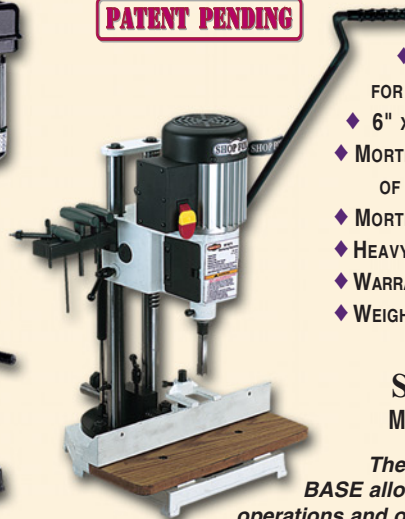

2 H.P. DUST COLLECTOR

- ◆ MOTOR SIZE: 2 H.P., 110/220V, SINGLE-PHASE, 3450 R.P.M.
- ◆ MOTOR AMP DRAW: 18/9
- ◆ 5" INLET WITH A REMOVABLE "Y" FITTING WITH (2) 4" OPENINGS
- ◆ PORTABLE BASE SIZE: 21½" x 33½"
- ◆ BAG VOLUME: 5.4 CUBIC FEET
- ◆ HEIGHT (WITH BAGS INFLATED): 78"
- ◆ BAG SIZE (DIA. X DEPTH): 19" x 33" (2)
- ◆ AIR SUCTION CAPACITY: 1550 C.F.M.
- ◆ STATIC PRESSURE: 12.3"
- ◆ STANDARD BAG FILTRATION: 30 MICRON
- ◆ WARRANTY: 2 YEARS
- ◆ WEIGHT: 130 LBS.

W1666
SHOP FOX®
2 H.P. Dust Collector

Shop Fox® is a Registered Trademark of Woodstock International, Inc.

Features the patent pending QUICK BLADE TENSION LEVER

16" BANDSAW

- ◆ MOTOR SIZE: 1½ H.P. 110/220V
- ◆ MAX. CUTTING WIDTH: 15½"
- ◆ MAX. CUTTING HEIGHT: 8½"
- ◆ TABLE SIZE: 16" x 16"
- ◆ TABLE HEIGHT: 42"
- ◆ BLADE SIZE RANGE: ¼" - 1¼"
- ◆ BLADE LENGTH: 115"
- ◆ BLADE SPEEDS: 2300/3300 F.P.M.
- ◆ WARRANTY: 2 YEARS
- ◆ WEIGHT: 250 LBS.

W1673
SHOP FOX®
16" Bandsaw



364101958R

*Available from quality dealers
around the country*

1-800-840-8420

sales@woodstockint.com • www.woodstockinternational.com

WOODSTOCK
INTERNATIONAL INC.



Circle #125 on Reader Service Reply Card

Kelly Mehler: Table Saw Whiz in the Bluegrass State

Scott Phillips, host of TV's 'American Woodshop,' visits Mehler's shop and finds — of all things — an automotive showroom filled with table saws.



Photo by Christopher Schwarz.

Kelly Mehler: Best known for his landmark "The Table Saw Book," first published in 1993, Mehler also is a frequent lecturer on The Woodworking Shows circuit and an instructor at the Marc Adams School of Woodworking. Mehler works only with solid wood and is known for his grain-matching talents.

The lifeline of Berea, Ky., is Chestnut Street. It takes every visitor to the heart of Berea College. This school has been teaching progressive concepts for over a century, programs to keep inspired individuals prospering. This atmosphere touches everyone in Berea, or maybe the people of Berea just are independently unique. Either way, Kelly Mehler's shop on Chestnut Street fits this place like a glove.

Mehler's first passion is custom woodworking. But on the side he finds time to au-

thor books, articles and videos, teach classes at Marc Adams School of Woodworking, give seminars at The Woodworking Shows, and to host many workshops across America every year.

The first thing that is striking about his place is that Mehler converted a vintage automotive dealership into his wood shop. Aged brick walls frame huge banks of windows that light up his shop. Years ago, cars probably occupied every inch of both the showroom and the "garage." Today air-dry-

ing wood fills that space, and its aroma makes all woodworkers feel right at home.

When I walked through the 24"-wide door into the garage-turned-woodshop I got a little envious. Natural light from the southern exposure streamed in on his vintage machines. Fifteen-foot-high, well-insulated ceilings lift the eyes to explore every nook and cranny.

His shop space totals about 3,000 square feet. This includes a small entrance showroom that features graceful furniture accented by beautifully figured wood that Mehler builds from select logs. When asked to describe his design style, he smiles because most folks see a unique furniture form.

It all is solid, beautifully selected and matched-grain native woods that blend the best of Shaker, traditional and contemporary forms. Mehler says he buys rare logs, then has them sawn so he can use matching boards for every piece he makes. He says he air-dries most of his own lumber because of the rich colors this technique produces. After more than 30 years in the business he has amassed a small fortune in special wood. But don't even think about offering to buy some of it. My guess is that in the back of his mind he has plans for every board.

Mehler's latest project is updating his well-known "The Table Saw Book" (Taunton Press), so his shop is temporarily loaded with about every table saw on earth. It was interesting to see "all" table saws at once. It reminded me that most saws are copies of a few basic designs.

So which saw does he like for the home woodworker? Mehler says he's kind of partial to the new DeWalt DW746. Mostly, though, Mehler warns woodworkers away from buying a saw based only on price.

"We spend \$2,000 on a computer that lasts about five or six years," he says. "Yet

AMERICAN WOODSHOPS

often we try to pinch pennies when we buy tools that last a lifetime.”

I couldn't agree more. Spend the extra dollars for quality, and you'll always be happy. Just don't tell everyone at home about your purchase. And get rid of the box before you take it home. Wives are cagey about empty, expensive-looking packaging. Don't tell anyone I told you this.

When Mehler is done with all of these saws, you can bet he'll stick with his 5-horsepower Austrian-made Felder combination machine (they cost between \$5,000 and \$15,000 and can be set up to do just about every machining job in a wood shop). It occupies the center of the shop and maybe Mehler's heart.

Another interesting part of Mehler's shop is his vintage heavy-duty machinery that he has purchased wisely (and inexpensively) over many years and after a little horse trading. I covet his 36" 1910 Oliver band saw, which he uses primarily for resawing. His 24" Crescent planer looks as big as the rock of Gibraltar. It also was interesting to see that his dust collection system ducts directly out-



side to minimize shop cleanup time and maximize woodworking time. His industrial-grade spray booth is tucked in a far corner behind his clamp rack.

Perhaps his favorite "tool" is his German-style European workbench that looks loaded with great stories. This well-worn bench is where Mehler uses hand tools to cut dovetails, fit joints, and make the wood just about sing.

Everywhere you look you'll see that this



Mehler's band of heavy-metal machines includes this massive planer. My only question is: Where is its mobile base?

Photos by David Thiel.

man has carefully grown his shop with just the right tools for his needs. So passionate is Mehler about tools that he's lately been getting involved in the debate about safety and guards in the U.S. market. Mehler consults for many different companies regarding shop safety and design. He is a member of an Underwriters Laboratories Inc. advisory council and focuses on improving power tool safety.

It's The World's Only Cordless Brad Nailer That's Also Pneumatic.

Cordless. Pneumatic. Our new cordless brad nailer gives you the option of both, using exclusive **TPS Technology™** (Twin Power Source System). It's cordless, thanks to a mini-compressor powered by our rechargeable, interchangeable 12-volt battery. It's also pneumatic, courtesy of a 1/4" valve that allows you to use it with traditional compressors. To get one of your own, visit your Porter-Cable dealer or call 1-800-487-8665 (519-836-2840 in Canada).



PORTER-CABLE
PROFESSIONAL POWER TOOLS

When asked what is the most important piece of safety equipment on a table saw, the splitter comes to the top of Mehler's list. Why? Because, he maintains, the splitter reduces the risk of a kickback dramatically. He also says that European manufacturers can teach American companies many great ideas on improving tool guards.

For example, he showed me how the Felder table saw's splitter actually was designed to move up and down with the saw blade. The splitter can be used for non-through groove and shoulder cuts because of this feature — again, minimizing the risk of kickback. Also, European guards on jointers make it hard to even get your hands near the cutterhead while jointing a board. The guard is positioned to make a woodworker raise his or her hand over the danger zone. Very smart design! And by the way, Mehler practices what he preaches. Even his old 12" Oliver jointer was set up with a great guard.

Mehler's portfolio of furniture is extensive, and it's obvious he specializes in matching and coordinating the grain in a piece of furniture. When I visited, Mehler was



Mehler (center) demonstrates his Felder combination machine. It's amazing how the splitter moves up and down with the blade. Why can't we have this on all U.S.- and Taiwanese-made saws?

working on a tiger maple chest, a rift-sawn red oak hope or blanket chest (with hand-cut dovetails) and a large case-on-case piece.

He probably works 60 hours a week and clearly loves what he does. I bet if he had to just do one thing it would be to teach woodworking to as many folks as possible. If you have an opportunity to work with him, don't pass it up. You will find your time well spent with this American master. **PW**

—Scott Phillips, contributing editor



AMERICAN WOODSHOPS

Woodworkers love to see the shops of other woodworkers. And few people see as many amazing shops as Scott Phillips, host of

PBS' "The American Woodshop." Every issue, Phillips takes us inside the shops of some of the finest craftsmen (and women) in America. You can see more about Kelly Mehler's shop by tuning in to "The American Woodshop" on your local PBS affiliate in spring 2002. Check your local listings for airtimes and dates.

It's The World's Only Pneumatic Brad Nailer That's Also Cordless.



Pneumatic. Cordless. Our new cordless brad nailer gives you the option of both, using exclusive **TPS Technology™** (Twin Power Source System).

It's pneumatic, courtesy of a 1/4" valve that allows you to use it with traditional compressors. It's also cordless, thanks to a mini-compressor powered by our rechargeable, interchangeable 12-volt battery. To get one of your own, visit your

Porter-Cable dealer or call 1-800-487-8665 (519-836-2840 in Canada).

Proud sponsor of
THE NEW YANKEE
WORKSHOP on
Public Television



PORTER-CABLE
PROFESSIONAL POWER TOOLS

WWW.PORTER-CABLE.COM

Circle #116 on Reader Service Reply Card

classic shaker CANDLESTAND

While this is one of the most traditional furniture forms, building one of these small tables is not all that complicated.

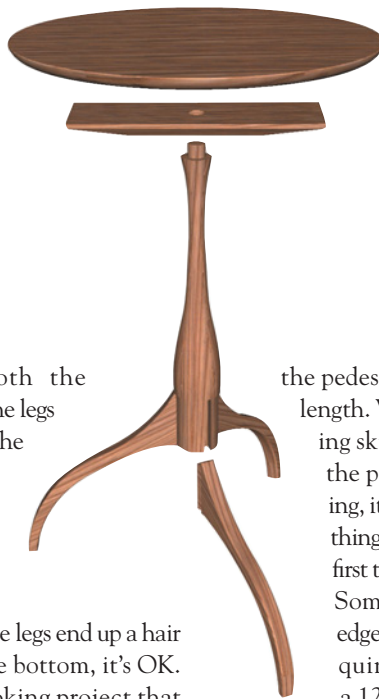

Built by members of the Mount Lebanon community in New York during the first half of the 19th century, this recognizable Shaker form is actually their stylish interpretation of earlier forms. The legs are a derivation of a Sheraton design. The Shakers referred to the leg design as “umbrella” or “spider feet.” I first found this table in John Kassay’s “The Book of Shaker Furniture.” The original shown in the book is part of the J.J.G. McCue collection, and resides in the Museum of Fine Arts in Boston. A very similar cherry table is also in the collection of the Metropolitan Museum of Art in New York City.

Forgiving Form

While I’ve included detailed pat-

terns for both the pedestal and the legs on this table, the form is actually forgiving. If your turning ends up a little thinner in one area, or the legs end up a hair thinner at the bottom, it’s OK. It’s a nice-looking project that will allow you to practice your skills and end up with a great-looking table.

Everything about the table connects to the pedestal, so let’s begin there. I’ve included a pattern that gives the diameter of

the pedestal all along its length. While the turning skills required for the piece aren’t taxing, it also isn’t something to attempt your first time at the lathe. Some basic knowledge of turning is required. Start with a 12/4 maple turning blank that is about 20" long. Turn the entire piece to round, finishing out at about 2 7/8". That is the largest diameter dimension used on the pattern, but if you end up with less than that, adjust the rest of the

dimensions to match that difference. Turn the rest of the pedestal according to the pattern, leaving a 1"-diameter x 3/4"-long stub on both ends.

When you’re done with the pedestal, the next step is to cut the three sliding dovetail grooves for the legs on the base of the pedestal. The legs are oriented at 120° around the base of the pedestal. You need to mark the locations accurately, but to cut the grooves themselves I’ve borrowed from a few different books to make a router jig that makes it nearly foolproof. The jig is made from shop scraps and holds the two stubs of the pedestal in place and uses a screw to hold the pedestal oriented correctly to cut each groove. Use two different bits to cut the grooves. Start with

by Malcolm Huey

Malcolm Huey has been building reproductions and adaptations of 18th and 19th century furniture for more than 30 years. His company, Malcolm L. Huey & Sons, is located in Middletown, Ohio.





Turning the pedestal is a great way to practice your lathe skills. While there is a pattern to follow, the lines are fluid enough to allow for personalization, slight miscalculations or both.

a $\frac{1}{2}$ " straight bit to remove most of the wood, then follow up with an 8° dovetail bit. Stop the groove at the shoulder, $3\frac{1}{2}$ " up from the base of the pedestal.

The next step is to rough out the legs by milling three pieces to $\frac{7}{8}$ " x 4" x 15". Then use the provided scaled pattern to lay out the shape of the legs in pencil on the pieces. Make sure the grain runs the length of the leg, or your legs could snap. Determine the location of the dovetail pin on each leg and cut the corner from the leg blank at that point. Before shaping the rest of the leg, it's eas-

ier to cut the dovetail pin first.

Set up your dovetail bit in a router table. Attach an auxiliary fence to allow you to hold the leg upright against the fence. Run a test piece on some scrap to see if your offset is correct. You want the fit to be tight at this point. You'll hand-fit each joint later. When the test piece fits to your satisfaction, run each side of the leg past the bit, shaping the pins.

With this important joint complete on all three leg pieces, head for the band saw and rough cut the legs to shape. Then use a spindle sander (or spokeshave) and



The dovetailing jig makes it fairly simple to place the leg, run the groove, then rotate the leg to the next position. Note the screw in the diagram and photo that's used to hold the pedestal in the appropriate position.



finish shaping the legs to finished size. On the original Shaker piece, the legs are also tapered slightly in thickness down to the feet. You can achieve this authentic look with a bench plane and some care.

The next step is to fit each leg to the pedestal. I re-use part of my router jig as a stop on my bench to hold the pedestal in place while I carefully pare away material with a chisel until each leg slides in

place with a snug fit.

Once satisfied, trim the lower stub off the pedestal, finish sand the legs and post, and glue the legs in place. If your joint is well-made, you shouldn't need any

SHAKER CANDLESTAND

NO.	ITEM	DIMENSIONS (INCHES)			MATERIAL
		T	W	L	
□ 1	Top	$\frac{3}{4}$	$19\frac{7}{8}$ dia.		Maple
□ 1	Mounting plate	$\frac{3}{4}$	5	$13\frac{3}{4}$	Maple
□ 3	Legs	$\frac{7}{8}$	$3\frac{9}{16}$	$14\frac{5}{8}$	Maple
□ 1	Pedestal	3 dia.	20		Maple
□ 4	Wood screws	#9	$1\frac{1}{4}$	FH	Steel

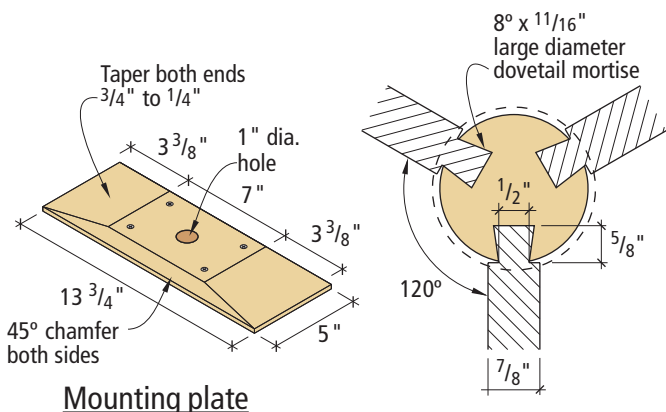

Mounting plate

Leg to pedestal dovetails



To cut the mating pins for the sliding dovetails, a router table works best. By using an auxiliary fence clamped above the table, first one side of the leg is run (left), then the leg is turned around and the opposite side is run (right).

Router Jig for Leg

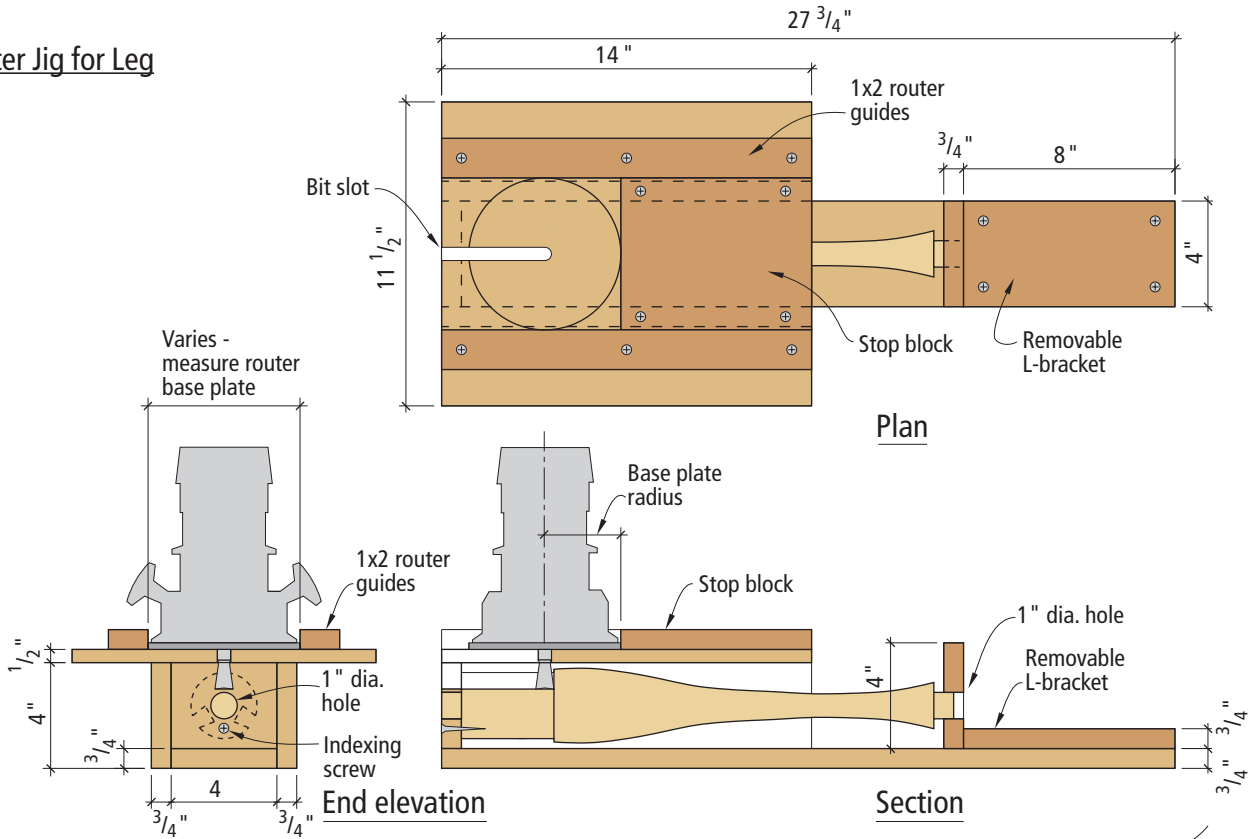

clamping pressure. The Shakers used metal plates across the base of the pedestal to hold the legs in place, but our glues are more reliable. Allow the glue to cure and move on to the top.

You now have a table base. The last two parts are actually the easiest. If you can find a piece of maple that is 20" wide, use it for the top. That's what the Shakers did, and it looks great. If you can't find a board that wide, look for a thicker piece, cut it



The leg shape is created by making a full-size template from the included scaled pattern, then transferring that to the leg blanks. A band saw makes quick work of the roughed-out shapes.

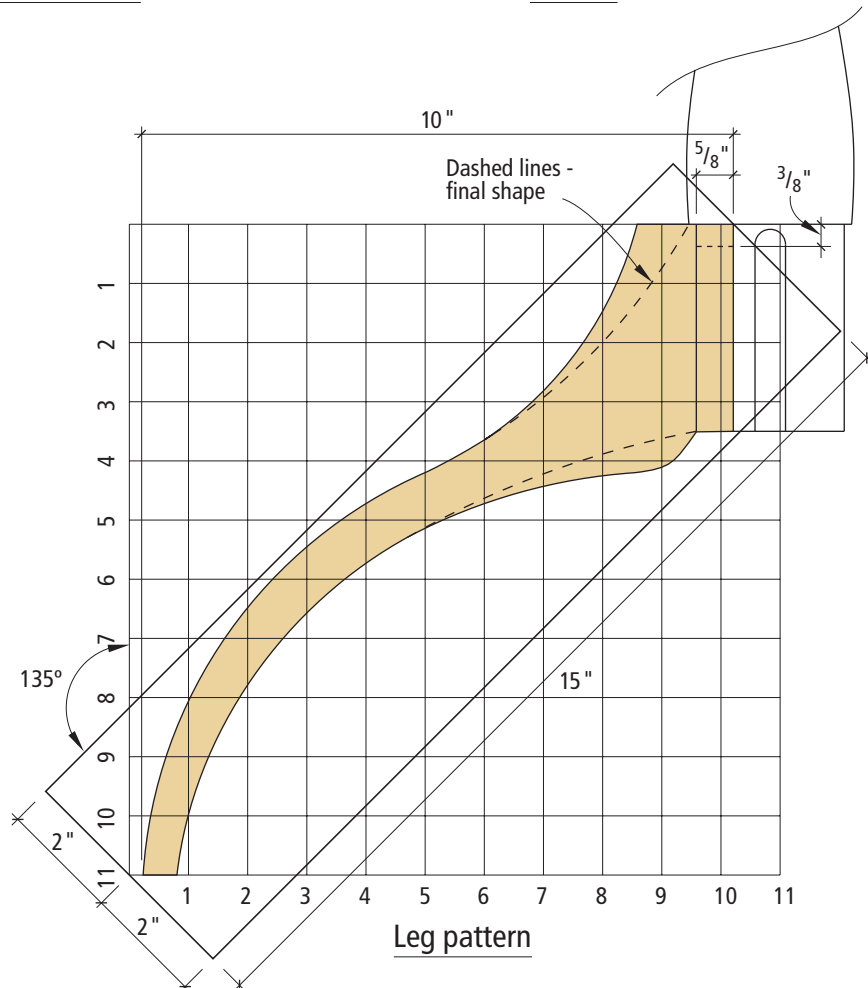



A spindle sander makes what could be a daunting task reasonably painless. By using double-sided tape to hold the legs together, all three can be sanded at the same time, reducing work and ensuring uniform shapes.

in half along the width on your band saw and make the top book-matched. While you're scrounging for wood, grab a piece that's 5" x 13³/₄" to use as the mounting plate.

To shape the top, I use a simple circle-cutting jig that mounts to my router. With the center of the jig attached to the underside of the top, cut the 19³/₈"-diameter shape using a spiral bit, taking the cut in three or four passes. When the top is round, chuck a 1/2" roundover bit in your router and round over the bottom edge of the top. Then do the same to the top edge with a 1/16" roundover bit (or break the edge with sandpaper).

The mounting plate is simple,



No matter how accurate your machining, there needs to be some hand-fitting to make the legs just right. A sharp chisel can make a big difference here. Don't make the joint too tight, but not too loose, either.



A circle-cutting jig attached to my router lets me make a true circle. Take increasingly deeper passes around the perimeter of the top to complete the cut.

except that to keep it like the original, both ends of the plate taper to 1/4" thick within the first 3³/₈" of each end. There are a couple of ways to do this, but I still think the safest way is to use a band saw to cut the taper, then use a sander to clean up the surface.

With the plate tapered, cut a 3/16" roundover on all four edges and drill a 1"-diameter hole in the center of the plate. Then drill a few more mounting holes for attaching the top. You're now ready to finish sand the piece.

It's a good idea to drill clearance holes in the mounting plate before gluing the mounting plate to the base. It screws on much easier the second time.

To attach the base to the mounting plate, cut a saw kerf across the width of the top stub on the pedestal, running the kerf with the grain. Slip the mounting plate over the top of the stub, then add glue and drive a wedge into the saw kerf to lock the plate in place. When the glue is dry, cut the tenon and stub flush to the top of the mounting plate.

All that's left is to attach the top and add the finish. I use a water-based aniline dye made by Moser that's available from Woodworker's Supply (800-645-9292). Traditionally, in my shop we dilute the dye more than the

manufacturer recommends. Be sure to make some sample boards to find a color that you like. Next, I follow that with a couple coats of orange shellac. I level that with 360-grit sandpaper and then apply a brown glazing stain over the shellac. After I allow that to dry overnight, a few coats of lacquer finish the job. **PW**

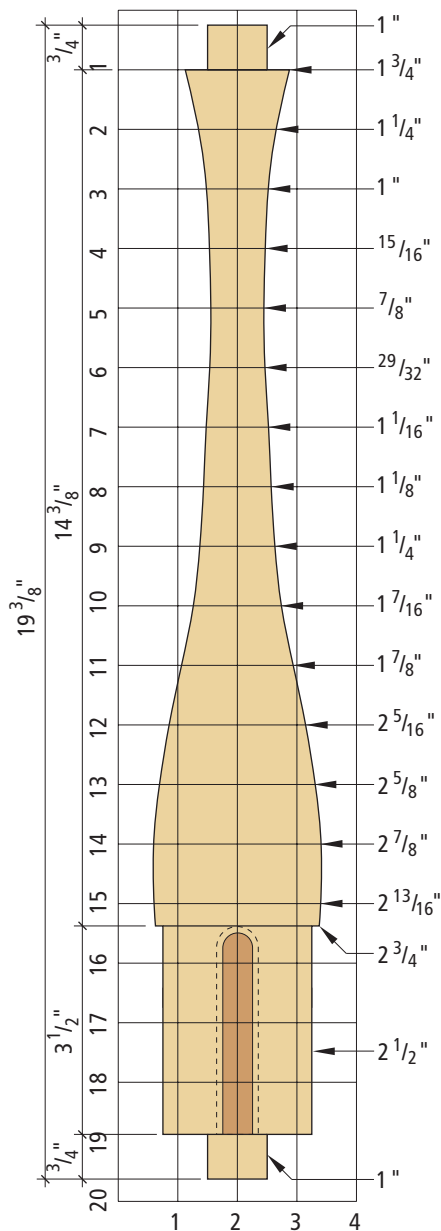

Pedestal turning & dovetail mortise



FREE CATALOG

Klockit Offers You:

- Our New Fall Catalog which Features 175 New Products!
- Factory Direct Pricing
- Finished Clocks
- Clock Motors & Inserts
- Clock Replacement Parts
- Highest Quality Wood
- Atomic Time Products
- Guaranteed Satisfaction



**FREE*
CATALOG!**

Mention OFFER, PW102
* Foreign \$5

www.klockit.com

Internet Exclusive Products!
Listen to Mechanical & Music Movements!

1-800-KLOCKIT that's 556-2548

Circle #108 on Reader Service Reply Card

Hardware with HEFT



Art Deco
Coat Hook
\$2.50

Attractive
and Sturdy
Lag Hook
\$6.50

Card Frame
\$1.75

Elegant and
Detailed Web
Bracket \$8.50

Scroll
Handrail
Bracket
\$6.50

These lost-wax cast-steel reproductions of antique and Art Deco styling have wonderful detail and substance. You will not find hardware of this heft and appeal anywhere else at these prices.

To see the thousands of hardware items in our collection, please visit our Web site or contact us to request our free 144-page full-color hardware catalog:

1-800-871-8158 or customerservice@leevalley.com

Lee Valley & Veritas[®]

Lee Valley Tools Ltd., 12 East River St., Ogdensburg, N.Y. 13669

Shipping and N.Y. sales tax extra.

Shop online:

www.leevalley.com



Quality is more affordable than you think!
BRIDGEWOOD[®]



TSC-10C Table Saw-

with features such as a large working surface, powerful American made motor and sturdy construction you'll see we didn't spare quality to make an economical table saw

- Miter gauge with T-slot groove • Cast iron extension wings
- Magnetic switch • Quick release plug connection on motor
- 4" dust collection hook up • Large 27" x 40" table
- Beveled front table edge for smooth miter gauge operation
- 1 1/2 HP American made motor
- Comes with VEGA[®] U-26 fence (shown)

BW-6R Jointer

Acclaimed a "best buy" among 6" Jointers by a professional woodworking publication

- 3-knife cutterhead • Jackscrew knife adjustment
- New fence tilts both ways, quick and easy adjustment.
- 3 positive stops • Enclosed stand • 1 HP motor • Rabbeting table and ledge • Surface ground tables • Pushbutton switch
- Cast iron wheels



BW-15BS Bandsaw-

don't let its low price fool you, this amazing bandsaw is designed and built to provide trouble free operation cut after cut.

- Heavily ribbed, cast iron c-frame
- Cast aluminum wheels with rubber tires
- Non-rocking steel floor stand
- Miter gauge • Motor mounted directly to cast iron frame for smooth operation
- 3/4 HP motor
- Two blade speeds: 2000 or 2600 SFM



BW-15P Planer

economically priced yet built like big professional planers, it offers absolutely vibration free finishes

- 3 HP motor • 3 v-belt drive from motor to cutterhead • Table moves up and down - cutterhead stationary for smoother cuts
- Sturdy 4 leg non-rocking stand • Extended stock support rollers • Anti-kickback fingers across entire width • 3 spring chip breaker
- Heavy cast iron construction • Magnetic switch • Jackscrew knife adjustment



BW-002A

Dust Collector

portable, compact unit can solve your dust collection problems at a very low cost

- FEATURES: Metal impeller (not plastic) • Two HP, single phase motor • Bag attached with quick release metal straps • 1059 CFM • 43.5 gal. collection bag • One 5" or two 4" dia. hose inlets • 1 micron filter bag

QUALITY MACHINERY • PARTS • SERVICE • GREAT LEASE PLANS

WILKE
MACHINERY COMPANY
MACHINERY POWER TOOLS

For information and a FREE catalog

contact us by toll free phone:

1-800-235-2100

visit our web page:

www.wilkemach.com

write or visit our showroom:

3230 N Susquehanna Trail, York, PA 17402-9716

Circle #131 on Reader Service Reply Card

THE ESSENTIAL GUIDE TO table saws

We test 9 popular contractor-style saws to find out who makes the finest machine. While we're at it, we also show you how to make difficult cuts easily and safely.



During a tool demonstration a while back our staff was honestly a little scared and concerned to see an “experienced” woodworker rip a board by standing to the side of the saw and pushing the board through sideways. We realized that while the manuals included with table saws give you basic

safety tips, the advice doesn't always sink in — sometimes with disastrous results.

For the new woodworker, it's imperative to learn the correct, safe way to use this dangerous ma-

chine — saws with a circular blade are the No. 1 cause of accidents in U.S. woodshops. For those who have been using table saws for years, it's best to stop and think about the way you're now using

the saw, rather than risk an injury.

Entire books have been written on setting up and using the table saw, so we can't tell you everything about using a saw here. But we will give you the basics on safety, and ripping and cross-cutting both plywood and solid wood. Once the basics are in place,

by David Thiel

Questions or comments? You can contact David at 513-531-2690 ext.255 or at david.thiel@fwpubs.com.

we encourage you to take a look at some of the books available to make sure you're getting the most out of your table saw.

Groan - Safety!

OK, no one wants to read a long discourse on table saw safety, but is your safety worth a couple of minutes? You bet it is. Let's start with a quick list of rules you should follow whenever you use your table saw.

1. Follow the setup instructions as described here, and from the manufacturer.
2. Set the blade to the proper height for each cut.
3. Stand in the proper place at the saw to provide support and to keep you safe.
4. Keep your fingers clear of the insert plate zone when the saw is operating. In fact we like to paint our inserts red (if they aren't already) to remind us where that zone is.
5. Keep scraps, tools and loose objects off the saw during operation.
6. Unplug the saw every time you change the blade.
7. Make sure that the insert plate and any table additions are level to the saw table surface. When your blade is spinning in the middle of a cut, it's a bad time to find your piece is hung up on something.
8. If you're ripping material less than 4" wide, use a push stick. Period.
9. No loose clothing or jewelry near the saw.
10. Work with help handy. If you get into trouble, can you call for assistance?

What about guards? OK, we'll admit that most guards provided with saws (a combination splitter/pawl/shield) meet the bare minimums to be called a guard.

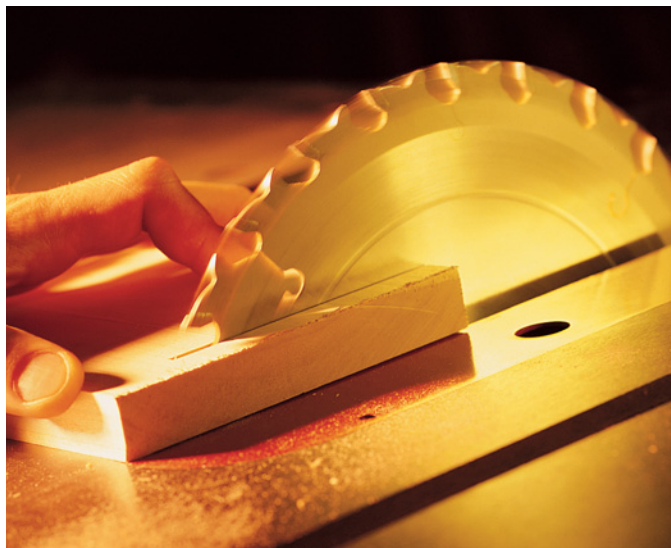

If this photo doesn't make your stomach turn a bit, you probably need to examine the way you use a saw. The blade is too high, the hands are too close to the blade. The wrong type of blade is installed and you never make a cut freehand.

Most combination guards are difficult to adjust and keep adjusted, and perhaps half of the cuts that can be made on a table saw can't be made with the factory guard in place. We know. But if you can use a guard during an operation, please do so. If you can afford to upgrade your saw to a more user-friendly aftermarket guard (see the "Getting Started" article on the next page) it's a great idea. In addition to guards, we feel strongly about using safety glasses, hearing protection, push sticks and splitters.

Before making your first cut on a new saw (or if it's been a while since you tuned up your saw) do these simple checks on the saw to make sure everything is ready to run. Check the blade for square to the tabletop. We keep a fairly inexpensive metal machinist's square near the saw at all times. When you first square the blade, the set screws are adjusted to allow you to return to square easily. But with use, this adjustment can change, and it should be checked periodically. Your owner's manual will show you how to adjust this setting.

You also need to check the blade and rip fence to make sure they are parallel to the miter gauge slots. Again, your owner's manual provides most of the information necessary for this step.

My dad, God bless him, used to have a saying in the shop, "It's carbide, it doesn't need sharpening yet!" Well, I think we all know that a sharp blade cuts more eas-

A good example of the right and wrong way to use a saw is what is known as the "invisible arrow." When cutting rabbets, the cut can be made two ways: the correct way is to make your first cut with the piece flat on the table, then make the second cut with the piece on edge. This allows the waste to fall to the outfeed side of the blade. If done in the opposite order, the waste piece becomes trapped between the blade and the fence and is launched at some 40 miles an hour. If you're standing in the wrong position behind the fence (like me in the photo at right) you can get a nasty surprise just a little south of the breadbasket. Knowing where to stand and the proper steps to cut a piece can make all the difference.



SOURCES

AFTERMARKET GUARDS

Excalibur/Sommerville, 800-357-4118
excalibur-tools.com

Biesemeyer, 800-782-1831
biesemeyer.com

ROLLER STANDS

Delta, 800-438-2486
deltawoodworking.com

Fisch, 724-663-9072
fisch-woodworking.com

HTC, 800-624-2027

Record, 937-382-3811
recordtool.com

Rousseau, 800-635-3416
rousseauco.com

Shop Fox, 360-734-3482
woodstockinternational.com

Triton, 888-874-8661
multi-stand.com

ily than a dull one. Make sure your blade is in good shape, and sharp, so you don't end up trying to force wood past it. That's a sure way to get hurt.

So you're ready to raise the blade and make a cut. But how high should you raise the blade? For the most efficient (and safest) cut, the blade should be about $\frac{1}{8}$ " to $\frac{1}{4}$ " higher than the thickness of the piece you're cutting. This allows the teeth to clear the cut (for more efficient performance) but keeps the blade low enough to be less of a hazard.

The proper place to stand while using your saw will depend on what cut you're making. We've outlined the basic "moves" later in the article. But in general, standing directly behind the blade is the more hazardous location.

Speaking of standing, there are a few operations on a table saw that benefit greatly from an extra pair of hands or roller stands. To be honest, while an extra pair of hands can be useful, it takes a skilled and knowledgeable pair of hands to assist, rather than hinder, during a cut. You're likely better off to look to any number of roller stands available on the market, or build an outfeed table that suits your type of woodworking.

Finally, before you do anything on the table saw, be rested, unhurried and think carefully about the cut before you make it. If something feels wrong or makes you nervous, there's probably a better (and safer) way to do it. Listen to the voices in your head and your gut, and you'll enjoy woodworking for many years to come.

GETTING STARTED—SAFETY AND ALIGNMENT



Beyond the stock guards provided with most table saws, more convenient and user-friendly aftermarket guards are available, but at some cost. The Excalibur overarm guard (left) allows the guard to be lifted away from the blade for "through" cuts impossible with a standard guard, though you're still limited in height. This guard should be used with a splitter/pawl attachment. The Biesemeyer version

(right) simply snaps into place and requires no tools for removal. An absolutely necessary safety tool is a push stick. Two homemade versions are shown at right. We generally prefer the "shoe" style (the one on top) for added support. You'll also note the homemade throat insert, providing zero clearance spacing around the blade. It's a must to stop small scraps from slipping through the plate and getting tossed back.

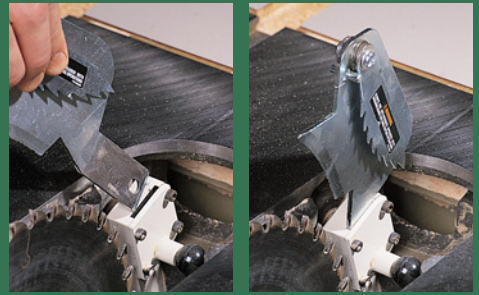

The first step in making sure your table saw is safe is to make sure the blade and fence are parallel to one another. (We'll assume you've already aligned the blade to the miter slot as instructed by your owner's manual.) Simply set the fence to any reasonable distance (9" in our photo, left) and check the distance between the fence and blade both at the front and rear of the blade. If the measurements are not equal, adjust your fence until correct. If this setup isn't done correctly, your material can become pinched between the fence and blade (or splitter/guard) and either violently be kicked back at you, or make it too hard to push the piece all the way through. If you have to force a piece through a cut, you're doing something wrong. If the fence is out of parallel in the other direction, you may not get hurt, but you'll have a hard time making square cuts.

When crosscutting narrow pieces on the table saw, you will eventually encounter the situation where the falloff pieces are small enough to not move out of the way on each cut, and they will begin to accumulate to the outfeed side of the blade. This doesn't automatically create a dangerous situation, but one of the pieces could be pushed against the outfeed side of the blade and be thrown back at you. Even with the guard in place, a piece can be small enough to be kicked around between the guard and blade, or tossed back. Optimally, you should stop the saw and wait until the blade has stopped spinning, then remove the offending chunks. More likely than not, it will be inconvenient to keep turning off the saw. In that case, stand out of the kickback line of fire and use a scrap piece of wood or your push stick to nudge the pieces out of the way (right). Don't use your fingers! You can always make a new push stick.



RIPPING A BOARD

1 Ripping a piece of solid lumber is simpler than ripping plywood, but there is more potential for danger because the stress in a solid wood board can pinch the blade when it is ripped. Roller stands are recommended (you can't see mine in the photos) and should be positioned to support both pieces coming off the saw. To start the cut, you should be positioned at the rear corner of the board as in the photo, supporting the back end with your right hand. Your left hand (at the center of the board) provides pressure against the fence, keeping it flush to the fence. The arrows indicate the direction I'm applying pressure.



2 Walk the board slowly into the blade, keeping the edge flush along the length of the fence. When your left hand reaches the edge of the saw, allow it to slide backward along the length of the board, maintaining pressure against the fence. Maintain this support until the back end of the board reaches the edge of the saw table.



3 Grab your push stick and place it on the back edge of the piece between the blade and fence. Apply pressure forward, and slightly toward the fence with the push stick as you continue the cut. Your left hand should only be used to apply minimal guiding pressure on the fall-off piece until the piece is separated, then move your left hand out of the way. Once the keeper board is clear of the blade and guard, turn your attention to the fall-off piece and push it safely forward, again using the push stick.

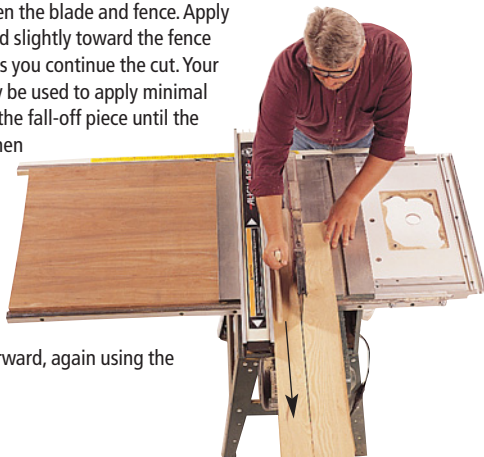

CROSSCUTTING A BOARD

1 When crosscutting a board, the substantially thinner width of the piece (and not enough width to ride adequately against the fence) causes us to use a miter gauge rather than the fence. You may note the gauge in our photos is not standard equipment. We recommend either adding a backing board at least 24" long to your miter gauge, or purchase an aftermarket gauge.

Start by checking to make sure your miter gauge is square to the blade. Then align your cut and support the board against the gauge with one hand on the gauge and the other stretching across the piece to hold it in tightly against the gauge. If your piece is too wide to reach across, it's smart to clamp the piece against the gauge during the cut.

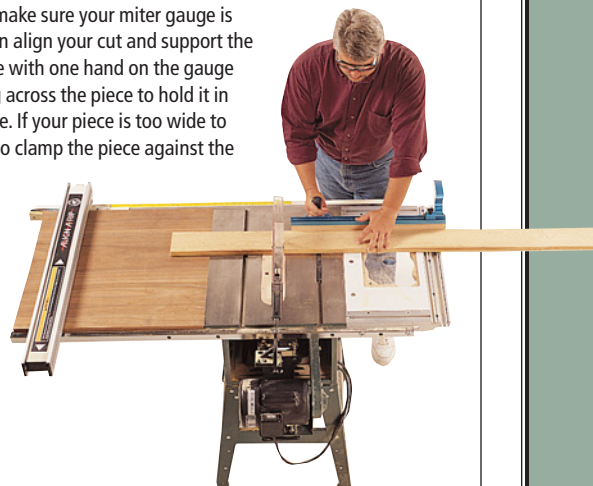

2 Guide the gauge and board into and past the blade.



3 Once the board is cut through, allow the fall-off piece (to the left in the photo) to lie in place. With your left hand, push the board away from the blade, sliding it along the gauge. Then turn the saw off. Once the blade stops spinning, pull the fall-off piece away from the blade.



CROSSCUTTING PLYWOOD

Crosscutting a sheet of plywood on a contractor saw is a task safely accomplished with the use of roller stands. Though plywood is bulky, you don't have to worry as much about the board pinching the blade in the cut because plywood doesn't have a grain direction like solid wood.

1 Here you see one stand positioned to one side of the table saw, and another positioned at the outfeed side. When using the rip fence, do not crosscut a piece less than 18" wide and over 48" long. There is too much chance of the board shifting and becoming pinched. Start the crosscut by standing in the center of the board to support the length. Keep your eye on the fence and keep the board tight against it. Again, arrows indicate where my hands are applying pressure.

2 Maintain the center position as you push the board through the blade. Keep your eye on the fence!

3 Once the board has cleared the blade, let the fall-off piece lay where it is, and carefully push the piece between the fence and blade past the blade and onto the roller stand. Keep the piece flush against the fence until the piece is clear. Then lift the fall-off piece out of the way.



RIPPING PLYWOOD

1 Ripping a 4' x 8' sheet of plywood on a contractor saw is possible, but delicate. Roller stands are a must, and they should be positioned to support the largest piece coming off the saw, or preferably both pieces. To start the cut, you should be positioned near the rear corner of the sheet as in the photo, supporting the back end of the sheet with your right hand, while your left hand provides pressure against the fence and aligns the sheet flush to the fence. With the piece pushed nearly up to the blade, check the fit against the fence again, then slowly walk the sheet into the blade.

2 As you move forward, keep your eye on the fence to keep the sheet flush along the fence. As the balance of the weight of the sheet is transferred to the saw table you can shift your position to the rear of the sheet, supporting from the back, but still maintaining pressure against the fence with your left hand. Continue to push the sheet forward, paying attention to the point when the sheet contacts your roller stand (to make sure it's riding on the stand, not pushing it over), then continue the cut. My roller stand is not shown in the photos.

3 As you reach the end of the cut, allow the outfeed piece (under my left hand) to come to a rest and transfer your attention to the piece between the fence and blade. Push this piece clear of the blade, careful not to extend your reach over the blade. Once clear of the blade and guard, lift the piece up and over the fence and bring it to rest to the side of the fence opposite the blade. Don't try to drag the piece back toward you over the guard. With that piece safe, continue to push the waste piece forward and away from the blade until it clears the blade and guard. **PW**

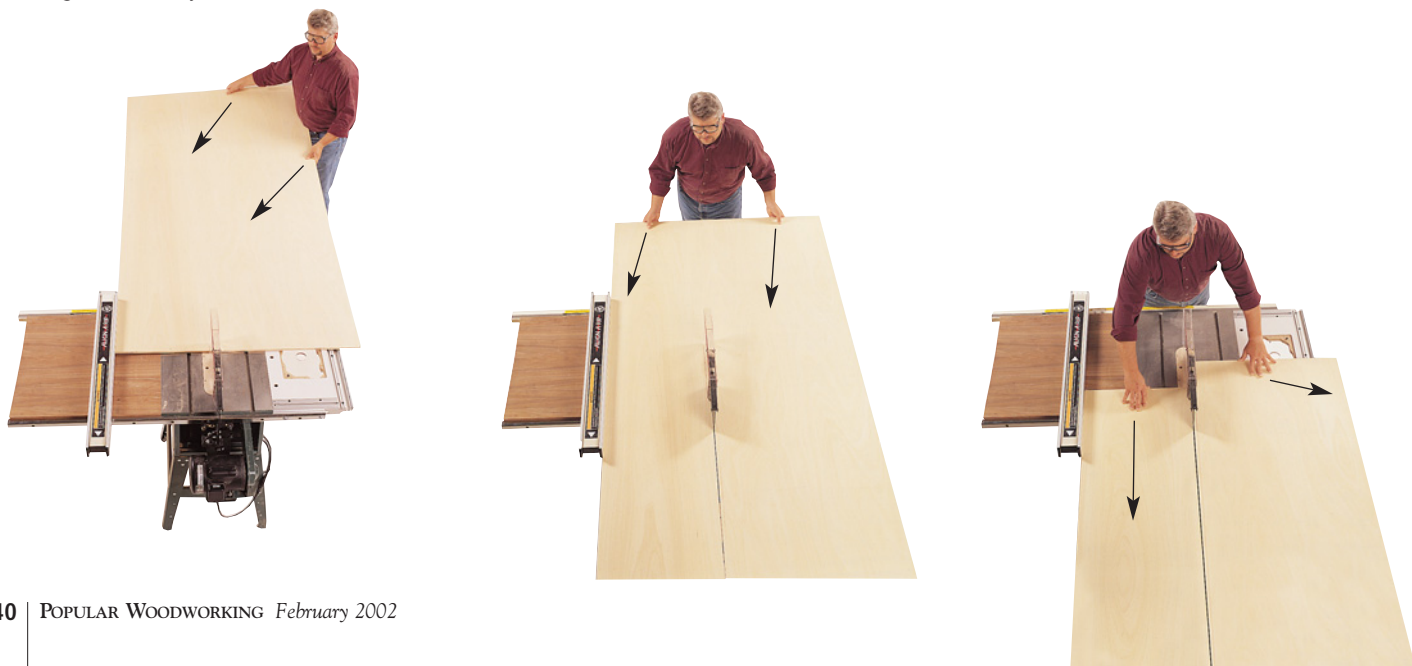

CHOOSING A CONTRACTOR

Table Saw

Today's contractor saws offer performance and quality at a price that makes woodworking possible for all.

Recently a subscriber asked us to simplify our tool reviews and recommend only one tool as the “Editor’s Choice.” While that might seem to make things easier for our tool-buying readers, it isn’t the right thing to do. Our test of premium contractor saws is a prime example of why.

Of the nine saws we tested in our shop, all performed the routine woodworking tasks assigned to them. Certainly some machines were a little easier to use and some performed a bit better. But they are all pretty good saws and a few of them are simply excellent machines.

Another complication is determining the saw that’s the “Best Value.” With some tools, the low-price leader isn’t worth buying no matter what the price. However, with better manufacturing overseas and increased competition there are now lower-priced tools available that can save you hundreds of dollars without sacrificing enough performance or convenience to outweigh the bargain.

Motors and Fences

A table saw needs to do two things well. First, it needs the guts to



Photos by Tim Grondin.

It’s a pretty unusual sight to see a monster power feeder on a contractor saw. But that’s the machine we chose to feed boards through each of the nine saws we tested. The power feeder ensured that all the boards were fed at the same speed and with the same pressure.

perform what would be considered normal operations. That’s not to say it won’t bog down in 8/4 hard maple — most contractor saws will. The saw also must be equipped with a fence system that allows easily repeated, accurate set-ups without a lot of fuss. And it must be easily adjustable so you can set it at 90°

to the table and parallel to the miter slot. Some saws make it difficult to calibrate the fence. All three “Editor’s Choice” saws have very simple and intuitive fence adjustments. Beyond the fence and motor, everything else is gravy. I like gravy, but sometimes a pad of butter is enough.

For the test, we assembled each

saw according to the manufacturers’ instructions (whether good or bad). We set the blades and fences square and parallel. We then checked each machine for noise, vibration, ergonomics and fence accuracy.

Next we tested the motors. To level the playing field, all nine saws were equipped with a new Freud 40-tooth Teflon-coated finishing blade — an excellent carbide blade. All the saws were wired for 110-volt operation. Using a Grizzly power feeder (shown at left), we ran 7/8"-thick poplar boards through each saw at a speed slightly above standard hand feeding. We then observed how much more amperage the motor pulled from the wall and how much the motor’s rpm decreased under that load. All of these statistics are listed on the accompanying chart.

Niceties and Oddities

Aside from the motor and fence, we also noted differences in the other features on these saws. First, the miter gauges are frequently not worth keeping. Of all the gauges, only those on the General and Grizzly were pretty good.

On the subject of blade guards, most of them are a hindrance to woodworking. But there have

by David Thiel

Questions or comments? You can contact David at 513-531-2690 ext.255 or at david.thiel@fwpubs.com.

been improvements. Ridgid's guard is easily slipped on and off its post without tools, making it more likely to be used. Other guards worth mentioning are DeWalt's, which has a smaller splitter (that actually reduces binding rather than promotes it) and the Powermatic guard has independent side shields that do a better job of keeping the blade covered during crosscutting.

And dust collection — usu-

ally a joke on contractor saws — really works well on the Ridgid, Craftsman and DeWalt units.

Winners

In the end, we decided on more than one winner. Three equally priced saws take top honors: the Delta, Jet and Powermatic.

The Jet and Powermatic are nearly identical (Jet owns Powermatic), with the major difference being the Jet is a right-

tilt saw and the Powermatic is a left-tilt. While we think left-tilt machines are safer; this is a personal preference and either of these saws is a good choice.

The Delta saw is different in many ways and outperformed the other saws in the most categories. The Unifence system is equal in accuracy and reliability to the T-style fence offered on the Jet and Powermatic units, and does a lot of extra tricks, too.

When it comes to value, it was a tough call. The Grizzly and Bridgewood were tight competitors for this honor. Both required some extra set-up and patience during assembly. But once that's done, both are good performers for the price, but the Bridgewood pulls ahead with at least one solid-cast iron wing (and the extra legs thrown in), the left-tilt motor and a slightly better quality rip fence. **PW**



BRIDGEWOOD TSC-10CL

The Bridgewood TSC-10CL is the least expensive saw in the test, but it offers good power, a good T-style fence system and a left-tilt mechanism, which we prefer. The rip fence offers aluminum faces on both sides that have T-slots for attaching stops or fixtures. To square the fence to the table, you need to shim a pad underneath the fence. The solid cast wing is nice, though a second wing would have been better. The saw is currently sold with a free leg set (not shown) — and a laminate-covered table board is available for an extra \$70. The blade height and tilt adjustments operated smoothly with positive stops. The saw is shipped without a blade, and if that keeps the price low, we're OK with that. In general most of the features were average. Again, if it keeps the price low, OK. Downside? Assembly took more work than with other saws. It was necessary to shim the fence's infeed bar with washers to raise the fence to a workable height. Also, some masking tape was needed on the fence to square it with the tabletop. But even with these complications and the less-than-pristine fit and finish of the machine, it's a sweet saw at a great price. And so we gave the Bridgewood Best Value honors on the strength of the better quality rip fence, left-tilt capability and the solid cast-iron wing.

www.wilkemach.com/800-235-2100



CRAFTSMAN 22859

The 22859 was one of the nicest saws to assemble. The instructions are excellent and there were many small details that made assembly a joy. The 22859 was nicely packaged, with individually labeled hardware bags. The fence rails slide onto square-head bolts in place on the tables, and the switch location is adjustable. When assembled, the fit and finish of the tool scored very well. Operating vibration was better than average and the handles were comfortable to use and easy to reach. Unfortunately the rest of the testing didn't fare as well. Though the saw offers a micro-adjustable fence (which can be helpful), we needed to shim the mechanism with six washers to align it correctly with its toothed gear. There are no positive stops on the blade beveling mechanism, causing a mushy feeling and the need to rely on the bevel indicator, which no manufacturer does correctly. Though the fence moves smoothly, it cannot be adjusted square to the table without shimming. Adjusting the fence parallel to the blade is very difficult, and the fence's scale is only in 1/16" increments and not easy to read. The motor performed acceptably, but on the whole the saw was ultimately not worth the \$800 price.

www.craftsman.com/800-377-7414



DELTA 36-426

The word "Delta" means "saws" to a good many woodworkers, and the 36-426 supports that image. The saw arrived nicely packaged with all the components well protected by lots of cardboard. The instructions were good, illustrated with photos, and actually tell you how to remove the goopy protective coating on the metal surfaces. The three-piece stamped steel base (as well as the "slide-on" rails) proved for quick, simple assembly ... until we got to the side table/leg assembly. This proved over-complicated, though ultimately the legs add stability. The Unifence is a versatile, precise and reliable system that is a strong competitor to the T-style clones. The fence moved smoothly, the scale is readable, and the ease of adjustability proved superior to all others tested. While not a determining factor in the results, we were pleased with the 50-tooth combination blade included. With the extended table board, the Delta offered a full 5" more working surface than any other saw tested. Also, the Delta is one of two saws tested that offered a two-wrench blade changing feature, improving ease of use even further. Not everything was perfect, though. The height and beveling handles are undersized and feel of lesser quality than those on other saws. The blade guard cannot be raised completely out of way when in use and uses a safety feature to keep it from locking open at all unless the throat plate is in place. In the end, the benefits offered by the Unifence system, overall quality of the assembly, fit and finish, and the quiet and capable motor made us choose the Delta as an Editor's Choice.

www.deltawoodworking.com/800-438-2486



adjust the fence square to the tabletop using a screwdriver here

adjust the fence parallel to the miter slot and blade by turning this nut with your arbor wrench

A Class by Itself

The Delta Unifence (above) offers both parallel and square adjustment to the table without lifting the fence from the saw. Though you may only have to adjust the fence once a year, it's very convenient to have all the adjustments easily accessible. Also note the unique aluminum fence face that can be oriented in either a high or low height arrangement on either side of the fence rail, and can be slid forward or back for improved support. This fence offers great versatility for the user.

Locks the Bevel

Both the Craftsman and Ridgid (shown right) saws employ a blade bevel lock, but not a height adjustment lock. Our initial concerns were that while the bevel lock could prove useful, would the blade creep down during dado operations without a height lock? After testing we found that no creep occurred. Likely the fine thread adjustment requiring 35 revolutions to raise and lower the blade made these saws less susceptible to height creep. Though we appreciate that improvement, we didn't enjoy the extra revolutions necessary to adjust the blade height.



DeWALT DW746

The DeWalt DW746 was one of the easiest saws to assemble (arriving mostly assembled), with most of our assembly time spent being impressed by the design features on the model. This saw is unlike the other machines in this test because it has an internally mounted motor and a blade beveling wheel mounted on the left of the saw. We found the saw's instructions to be less than thorough, but adequate to the setup task. As mentioned before, the dust collection shroud around the blade works extremely well. The fence system is also different; it's a T-style fence that locks both at the front and rear. We found the fence to be smooth operating, accurate, easy to read and generally easy to set up and adjust. The aluminum fence face offers forward and back adjustment similar to the Delta Unifence, which is an asset in a number of situations. The DeWalt is one of two models tested that offer a two-wrench blade change system. The motor performed well, and the vibration is pleasantly low. We rated the DeWalt as having the best height and tilt adjustments with convenient handles that operated smoothly and positively. Even though the wings are of sheet metal construction, the heavy gauge of the metal makes these lighter-weight wings accurate and sturdy. The DeWalt finished very well in our testing, and was only edged out for Editor's Choice recognition due to the higher price. You may be able to argue that the price is justified if the option of adding the sliding table (another \$400) is important to your style of work.

www.dewalt.com/800-433-9258



GENERAL 50-185

The General contractor saw is a fine and capable saw with a decent instruction manual and a fair assembly. Its strong points are its well-placed and manufactured handles, a good quality cast iron miter gauge, and an easy-to-use and read T-style fence system. The saw is also offered in either a right- or left-tilt version, (the only model tested that is), so if the tilt direction is important to you, General can help you either way. Overall the General motor performed capably and the use of the fence system and all adjustments worked smoothly and accurately. If you want to adjust the fence square to the table, you need to shim a pad beneath the fence. There's no real nice way to say this, but the General is a very capable, but average saw. It doesn't excel beyond the other tested models in any significant category, but has features that make it a very workable tool. The pricing is comfortably below the highest price, but is also not low enough to make this saw a true bargain.

www.general.ca/819-472-1161



GRIZZLY G1022Pro

The G1022Pro is new to the Grizzly family for 2002, but it looks familiar. The machine is essentially the G1022FX with the Shop Fox Classic fence added. That's a good thing. Assembly was of average complexity, and not always explained well in the instructions. Once assembled, the Grizzly performed well in a number of categories, not least of which was the performance of its 2hp-rated motor (make sure your shop circuit can handle this motor). Strong features include a Powertwist link belt to reduce vibration, good cast iron miter gauge and a fence system that operated well (though less smoothly than some other T-style clones tested in this review). The scale on the fence was a tie for best readability, and the vibration during operation was very low. The saw arrived in our shop with the blade mounted 1/16" off parallel to the miter slots (a quick fix) and there were sharp or rough spots on the machine to be filed or sanded. The open cast wings are a bit of a compromise, and we'd prefer solid cast wings instead, but priced at \$550 it's an extremely affordable package. When compared to the lower-priced Bridgewood, the Grizzly offers two cast iron wings and a beefier motor for an extra \$50. This saw is a great deal, and was only beat out for Best Value honors by the Bridgewood by a whisker.

www.grizzly.com/800-523-4777



Editor's Choice

JET JWTS-10PF

Our test of the JWTS-10PF started off a little rocky. While the assembly was generally user-friendly, we ended up having to do some extra drilling to align the holes on the fence rails. The bevel pointer was bent out of orientation during shipping, and the instruction manual could have done with some better photography. But after the assembly was complete, the strong points of the saw became obvious. Motor performance proved to be excellent, while offering extremely low vibration. The fence system, the reliable T-square clone design, proved accurate, easy to read and easy to use. With the two solid cast iron wings and a table board the work surface is a very ample 56 $\frac{1}{4}$ " wide. The fit and finish on the tool was very good, with little room for complaint. This saw is extremely close in design to the Powermatic 64A, with the major differences being the right-tilt design and a noisier (though better performing) motor on the Jet. In deciding which tools to award Editor's Choice to, we decided that ultimately it was more important how the tool continued to operate, rather than what it took to set it up the first time and felt it appropriate to recognize the Jet, as well as the Powermatic.

www.jettools.com/800-274-6848



Editor's Choice

POWERMATIC 64A

One of the first affordable contractor saws offered with a T-style fence and a left-tilt design, the 64A has seen some upgrades since Powermatic was purchased by the Jet Group. Though still very similar to the Jet saw in features and design, assembly proved easier on the Powermatic with improved imagery in the instructions as well. The Powermatic has a somewhat less efficient motor than the Jet, but still very respectable and a significant nine decibels quieter motor than the Jet. But for the paint color, the fence systems on the two saws are nearly identical, though the lever on the Powermatic's fence was beefier. We did encounter more vibration from the Powermatic unit, but to counter that the blade guard on the Powermatic is of a superior design for ease of use, and they've added some plastic caps on the fence rail (for appearance) and added leveling feet on the base. Both saws are priced the same, so picking between the two was tough. So we decided to let you decide. If you prefer a left-tilt machine with a quieter motor, the Powermatic is for you. (Mobile base in photo not included.)

www.powermatic.com/800-248-0144



RIDGID TS2424

We found the packaging on this saw to be quite impressive. Packaged to fit in two economically sized boxes, the parts were nested within each other throughout, but all parts were well protected and well labeled to make assembly smooth. Even the motor was boxed, and the box itself offered a handle to help lift the motor conveniently, which is usually like wrestling a greased hog. The TS2424 comes standard with a mobile base that is a little fussy to set up, but a welcome accessory. Interestingly the open cast wings (though not our personal favorite due to finger injuries) were the only wings attached using bolts and nuts, rather than machine bolts threaded into the main table. The fence rail attaches using slip-over T-bolts, making assembly efficient and quick. The fence system also employs a micro-adjust feature like the Craftsman, but the Ridgid's relies on friction against the rail, rather than a toothed gear. To adjust the fence square to the table you'll need to shim underneath pads below the fence. The saw is shipped with a decent dust collection box mounted under the saw and includes a hose hookup and hose. The motor mounting and pulley guard were simple to attach and user-friendly. For all the nice touches and user-friendly features on this saw, it still comes down to using it on a day-to-day basis. While the saw tied for least vibration and quietest of those tested, we found the motor capable, but not stellar and the fence lacking in ease of use and scale readability, leaving the Ridgid model in the middle of the pack.

www.ridgidwoodworking.com/800-474-3443



Small Refinements Are Nice

While it may not seem to be important, the redesign of the pulley guard (left) on the Craftsman and Ridgid saws made mounting the motor and adjusting or replacing the belt simpler. The more traditional metal guard requires two or three hands to mount the motor and more often than not a wing nut ended up in the sawdust during the struggle.

How About a Cabinet Saw?

If you're planning on spending \$850 on a nice contractor saw, you might want to think about a cabinet saw instead. Amazingly, Grizzly Industrial offers the G1023S, a 3 hp, 220-volt cabinet saw for less than \$800. This saw includes the T-style design Shop Fox Classic rip fence. Cabinet saws have more power, less vibration (the trunnions are mounted to the cabinet, not the top), and a more stable working platform. Grizzly also offers a left-tilt version (shown above) for \$895 and a version with a smaller motor than runs on 110 power. We've had the G1023S in our shop for two years and find it an excellent option (if you can get 220 power in your shop) to a contractor saw — at the same price!



	BRIDGEWOOD TSC-10CL	CRAFTSMAN 22859	DELTA 36-426	DEWALT DW746	GENERAL 50-185	GRIZZLY G1022PRO	JET JWTS-10PF	POWERMATIC 64A	RIDGID TS2424
Street price	499	800	850	900	730	550	850	850	600

GENERAL									
Ease of height/tilt adjustments	4	3	3	4	5	3	3	3	3
Overall vibration	5	2	3	4	3	4	5	3	5
Initial trunnion alignment	5	5	5	5	4	3	5	5	5
Max. blade height	3 ¹ / ₈ "	3 ³ / ₈ "	3 ¹ / ₈ "	3 ¹ / ₈ "	3"	3 ¹ / ₈ "	3 ¹ / ₈ "	3 ¹ / ₄ "	3 ³ / ₈ "
Blade guard quality	3	3	3	3	3	3	3	4	4
Miter gauge quality	3	2	3	3	4	4	3	3	3
Total weight	242 lbs	265 lbs	295 lbs	254 lbs	300 lbs	290 lbs	300 lbs	310 lbs	244 lbs
Handle comfort	3	4	3	4	5	3	3	3	5
Turns to max. blade height	12	36	12	22	12	14	13	12	35
Turns to max. blade bevel	30	30	29	22	31	29	29	30	29
Adjustable feet?	No	Yes	No	No	Yes	No	No	Yes	Yes
Fit and finish	3	4	4	5	3	3	4	4	4
Ease of assembly	3	5	4	5	3	3	4	4	4
Type of blade supplied	None	40T-ATB	50T-ATB	30T-ATB	None	None	28T-ATB	40T-ATB	40T-ATB

MOTOR									
Listed amp. rating	16amp	13amp	12.8amp	15amp	15amp	26amp	18amp	18amp	13amp
Amp draw with no load	10.2	4.7	3.9	4.7	6.3	18	10.4	10.2	5.6
Amp draw under load	20	13.3	13.4	16.5	19	25.8	19	20	14.3
Percentage amp increase	96%	183%	244%	251%	202%	43%	83%	96%	155%
RPM with no load	3,586	3,585	3,588	3,583	3,583	3,580	3,575	3,585	3,589
RPM under load	3,442	3,484	3,507	3,496	3,434	3,478	3,471	3,433	3,447
Percentage RPM decrease	4%	2.8%	2.3%	2.4%	4.2%	2.8%	2.9%	4.2%	4%
Noise level (dB)*	84	81	78	79	86	88	85	76	76

TABLE									
Material	CI	CI	CI	CI	CI	CI	CI	CI	CI
#/Type of wings	2/SCI	1/SCI	1/SCI	2/SM	2/SCI	2/OCI	2/SCI	2/SCI	2/OCI
Table size (inches)	27x30 ¹ / ₄	27x53 ¹ / ₂	27x62	27x40 ³ / ₄	27x40 ¹ / ₄	27 ¹ / ₈ x40 ⁵ / ₈	27x56 ¹ / ₄	27x57	27x44
Table height	36 ¹ / ₂ "	36 ¹ / ₂ "	34 ¹ / ₄ "	34 ¹ / ₄ "	34 ³ / ₄ "	37"	34 ¹ / ₂ "	35"	36"
Rip capacity/left of blade	12"	24"	12"	16"	12"	12"	12"	12"	24"
Rip capacity/right of blade	30"	30"	30"	30"	30"	25"	30"	30"	24"
Blade tilt left/right	Left	Left	Right	Left	Left/Right	Right	Right	Left	Right
Table flatness	5	5	5	5	4	5	4	5	5
Throat width	3 ¹ / ₂ "	3 ³ / ₄ "	3 ³ / ₄ "	3 ³ / ₄ "	3 ¹ / ₂ "	3 ³ / ₄ "	3 ¹ / ₂ "	3 ¹ / ₂ "	3 ³ / ₄ "

FENCE									
Design	T-Square	Rail F&B	T-Square	Rail F&B	T-Square	T-Square	T-Square	T-Square	Rail F&B
Scale accuracy	¹ / ₆ ths	¹ / ₆ ths	¹ / ₃₂ nds	¹ / ₃₂ nds	¹ / ₃₂ nds	¹ / ₃₂ nds	¹ / ₃₂ nds	¹ / ₃₂ nds	¹ / ₃₂ nds
Scale readability	3	3	4	4	4	5	4	4	3
Ease of aligning fence to miter slot	3	3	5	4	3	3	4	4	3
Ease of use	3	4	5	4	4	4	4	4	3
Ease of adjusting square to table	3	1	5	3	3	3	3	3	3
	BRIDGEWOOD TSC-10CL	CRAFTSMAN 22859	DELTA 36-426	DEWALT DW746	GENERAL 50-185	GRIZZLY G1022PRO	JET JWTS-10PF	POWERMATIC 64A	RIDGID TS2424

KEY

Ratings are based on a 1-5 scale with "1" being "poor" and "5" being "excellent." Trunnion alignment is how the machine was shipped, either in alignment, or out of parallel to the miter slot. *Noise level was tested with the blade set a 1" height above the table and the level was taken with a decibel meter held at head height. Table flatness was measured using a straight-edge and feeler gauges - any gap less than .005" was considered acceptable. Fence alignment refers to the ease of fence adjustment parallel to the miter slot. Vibration was measured with the saw on a level surface using a dial indicator. CI=cast iron; SM=sheet metal; SCI=solid cast iron; OCI=open cast iron.

T A B L E S A W

Outfeed Tables

Don't let the simplicity of these tables fool you. When used together they make many operations easier and serve many other tasks that aren't immediately obvious.

You can find all sorts of devices for sale to support your stock as you feed it over your table saw. Some sport rolling pin-style rollers, some have a series of roller balls. Some attach directly to your saw, others offer micro-adjustment to level it to the precise plane of your saw table.

My humble outfeed table offering has no such features. In fact, they are about as “plain Jane” as you can get. Remove them from the shop and no one would take them for anything other than what they are — a pair of trestle tables.

So what's the big deal? Well, if you operate in a small shop space, say a garage or basement, these tables will serve so many useful purposes you'll wonder how you ever did without them.

I've been using a pair of tables just like these in my basement shop for the past five years. They surround my table saw and can be easily repositioned for ripping long stock, crosscutting a full sheet of plywood and supporting long crosscuts using my table saw's sled (and they give me a place to hang the sled when it's not in use). But wait, there's more.

These tables also serve as stock support for both sides of my compound miter saw. I use them as smaller assembly tables, for stack-

ing stock while I'm planing or jointing it. Sometimes I finish projects on them. And because they are also the same height as my regular assembly table, I can put larger objects on both.

I arrived at the trestle-style design because it's not only stout and material-efficient, but it keeps the base enough “inboard” so that you're not bumping table legs with your feet. It also keeps the weight down and makes them easy to slide on your shop floor.

Getting Set for Building

Before you start construction, measure the distance from the floor to the top of your table saw. There can be as much as an inch or two variance in heights. The plans given here are for a saw that is just over 34" high. You should make your tables' height $\frac{1}{8}$ " less than your saw's height and reduce the height by as much as another $\frac{1}{8}$ " if your shop floor isn't very

level around the saw. What can make these tables useless is if they are even a bit higher than the saw table. In my book, being slightly under doesn't matter.

And if you wonder why I didn't use levelers, I'll tell you. It's just not worth the hassle of adjusting them every time you move a table, let alone two of them. And you'd have to do this every time, owing to variations in the floor or the fact that most screw-adjustable levelers will wind or unwind just by dragging the table across a floor. When maintaining a plane in critical work, perhaps with a miter saw, shims or wedges are quick and easy.

Construction Details

I built these tables using both mortise-and-tenon joints and dowel joints. You could use only dowels if your shop isn't set up with mortising equipment. And in fact, my original tables were

constructed entirely using biscuit joints and screws and are no worse for the heavy service they have seen. If you don't use mortises, remember to deduct the length of the tenons from the parts list.

I used stout white oak for the bases because I had some $\frac{3}{4}$ " stock on hand. But since I finished it out to $\frac{1}{2}$ " thickness, you might want to consider using ordinary 2 x 4s. Just don't use twisted ones.

Follow the diagrams and cutting list to prepare your stock in the correct sizes, making any allowance for a difference in table saw height in the leg parts.

Next take the feet, top rails and legs for Table 1 and lay out the mortise locations as shown in the diagram. All tenons are $\frac{1}{2}$ " thick by $1\frac{1}{4}$ " wide by $1\frac{1}{4}$ " long. Make the mortises the same dimensions except in depth. Make them $\frac{1}{16}$ " deeper so the tenons don't bottom out before they seat home.

Layout Trick: Work From the Center Out

When I do layout work I often find it handy to use a couple tricks. Take the top rails and feet of Table 2, for example. It's really important that the mortises and dowel joints line up perfectly for the legs. To pull this off, I group all the parts together so their ends align perfectly. You can

by Steve Shanesy

Comments or questions? Contact Steve at 513-531-2690 ext. 238 or steve.shanesy@fwpubs.com



even throw a square on the group to make sure they aren't creeping out of alignment. Clamp them so they can't move.

Next, locate and mark from each end the center of the leg locations ($7\frac{1}{8}$ ") on one of the parts. Since the feet get mortises that are $1\frac{1}{4}$ " wide, measure out $\frac{5}{8}$ " from each side of the center lines.

Now take a square you know to be true and transfer these lines to the other parts. For the top rail, use the same lines to align your doweling jig. Later, you can transfer these lines onto the leg parts for identical jig alignment. Grouping parts and measuring from the center out cuts down on simple errors of missed or incon-

sistent measuring on common parts. The beauty of this method is that even if you are off slightly, everything remains off consistently. After laying out the mortises, cut them all.

Cut the Tenons

Next cut the tenons, fitting them to the mortises. I use the table

saw for this job, setting up the saw using scraps of fall-off from the actual parts so their dimensions are consistent with the materials I'm working with.

I cut the cheeks using the table saw's fence, standing the parts on end to run them over the blade. Use a back-up block to support the tall stock when making these

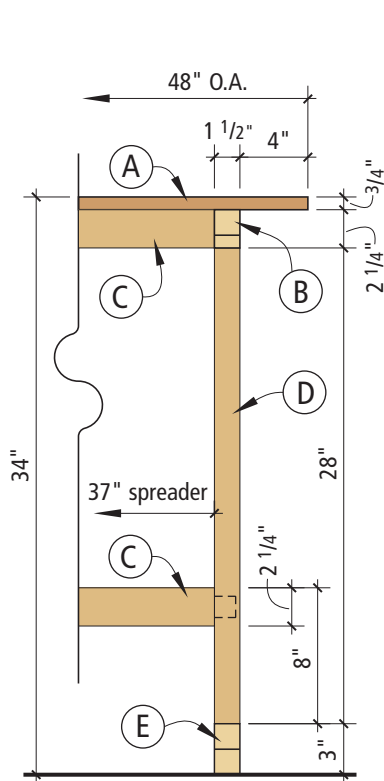

Table 1

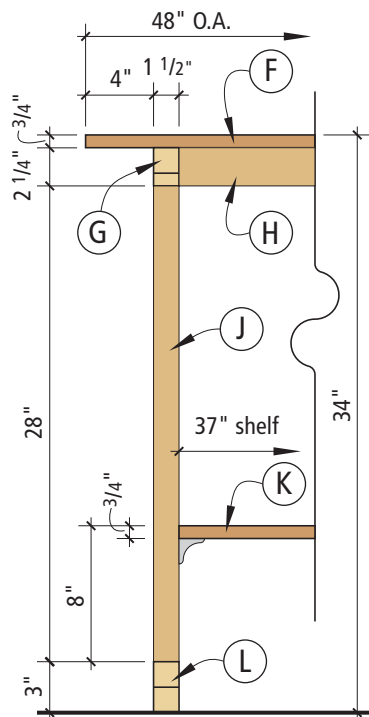
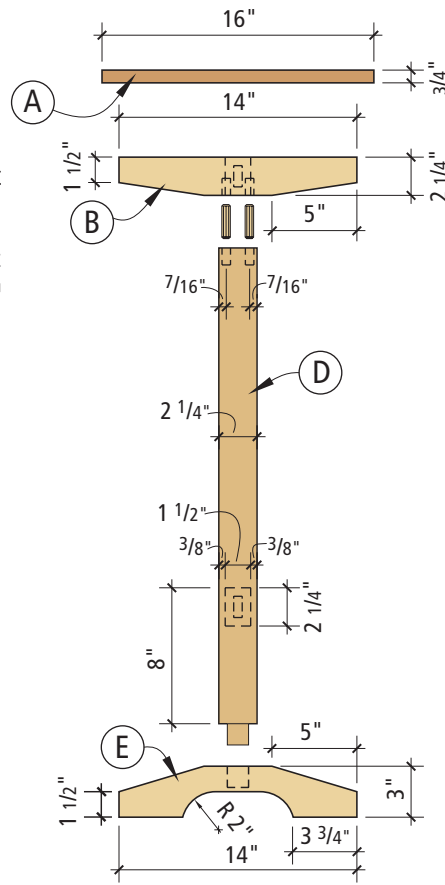
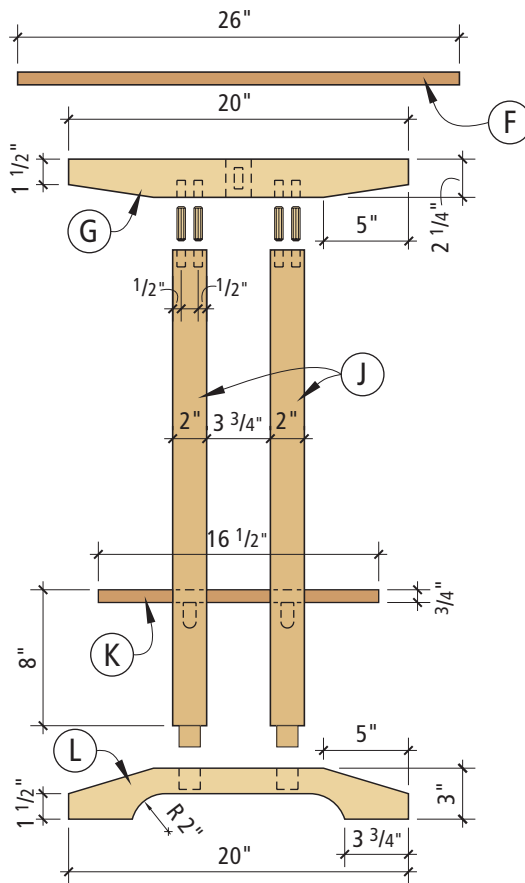

Table 2



It may take a little "persuading" to seat the tenons in their mortises, but if properly fit should only require tapping in place.

cuts. To finish the tenons I band saw off most of the waste from the cheek cut. I then set the table saw fence to establish the final length of the tenon. With the stock on its side and guided by a slot miter gauge, trim the remainder of the cheek waste. Then turn the part to the other side and make the shoulder cut.

In this project, since there weren't a lot of tenons, I just made a series of passes over the rest of the shoulder to cut away the waste. Otherwise, I would have set up a dado stack to do the work more quickly.

Before you make the final shapes on the top rails and feet, lay out and drill for the pair of

When gluing up, assemble the ends first and let them dry before completing the table base assembly by gluing the stretchers to the ends.





Joining the top stretcher to the top rail and the leg to the top rail on Table 1 requires the dowel placement to straddle the mortise.



The top rails are joined to the legs using two 1/2" dowels for each leg while the bottom uses a mortise and tenon. Other joinery options include dowels only, mortises only or biscuits.



dowels at the top of the leg-to-rail joint on Table 1. Position them so they straddle the mortise in the rail as shown in the diagram.

Next make the angle cuts on the rails and feet, and the cutout on the bottom of the feet. Follow the layout in the diagram, then band saw out the waste. Smooth the rough band-sawn edges.

Before gluing up, make a dry-run assembly to make sure everything is right before you get to that panic glue-up stage. After making any adjustments, start gluing up, but don't try to do everything at once. First glue up and

clamp the leg/rail end sections. Once those are dry, glue the stretchers to the ends. Although this takes a bit longer, it allows you to make sure your glue ups are square and flat. A twist in a table base is a real pain.

Once the base is completely assembled, you can call it done or rout a 3/8" radius profile on all the edges except where the feet meet the floor and the top rail and stretcher attaches to the top. I did this on my tables and think it makes them appear more "finished."

The tops and shelf are straightforward. Cut plywood to the sizes

given, then glue and tack on 3/4" x 1/2"-wide solid edging. Tack below the center point so you can rout a 1/4" radius profile on the top edges. This detail isn't optional; the rounded edge helps prevent stock from catching on the edge when the tables are in use.

Before attaching the shelf on the larger table, sand the base and tops to your satisfaction. I didn't bother with a finish on my tables. These are for the shop, after all.

To attach the shelf, use corner braces at each of the four legs. If you change the height of the shelf for any reason, just make sure it won't interfere with your table saw's motor hanging out the

back of your contractor saw.

And by the way, if you are already set up and happy with an outfeed system for your shop, remember that you can always change the height of these tables and use the design and joinery for any number of other trestle-style tables. **PW**

OUTFEED TABLES

NO.	ITEM	DIMENSIONS (INCHES)			MATERIAL
		T	W	L	
TABLE 1					
□ 1	Top (A)*	3/4	15	47	birch plywood
□ 2	Top rails (B)	1 1/2	2 1/4	14	white oak
□ 2	Top-Bot stret (C)	1 1/2	2 1/4	39 1/2	white oak
□ 2	Legs (D)	1 1/2	2 1/4	29 1/4	white oak
□ 2	Feet (E)	1 1/2	3	14	white oak
□ 2	Solid edging	3/4	1/2	48	any hardwood
□ 2	Solid edging	3/4	1/2	15	any hardwood
TABLE 2					
□ 1	Top (F)*	3/4	25	47	birch plywood
□ 2	Top rails (G)	1 1/2	2 1/4	20	white oak
□ 1	Top stret (H)	1 1/2	2 1/4	39 1/2	white oak
□ 4	Legs (J)	1 1/2	2	29 1/4	white oak
□ 1	Shelf (K)*	3/4	15 1/2	36	birch plywood
□ 2	Solid edging top	3/4	1/2	48	any hardwood
□ 2	Solid edging top	3/4	1/2	25	any hardwood
□ 2	Solid edging shelf	3/4	1/2	37	any hardwood
□ 2	Solid edging shelf	3/4	1/2	15 1/2	any hardwood

*Dimension given does not include 1/2"-thick solid edging to be added.

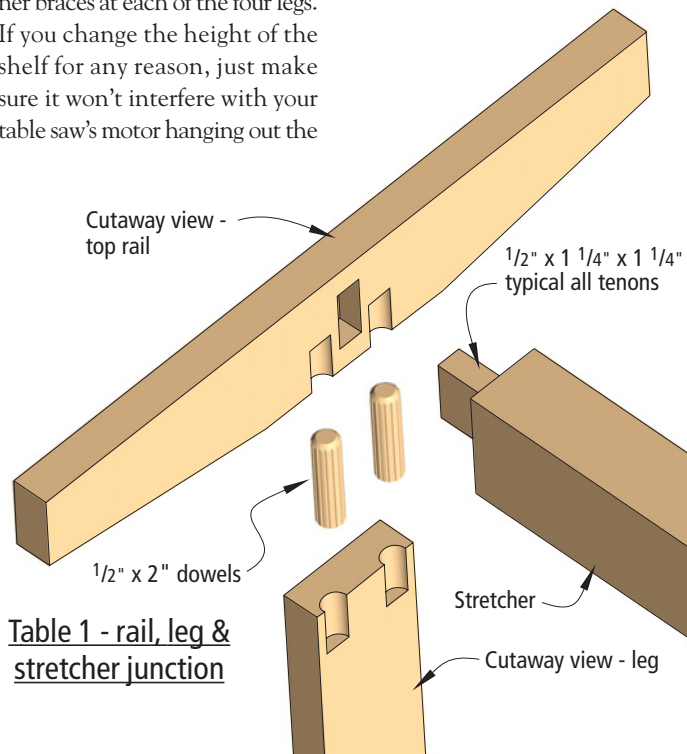

ULTRAFAST Frame & Pane

Build traditional doors
using modern tools.
When you've got it down, try your hand
at this simple cherry stepback.

Without a doubt, mortise-and-tenon joints make the strongest frame-and-panel doors. But this traditional joint strikes fear into the hearts of beginning woodworkers because it requires either precision with a hand saw and chisel or a deep wallet to buy some serious machinery. After 17 years of building doors, I've found a method that is fast enough for a professional cabinetshop but uses tools you'd find in a home workshop.

Essentially, you cut your tenons with a dado stack in your table saw. You cut your mortises with a hollow chisel mortiser, mortising attachment for your drill press or Forstner bit. And you make your raised panels using a router table, table saw or even a shaper.

Now before you start thinking that this sounds really expensive, let's take a minute to do the math. You probably already have an 8" dado stack. If not buy one for \$85. There's lots

of other ways it will be useful in your shop. If you don't have a hollow chisel mortiser, it would be nice to get one of these, too. A decent benchtop model will cost \$250, or you can buy an attachment for your drill press for \$75. Mortising equipment will change your woodworking. Suddenly it's child's play to make everything as stout as a mule. If you don't want a hollow chisel mortiser, you can cut these mortises by chain-drilling overlapping holes using a Forstner bit in your drill press. Finally, to make the raised panel you can use a raised-panel bit in your router table or shaper, or you can raise the panel on your table saw using a rip blade.

I design my inset doors (as I did for this project) so they're exactly the same dimension as the door opening. Then I trim them down on my jointer to get a perfect $\frac{1}{16}$ " gap all around. Begin building your doors by milling out your stock to the proper thickness. Doors are made up of stiles (the vertical pieces), rails (the horizontal pieces) and the panel. Make your rails and stiles $\frac{3}{4}$ " thick and your panel $\frac{5}{8}$ " thick. Cut your rails and stiles to size but leave the panel oversized until assembly.

Cutting Tenons

I like to cut the tenons first because it is faster.

by Troy Sexton

Troy Sexton designs and builds custom furniture in Sunbury, Ohio, for his company, Sexton Classic American Furniture. Troy is a contributing editor for Popular Woodworking.

Illustration by Mary Jane Favorite.

1



Photo by Al Parrish.

SUPPLIES

Rockler • 800-279-4441

Non-mortising hinges
#31300 • \$5.79 a pair.

2 wooden knobs

Here's why: Your mortising bit (or Forstner) makes a slot of a consistent width (unlike when you make a mortise using a chisel and mallet). That means you can depend on every mortise to be exactly as wide as your first one. So if you cut your tenons on the rails first (with the help of a piece of scrap with a mortise in it), you can simply lay the tenon on the stile where it needs to go and use the tenon like a ruler to mark the starting

and ending point of the mortise.

This procedure saves you a step because you don't have to get out your combination square to figure out where your shoulders will go on the stiles.

For most cabinet doors I like to cut tenons that are 1" long and have 1/2" shoulders. The rule of thumb is to make your tenons one-half the thickness of your stock. So for 3/4" stock your tenons should be 3/8" thick.

I cut my tenons on the table saw using a dado stack. Here's how. First get a piece of scrap. Go to your mortiser or drill press and make a long mortise in that scrap using a 3/8" bit. You use this piece of scrap to check the thickness of your tenons. Make the mortise in the scrap about 1 1/16" deep. Install your dado stack in your saw. The number of chippers isn't critical. Make the stack 5/8" - or 3/4" - wide. Now raise the dado stack so it's 3/16" high.

Set your table saw's fence so

that the distance from the left-most tooth to the fence is 1". Get out your miter gauge and make sure it's set perfectly square. Put your rail flat down on the table of the saw. Define each side of the tenon in two or three passes as shown in the photos.

Hold the work firmly and keep your fingers away from the blade. Flip the rail over and repeat these cuts on the other side. If you have trouble with tearout, try making the first cut on the tenon with the tenon against the fence. It

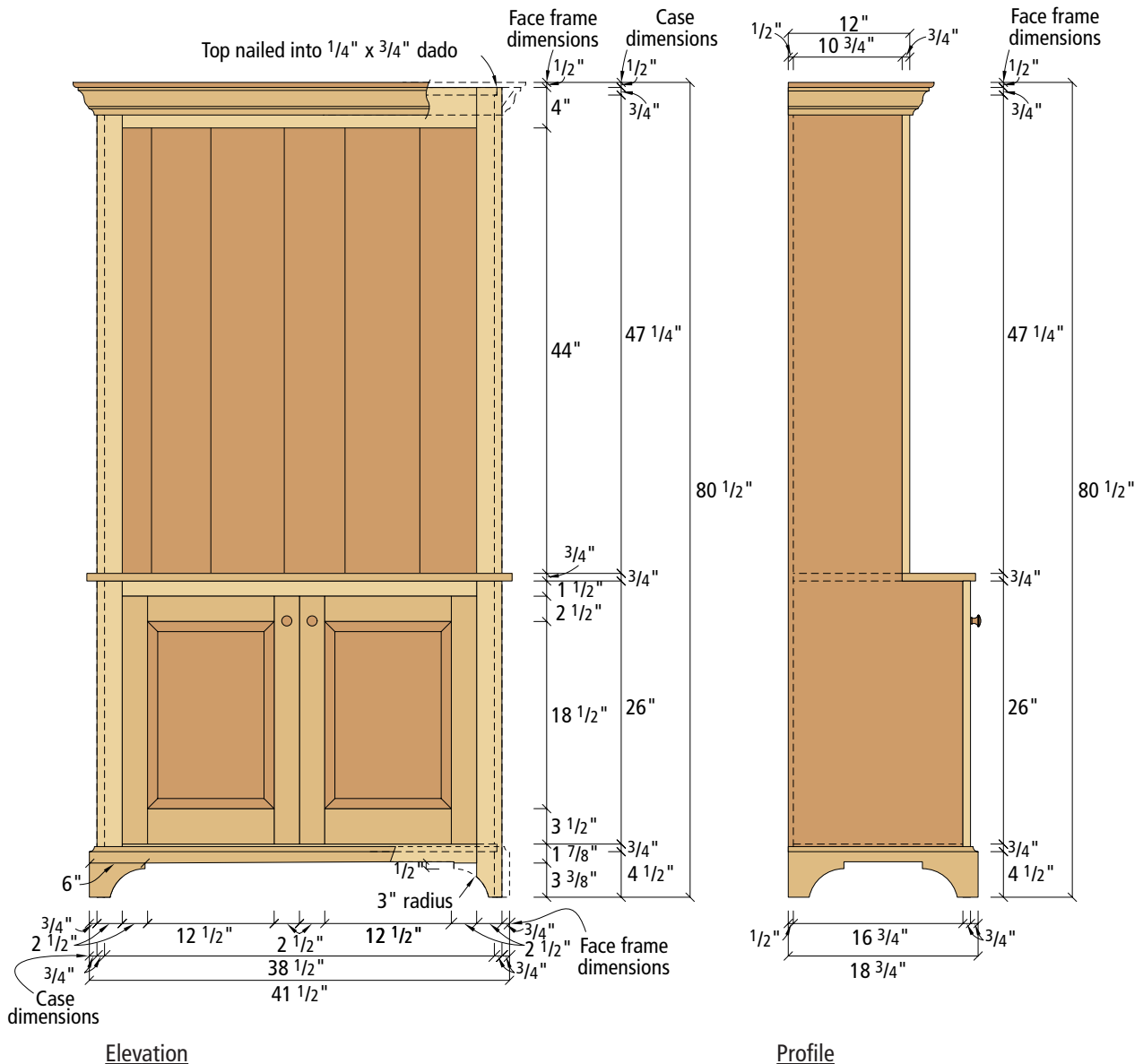

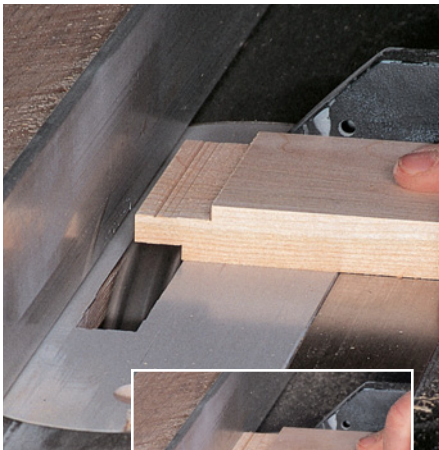

Here I'm cutting the tenons on the rails. Use the fence to limit the length of the tenon.

it's time to cut the shoulders and the haunch. What's a haunch? It's an uncut part of the tenon that fills the $\frac{3}{8}$ " x $\frac{3}{8}$ " groove you'll soon make for the panel in both the rails and stiles.

To cut the haunch you could readjust the fence and perhaps take a couple chippers out of your stack. What a pain. Instead, I take piece of $\frac{3}{8}$ "-thick scrap and attach it to my fence. Then I run the rails on edge on one side (see photo). Instant and perfect haunch. Now remove the $\frac{3}{8}$ "-



To cut the haunch, keep the same setup on your table saw and merely add a $\frac{3}{8}$ "-thick spacer to your fence. Run the rail on edge and your haunch is cut.

thick scrap from your fence and cut the shoulders on the other edge. Lay out the locations of all the mortises using the tenons you just cut.

Machining Mortises

Mortising is the most straightforward part. You want your mortises to be centered on your stock and about $1\frac{1}{16}$ " deep. The little extra depth ensures your tenons won't bottom out in your mortises and makes a place for the excess glue to go.

When you use a mortising machine, here are a couple of good rules that aren't in most manu-

als. First, don't cut the holes so they overlap. You want to make a hole, skip a small space and then make your next hole. Then come back and clean out the waste between the holes.

This prevents your mortising chisel from deflecting or even breaking during a plunge cut.

Second rule: after you make the mortise, go back and clean out the bottom. I do this by repeatedly plunging the mortising bit to the bottom of the mortise in short strokes while moving the stile in small increments. This will get rid of most of the junk at the bottom of a mortise and prevent you from having to clean up

your work with a chisel.

The Panel

To fit the panels, the first step is to cut the $\frac{3}{8}$ " x $\frac{3}{8}$ " groove on the inside edges of the rails and stiles to hold the panel. I use a dado stack in my table saw to accomplish this quick chore. Adjust the height of the blade until your haunch fits into the groove snugly.

Now dry-assemble the stiles and rails and measure the opening for the panel. Add $\frac{1}{2}$ " to the height and width and that's the finished size of your panel. Cut your panel to finished size on your table saw. If you want a flat panel door without a raised detail, sim-

CHERRY STEPBACK

NO.	ITEM	DIMENSIONS (INCHES)			MATERIAL
		T	W	L	
2	Sides	$\frac{3}{4}$	$17\frac{1}{4}$	80	Cherry
1	Top	$\frac{3}{4}$	$11\frac{1}{4}$	39	Cherry
1	Bottom	$\frac{3}{4}$	$17\frac{1}{4}$	39	Cherry
1	Countertop	$\frac{3}{4}$	$18\frac{1}{4}$	$41\frac{1}{2}$	Cherry
3	Shelves*	$\frac{3}{4}$	$10\frac{3}{4}$	$38\frac{1}{2}$	Cherry
1	Top FF rail	$\frac{3}{4}$	4	37	Cherry
1	Mid FF rail	$\frac{3}{4}$	$1\frac{1}{2}$	37	Cherry
1	Lower FF rail	$\frac{3}{4}$	$1\frac{7}{8}$	37	Cherry
2	Top stiles	$\frac{3}{4}$	$2\frac{1}{2}$	48	Cherry
2	Lower stiles	$\frac{3}{4}$	$2\frac{1}{2}$	$31\frac{1}{4}$	Cherry
2	Door top rails	$\frac{3}{4}$	$2\frac{1}{2}$	$14\frac{1}{2}$	Cherry
2	Door bot rails	$\frac{3}{4}$	$3\frac{1}{2}$	$14\frac{1}{2}$	Cherry
4	Door stiles	$\frac{3}{4}$	$2\frac{1}{2}$	$24\frac{1}{2}$	Cherry
2	Door panels	$\frac{5}{8}$	13	19	Cherry
	Bot moulding	$\frac{3}{4}$	$5\frac{1}{4}$	84	Cherry
	Top cap	$\frac{1}{2}$	3	90	Cherry
	Back boards	$\frac{1}{2}$	$39\frac{1}{2}$	76	Cherry

* shelves have a dropped edge on the front.

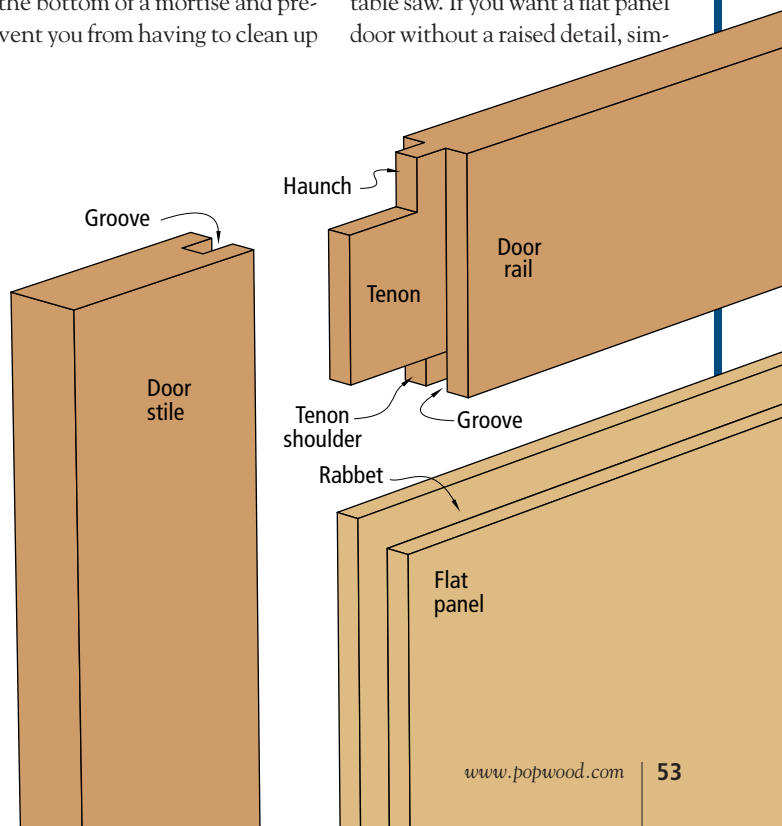



I like to cut most of the bevel on the raised panel on my table saw (left). Then I use a vertical raised panel bit in my 1½ hp shaper to cut the profile in one pass (above).

ply cut a ¼" x ¼" rabbet on the backside of the panel (as shown in the drawing on the previous page) and move on to assembly.

If, however, you want that beveled edge on your panel to add a shadow line, you need to do a little more fiddling. The end result is to create a bevel on the panel that is about 1½" wide, at about a 12° angle and that fits snugly into the groove you cut in the rails and stiles.

If you've got a shaper or a router table with a big variable-speed router, you can buy a panel-raising bit for just this purpose. When you cut the bevel on the edge, don't do it all in one pass. Instead, take several passes to get you where you want to be. Or, better yet, cut most of the meat off using your table saw, then make the bevel cut in one pass on your shaper or router table. When making the cut on the router or shaper, cut the profile on the top and bottom of the panel first, which is where you're most likely to have the ends blow out. Then follow up by cutting the profile on the sides. This should clean up any tear-out from the first two cuts.

If you want to raise the panel using your rip blade in your table saw, set the blade's height for 1½" and tilt the blade about 12° away

from the fence (you might have to move your table saw's fence to the other side of the blade to accomplish this). Now move the fence up to the blade and make several test cuts on a piece of scrap until you've nibbled away just enough so the bevel fits in the groove.

You want the bevel to snugly into that groove so there's a ⅛" gap between the edge of the panel and the bottom of the groove. This will give your panel room to expand and contract.

Dry-fit your doors to make

sure everything goes together. Before you glue up the door, sand the bevel. I use a random-orbit sander with great care. You can hand-sand the bevel, but it will take considerably more time. Finish-sand the back-sides of the panels all the way to your final grit.

Assembly

The trick here is to glue only the mortise-and-tenon joints, not the panel. Put glue in the mortises and clamp the door. Don't overtighten

the clamps; you can easily twist the door. When the glue is dry, sand the rest of the door.

Because the panel will expand and contract with the seasons, I like to add a bit of insurance to the door to make sure the panel won't slide around too much when it shrinks. The insurance is two brad nails. I nail the panel to the rails through the groove at two locations on the back of the door. One nail goes at the center of the top rail and one nail in the center of the bottom rail. This will still allow the panel to expand and contract, but it will keep it centered. **PW**



To save time and effort, I glue up the panel for the countertop from two boards so it will fit perfectly into the dados in the sides.

BUILDING THE STEPBACK: A PLAN OF PROCEDURE

1. Cut all your stock to size; glue up any panels you might need. When gluing up panels for the sides, use one board that is 11¼" wide and 80" long, and one board that is 6" wide and 31¼" long. Glued together on edge, these form the corner where the countertop goes. Use the same procedure for the countertop.
2. Build your face frames for the upper and lower cabinet using mortise-and-tenon joinery.
3. Build your doors using mortise-and-tenon joinery.
4. Cut ¼"-deep dados in the sides to hold the bottom, top and countertop. Cut a ½" x ½" rabbet on the back of the sides for the back pieces. Drill holes for the adjustable shelf pins.
5. Nail and glue the top and bottom pieces between the sides. Nail the face frames to the case. Slide the countertop in place and glue and nail.
6. Cut solid wood pieces for the shiplapped back. Finish sand all pieces.
7. Hang the doors. Nail commercially available crown moulding in place. Add a ½" cap on top. Stain or dye all the parts then add three coats of a clear finish.
8. Nail the shiplapped back in place.

KREG JIG PAGEMAKER FILE

Circle #136 on Reader Service Reply Card

Dust Collector

"If you have a small shop this is the perfect dust collector, I love it!" Lloyd Diamantis, Albany NY.

- Flexible design options
- Perfect for the small shop
- Compact 2' W x 2' L x 7'2" H footprint
- 1.5 hp delivers 700 CFM @ 8" static pressure
- Internal pleated spun bond polyester filter cartridge
- High efficiency filtration 99% on 0.2-2.0 micron material

Engineered ductwork design
& parts list provided



Editors' Choice
2000 & 2001!



Dust collection systems & components 1.5 hp & larger

Free Brochure!

1-800-732-4065 www.oneida-air.com

Oneida Air Systems 1001 W. Fayette St. Syracuse, NY 13204



Proudly made in the USA

Circle #137 on Reader Service Reply Card

THE WORLD'S BEST ROUTER JOINERY JIGS BY LEIGH



The Rout Stuff.

D4 Dovetail Features:

- Infinite spacing of pins and tails
- Through dovetails up to 1 1/4" thick
- Half-blind dovetails up to 1 1/2" thick
- Sliding dovetails up to 1 1/2" thick
- All three can be cut in boards up to 24" wide
- Imperial or metric measurement scales

Comes standard with:

- Two cutters for 1/2" to 3/4" through dovetails
- 168-page fully illustrated User Guide
- D4 Dovetail Jig Instructional Video
- Cam-Action Speed-Clamps
- Adjustable side stop for angled dovetails



Router not included

Leigh Joinery Jigs have it all. Hobbyist or professional, the Leigh D4 Dovetail Jig will ensure you create your best work. Versatility, precision and superb value make the Leigh Dovetail Jig better than the rest. Rout through and half-blind dovetails, with variable spacing of pins and tails, on one jig. Create decorative Isoloc joints, finger joints, and multiple mortise & tenons effortlessly with Leigh attachments and our exceptional user guides! Get the right stuff for the job. Call toll free now!

Call For Your FREE Leigh Catalog Today! 1-800-663-8932

LEIGH

Joining Tradition With Today

Leigh Industries Ltd., PO Box 357
Port Coquitlam, BC Canada V3C 4K6
Toll free 1-800-663-8932 Tel. 604 464-2700
Fax 604 464-7404 Web www.leighjigs.com

Tank Heaven

End bathroom clutter
and elude the annoying plop of destiny.

At least once a year I knock something off the bathroom counter, right into the toilet. It's usually a highly non-disposable item, like my favorite hairbrush. There follows the humbling act of fishing the item out of the bowl. Then the challenge of cleaning it off. The dishwasher is tempting, unless you live with nosy people who'd want to know why your hairbrush is in the cutlery rack on Sani-cycle.

I don't blame myself for knocking stuff into the toilet, because it's society's fault. In the old days, a single bar of soap served as shampoo, shaving foam, skin care regimen and deodorant. Washing was a once-a-week proposition. People smelled a bit but they spent most of the day behind a horse who didn't seem to mind. Folks got cleaned up on Saturday night to prepare for the next morning, when being crammed into a church pew was the social event of the week.

In contrast, today's society is a teeming 24/7 press of bodies, with people crushed together in buses, offices, restaurants and movie theaters. We don't do much of anything alone and we can't afford to smell like it.

And here's my huge, salient point: there just isn't adequate surface area in modern bath-

rooms to contain all the tools families require for personal grooming. Many families have an arsenal of products perched around the sink, the edges of the tub, and atop the toilet tank.

Society gave us this clutter. But God gave us elbows. So on a bad day, one of those personal grooming products is going for a swim.

My answer to society and my elbows was to build a pine tanktop shelf-unit. It hangs in the unused space above my toilet tank, holding every pomade, soap and lotion I've accumulated in years of smelling nice.

This unit is a great beginner's project with some easy options for making it look professionally hand-crafted. To build it you'll need only a few basic tools, my favorite being the jigsaw.

Tool's Errand

If you're new to woodworking and you're only planning to get one saw,

make it a jigsaw. They generate about as much noise as a sewing machine, so they're soothing to use, plus they perform almost every kind of cut, from straight to swoopy. I recently got the cordless purse model so I'm ready to jig anytime, anywhere.

And while we're talking about tools; for sheer tingle factor, whenever you have a birthday or anniversary coming up, ask for clamps. You just can't have too many clamps. You'll need at least one pair of clamps for this project with a minimum span of 20". If you don't have clamps, you're going to have to engage a helper. Clamps are more useful than most helpers, unless the helper brings beer.

And finally, to make your shelves look especially perky, consider buying a plug-cutter bit. This is a cool little device that fits in your drill just like a regular bit. It cuts tiny cylindrical wood plugs that camouflage the screw heads, so the finished project looks tidy and sleek.

Cut it Out

Lumber is personality-related, so know yourself. Clear pine is slick and cooperative, but the knotty stuff has more character. Also, if you have a low irritation threshold, avoid boards that are twist-



by Mag Ruffman

Mag Ruffman's how-to TV series "Anything I Can Do" airs in Canada, the U.K., Europe and Asia. For more project instructions, visit www.anythingicando.com.





When you're riding your jigsaw around the curves, guide the blade smoothly so you don't create bumps and dings that you'll have to sand out later. Many jigsaws have a dial that allows you to adjust the stroke of the blade to be either gentle or aggressive, depending on the wood you're manipulating and the mood you're in.



A Veritas cornering tool makes short work of softening the edges of pine. It acts as a miniature plane, leaving a smooth radius in its path. If the blade chips or binds, then you're working against the grain. Try pulling from the opposite end of the board. Grain lines always get wonky around knots, so you may have to change direction several times, but it's still faster than sanding.

ed, cupped (the ends of the board are crescent-shaped), split, or sporting "pitch pockets," dark spots that ooze sap and defile your work surface, tools and mood.

Take your time in the lumber aisle and use the "eyeballing" technique: Pull a board off the rack and put one end of it on the floor. Then, holding the other end at eye level, scrutinize your subject for twists, warps and wows. Flip it authoritatively, glaring down the length of each surface of the board in turn. If the board is clean and straight, put it on your cart. If it isn't, set it aside and move on to inspecting the

next board.

Once you've got the boards cut to length, decide on a profile for the side pieces. If you're feeling jaunty and self-assured, mark the shape directly onto the board and cut it out with your jigsaw. If you've gotten into trouble this way in the past, draw the shape on cardboard first and cut it out to be sure it looks OK. Some people like to construct entire mockups in cardboard just to test the dimensions. I prefer to wing it and live with my mistakes, which explains my van, but that's another story.

Next, draw the wavy shapes for the 18"-long top and bottom rails. To achieve symmetry in your design, take a 9"-wide piece of paper or cardboard and draw a curvy line on it. Cut the design

out and trace it onto one half of the 18"-long board. Then flip the cardboard over and trace the design onto the other half of the board. Repeat the process for the bottom border, varying the design a bit so it isn't exactly the same shape as the top.

If you have an earnest reverence for our outhouse heritage, you may have the urge to add a crescent-moon somewhere on your unit. Draw the shape where you want it and drill a generous hole in the middle of the moon. Insert your jigsaw blade into that hole, and proceed to cut out the moon. You should definitely use a scrolling blade for this purpose. A scrolling blade is more delicate than a regular jigsaw blade, and can handle tight corners that

would make a standard blade buck.

Once you've cut out all your pieces, "round over" the sharp edges with sandpaper so they're soft and aged-looking. If you find sanding unfulfilling, either lower your expectations or use a cornering tool to ease all the straight edges. Cornering is a hugely satisfying activity, producing lovely curly shavings that can be used later for homemade potpourri.

Shellac Luster

After all that sanding you're going to want some instant gratification. It's tempting to screw the whole unit together right here, right now. But do yourself a giant favor and put the stain, paint or clear-coat on the individual pieces before you go any further. It is SO MUCH EASIER than having to cover all the multiple surfaces of the shelf-unit after it's assembled. Besides that, glue squeeze-out will glom on to bare wood during the assembly process, but if your boards already sport a coat of finish, the glue can be easily wiped off.

My favorite finish is shellac. It's made from the excretions of "lac" bugs that live in trees in India and Indonesia, and if that's not a great conversation starter I don't know what is. This bug residue is scraped off the trees, and then cleaned, filtered and mixed with denatured alcohol to make one of most interesting and least noxious finishes I know of.

There are two ways to buy shellac: pre-mixed or dry form. The pre-mixed stuff has a limited shelf life, so you usually end up having to throw a lot of it out. I prefer to buy dry shellac flakes and mix them with high-quality shellac thinner. "Super Blonde" shellac from Lee Valley Tools is brilliantly clear, plus it's de-waxed, which means it doesn't water-stain.

Even if you don't work with shellac as your final finish, at least

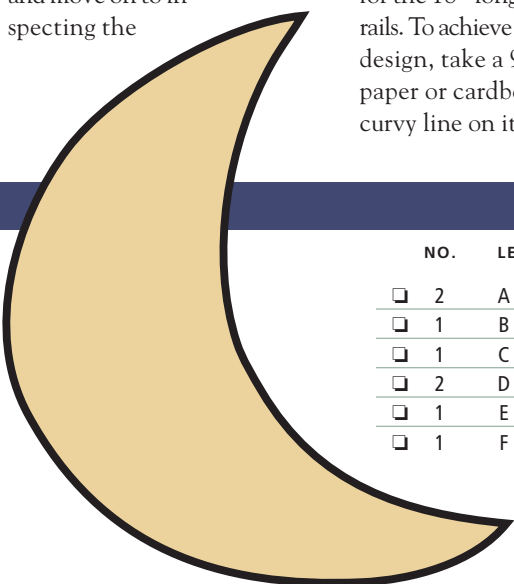

TANK TOP

NO.	LET.	ITEM	DIMENSIONS (INCHES)			MAT.
			T	W	L	
2	A	Sides	3/4	6 1/2	32	Pine
1	B	Top rail	3/4	9 1/2	18	Pine
1	C	Top shelf	3/4	5 1/2	18	Pine
2	D	Mid & bot shelves	3/4	5 1/4	18	Pine
1	E	Bottom rail	3/4	7	18	Pine
1	F	Towel bar	5/8 dia.		18	Dowel

Other materials: Carpenter's glue, 1 1/2" #8 wood screws, shellac, paint, stain or urethane. Cornering tools and plug cutters are available from Lee Valley Tools, 800-871-8158 or www.leevalley.com.

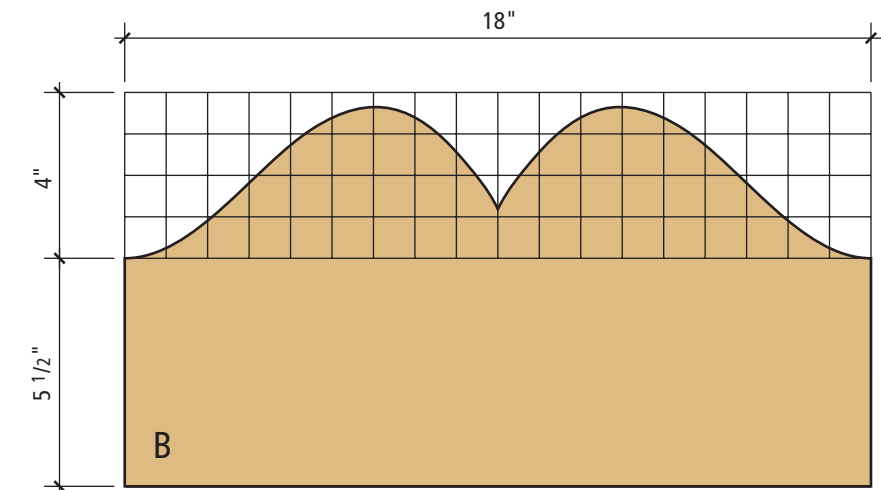
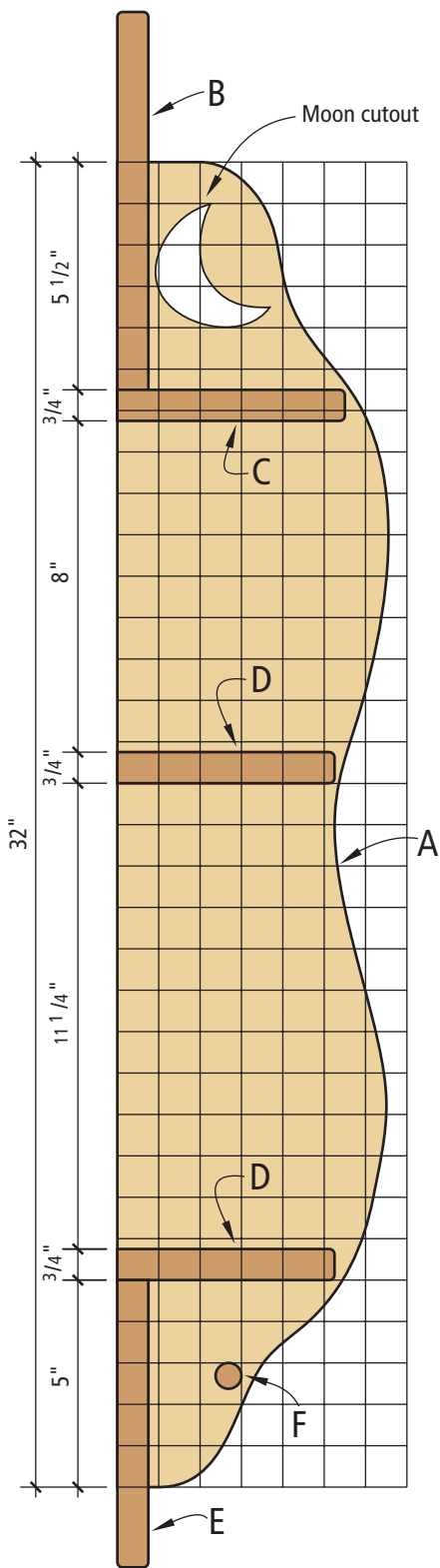

Top rail



Top shelf



Middle & bottom shelves



Dowel towel bar

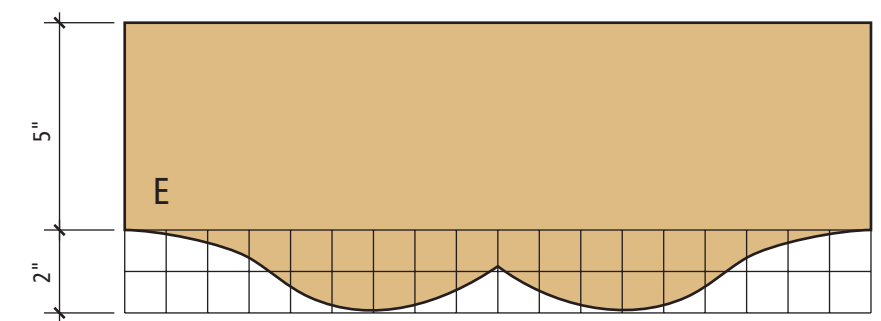

Bottom rail



Shellac has to be applied with a patient, steady hand in smooth, long strokes that don't overlap. Because it's alcohol-based, it dries extremely fast, so there's little downtime. If you're mixing your own shellac, use a good solvent procured from a reliable woodworking supply place.

brush a couple of quick dabs of shellac on any knots. This will seal the knots and prevent sap from oozing up under your chosen finish. In fact, shellac is a great primer coat for pretty much any finish except stain, so don't resist using this fine gift from the bug world.

Fit to be Tried

Now you're ready to dry fit the whole unit. Lay it all out with the sides, shelves and borders in place. This is your opportunity to identify the tallest spray cans in your battery of personal care products. Space the shelves accordingly, so everything fits nicely on the unit when you're done. Clamp everything together lightly, and then square the shelves using a speed-square. Now reef on those clamps so they're nice and tight. Use a pencil to mark a light line on the side pieces under each of the shelves for reference later when you're doing the final assembly under the duress of knowing that the glue is starting to set up.

While all the clamps are in place, pre-drill pilot holes for your screws so you don't split the shelves when you drive the screws. Then, right on top of the pre-drilled

Plug-cutters come in different sizes and varieties. I used a 1/2" tapered bit to cut my plugs. The resulting plugs are slightly narrower at one end, which makes them easier to push into the hole later. One safety tip: To prevent the plug-cutter bit from bucking and skating on the wood, set the teeth of the bit in the wood by leaning heavily on your drill before you begin. Then keep some weight on the drill as you start the motor.

screw-holes, drill larger holes to a depth of 3/8" to make a cavity for the plugs that will hide the screw heads. To avoid drilling the plug holes too deep, it's a good idea to wrap a piece of masking tape around your drill bit 3/8" from the end so you know when to stop.

Now for the wet fit. Take all the pieces apart and apply a modest bead of glue along the edges of the shelves and borders, plus a dab on each end of the towel bar. Reassemble and clamp everything together, and drive those screws. Use a damp rag to wipe away any oozing glue around the joints.

Just Say 'Yes' to Plugs

Once your screws are in place, fire up the plug-cutter and cut the plugs in a scrap piece of pine.

Once you've cut about 30

plugs, use a knife or screwdriver to pop each plug out of its little hole. They'll pop easier if you lever the knife perpendicular to the grain.

TIP: As an alternative to cutting your own plugs, you can buy pre-cut hardwood plugs at the hardware store, but hardwood looks funny when used with a soft wood like pine; the color of the wood doesn't match, plus hardwood isn't as absorbent as pine so the plugs take finish differently and refuse to blend in.

Before inserting each plug into its pre-drilled hole, place a drop of glue on the bottom of each plug and smear it around a bit.

When you have your unit plugged, wait 20 minutes for the glue to set up. Then use a flush-cut saw to cut each plug flush with the surface of the cabinet. If you don't have a flush-cut saw, you can take the plugs down fairly quickly using a sander loaded with 80-grit sandpaper.

Once the plugs are cut and

sanded, touch up the plugs and sides of your shelf-unit with shellac or whatever finish you're using.

Mount 'Em

Now it's time to mount your unit on the wall. My favorite mounting technique is to screw two 2"-long strips of metal plumber's tape (which has prepunched holes) on the back of the shelf-unit, and then lift the unit onto waiting nails anchored in studs above the toilet. Finding the studs is a matter of importance, because you don't want your unit crashing down on you while you're otherwise occupied with a good magazine.

Also, it's vital to leave enough room between the toilet tank lid and the shelf-unit. If the toilet floods, you need maneuvering room to whip the lid off, plunge your hand into the dank tank and slap the flapper back down. You'll remember this ritual from the first time you knocked something into the toilet, and tried to quietly flush it away. **PW**



When drilling the countersinks for the plugs, keep your drill as perpendicular to the surface as possible to prevent the plugs from going in at an angle. I went through a troubled phase of having a fish-eye level stuck on the heel of my drill, but it was just distracting.



What's the secret to building perfect panel doors?



Freud panel bits...now available with backcutters

STEPS TO BUILDING A PERFECT PANEL DOOR:

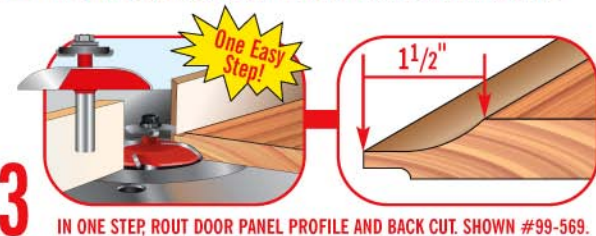
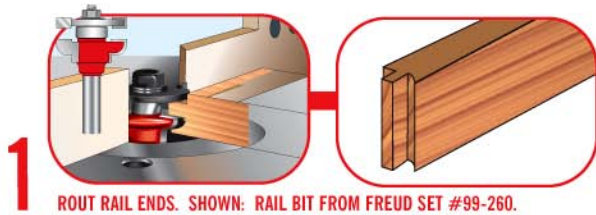

In the past, the only way to make architecturally correct panel doors required the use of two bits. Or, with other raised panel backcutter bits, you had to settle for a smaller profile.

Finally, in one easy step, you can produce panels from $\frac{3}{4}$ " wood with a $1\frac{1}{2}$ " reveal that are flush with the door frame for an architecturally correct appearance. Freud introduces 2+2 Raised Panel Bits With Backcutters.

Available in both bevel and cove profiles, these $\frac{1}{2}$ " shank bits pair a backcutter with Freud's revolutionary 2+2 raised panel bit design. This patented design has four cutting wings that produce an extraordinary smooth finish.

The included 54-562 radius backcutter gives a double-sided appearance and can be replaced with the optional 54-560 square backcutter for a more contemporary look. Shims are included to allow adjustment of tongue thickness from $\frac{7}{32}$ " to $\frac{1}{4}$ " for maximum versatility and compatibility.

Whether you're a hobbyist or a production shop, Freud makes it easy for you to create the perfect cabinet.

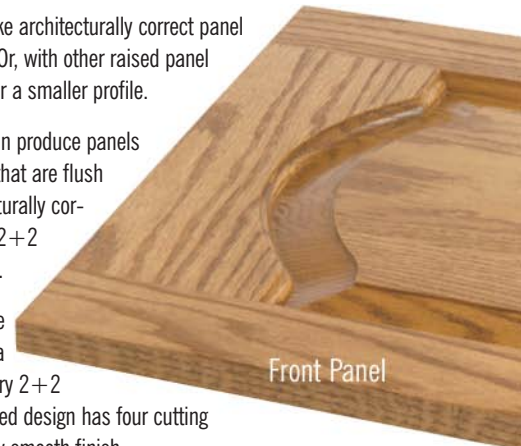

freud[®]

The Psychology of Woodworking

ISO 9002
CERTIFICATE REGISTRATION # 12 100 0100

FOR MORE INFORMATION CALL 1-800-472-7307. IN CANADA, CALL 1-800-263-7016.

U.S. Patent No. 5,899,252
Other patents pending

Red router bits are a registered trademark of Freud TMM, Inc.

Inlay Door

WITH A ROUTER

THE SECOND OF TWO PARTS

In our last issue we gave you plans for the case of this spice box, now we show you how to make the amazing inlay door using your router and band saw.

I'd never tried anything like inlay when I came across the image of a great-looking 18th century spice box. The image struck me and I stopped to consider the skill required to make the piece. When I started thinking harder I realized that the inlay was almost entirely designed with geometric shapes. While I'm no artist, I can handle math and geometry. The more I thought about it, the more I realized it was within my grasp.

In the December 2001 issue (#125) we published the first installment that shows how to build the basic cabinet and a frame-and-panel door for the piece. This time I'm going to show you how to tackle inlay with some jigs, some patience and tools you likely already have in your shop.

Which Comes First: The Inlay or the Recesses?

I debated whether it made more sense to cut the $\frac{1}{8}$ "-deep recesses in the door first and then fit the inlay in place, or to start by making the inlay. In practicing on a piece of inlay I realized that even though I was working toward achieving a specific width, it wasn't easy to end up at the size I'd planned. So I decided to make all the inlay parts first, then cut the recesses to match.

The pictures on this and the following pages provide most of the instruction for this project, but there are some general observations that will prove useful. One of the steps toward a good-looking piece of inlay is to have the different wood types butt against each other with a nearly invisible gap. Because of this, fitting individual pieces by careful hand sanding is critical. That's where the patience comes in.

A light touch proves beneficial when gluing the banding together. If too much glue is applied and left in place, your inlay will show dark glue lines when finished. Take it easy with the glue. It's only holding an $\frac{1}{8}$ " piece of wood in place, and it doesn't take much.

by Glen Huey

Glen Huey builds custom furniture in his shop in Middletown, Ohio, for Malcolm Huey & Sons and is a contributing editor for Popular Woodworking.



1 The first inlay to make is the outer frame. Start by gluing up eight $\frac{35}{64}$ " wide x $\frac{3}{4}$ "-thick strips, angling the glue-up to anticipate the 45° cuts which will follow. When the glue dries, cut a 45° miter on one end, then set your table saw to cut $\frac{5}{16}$ "-wide strips. Be careful and use a push stick.

To form the chevron banding, glue the previously cut strips together, alternating the color pattern. At the same time, glue the $\frac{1}{16}$ " outer striping in place to the outer edges. This will bring the finished pattern to the final $\frac{3}{4}$ " width. I ripped the striping off a $\frac{3}{4}$ "-thick, 4"-wide block on the table saw, allowing the $\frac{1}{16}$ " piece to be the fall-off of the cut for safety. Some sanding on the mating faces (and using only the amount of glue necessary) will keep the glue line as small as possible.

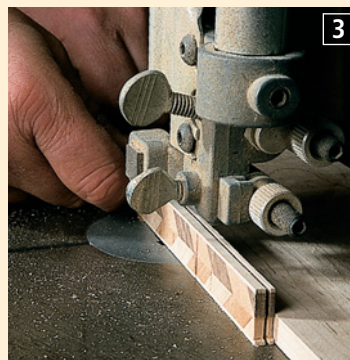

3 After the glue-up is dry, head to the band saw and set up a fence to make a resaw cut, slightly thicker than $\frac{1}{8}$ ". I started with both outside faces of the inlay sanded flat and cut the two outside surfaces from the block. I then resanded the faces of the piece that was left, then made two more cuts. Each piece should yield four lengths of banding. The smooth face on each length is the side that I glued down to the panel.

The inlay pieces are made using cherry, tiger maple and walnut. Straight-grain pieces are easier to work with, especially with the vining patterns, but the tiger maple pattern can also be very attractive in some areas. And in the chevron pattern, I used quarter-sawn grain (or side grain on a flat sawn board) to make the inlay more dramatic. Just choose your wood carefully. And make a few extra pieces, just in case.

The door itself is a $3/4$ " x $12\frac{1}{2}$ " x $13\frac{3}{4}$ " walnut panel. Start with an oversized piece because you'll be nailing guides to the edges.

Wood moves with changes in humidity. After finishing this door, it would be a crime to have



To form the inner circular inlay, I started with alternating walnut, maple and cherry $3/4$ "-thick wedges cut at 22.5° angles on both sides. Glue up enough wedges to make a little over $1/3$ of a circle. To make the glue-up easy, I first put wax paper on a piece of plywood, then arranged and glued the pattern. I then nailed the two outer wedges (at the inner point) to the plywood to keep the pattern from shifting. I then used a band clamp to pull the shape together. Only one section is necessary to complete the pattern.

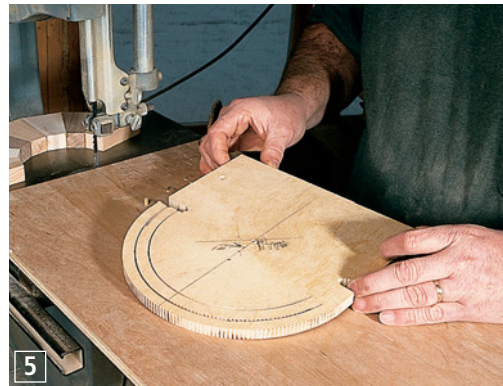

After the wedge blank is dry, use the pattern at the end of this article to make a circle-cutting jig for your band saw. The jig is for a one-time use and will be cut with the blank. The jig is for a one-time use and will be cut with the blank. Pre-drill a center hole in the jig. In the plywood support board attached to the band saw, mark three points ($4\frac{1}{16}$ ", $4\frac{1}{16}$ " and $3\frac{9}{16}$ ") in a line from the edge of the blade. Start with a nail in the farthest hole as a pivot for the template. The wedge pattern blank can be attached to the jig using the same nail locations used during the glue-up. Make the first cut, then relocate the nail in the lower board and continue.



Using the circle jig, I first cut the outer arc on the blank, trimming the square ends of the wedge to a smooth arc. I then moved the jig to the second center hole in the platform and cut the first strip from the blank.

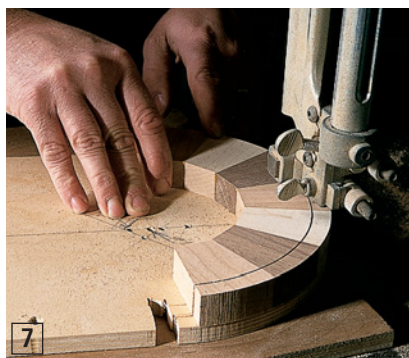

With the first band cut, the center nail is again moved to the closest nail hole in the platform and the inner band is separated from the blank.



Glue the two strips together, again alternating the color pattern. The seam should be fairly close, but a little sanding may improve the joint as thin as possible. Squeeze clamps will provide adequate pressure for the glue-up.



Next, cut $1/16$ " striping for the chevron banding, and add it to the inner and outer surfaces of the arc, finishing out at 1" wide. I used the fall-off from the circle cuts on the band saw as clamping cauls for this step.



Then it's back to the band saw for resawing to complete the four sections. Just as with the chevron banding, sand flats on the outside surfaces, resaw from each side to $1/8$ ", then sand new flats on the remaining piece and resaw again.

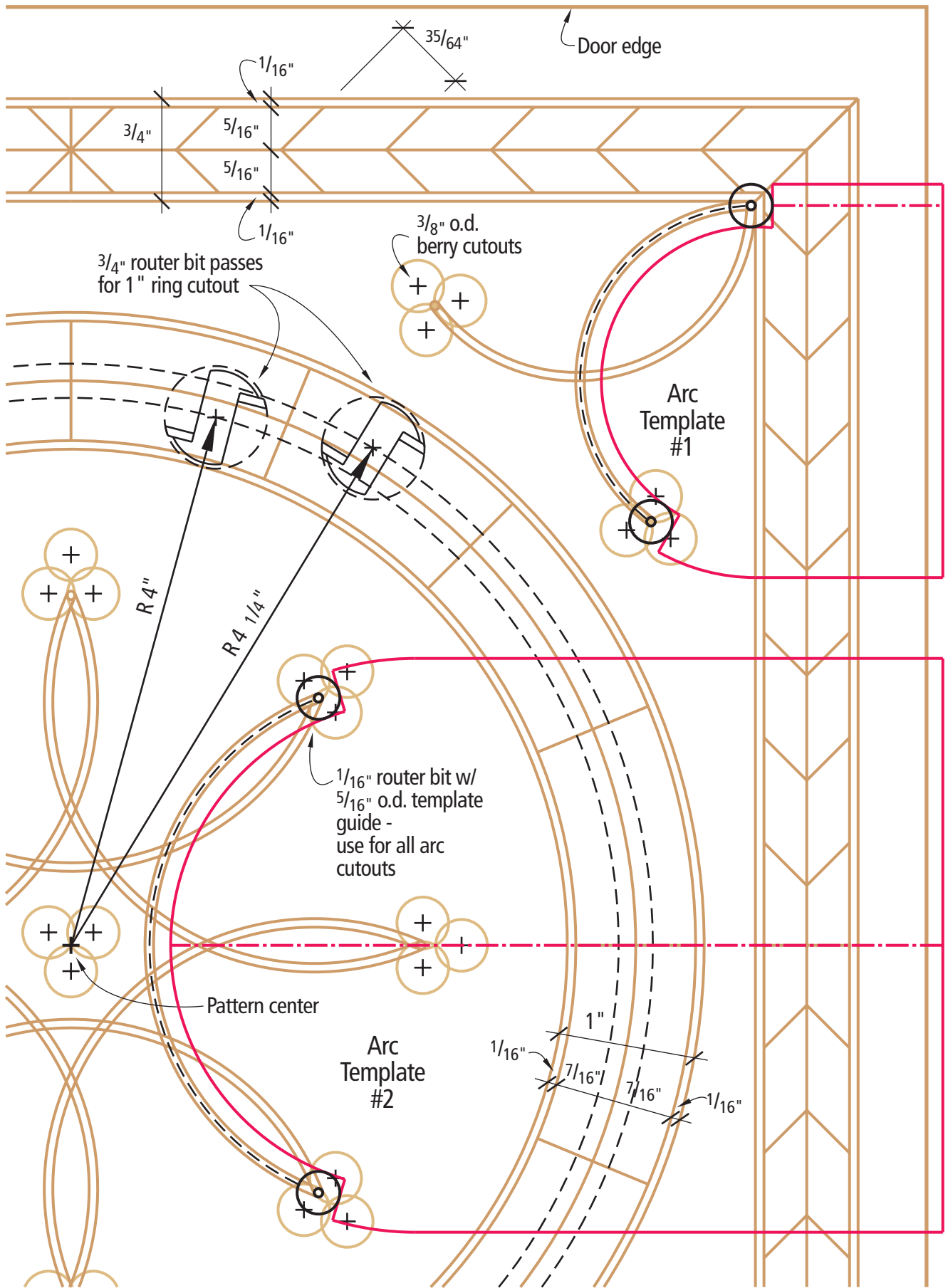

Full-scale plan of door and templates (shown in red).

it warp or twist and mess up the design. Because of this I decided to cut the panel into 2" widths and reglue it together. Of course, you could also make your own solid walnut plywood from three 1/4"-thick panels, but because of all the inlay you don't really notice the grain pattern on the panel itself, so I was comfortable with just ripping and regluing.

I'm happy to say I was able to figure out how to use my beloved power tools for almost every step of this project. Sure, there's a certain amount of hand sanding, and I did have to use a corner chisel, but most of the work was done with the table saw, band saw and routers. I will recommend that you take a few minutes to tune up your band saw before the project. You'll be resawing 1/8"-thick small pieces on that machine and you want that puppy cutting straight, square and smooth.

Finally, I didn't take any pictures of the final sanding process. Once you get all the inlay pieces in place in the door it looks like a little topographical map with bumps and ridges all over the place. When you get ready to sand, take it easy. If you start in with too aggressive a grit you will leave sanding marks in some of the delicate, cross-grain inlay pieces and you could pull something loose. Start with a fine grit sandpaper. I used a random-orbit sander to level the door, but be patient.

If you didn't build the spice cabinet from the last issue (or perhaps didn't even purchase the last issue), you can buy issue #125 (December 2001) from our website at www.popularwoodworking.com. It's a great project with either door, but don't be afraid of the inlay. Heck, I did it! **PW**



With the inlays made, lay out the pattern on the door front. The first step is to cut the circle pattern. I used a shop-made circle-cutting jig (though you can also purchase one), making the 1"-wide recess 1/8" deep in two overlapping passes using a 3/4" straight bit. Start with the outside dimension, then adjust the jig inward to the inner diameter.



For the next step I chose to make a simple 2x4 frame and used a bit with a top-mounted bearing to create the outer border recess. This ensures that the corners will meet accurately. I used a 3/4"-wide straight bit to make the cut with a single pass. After the cut, use a chisel to square out the corners.



To make the banding for the corner arcs, set your table saw to once again slice 1/16" strips from a larger piece. Then carefully slice the strip to a little over 1/8" thick. A straight edge and utility knife will serve well here. Then add a little glue and press them into the recess. Make some extra strips in case some snap. I used tiger maple, which is pretty brittle. Holly would have been easier to work with.



For the "berry" designs, I used a 3/8" plug cutter to make a number of 1/8"-thick dots. Carefully glue these in place. The berries in the center of the pattern are created in the same way.



To make the mating arc inlays in the corners I used a template guide and trim router with a $\frac{1}{16}$ " wide bit. I made the template from a $\frac{1}{2}$ " piece of scrap plywood. The inlay runs out from the outer banding. Use the diagram on a previous page to make your own template so that your cut will start right at the corner. The notches at the ends of the arc will help you start and stop your cuts.



The center mating arcs are made using the same bit and template guide, but a new plywood jig. Note that I used center lines struck on the door front to orient my template jig.



With all the recesses cut, it's time to start putting the inlay in place. I started with the outer chevron banding. Above, I'm marking the center of each run to reverse the direction of the chevrons. This actually makes the pattern easier to glue in.



Finally (though I'm working across the pattern in the photo above) glue the center ring inlay in place. The trick here is getting the four quarter-circle pieces to the correct lengths to mate exactly with almost no visible joint.

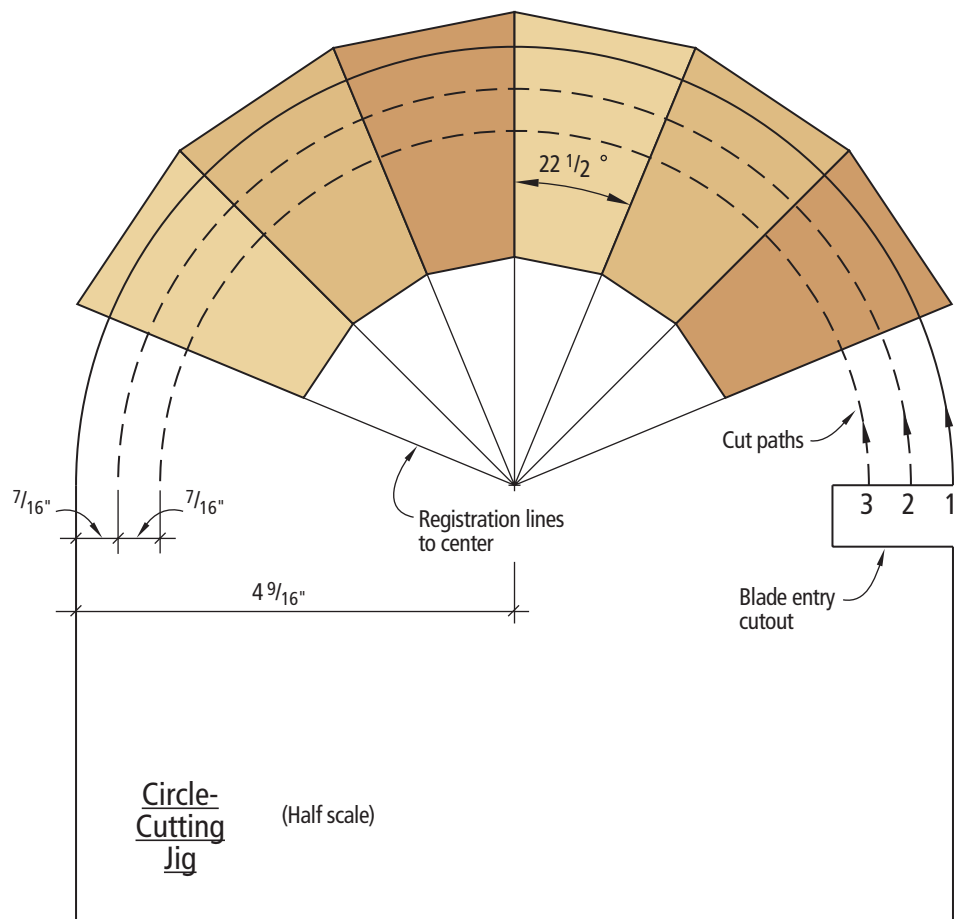

Dealing with Wood Movement

Eight ways to ensure the furniture you build will last several lifetimes.

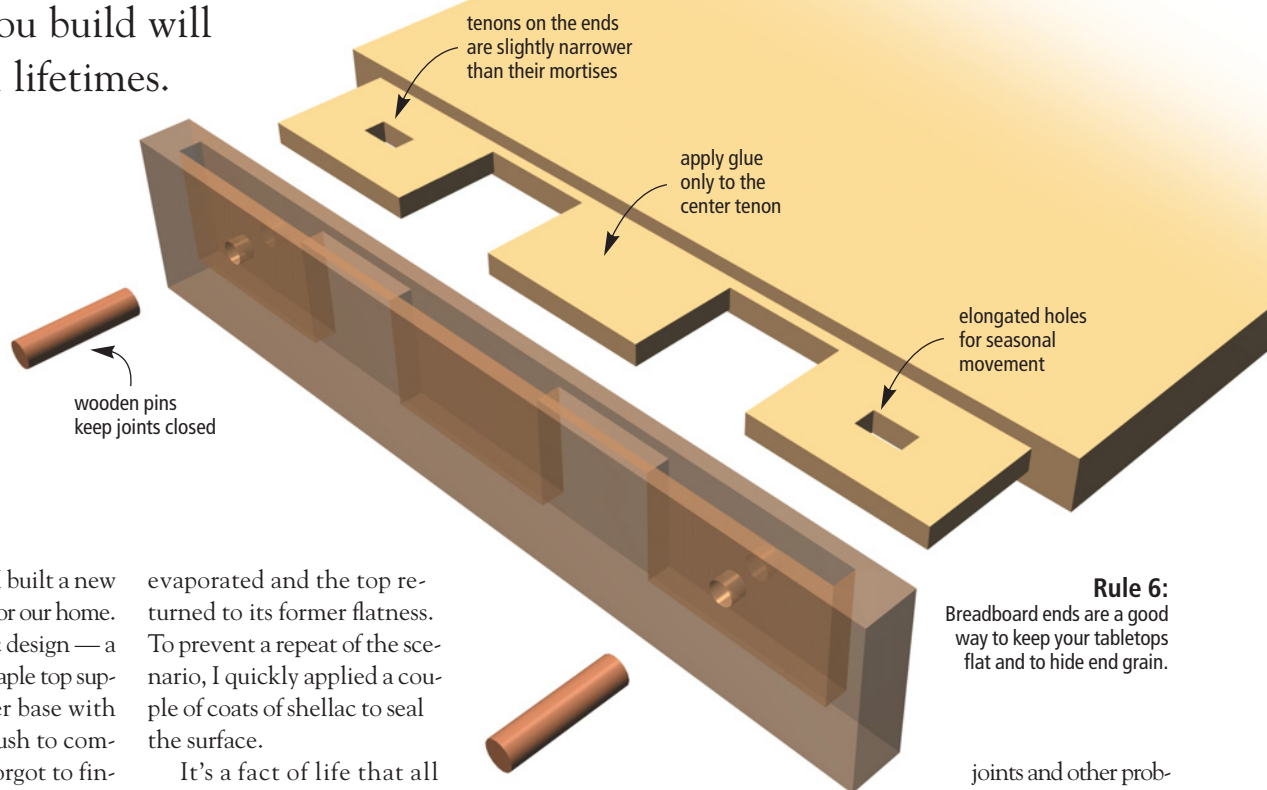

A few years ago I built a new kitchen table for our home. It was a classic design — a richly figured curly maple top supported by a stretcher base with turned legs. In my rush to complete the project I forgot to finish the underside of the top.

The next day the relative humidity rose dramatically as a storm front approached; I entered the shop to find the top severely cupped, in spite of the stiff breadboard ends added to keep the top flat. In fact, the breadboard ends were warped, too.

Fortunately, I knew what to do. The moment the sun came out I placed the top outside with the unfinished convex side facing up. After an hour or so out in the warm sunshine, the moisture

evaporated and the top returned to its former flatness. To prevent a repeat of the scenario, I quickly applied a couple of coats of shellac to seal the surface.

It's a fact of life that all woodworkers must face: Wood expands and contracts with changes in seasonal humidity. That's because wood is hygroscopic. What's hygroscopic? Simply a technical term for the concept that the wood's cell structure is similar to a bundle of straws, ready to draw moisture from the surrounding air. As the relative humidity goes up, wood absorbs the water vapor and expands. Days (or even weeks) later, it contracts as the relative humidity drops. To further complicate the prob-

lem, wood only moves across the grain. (Although technically speaking it does expand lengthwise with upswings in humidity, the amount is so minimal that you can safely ignore it.) So when you join two pieces of wood at a right angle, there's potential for problems because seasonal movement occurs in opposite directions. And because wood surfaces absorb and release moisture at different rates, a board will usually warp as it's exposed to changes in humidity. Fortunately, there are a number of steps you can take to minimize the cracking, warping, opened

Rule 6: Breadboard ends are a good way to keep your tabletops flat and to hide end grain.

joints and other problems associated with seasonal wood movement. Let's take a quick run through each of them.

1 Begin With Dry Lumber

You'll avoid many of the potential problems associated with wood movement if you use properly dried lumber. That's because as lumber dries, it also contracts or shrinks. Obviously it's best if it does most of the shrinking before you construct that chest of drawers for your wife's anniversary present. Think Levis jeans: They're pre-shrunk to avoid more shrinking during laundry cycles.

by Lonnie Bird

Lonnie Bird (lonniebird@earthlink.net) builds period furniture and conducts woodworking seminars in Dandridge, Tennessee.

In the same way, dried lumber is pre-shrunk so that it won't later contract and cause you grief.

So...how dry should the lumber be? The best moisture content (commonly referred to as MC) is one that places the lumber in equilibrium with your home's environment. Having the lumber in balance with the relative humidity of your home will dramatically reduce the amount the contraction (or expansion) that occurs. Want a hard number for moisture content? In most areas of the United States this equates to a 6 to 8 percent moisture content.

A common misconception floating around is that only kiln-dried lumber is suitable for fine woodworking. But the process used to dry the lumber is not as important as the final moisture content of the wood. In fact, I dry most of the lumber I use without using a kiln or other sophisticated machines. Here's how I do it: I usually buy my lumber as a great-looking log directly from a commercial logger. Buying the log allows me to get wide and thick boards that would cost a fortune and cost me hours of scrounging around a lumberyard. I have it custom-cut to my specifications, seal the ends of the boards, and stack them in a shed for drying. To promote drying, the boards are separated with sticks during the stacking. This allows air to circulate around the boards. After the lumber has dried in the shed to 15 percent MC (in equilibrium with outside relative humidity in my area), I store it on a rack in my shop to further dry it. Before using the lumber I always check the MC with a moisture meter. This small electronic device works by measuring the electrical resistance and converting it to MC. Lumber measuring higher than 8 percent MC

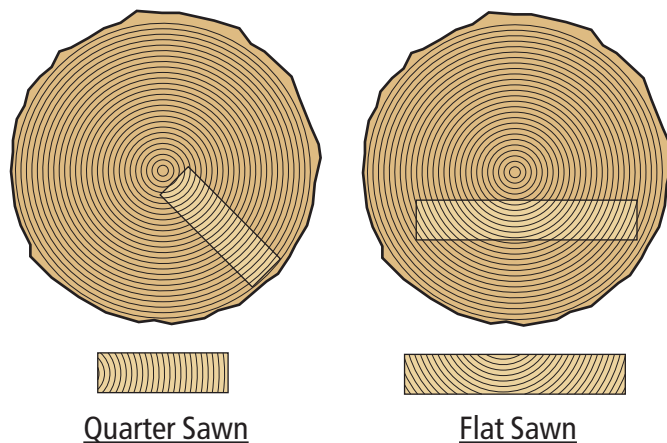

remains in the rack for more drying time.

4 Buying Dry Lumber

If you typically buy your lumber from a dealer, make certain that it is dry. Although most commercially available lumber is kiln dried, it may not be in the 6 to 8 percent MC range that is required to limit wood movement problems. Why? Most storage sheds at lumber yards are not heated. So if kiln-dried lumber has been stored in the shed for more than a few weeks, it's likely to absorb water vapor from the warm, moist, outside air. (Remember, wood is hygroscopic and it seeks equilibrium with its environment.)

So how can you avoid using lumber with a high MC? Always check it first with a moisture meter; for an accurate reading, also check the inside by sawing off a few inches from one end. Additionally, it's a good idea to always store lumber in your shop for a few weeks before working it. This allows it to acclimate to the environment in your shop and avoid potential movement problems.

5 Lumber Selection

Another way to minimize the natural contraction and expansion of wood is to select lumber that is naturally more stable. Because

wood moves different amounts in relationship to the annual rings, its tendency to move depends on how it is sawn from the log. Sort through a stack of boards and note the orientation of the annual rings on the ends. On most boards the rings form arcs that are tangent to the board's face. This is called tangentially sawn lumber (also called flat sawn). Lumber with rings that are roughly 90° to the board's face is referred to as radially sawn (often called quarter-sawn).

Radial lumber is much more stable than tangential. Because of this it's sometimes the best choice for broad, flat surfaces. For example, acoustical guitar bodies are made from radial-sawn lumber. However, radial lumber is usually more expensive when and if you can find it. Also, most people find the flame figure in flat-sawn lumber to be more attractive than the straight grain found in quartersawn boards.

4 Wide Boards Look Best

My old high school woodworking textbook said to never use boards over 6" wide. Wide boards, the author stated, would have a greater tendency to warp. But wide boards have continuity of grain, figure and color that can't be matched by gluing several boards together. Drawer fronts, desk lids, door panels and small tabletops will all turn more heads when constructed from one wide board. In fact, I commonly use boards up to 24" wide. So, how do I keep them flat and prevent surface cracks during the dry winter months?

I begin by allowing them to dry (pre-shrink) and warp before I use them. Afterwards, I flatten them to remove the warp before planing them to thickness. Then I use construction techniques that allow for inevitable wood movement.

Another old saw from woodworking textbooks is to alternate the annual rings when gluing up a tabletop. That is, put one board with the rings facing up, the next with the rings facing down and so on. This does little good. You're better off finding the best face of each board and choosing that side for the top.

5 Constructing for Movement

One of the best ways for dealing with seasonal wood movement is to use construction methods that allow for seasonal di-



MOISTURE METER

Few woodworkers own moisture meters, a tool that can save you from an occasional disaster. With this particular model, you merely set the meter on your wood to get a reading. Less expensive models have pins that you insert into the wood you're checking.

mensional changes. Probably the best known example is frame-and-panel construction. A flat panel is trapped within a groove in a stile-and-rail framework. Because the groove is deeper than the panel's width, the panel is free to expand as the relative humidity climbs. As an added advantage, the thick frame prevents the wide, yet thinner, panel from warping.

Because of its ability to span broad areas while providing dimensional stability, frame-and-panel construction has been popular for centuries. It's been used for doors, wall paneling and even casework. In fact, roll-top desks are constructed entirely from frame-and-panel assemblies.

And the frame-and-panel assembly can be adapted to fit within the design parameters of most any furniture design. For example, the frame can be dressed up with a simple moulding profile

along the inside edges. Where the moulding intersects in the corners it can be either mitered or coped. Coping works best to hide seasonal movement that occurs in wide rails. The panel can be flat, beveled (also called raised) or arched. I often use the panel as a place to show off wide, dramatically figured wood, such as crotch grain.

6 Breadboard Ends

Breadboard ends are another time-tested construction method for keeping a large panel flat, while still allowing for seasonal movement. (You'll still have to finish both faces of the panel — more on that in a minute.) Breadboard end construction is used on lids for desks and chests and wide tabletops.

It works like this: Strips of wood are attached cross-grain to the ends of a wide panel. During normal seasonal humidity changes, the breadboard ends prevent the panel from cupping because wood has greater stiffness along the grain than across the grain.

Although the breadboard ends solve the cupping problem, they can potentially create a new problem — restriction of seasonal expansion and contraction — in the panel.

The key is to allow the panel to "float" within the ends. Anytime you encounter cross-grain construction you must allow for movement. Restricting wood's natural movement will usually result in split boards and

open joints. So I attach the breadboard ends to the top with an odd number of mortise-and-tenon joints. By making the outer tenons slightly smaller in width than their corresponding mortises, the design allows the tenons to slide inside the mortises when the relative humidity changes. Also, I don't use glue in the joints because glue would restrict movement. So to keep the joints tightly closed I secure them with a wooden pin driven through the joint. I elongate the pin hole in the tenon, which allows the tenon to slide around the pin during humidity changes. During final assembly I apply glue only to the center joint; this forces the seasonal movement to occur equally on both edges.

7 Attaching Tabletops

Like other instances of cross-grain construction, tabletops must be firmly attached to the framework of the base while allowing for seasonal movement. The most common method is to use pocket screws.

A series of screws are driven through the edges of the aprons into the underside of the top. To hide the screws, they are driven at a slight angle and the screw head fits within a pocket on the inside of the rail. To allow for movement, the screw holes in the rails are elongated for a sloppy fit.

Other common methods to attach tabletops to bases include z-shaped clips that slide into a groove in the table's apron and shop-made wooden buttons that do the same thing.

Frame-and-panel, breadboard ends and pocket screws are just

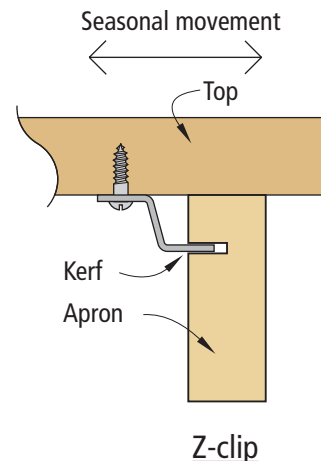

three construction methods you can use to deal with wood movement; each time you encounter cross-grain construction it presents a new challenge.

A final note on construction. Don't mill large, flat panels until you're ready to shape them. Otherwise they may warp slightly, making shaping and cutting joints difficult. For example, make the framework of a door first and dry assemble it to check for fit. Afterwards, cut the panel to size, shape it, and immediately fit it into the frame to keep it flat.

As an added precaution I'll wrap an assembly in plastic to prevent moisture exchange until time for finishing. I use the rolls of plastic available in hardware stores and home centers.

8 Seal the Wood

Sealing the surfaces of a board with a finish greatly limits the exchange of moisture. It's important, though, to seal all surfaces. Leaving a surface unfinished, like I did with my tabletop, can cause warping. This occurs because one face absorbs moisture at a much higher rate than the opposite face.

Finally, once the furniture is in the house, don't set it directly over a heating duct. Despite all your efforts, the continuous blast of hot, dry air can create serious wood movement problems. **PW**

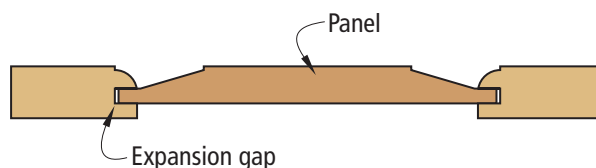
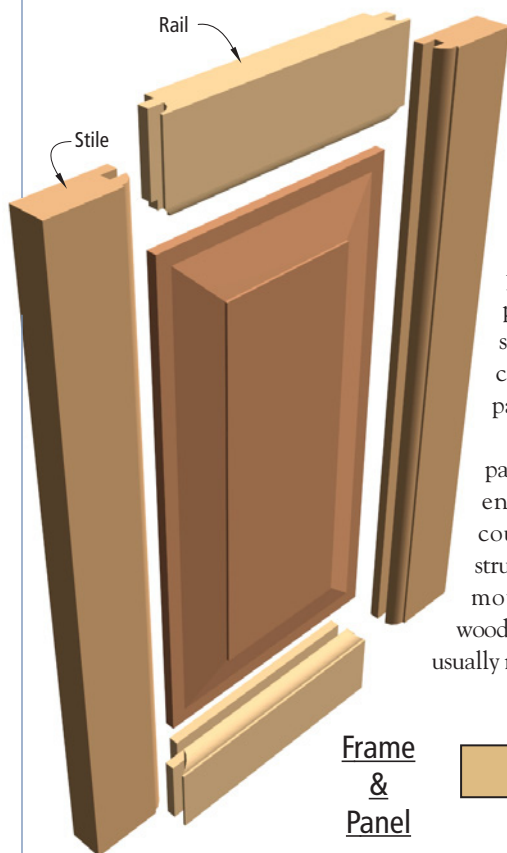

Make Beautiful Raised Panel Doors...

with a 1/4" or 1/2" router, and 1/2" or 3/4" shaper.

Plus, make many other types of doors and projects with our carbide tipped, production quality Raised Panel Door Sets, including: Flat Panel Doors, Kitchen Cabinet Doors, Cathedral Doors, Glass Doors, Wainscoting, Entertainment Center Doors. Sets include Combination Rail and Stile bit, and Raised Panel bit. For our FREE tips and techniques manual order item #9069.

#1438 Raised Panel Door Video\$9.95

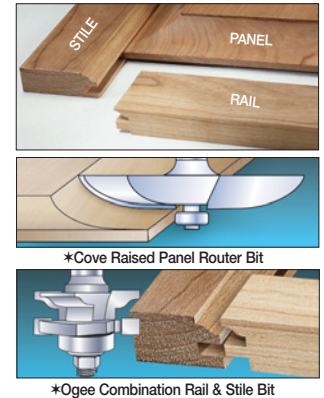

1/4" Shank Raised Panel Set

Carbide Tipped! Includes 2" dia. Cove Raised Panel bit with ball bearing and Ogee Combination Rail and Stile bit.

\$69⁹⁵
SET #1301

1/2" Shank Raised Panel Set

Carbide Tipped! Includes 3-1/2" dia. Cove Raised Panel bit with ball bearing and Ogee Combination Rail and Stile bit.

\$79⁹⁵
SET #1302

1/2" and 3/4" Shaper Set

Carbide Tipped! Includes 4-5/8" diameter Cove plus Ogee Combination Rail and Stile Shaper Cutters.

\$99⁹⁵
SET #1303

15 Piece Router Bit Set

MLCS Anniversary Set at a once-in-a-lifetime price!

Featuring these carbide tipped bits:

- 4 Straight (3/16", 1/4", 1/2", 3/4"),
- 1 Cove (1/2")
- 1 Round Over (3/8"),
- 1 Roman Ogee (5/32")
- 1 14° Dovetail (1/2"),
- 1 Rabbeting (3/8")
- 1 Panel Pilot
- 1 45° Chamfer,
- 1 Flush Trim (1/2"),
- 1 Hinge Mortising (1/2"),
- 1 Round Nose (1/4")
- 1 V-Groove (3/8")
- 1 allen wrench and
- 1 bearing to convert Round Over into Beading bit.



\$39⁹⁵
1/4" Shank • #1442
1/2" Shank • #1443

WOOD STORAGE BOX INCLUDED

30 Piece Router Bit Set

Celebrate our Anniversary by saving money!

Featuring these carbide tipped bits:

- 3 Cove (1/4", 3/8", 1/2"),
- 2 Flush Trim (3/8", 1/2")
- 6 Round Over (1/8", 3/16", 1/4", 5/16", 3/8", 1/2")
- 5 Straight (1/4", 5/16", 3/8", 1/2", 3/4")
- 1 Chamfer (45°),
- 1 Slot Cutter (1/4"),
- 1 Rabbeting (3/8")
- 1 V-Groove (1/2"),
- 1 Bevel (25°)
- 1 Panel Pilot (3/8")
- 3 Round Nose (1/4", 3/8", 1/2"),
- 3 Dovetail (14°-1/2", 5/8" & 9°-3/8")
- 2 Roman Ogee (5/32", 1/4")
- 1 Allen Wrench and 1 bearing to convert Round Over into Beading bit.



\$99⁹⁵
1/4" Shank • #1444
1/2" Shank • #1445

WOOD STORAGE BOX INCLUDED

66 Piece Router Bit Set

An amazing price for our most complete set!

- Includes the 30 Piece Set (left) plus these bits:
- Straight (7/16", 5/8", 1"), 1 Bevel (30°),
- 1 Groove Forming Classical (3/4"), 1 Keyhole (3/8"),
- Hinge Mortising (1/2", 5/8", 3/4"), Classical Bit (3/16" r),
- 3 Core Box (1/4", 3/8", 1/2"), 1 Dish Cutter (1"),
- V-Groove (3/8", 5/8"), Cove (1/8", 3/16", 5/16"),
- 1 Flat Bottom Sign Lettering (5/8" 60°),
- 1 Double Cove & Bead, 1 Ogee Filet (1-3/8"), 1 Cove and Bead (5/16" r), 2 Edge Beading (1/4", 3/8"),
- Dovetail (7.5°-1/4", 14°-3/4), Slot Cutter (3/8")
- 1 Point Cutting Round Over (1/2"),
- 1 Flat Bottom Round Over (1/4" r),
- 1 Multi Bead/Reed Bit (1/8" r),
- 1 Double Round Over (5/32" r),
- 1 Cove Sign Lettering (5/8" 60°),
- Chamfer (30°, 22.5°, 15°),
- 4 bearings & allen wrench



\$224⁹⁵
1/4" Shank • #1446
1/2" Shank • #1447

WOOD STORAGE BOX INCLUDED

Safety Small Parts Holder

Eliminate danger when working with small parts. Securely positions and aligns small parts with quick release clamping action, preventing slipping and keeping fingers away from sharp cutting edges. Large, easy-to-grip handles guarantee precision and control when custom-shaping small pieces. Handles wood stock up to 10" and any cut angle up to 45 degrees. Works for router or saw tables, drill presses, band saws, joiners and more. Great for toy parts, door rail ends, and other detail jobs that would be dangerous or impossible without it.



\$19⁹⁵
ITEM #1451

6 Piece Cabinetmaker Router Bit Set

1/2" shank Carbide Tipped set. Make kitchen cabinets, raised panel doors, table tops and drawers. For up to 3/4" wood. Includes these bits:

- Glue Joint (1-3/4")
- Drawer Lock (1-3/4")
- Rail & Stile Matched Pair (1-5/8")
- Ogee Raised Panel (2-3/4")
- Round Over & Ogee Door Lip (1-1/4")



\$114⁹⁵
SET #1452

WOOD STORAGE BOX INCLUDED

16 Piece Forstner Bit Set

Includes these sizes:
1/4", 3/8", 1/2", 5/8",
3/4", 7/8", 1",
1-1/8", 1-1/4",
1-3/8", 1-1/2",
1-5/8", 1-3/4",
1-7/8", 2", 2-1/8".



\$43⁹⁵
SET #1418

WOOD STORAGE BOX INCLUDED

1-800-533-9298

FREE CATALOG • Order securely online at:
mlcswoodworking.com

MLCS
ROUTER BITS AND PROFESSIONAL WOODWORKING PRODUCTS

FREE Shipping!
IN CONTIGUOUS USA FOR ALL ITEMS



MLCS, P.O. Box 4053PC, Rydal, PA 19046



ASIAN

Bedside Table

This frame-and-panel project is all about grooves, tongues and ancient proverbs.

Building cabinetry can give you a serious case of Zen Buddhism. In fact, the contradictions in woodworking are sometimes amusing — if not enlightening. Cabinets, for the most part, are more air than wood.

To build a piece of furniture is mostly a process of removing wood. And to make a project look as simple and plain as this one does, it is quite a complicated process.

Now before you start worrying that this simple bedside table is too much for your woodworking skills, remember my favorite Bulgarian proverb: “If you wish to drown, do not torture yourself with shallow water.”

Frames and Panels

Except for two small pieces of plywood in the sliding doors, this project is made entirely out of solid wood. To account for the seasonal expansion and contraction of the material, the table is built using a series of frame-and-panel assemblies. In a nutshell, all of the frames are connected using mortise-and-tenon joinery. The panels all rest in $\frac{3}{8}$ "-wide x $\frac{3}{8}$ "-deep grooves in the frames. After you have milled all the parts using the cutting list and glued up any panels you might need, I recommend you begin by building the doors.

Lightweight but Solid Sliding Doors

The sliding doors on this table run in $\frac{1}{4}$ "-wide x $\frac{1}{4}$ "-deep grooves cut into the frame pieces. Once this table is glued up, the doors are in

there for good. (You can easily make the doors removable by deepening the grooves in the top rail and increasing the width of the tongue on the top of the doors.) To ensure the doors slide smoothly for years to come, choose straight-grained stock for the parts.

The rails and stiles of the doors are joined using mortises and tenons. The plywood panel rests in a rabbet cut in the back of the door, and the slats are merely glued onto the panel.

Begin by cutting your $\frac{1}{4}$ "-thick x 1"-long tenons on the rails. As you can see in the photo on the next page, the shoulders facing the outside edges of the door are $\frac{1}{2}$ " bigger than the ones facing inside. This makes a cleaner-looking joint when you cut the tongue on the top and bottom of the door. Now cut the matching mortises in the stiles. Glue and clamp the doors.

When the glue is dry, cut a $\frac{1}{4}$ "-deep x $\frac{3}{8}$ "-wide rabbet on the backside of each door. Square the corners with a chisel. Finish sand the $\frac{1}{4}$ " birch plywood panel and then glue it in the rabbet. When that glue is dry, glue the slats in place spaced 1" apart.

Finally, to complete the doors cut a $\frac{1}{4}$ "-thick x $\frac{3}{8}$ "-long tongue on the top and bottom edge of the backside of the doors.

The Case

Begin work on the case by cutting $\frac{1}{2}$ "-thick x 1"-long tenons on all the rails with a $\frac{1}{4}$ " shoulder all around. Now use your tenons to lay out the locations of the mortis-

We shape clay into a pot, but it is the emptiness inside that holds whatever we want.

—Lao Tzu, Zen saying

by Christopher Schwarz

Comments or questions? Contact Chris at 513-531-2690 ext. 407 or chris.schwarz@FWPubs.com.

BEDSIDE TABLE

NO. ITEM DIMENSIONS (INCHES) MATERIAL
T W L

Top

□	2	Top stiles	1 ³ / ₄	1 ³ / ₄	30	Maple	3/8" x 3/8" groove on inside edge
□	2	Top rails	1 ³ / ₄	1 ³ / ₄	18	Maple	1" TBE, 3/8" x 3/8" groove on inside edge
□	1	Panel	3/4	16 ¹ / ₂	20 ¹ / ₂	Maple	in 3/8" x 3/8" groove; 1/2" x 3/8" rabbet, all sides

Base

□	4	Legs	1 ³ / ₄	1 ³ / ₄	23	Maple	3/8" x 3/8" groove for side & back panels
□	4	Rails for sides	1	1 ¹ / ₂	14	Maple	1" TBE, 3/8" x 3/8" groove for side panels
□	3	Rails frt & bk	1	1 ¹ / ₂	22	Maple	1" TBE, 3/8" x 3/8" groove for back panel
□	1	Front bottom rail	2	1 ¹ / ₂	22	Maple	1" TBE
□	2	Top & bot panels	3/4	12 ³ / ₄	20 ³ / ₄	Maple	1/2" x 3/8" rabbet on edges; rests in 3/8" x 3/8" groove
□	2	Side panels	3/4	12 ⁵ / ₈	12 ⁵ / ₈	Maple	1/2" x 3/8" rabbet on edges; rests in 3/8" x 3/8" groove
□	1	Back panel	3/4	12 ⁵ / ₈	20 ⁵ / ₈	Maple	1/2" x 3/8" rabbet on edges; rests in 3/8" x 3/8" groove

Doors

□	4	Stiles	1/2	1 ¹ / ₂	12 ¹ / ₂	Maple	
□	4	Rails	1/2	1 ³ / ₄	9 ¹ / ₂	Maple	1" TBE
□	2	Panels	1/4	8 ¹ / ₄	9 ³ / ₄	Ply	in 1/4" x 3/8" rabbet on back of door
□	8	Slats	1/8	1	7 ¹ / ₂	Maple	applied to panel

KEY: TBE= tenon on both ends.

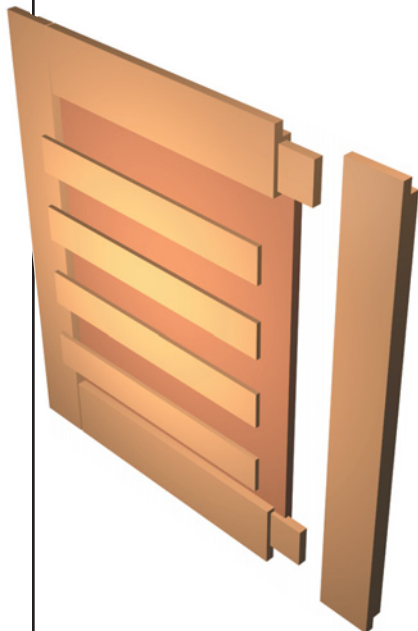

You can see the large shoulder on the door tenon here as I'm dry-fitting the door. The large shoulder makes for a cleaner-looking tongue.



You know, I really should install a starting pin in my router table for making cuts like these. If you take it slow and steady, you shouldn't have any problems. Just make sure you cut against the rotation of the cutter.

es on the legs. You want all of your rails to be set back 1/8" from the outside edge of the legs.

The only anomaly comes when laying out the mortises for the beefy front bottom rail. Its mortises run vertically instead of horizontally.

Cut the 1/16"-deep mortises. I used a hollow-chisel mortiser equipped with a 1/2" bit. As you'll see when you get into it, cutting these mortises is a bit different than in most case work. You'll clamp your work to your mortiser's fence and then move the fence in and out to cut the mortises (except when cutting the mortises for the front bottom rail, which

QUICK TIPS: STRATEGIES FOR RIDDING YOUR JOINTS OF GAPS

When you do a lot of mortise-and-tenon work, one of the most frustrating aspects of the joint is getting a seamless fit. Here are a few tricks to ensure fewer gaps.

1. Pay attention to the edge of the board that the mortise is in. If you sand or plane this surface before assembly, chances are you're going to change the angle of the edge, which will give you a gap when you assemble the joint. Before I cut a mortise in an edge, I run it over my jointer slowly to remove any saw marks. After the joint is glued and assembled, I go in and clean up the jointer marks with 120-grit sandpaper.
2. On highly visible joints, I'll put the tenoned piece in my vise and go to work on it with a chisel. Pare away at the shoulder area around and up to the tenon — but stay away from the edge. You only need to remove 1/32" of material or so.
3. Make your mortises 1/16" deeper than your tenons are long. This stops your tenons from bottoming out in the mortises and gives any excess glue a place to collect.



On the door slats, I cheated. I didn't feel like mortising the really thin stock into the stiles. To ensure your spacing is correct, use a couple of 1"-wide spacers to place your slats. A piece of tape on mine shimmed the spacers a bit to ensure the slats were equally spaced.

are cut conventionally). Finally, miter the tenons so they fit in the mortises without bumping into each other.

Two Grooves for Every Rail

There are lots of grooves on the rails and in the legs. One way to cut them all is using a $\frac{3}{8}$ " straight bit and a router table setup. However, I like to see what's going on when I cut grooves like these. So I used an aftermarket edge guide on my router. I prefer the Micro Fence for work such as this because it allows me to sneak right up on the perfect measurement with its microadjustable knob. Other edge guides are capable of the job, however.

Set your $\frac{3}{8}$ " straight bit so it will make a $\frac{3}{8}$ "-deep cut and set your fence so the bit is $\frac{3}{16}$ " from the outside edges of the rails, cut the $\frac{3}{8}$ " x $\frac{3}{8}$ " grooves on all the rails that hold the panels (except for the groove in the bottom front rail that holds the bottom panel). To cut that groove, set the distance between the fence and bit to $\frac{7}{16}$ " and fire away. See the drawings for more details.

Now cut the grooves in the legs for the panels. Set your bit so it's $\frac{5}{16}$ " from the fence and essentially connect the mortises.

Now it's time to cut the two grooves in the two front rails that the doors ride in. Chuck a $\frac{1}{4}$ " straight bit in your router and cut the grooves in the top and bottom rails as shown in the drawings at right.

To make the panels fit in their grooves, cut a $\frac{3}{8}$ "-deep x $\frac{1}{2}$ "-long rabbet on the underside of all the panels. You're going to have to notch the corners of each panel to fit around the legs. Cut the notches using a back saw.

Finish sand all the parts for the case and get ready for assembly. Check the fit of the doors in

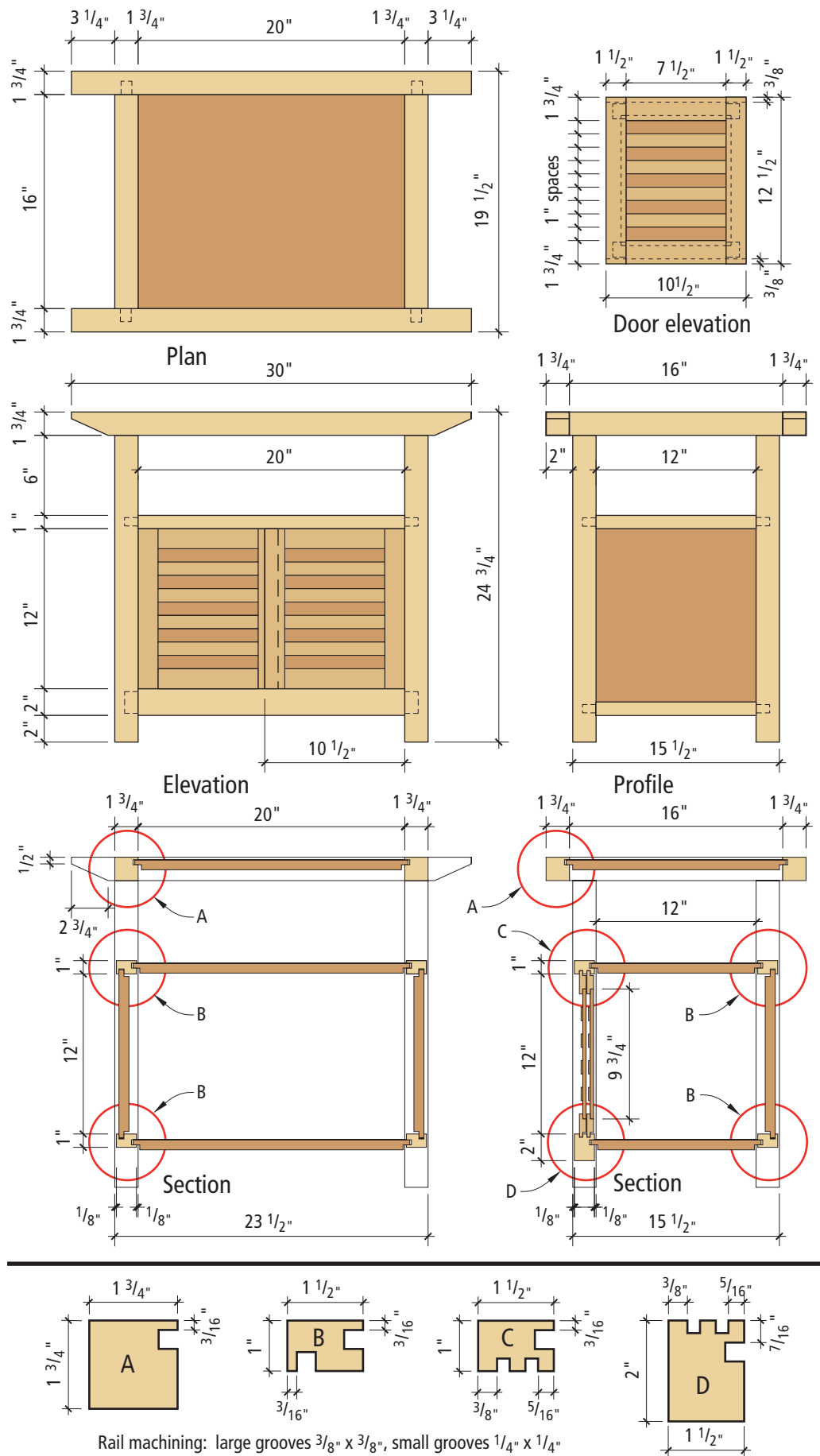



Again, when cutting the grooves, you want to move the router in the direction opposite the rotation of the cutterhead. In this instance, this means moving the router from left to right.

the grooves. A couple passes with a shoulder plane on the tongues made my doors slide smoothly. Once everything fits, glue the side assemblies up. Put glue in the mortises, but not in the grooves. You'll want to finish everything before final assembly, so set the side assemblies and the rest of the parts aside for later.

The Top: Still More Grooves

The top is made much the same as the sides. First cut the 1/2"-thick x 1"-long tenons on the ends of the rails. Cut the mortises to match in the stiles. Get out your router and your fence again, chuck the 3/8" straight bit in there and set the distance between the bit and the fence to 3/16" (this will make

the top recessed into the frame). Set the depth of cut to 3/8" and cut the grooves in the rails and the stiles.

Cut the detail on the ends of the stiles as shown in the drawings. I cut it using my band saw and cleaned up the bevel using a plane. Finally, cut a 3/8"-deep x 1/2"-long rabbet on the bottom side of your panel. Finish sand all the parts and glue up the top frame.

Finish and Fit

Before finishing, apply masking tape to all the tenons and plug the mortises with packing peanuts. Apply three coats of a clear finish, such as clear shellac or lacquer, and sand between each coat. When the finish has fully cured,

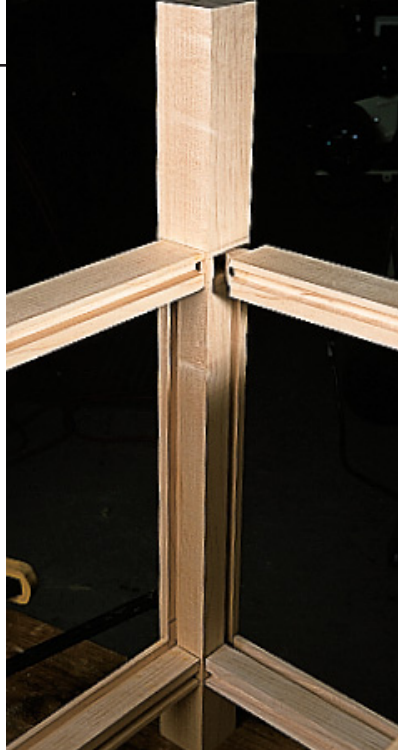

Here's where it all comes together. You can see the grooves for the panels in the rails and legs and the mitered tenons.

SUPPLIES

Rockler
www.rockler.com
800-279-4441

Desktop fasteners,
item # 21650, \$3.99 for
a package of eight.

Micro Fence
www.microfence.com
1-800-480-6427

assemble the case. Apply glue in the mortises, slide the doors in place and clamp it up. Check the case for square across the height and depth of the case. When the glue is dry, attach the top using desktop fasteners (sometimes commonly called "figure-8" fasteners). With a 3/4" Forstner bit chucked into your hand drill, cut a recess for the fastener in the top of each leg. Screw the fasteners to the legs. Then screw the case to the underside of the top.

Whenever I finish a project

such as this, I can't help but look askance at the tiny imperfections (unnoticeable to most people) that come from handwork. But then I try to remember another Zen saying from Ts'ai Ken T'An that should comfort all woodworkers: "Water which is too pure has no fish." **PW**



My large shoulder plane is probably one of the most useful tools in my shop. It trims tenons and deepens rabbets better than anything else out there. The original Record 073 (now out of production) sells used for several hundred dollars. I bought my Lie-Nielsen version for \$225. Pricey? Yes, but well worth it. When you trim the tongues on the doors, make sure you have something backing up your cut or you will blow out the grain at the end.

BOOKSHELF

If you're interested in Asian furniture, tools and construction methods, I recommend the following books available from The Japan Woodworker, 800-537-7820:

"The Complete Japanese Joinery" by Hideo Sato, item # 03.241, \$29.95

"The Art of Japanese Joinery" by Kiyosi Seike, item # 03.009, \$16.95

"Traditional Japanese Furniture" by Kazuko Koizumi, item # 03.195, \$85

"Japanese Woodworking Tools: Their Spirit, Tradition and Use" by Toshio Odate, item # 03.250.25, \$24.95

Free Kit Catalog.

100% Money Back Guarantee.



Heirloom Quality Kits for Clocks & Furniture

Grandfather, Mantel & Wall Clocks

Solid Oak, Walnut & Cherry

Assembled Products Available



1-800-642-0011
www.emperorklock.com
Department 8005, P.O. Box 1089
Fairhope, AL 36533

Circle #106 on Reader Service Reply Card

Ad Code: PW0201

Proud to be **AMERICAN**
Over **650** Different Professional Quality Router Bits...
All Made in the U.S.A.

FREE WOODWORKING CATALOG

Largest selection of the best made bits in America plus 100's of unique, hard-to-find tools and accessories. Get your copy today!

EAGLE AMERICA P.O. Box 1099 • Chardon, OH 44024
800-872-2511
www.eagle-america.com

Circle #104 on Reader Service Reply Card

Incra Miter1000

SALE \$89

Produce perfect, gap-free miter joints on virtually any multi-sided object with the new, Incra Miter1000. A 1st rate upgrade miter gauge with Incra's legendary accuracy.

- 41 Indexed angle stops over +/- 90° range
- 18" Incra Track Fence with Slide Stop
- Steel GlideLOCK™ Miter Bar with 6 Width Adjustment Points
- Patented Incra Accuracy

Woodpeckers Inc.
Precision Router Tables & Accessories
1.800.752.0725 • www.woodpeck.com

Circle #133 on Reader Service Reply Card

STATEMENT OF OWNERSHIP, MANAGEMENT AND CIRCULATION (required by Act of August 12, 1970: Section 3685, Title 39, United States Code). POPULAR WOODWORKING is published six times a year at 1507 Dana Avenue, Cincinnati, Ohio 45207. The general business offices of the publisher and the editor are: Publisher and Editor, Stephen Shanesy, 1507 Dana Avenue, Cincinnati, Ohio 45207. The owner is F&W Publications, Inc.; Stephen J. Kent, President and CEO. Address: 1507 Dana Avenue, Cincinnati, Ohio 45207. The extent and nature of circulation is: A. Total number of copies printed (Net press run). Average number of copies each issue during preceding 12 months 237,572. Actual number of copies of single issue published nearest to filing date 228,200. B. Paid circulation. 1. Sales through dealers and carriers, street vendors and counter sales. Average number of copies each issue during the preceding 12 months 43,019. Actual number of copies of single issue published nearest to filing date 49,415. 2. Mail subscriptions. Average number of copies each issue during preceding 12 months 150,879. Actual number of copies of single issue published nearest to filing date 136,994. C. Total paid circulation. Average number of copies each issue during preceding 12 months 193,898. Actual number of copies of single issue published nearest to filing date 186,409. D. Free distribution by mail, carrier or other means. Samples, complimentary and other free copies. Average number of copies each issue during preceding 12 months 239. Actual number of copies of single issue published nearest to filing date 230. E. Total distribution (Sum of C and D). Average number of copies each issue during preceding 12 months 194,137. Actual number of copies of single issue published nearest to filing date 186,639. F. 1. Office use, leftover, unaccounted, spoiled after printing. Average number of copies each issue during preceding 12 months 3,151. Actual number of copies of single issue published nearest to filing date 1,257. 2. Returns from news agents. Average number of copies each issue during preceding 12 months 40,284. Actual number of copies of single issue published nearest to filing date 40,304. G. Total (Sum of E and F should equal net press run shown in A). Average number of copies of each issue during preceding 12 months 237,572. Actual number of copies of single issue published nearest to filing date 228,200. I certify that the statements made by me above are correct and complete. Filed October 1, 2001. Stephen Shanesy, Publisher.

ADVERTISER INDEX

	READER SERVICE	PAGE #		READER SERVICE	PAGE #
Adams Wood	#100	16	Leigh Industries	-	55
Baker Products	#149	92	Makita	#128	Cvr 3
Bench Dog	#117	6	MLCS	#109	71
Bunk Beds	#141	92	Niagara Lumber	#143	25
Clayton	#102	6	Nyle Corporation	#129	16
Controlled Energy	#118	14	Oneida Air Systms	#137	55
Country Crafts	#142	92	Osborne Wood	#110	21
Craftsman	#130	12,13	Packard Woodworks	#144	92
Cupboard Distributing	#152	92	Polymeric Systems	#151	92
Dakota Alert	#138	92	Porter-Cable	#116	28,29
Datco	#103	11	Price Cutter	#111	23
Delta	#119	Cvr 4	Quick Grip	#101	2
Dover Publications	#145	92	Rockler	#112	25
Eagle America	#104	77	Routerbits.com	#148	92
Econ Abrasives	#120	21	Smithy	#113	10
Emperor Clock	#106	77	Suffolk Machinery	#139	92
Fein Power Tools	#121	7	U-Bild	#146	92
Franklin Int'l	#105	5	US Buildings	#140	92
Freud, Inc.	#122	61	West Penn	-	25
Gorilla Glue	#127	11	Wilke Machinery	#131	35
Granbergs	#150	92	Wood Wizard	#132	21
Grizzly Imports	#123	Cvr2	Woodcraft Supply	#114	11
Grizzly Imports	#124	1	Woodcraftplans.com	#147	92
Heritage Building System	-	92	Woodline Arizona	#115	15
HTC Products	#107	6	Woodpeckers Inc.	#133	77
JET Tools, Inc.	#126	9	Woodpeckers Inc.	#134	10
Klockit	#108	35	Woodpeckers Inc	#135	21
Kreg Jig	#136	55	Woodstock International	#125	26
Lee Valley Tools	-	14,35			

A



LAMP

CALLED WANDA

Add another useful pet to your household with this clever basket of a fish.

The tongue-twisting term *bioluminescence* translates to the production of light by living organisms. Bioluminescent fish light up to lure prey, defend themselves and attract other fish. The majority of such fish are found in the deepest regions of the ocean in a realm of perpetual darkness. Wanda (genus *Happy woodfishium*), the glowing subject of this article, was unexpectedly hatched in broad daylight at an altitude of 837 feet above sea level in the rolling hills of Delaware, Ohio. Talk about a fish out of water. Although relieved from the day-to-day lantern fish responsibilities of luring, defending and attracting, she stands ready to provide just the right touch of mood lighting for the author and his family.

Backbone

As with any good vertebrate, a backbone is the key to a successful Wanda. The pine backbone is the same shape as the first rib as shown in the drawing. All the drawings are half-scale. Enlarge them 200 percent to make them full size. Because I didn't have stock wide enough to create the required 9" x 12" oval, I cut two 4½" x 12" C-shapes from ½" clear pine and glued them together with joints at the head and tail. Don't sweat less-

than-perfect joints. The fins, head and tail will cover them.

Ribs

Apply two body patterns to ¼" Finnish birch (Baltic birch or Appleply will also work) plywood. A 12" x 36" sheet will fill the bill. Drill all the ⅜" dowel holes. With a scroll saw, play connect-the-dots and cut out the ribs and the outer oval. Nest the ribs and oval, keeping the original face-grain orientation. Apply small tabs of electrical tape to the front tops to keep it all sorted out. Glue the largest of the basket-like shapes to the backbone.

Dowels

Cut 96 (that's right, 96) ¾" lengths of ⅜" dowel. Since it is important that the ends of the dowels are square, I used a micro miter box with a stop clamped in place.

Body Half Assembly

On each rib, glue the dowels in the inner notches. Make sure they are plumb and flush with the bottom of the strip. Slide a small rib down over the dowels on a larger rib until the top ¼" of the dowels is exposed. With a small brush, apply glue to the inside of the exposed dowels. Now pull the small rib up until it is flush with the top of the

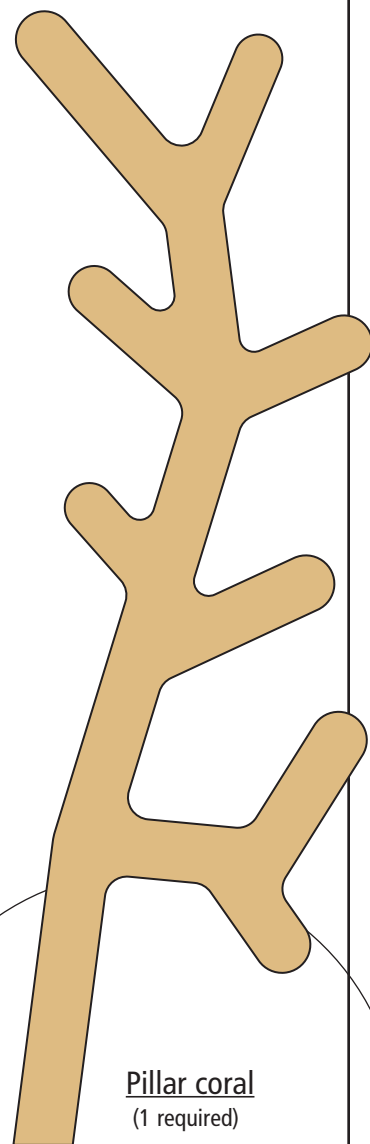

Pillar coral
(1 required)

by John W. Hutchinson

After nearly exhausting the realm of land animals to depict in his wooden creations, John has turned to the sea for inspiration. A Lamp Called Wanda will soon be followed by a wind-driven exercise in octopus behavior. We'll give you a little shore leave to rest up for that one.



Enlarge the patterns to full size at your local copy store (yes, Copy Store person, you have our permission to reproduce this copyrighted material). Adhere the patterns to your plywood using a spray adhesive or rubber cement and then drill all the $\frac{3}{16}$ " holes using your drill press. Then it's just a matter of connecting the holes by cutting on the lines.

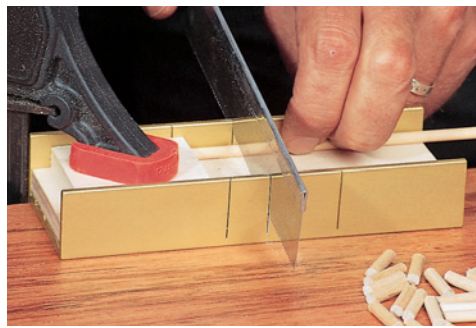

This small-size miter box and the gent's saw are available for sale at most woodworking stores. They are the key to cutting the 96 dowels with square ends. I clamped a stop block in the miter box to ensure all the dowels were the same length.

To assemble the basket sides, first glue one of the two largest ribs to your backbone. Glue the eight $\frac{3}{4}$ "-long dowels in notches in this rib with $\frac{1}{2}$ " protruding from the rib.

Once the glue is dry, press-fit the next larger rib into the dowels and push it down so $\frac{1}{4}$ " of each dowel is exposed.

Using a brush, paint the inside face of each dowel with yellow glue (right).

Now raise the rib into position (far right).

While waiting for this rib to dry, work on the rib on the other side of the basket.

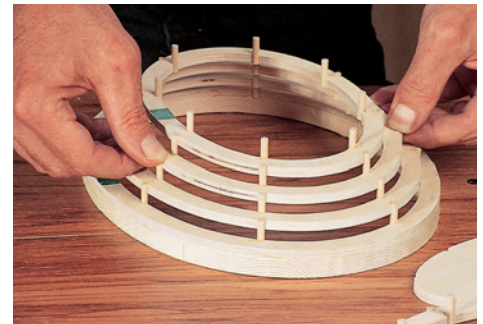
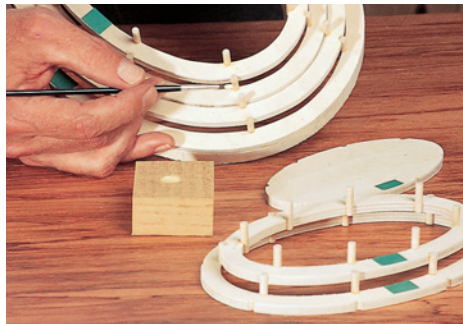

dowels. When this first sub-assembly has dried, slide it down and over the dowels protruding from the next largest rib, apply glue to the dowels and pull up. Continue this process until you've created two "baskets." Work back and forth between the two body halves, allowing the glue to dry as you go.

Appendages

Laminate two layers of $\frac{1}{4}$ " plywood to create $\frac{1}{2}$ " stock for the head, fins and tail. Apply the patterns and cut them out on the scroll saw. Drill the eye sockets and insert $\frac{3}{8}$ " walnut screw hole buttons. Glue the appendages to the backbone.

Base

While it would be easy to run out and purchase a gorgeous chunk of coral for the lamp base, doing so would only hasten the demise of one of Mother Nature's treasures. It's satisfying, and a lot of fun, to create your own underwater kingdom from scraps of wood and dowel lying around the shop. For the mound of brain coral that anchors the lamp, I used 1x cherry. Apply three patterns for the successive layers to the stock. Bore the grid of $\frac{1}{4}$ "-deep "cups" with a $\frac{3}{8}$ " Forstner bit.

With the same

bit, drill the perimeter through-holes. After the drilling is complete, it's again time to play connect-the-dots with the scroll saw. Glue up the three-layer coral with the help of $\frac{3}{8}$ " alignment dowels inserted into a few of the cups. The pillar coral and turtle grass are cut from a contrasting wood. I used clear cedar.

The brain coral is backed up by three joined semicircles. Some scrap 1x oak was the wood of choice here since it added heft to the base. As shown in the patterns, scroll saw the centers out of the

two outer disks. The cavities provide a place for the wiring connections. The smallest semicircle becomes the removable cap. Drill a small hole in the cap for the lamp cord. Glue the larger pieces together and attach the cap with brass wood screws. Drill a $\frac{3}{8}$ " hole through the large disk and epoxy a length of copper pipe into the hole with 14" protruding. Drill a series of angled holes, again in the large disk, to house the $\frac{1}{4}$ " dowel reeds. Finally, center and glue the semicircle assembly on the back of the brain coral.

Lamp Holder

Cut out two lamp holder disks from $\frac{1}{2}$ " stock. Position cop-

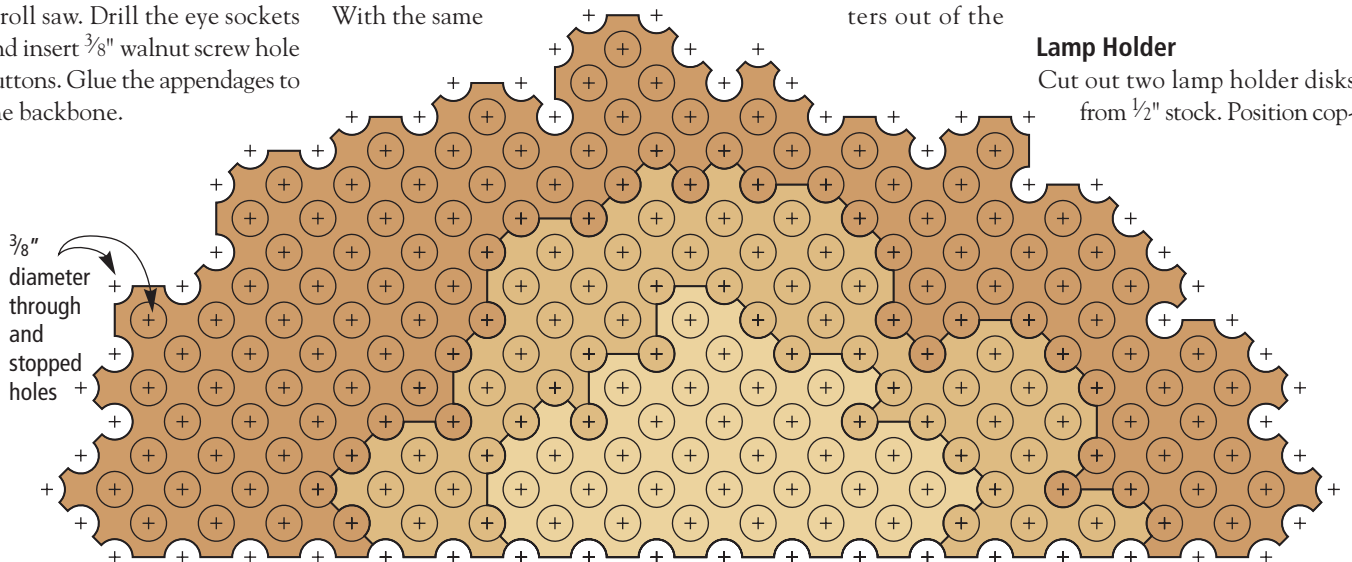

3-layer brain coral

half-scale drawing

SUPPLIES

- 24" length of $\frac{3}{8}$ " o.d. copper tube, two T-fittings, one tube cap
- Two candelabra bulb sockets
- Two candelabra base frosted bulbs, 30 watts or less
- Lamp cord and plug
- In-line lamp switch
- Brass wood screws

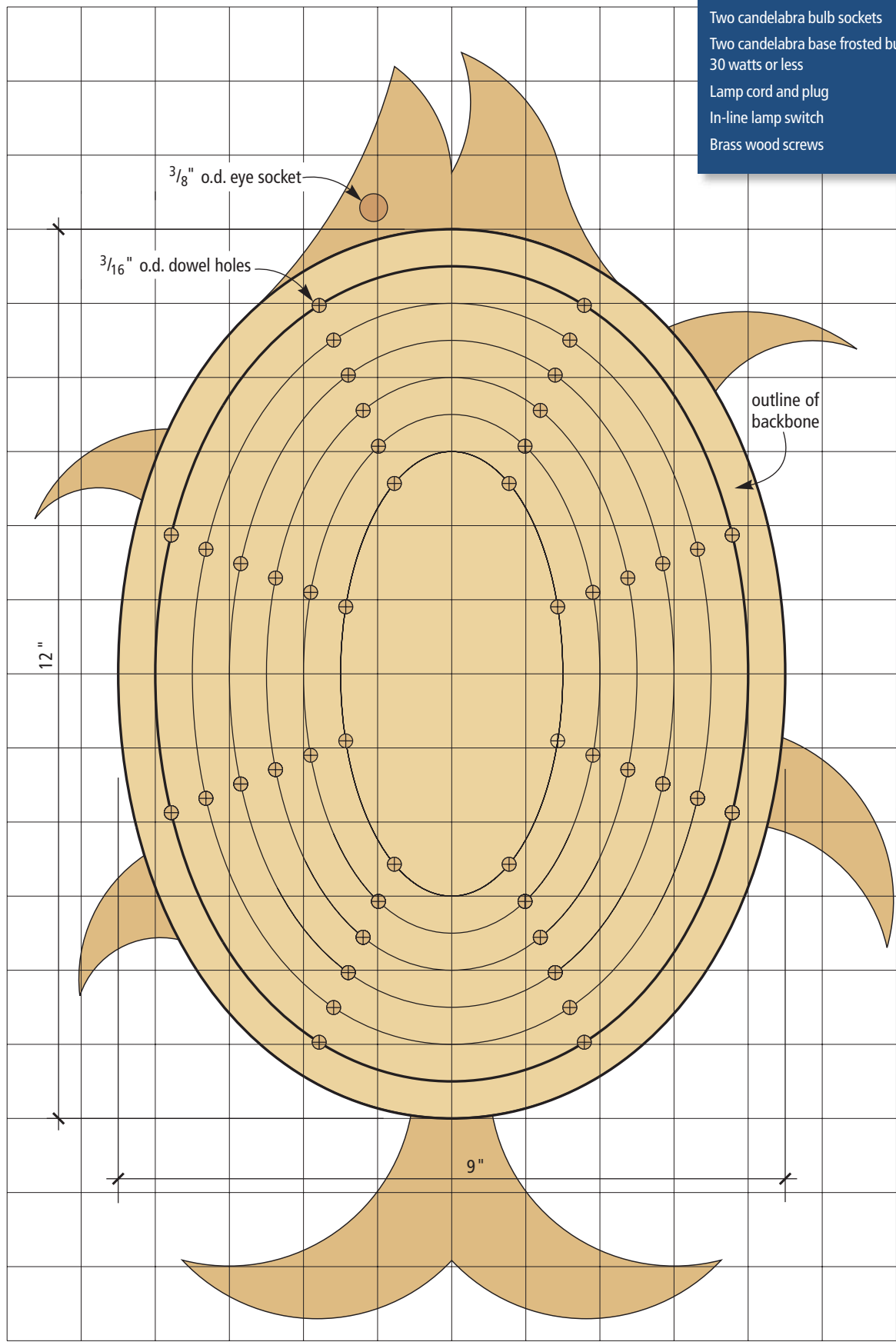

Half-scale drawing; enlarge 200 percent for full-size



Making the "coral" base is mostly a matter of drilling holes. Adhere the patterns to three pieces of wood and chuck a $\frac{3}{8}$ " Forstner bit in your drill press. The holes on the edges of the coral go all the way through the piece; the holes in the middle are $\frac{1}{4}$ " deep.

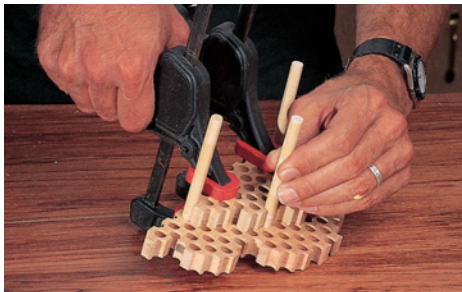

Use $\frac{3}{8}$ " dowels to line up the pieces of coral when you glue them up. Don't use too much glue because it's difficult to clean up squeeze-out in these holes.



The two wooden pieces of the lamp holder are joined by copper "tees" epoxied into holes drilled through the wooden circles.

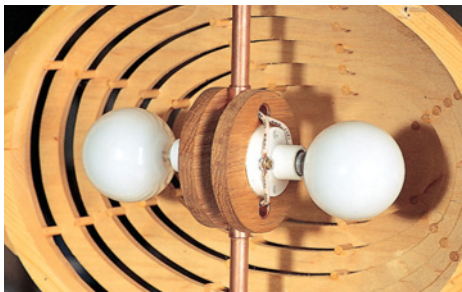

Here's what the lamp assembly looks like. Though the wiring is not difficult, I recommend you consult with an electrician friend to ensure your lamp won't accidentally transform into a "Wanda flambe."



per "tees" in the holes and glue with epoxy. Next, screw (or glue) the lamp sockets in place on the

center of the disks. Slide the upper and lower copper tubes through the holes in the backbone and

epoxy them to the copper tees in the lamp holder. Also epoxy the backbone to the tubes to keep the body from rotating. In other words, glue everything to everything. With the guidance of someone versed in the ways of flowing electrons, fish (great term here) the electric cord up through the lower copper tube and make connections at the socket terminals. Screw in the light bulbs and at-

tach the remaining body side to the backbone with brass wood screws.

Let Her Shine

Aside from a mild case of Repetitive Motion Disorder brought on by all the cutting and drilling, the pleasure derived from adding Wanda to your household will far outweigh the pain. **PW**

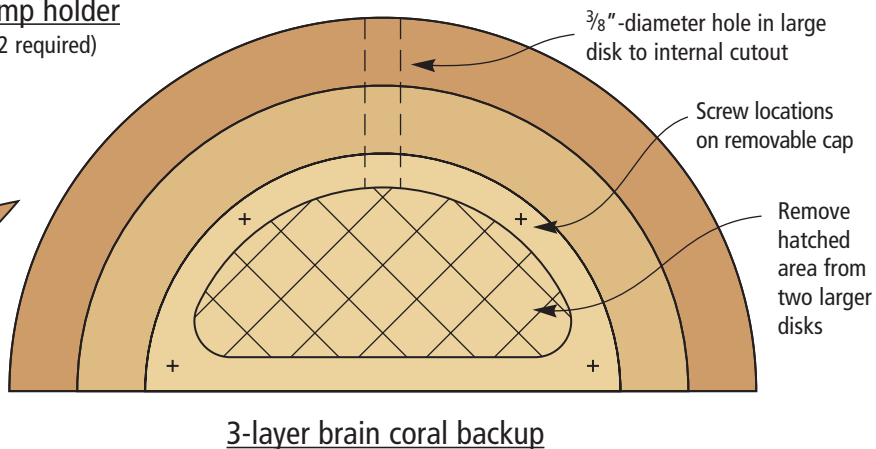
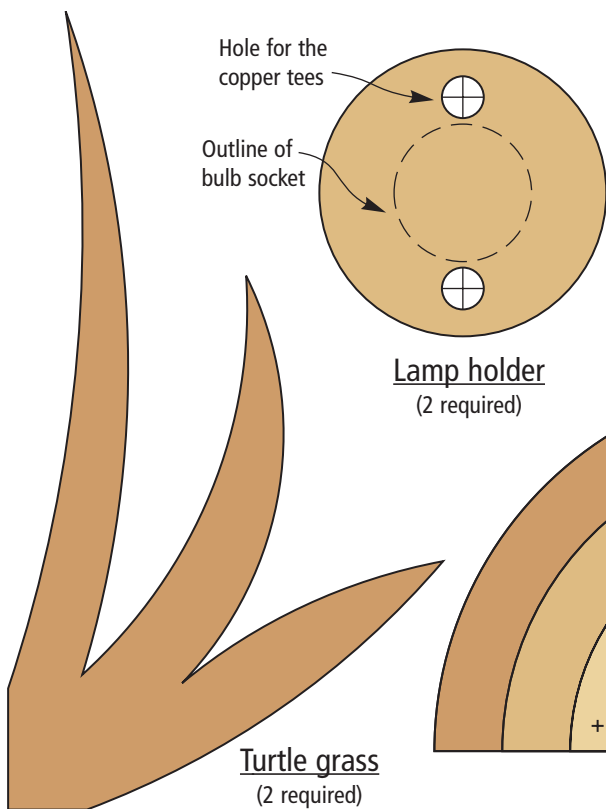

Pier Cabinet with Shelves and Storage

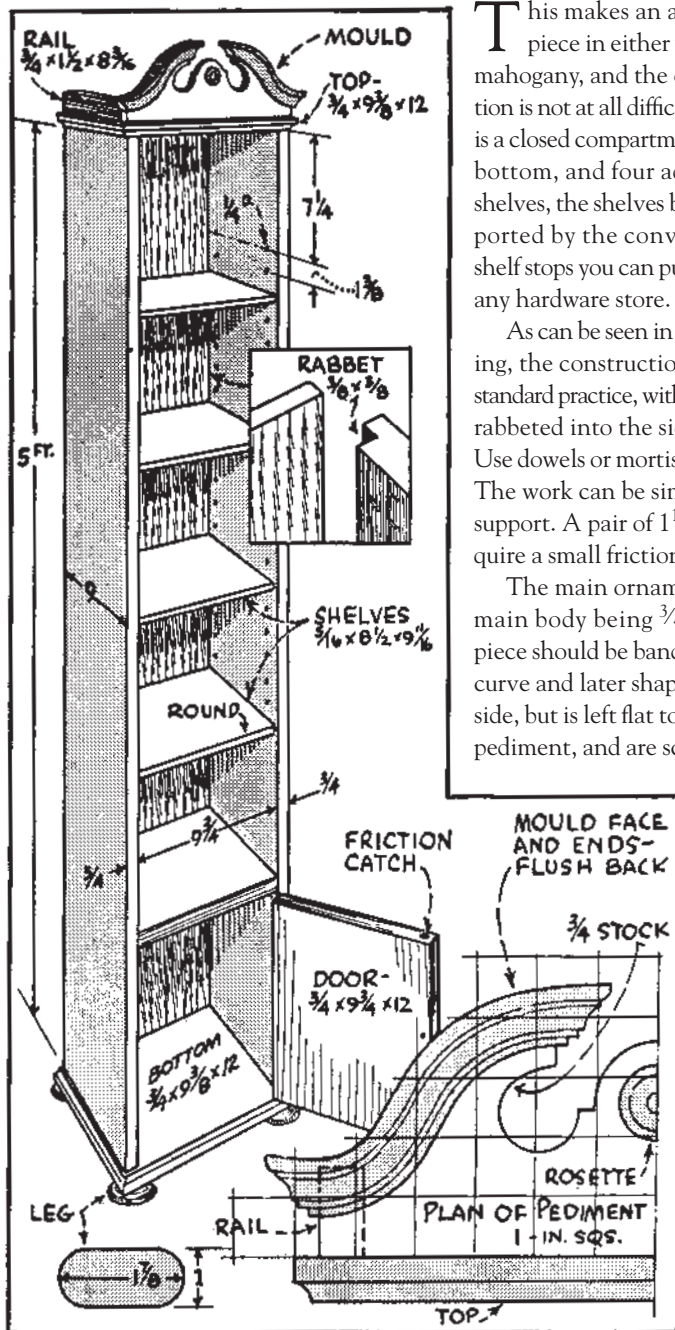

This makes an attractive piece in either walnut or mahogany, and the construction is not at all difficult. There is a closed compartment at the bottom, and four adjustable shelves, the shelves being supported by the conventional shelf stops you can purchase at any hardware store.

As can be seen in the drawing, the construction follows standard practice, with the back rabbeted into the side pieces and the top and bottom screw-fastened into place. Use dowels or mortise-and-tenon joinery when fitting the top of the compartment. The work can be simplified by using metal angles on the underside as a means of support. A pair of 1 1/2" by 1/2" brass butt hinges carry the door, which will also require a small friction catch to hold it in a closed position.

The main ornamentation is the pediment. This is made up in two parts, the main body being 3/4" stock and the moulding somewhat heavier. The lighter piece should be band sawed to shape first; then the mould can be sawn to the right curve and later shaped on the drill press. The moulding is not shaped on the back side, but is left flat to glue flush to the lower portion. The two rails butt against the pediment, and are screwed in place about 1/16" from the edge of the top.

It is important that the holes for the shelf stops be in exact alignment, and to that end it is advisable to use some form of jig when boring these on the drill press. There are 22 stop positions, the centers being 1 3/8" apart and the same distance in from the edge and back of the cabinet. The stops should be purchased before drilling the holes since the size varies from 3/16" up. There is a bit of turning to do — four legs, a rosette for the pediment and a handle for the door. All of these can be chucked quite nicely on a single screw center. PW

The Delta
From Vol. 4 January 1935

A nostalgic look back at plans published by Delta Machinery during the mid-20th century.

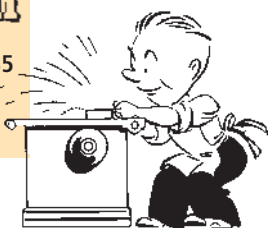

making your own CHISEL HANDLES

You don't have to own a lathe to make replacement handles that will feel like an extension of your hand.

A few months ago I had to face the unpleasant truth about my chisels. Given to me years ago by my father, my trusty old set of Marples bevel-edge chisels had run out of steel. Ground and sharpened to stubs, they had to be replaced.

A little research into the chisel market revealed a surprisingly large selection. The important consideration, it seemed to me, was performance — which blades would take the keenest edge and hold it longest. But when I'd plowed through a stack of reviews (not being a tool steel expert, I relied on the tests and experience of others) and narrowed the field, I found I'd overlooked a second important consideration: handles.

No matter how marvelous the cutting edge, if the tool feels like a billy club in your hand it's of little use. Several of the top-performing chisels had clunky handles, while the handles I liked best were attached to chisels that

didn't rate so high. Marples chisels, while not at the top of the league performance ratings, were a good value for money. But instead of the leather-washed, well proportioned ash handles of my old set, they come today with rather billy-clubbush handles of composite or ash. In the

end, I found myself buying several chisels as much for their handles as for their steel.

The more I thought about it, the more this seemed an unhappy compromise. It was once common practice to sell unhandled chisels. Craftsmen bought the chisel blade then bought or

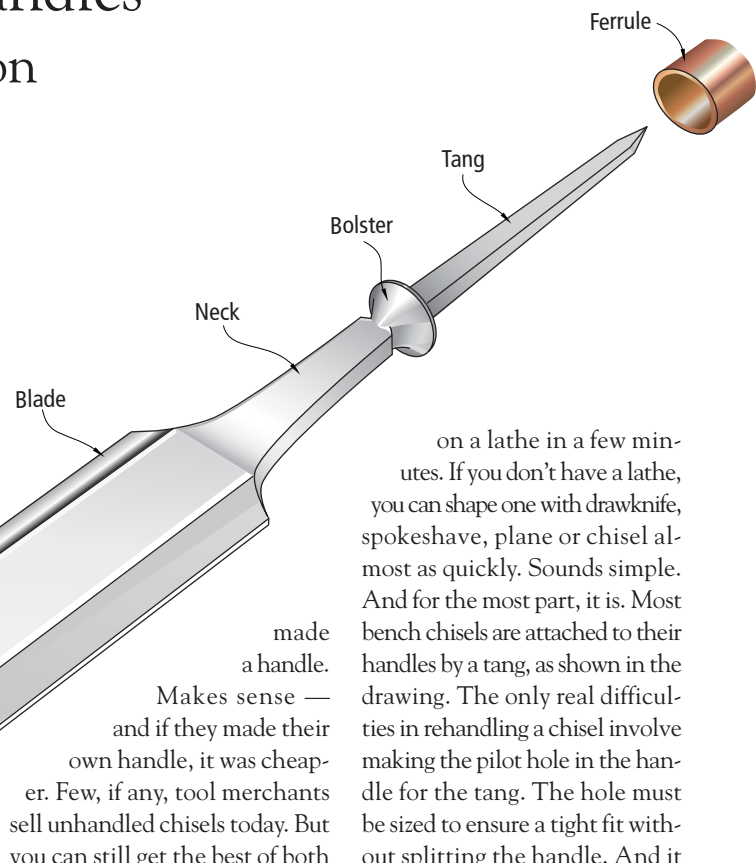

made a handle. Makes sense — and if they made their own handle, it was cheaper. Few, if any, tool merchants sell unhandled chisels today. But you can still get the best of both worlds. Ignore the handle and buy the tool for its steel or its value for money or whatever else appeals to you. Then cut off and replace the offending handle.

You can turn a chisel handle

on a lathe in a few minutes. If you don't have a lathe, you can shape one with drawknife, spokeshave, plane or chisel almost as quickly. Sounds simple. And for the most part, it is. Most bench chisels are attached to their handles by a tang, as shown in the drawing. The only real difficulties in rehandling a chisel involve making the pilot hole in the handle for the tang. The hole must be sized to ensure a tight fit without splitting the handle. And it must align the handle and the blade on the same axis. So, before you slice off the handles of your favorite chisels for replacement, rehandle a similar, but less valued, chisel (or two) for practice.

by Roger Holmes

Roger Holmes trained as a furniture maker in England and has been working wood professionally and for fun for 30 years. He lives in Lincoln, Nebraska.

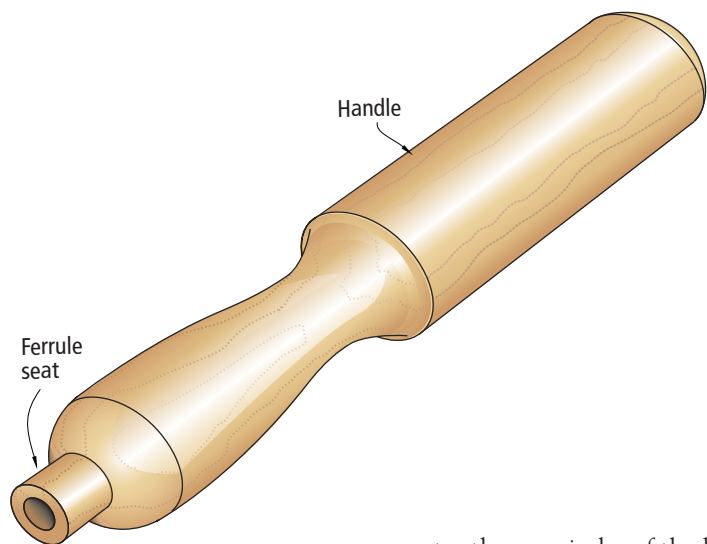

ter the remainder of the handle, which makes it easier to split.

Off with the Old

Before you can put on a new handle, you have to get rid of the old one. First, mark the estimated length of the tang on the handle — 2" or so should do — then cut off the top of the handle above that point. I cut both composite and wood handles with a hacksaw. If I've miscalculated the tang length, I won't ruin the teeth of my nice backsaw.

If you're removing a wooden handle and you want to reuse the ferrule, next make a few saw cuts just above the ferrule down to the tang. Then split away the remainder of the handle, using another chisel as a wedge. You may now be able to drive the ferrule off the tang with a hammer and cold chisel. Or you may need to bore out some of the wood from inside the ferrule to loosen it. If you don't want to keep the ferrule, just cut through its length with the hacksaw and pry it off the tang.

The process is similar for a composite handle, which is cast in place around the tang. Using the hacksaw, I cut off the end of the handle. Then I make lengthwise cuts down to the tang to quar-

Tang Types

Tangs on my old chisels are four-sided and tapered to a point. Some are irregular and bear the marks of forging. They are seated in the handle in a stepped pilot hole, as shown in the drawings on the following pages.

Tangs on some of my newer chisels are cast, not forged. Those for wooden handles are faceted on four sides, but not tapered. They seat in a single pilot hole. The corners of tapered and faceted tangs dig into the wood to make a tight, torque-resistant fit.

Tangs for my composite handled chisels are cylindrical, with small raised "fins" along their length to key them into the composite material formed around them. Driven into a wooden handle bored to the same diameter as the tang (or slightly smaller), the fins might be enough to ensure a tight fit, particularly for a light-duty chisel. I ground facets on the tang and sized the pilot hole accordingly to be on the safe side.

To ensure that the edges of the tang dig into the wood, the pilot hole should be smaller than the tang. For a square-section tapered

Saw off the top of the old handle with a hacksaw—you won't damage the saw teeth if you hit the tang by mistake.

After making saw cuts at the top of the ferrule in to the tang, split a wooden handle away from the tang.

To remove a composite handle, saw lengthwise down to the tang in three or four places, then split the remains of the handle from the tang.

Step photos by Mike Farrell; illustrations by Mary Jane Favorite.



The chisel blade in the center has a forged, four-sided tapered tang. The other blades have cast tangs. The left one, for a composite handle, is cylindrical, with small "fins" along its length. The right blade, for a wooden handle, has four faceted faces but no taper.



You can make handles in a wide variety of shapes quickly and easily on a lathe.

tang, the larger of the stepped pilot holes can be the same diameter as the diagonal across the tang as measured about one quarter the length of the tang from the bolster. (The bolster is the flared section between the chisel's narrow neck and the tang; it seats against the end of the handle.) Take the measure for the smaller hole about three-quarters of the length of the tang from the bolster. For an untapered faceted tang, make a single pilot hole of smaller diameter than the tang's diagonal measure. The difference in the size of the hole and the tang can be larger in softer woods than harder woods, which

have less give and will split more easily.

Ferrules

These short cylinders of brass or copper bind the handle just above the bolster of the chisel. The bolster and ferrule work together to prevent the handle from splitting when the chisel is driven by a mallet. Chisels and gouges used only with hand pressure need no ferrules. But most chisels have ferrules even if they're intended for fine paring work; some carving tools do not. For many chisels, the greatest risk of splitting the handle comes when fitting the handle, so a ferrule is a good

precaution regardless of the tool's intended use. Chisels and gouges subjected to heavy banging are often fitted with a metal hoop at the top of the chisel to prevent splitting at that end.

The size of the tang and bolster largely determine the size of the ferrule. If you're replacing a wooden handle, you can reuse the ferrule or use one the same size. If you want to fit a smaller ferrule or you're replacing a com-

posite handle, make sure there will be enough wood inside the ferrule to accommodate the tang. In general, the diameter of the ferrule must be at least that of the chisel's bolster.

If you don't reuse a ferrule, you can make your own from copper tubing sold at hardware stores. Or you can buy brass ferrules for a few cents apiece from Lee Valley Tools. These come in a wider range of diameters than are avail-



Grind flat facets on a round cast tang made for a composite handle to ensure a tight fit in the new wooden handle.

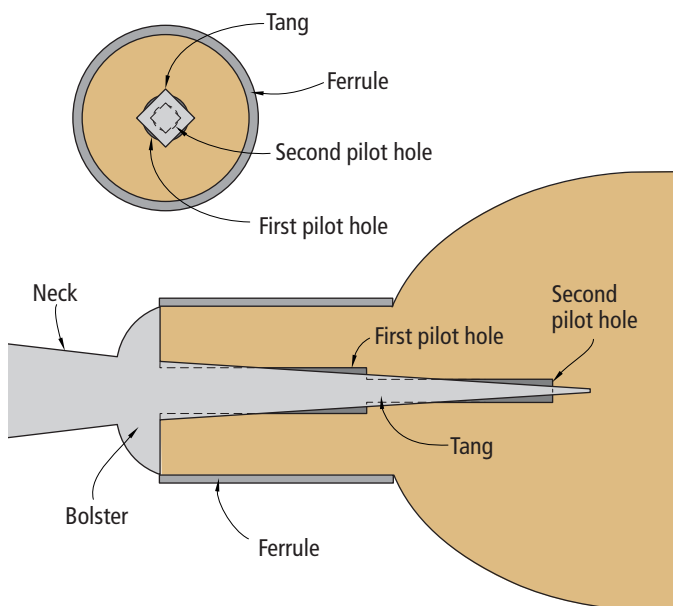



Bore the tang pilot hole on the lathe using a machinist's drill mounted in a chuck on the head stock. Feed the handle into the spinning bit with the feed wheel on the tail stock.

able in copper tube. You need to fit the handle to the ferrule, so always have the ferrule you intend to use before you make the handle. Some chisels are fitted with leather washers that slip over the tang and seat between the bolster and the end of the handle. I think they're intended somehow to cushion mallet blows, but I can't say I feel a difference in use. I like them any-

way, so I cut them out of a piece of shoemaker's sole leather and put them on.

Making the Handle

This is the fun part. You can make any kind of handle you can imagine. Turning handles on a lathe is quick and easy—you can make and discard half a dozen before you find the one you want and still be done in an hour. Shaping

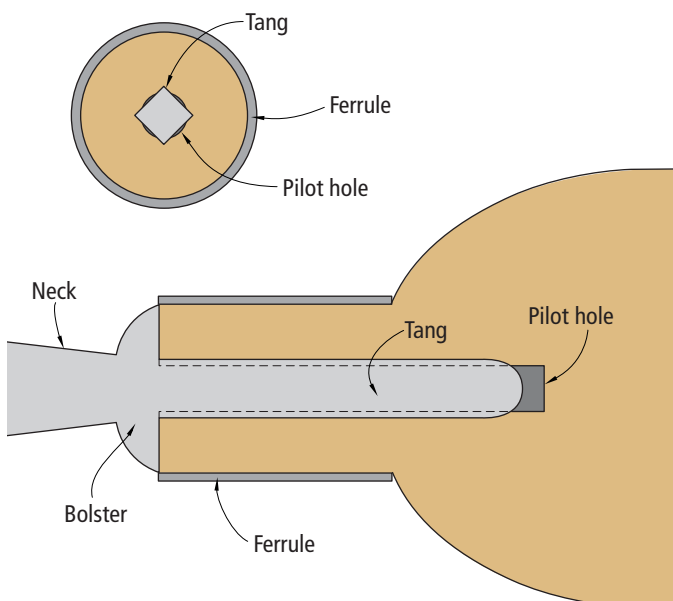

Seat the tang in the handle by repeatedly striking the end of the handle against an iron plate or machine table.

handles with drawknife, spokeshave, plane or chisels takes longer, but can produce handle shapes — faceted or flattened for example — that are unobtainable on a lathe. And you can combine turning and hand-shaping. If you want to rehandle a chisel but don't want to make the handle, you can buy a classic boxwood pattern in several sizes from Lee Valley.

Commercial handles are commonly made of ash, beech or boxwood. But any reasonably hard wood will do. I'm looking forward to making some handles of osage orange, a native here in Nebraska that has tight grain, a lovely orange color, and is tough as nails. Firewood suppliers are excellent sources of ash, maple, birch and other local woods that make fine handles. If you can split handle blanks from the log, you'll ensure that the grain will run parallel to the handle's length, the strongest orientation.

On the Lathe

Turning is the easiest way to make

SUPPLIES

Lee Valley Tools
800-871-8158
www.leevalley.com

Octagonal Boxwood Chisel Handles available in 5¼" lengths to 6¼" lengths. Priced from \$6.95 to \$8.25 each.

Brass Ferrules available with interior dimensions from .312" to 1½". Prices range from 15 cents to 96 cents each.

a handle. Whatever shape you choose, it is important to fit the ferrule snugly to one end. It needn't be a forced fit, but it shouldn't rattle around on the wood, either.

The great advantage of a lathe is in boring the pilot hole for the tang. I mount a chuck and bit on the head stock and feed the handle onto the bit by turning the tailstock's dead-center wheel. This bores a hole right on the handle's axis, ensuring that the chisel blade and handle will be properly aligned.

Use machinist's bits — the tapered nose makes a neater, easier entry than a brad point or other spur bit. Complete the handle's shape (and rub finish on the spinning handle with a cloth if you wish) before you bore the hole.

Assembly

To join chisel and handle, slip the ferrule in place on the end of the chisel handle, add a leather washer if you want one and start the tang in the pilot hole. You can fix the chisel in a vise and drive the handle on. I prefer to upend the chisel and handle and bang the end of the handle on a machine table or other heavy piece of iron. Done this way, the blade's own weight drives the tang into the handle and I don't have to worry about the blade slipping



Best Round Birch Chisel Handle.



Common Round Birch Chisel Handle.



Best Improved Round Birch Chisel Handle, London pattern.



Best Taper Round Birch Chisel Handle.



Best Curving Pattern Birch Chisel Handle.

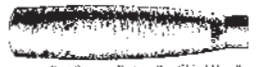

Best Curving Pattern Box Chisel Handle.

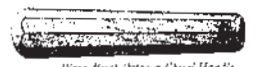

Plain Birch Octagon Chisel Handle.



Strass H. Shed Plain Octagon Birch Chisel Handle.



Best London Shingon Birch Chisel Handle.



Common Birch, or Birch Chisel Handle.



Best Taper Octagon Box Chisel Handle.



Birch Socket Chisel Handle, not Acorned.



Bright Iron Hooped Ash Socket Chisel Handle.



Iron Hooped Ash Socket Shod Chisel Handle.



Dark Wood Ash Socket Chisel Handle.



Bright Double Iron Hooped Ash Reversed Chisel Handle.



Birch Turning Chisel Handle

Different chisel handles as shown in R.A. Salaman's "Dictionary of Woodworking Tools" (Astragal Press), an excellent resource on the identification and history of hand tools.



in the vise. It takes a while, but unless you've badly underestimated the size of the pilot hole, the bolster will eventually seat snugly against the end of the handle. Even if the hole is a bit too tight, splits are usually contained by the ferrule.

Hand-shaping a Handle

If you don't have a lathe, or you want a faceted handle, it is easy to shape one by hand. The tricky part is boring the pilot hole in the handle so that the blade and handle will be aligned. A blade that skews off the handle centerline can be very awkward to use. I think the easiest method is to bore the hole in a square handle blank before shaping the handle. With a drill press the hole can be bored very accurately. Or the blank can be held firmly in a vise for hand drilling. Set a square or two up to gauge the angles.

Next, form the seat for the ferrule. Make saw cuts in at each corner to prevent splitting beyond the ferrule seat. Then pare carefully with a chisel until the ferrule fits the seat snugly. If you're confident that the pilot hole is well centered along the length of the blank, you can shape the handle, then assemble it with ferrule and blade as described previously. If you're uncertain



After making cuts at the corner to prevent splitting along the handle's entire length, form the ferrule seat with a chisel (left).

If you're uncertain about the alignment of the tang pilot hole and handle, you can assemble the blade to the handle blank. Draw lines on the handle along the axes of the blade. Shape the handle parallel to the axes to ensure good blade-handle alignment.



about the orientation of the pilot hole, you can assemble the handle and blade, then shape with drawknife and spokeshaves, as shown in the photos. This can be a bit awkward in spots, but it allows you to make adjustments in the handle to offset an off-

center pilot hole.

Rehandling a chisel or gouge is very satisfying. A homemade handle may not be stronger or more durable than one from the factory. But it is certainly more personal and is worth doing for that reason alone. **PW**



Photo by Al Parrish.

There are few clamping jobs that are more difficult than trying to secure something big so that you can work on its edge. Mortising a large door for a hinge is a common situation. Cleaning up the long edge of a board you just band sawed is another.

These problems are quickly and easily solved with \$10 and by taking a lesson from 18th-century joiners. A common feature on older benches is what's called a sliding deadman. This contraption works with your face vise to support work that is long, wide or both long and wide. I adapted mine from a sketch of a deadman

Bench Deadman

For less than \$10, you can rig your workbench to easily support and clamp large panels, doors and long boards.

by Christopher Schwarz

Comments or questions? Contact Chris at 513-531-2690 ext. 407 or chris.schwarz@FWPubs.com.

BENCH DEADMAN

NO.	ITEM	DIMENSIONS (INCHES)			MATERIAL	NOTES
		T	W	L		
2	Rails	1 ³ / ₈	1 ¹ / ₂	47	SYP	
1	Deadman	1 ³ / ₈	7	19 ⁵ / ₈	SYP	1/2" TBE
1	Ledge	1 ³ / ₈	4 ⁷ / ₈	7 ¹ / ₂	SYP	
1	Dowel	5/8 dia.		5		

TBE = TENON ON BOTH ENDS; SYP= SOUTHERN YELLOW PINE OR EQUIVALENT

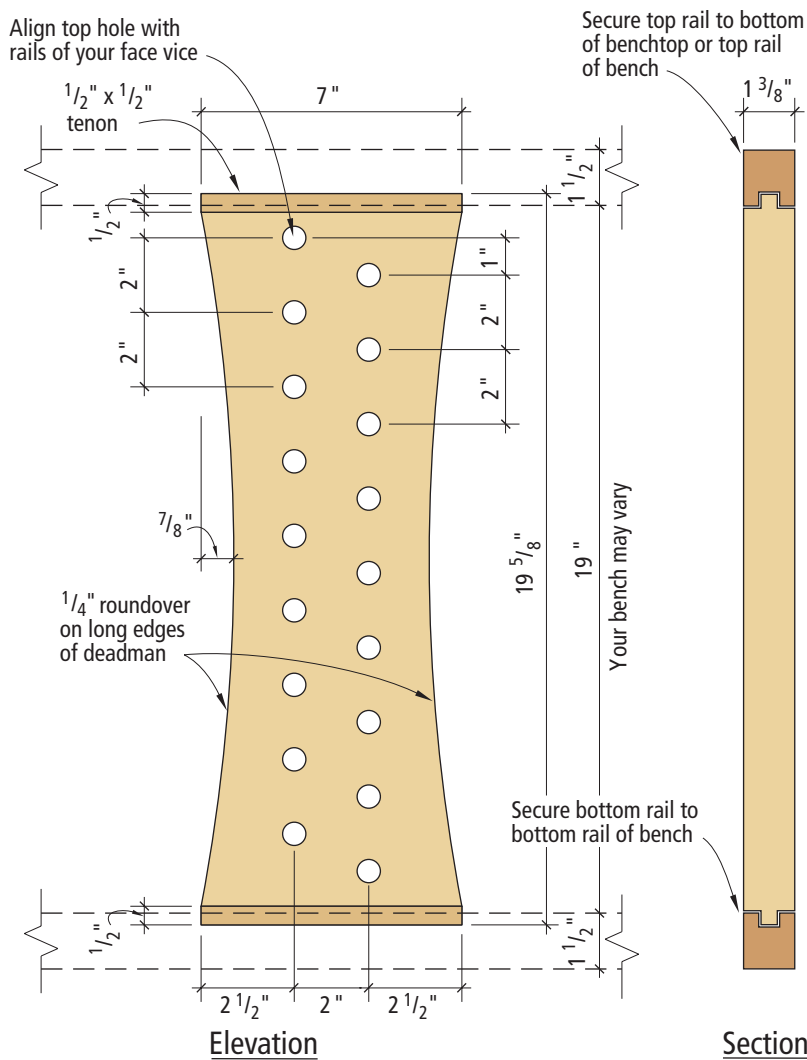

Half-size plan of ledge

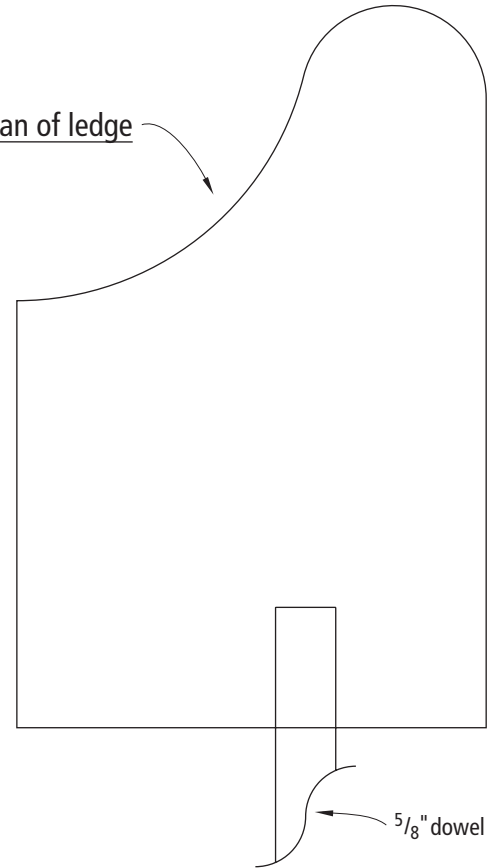

diameter holes through the part for the ledge. I bored two staggered rows of holes; each hole is 2" down from the one above it. The topmost hole is located so that when the ledge is in place in the deadman, it lines up with the rails on my face vise.

Cut the 1/2"-long x 1/2"-thick tenons on both ends of the deadman. The tenons are slightly thinner than the width of the grooves they ride in. Now cut the deadman to shape. The long edges are curved in 7/8" so they are easy to grasp when the deadman is resting against your bench's legs. Round over the long edges of the deadman to make it friendly to grasp. I used a 1/4" roundover bit

by Graham Blackburn that was featured in his excellent book "Traditional Woodworking Handtools" (The Lyons Press). This particular version is sized to fit our "\$175 Workbench" from the February 2001 issue, though

you can easily cut the rails and the sliding deadman to fit your bench.

After you determine the proper dimensions for all your parts, begin by cutting your pieces to rough size. Cut a 3/8"-deep x 9/16"-

wide groove in the center of a long edge of each rail. Use a dado stack in your table saw, a straight bit in your router or a plough plane to cut the groove.

Before you cut the curves on the deadman itself, bore the 5/8"-

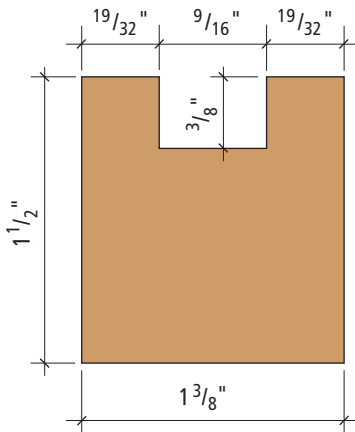

Full-size section of rails

in a router.

Trim your rails to the proper length and install them. Screw one rail to the bottom rail of your bench using four #8 x 2" screws. Don't use glue; you want to be able to remove the rail for later adjustments or repairs. Now put the top rail and deadman in place and line them up with the bottom rail. Using screws, secure the top rail to the underside of your bench's top, or to the top rail of your bench — if you have one. Wax the grooves in the rails. The deadman should slide back and forth with minimal effort.

Now make the ledge. You could simply use a dowel. I chose to make one a little fancier. Bore a 1 1/4"-deep hole in one end for the 5/8" dowel and glue it in place, again making sure that when the ledge is inserted into the top hole, it lines up with the rails on your face vise. You might need to sand your dowel to fit the holes in the deadman. I used a 1/4" beading bit in a router to shape three edges of each side of the ledge. Finish your deadman to match your bench. **PW**



Submit your caption(s) for this issue's cartoon on a postcard to *Popular Woodworking*, Cartoon Caption #52, 1507 Dana Ave., Cincinnati, OH 45207 by **February 14**. Winners will be chosen by the editorial staff.

The winner will receive the new Freud FJ85 Jigsaw with Electronic Cruise Control. This variable speed, 6-amp, orbital jigsaw offers toolless blade change and the cruise control keeps the blade speed constant under different loads to provide a finer, faster cut. The runners-up each win a one-year subscription to *Popular Woodworking*.



freud[®]



"Now that's what I call 'pressure-treated wood!'"

Brett Britton, of Crossville, Alabama, is the winner of our Cartoon Contest from the August issue and recipient of a fine set of Freud router bits. The following runners-up each receive a one-year subscription to *Popular Woodworking*:

"I can actually see the syrup coming out of your maple bookcase."

Ryan Vogt, Ulrich, Missouri

"Any more clamping pressure and we'll be making diamonds!"

Larry Cramer, Brookings, South Dakota

"Hey Butch what's under those clamps? Is it alive?"

Michael Collingsworth, Centerville, Ohio

ALARMS

WIRELESS DRIVEWAY ALARMS



Lets you know anytime anyone walks or drives into your place.

DAKOTA ALERT, INC.
BOX 130, ELK POINT, SD 57025
605-356-2772
www.dakotaalert.com

Reader Service #138

BAND SAW BLADES

Band Saw Blades
Swedish Silicon Steel
TIMBER WOLF™
1/8" Through 2"
call: Suffolk Machinery
800-234-7297 Free Catalog
www.suffolkmachinery.com

Reader Service #139

BUILDINGS

Save BIG On Quality Steel Buildings
Factory Direct!
Bigger Garage? Build It Yourself!
AUTO & RV GARAGES • WORKSHOPS
TOOL & EQUIPMENT STORAGE
Made in the U.S.A.
U.S. Buildings
www.us-buildings.com
1-800-463-6062
FREE BROCHURE & FACTORY PRICE LIST

Reader Service #140

40' x 50' x 12'
\$5,795
Build It Yourself And Save!!! 10,000 Sizes, Bolt-Together All Steel Buildings & Homes. Call Today For A Price Quote And Brochure.
HERITAGE BUILDING SYSTEMS®
800.643.5555
heritagebuildings.com

BUSINESS OPPORTUNITIES

Bunk Beds
Clear \$300/day building wood bunk beds at home. Start out in spare time & expand the business at your own pace. Earn \$185 on a \$269 sale, \$411 on a \$611 sale. Call 800-382-3180 Ext 1579. Bunks, Dept. 1579, Box 2000, Avon, MN 56310

Reader Service #141

Clear Up To \$2,000 per Weekend With COUNTRY CRAFTS

Build small wood furniture at home. Start out in your spare time & expand business at your own pace.
Example: Deacons Bench
Selling Price \$39.95 Material Cost \$8.00
Time required to make: 30 Minutes
Send \$3.00 for your Info Pak (refunded on your 1st order)
Country Crafts @ PO Box 2000, Dept 3024 Avon, MN 56310-2000

Reader Service #142

PLANS & KITS

BARGAIN BOOKS FOR WOODCRAFTERS
Over 500 books on woodworking and other hobbies, most \$2.95 to \$6.00! Build birdhouses, whirligigs, furniture, more.
FREE CRAFTS CATALOG - write to Dover Publications, Dept. PW0201 31 E. 2nd St., Mineola, NY 11501.

Reader Service #145

U-BILD.COM

On-line catalog pictures hundreds of full-size woodworking plans at low prices. Free downloadable mini-plans. All skill levels. Free shipping. 64-page color catalog \$3.95 (refunded on 1st order) call (800) 828-2453.

Reader Service #146

www.WoodcraftPlans.com

- Over 800 full-size project plans -
Call for our 104 page catalog or visit our website today and see!

1.800.296.6256

Reader Service #147

ROUTER BITS

www.routerbits.com

Whiteside Router Bits
Systematic Saw Blades
Fisch Forstner Bits
HTC Mobile Bases



Router Bits on the Web

Reader Service #148

SAWMILLS

A ONE MAN PORTABLE SAWMILL that you can afford.
CALL: (573) 663-3133
The Baker Model 18M Band Sawmill.
Cuts a 30" dia. log! Up to 24-HP gasoline engine!
Canadian number: (705) 835-3222
www.baker-online.com

Reader Service #149

STOP BUYING LUMBER!

Mill your own... with Granberg's Alaskan Saw Mill!



Prices start at **\$135!**

(G777 Small Log Mill)

Use our attachment and your chain saw to make beautiful lumber out of any log! Call toll free or go online for FREE information! 866-233-6499 www.granberg.com

Reader Service #150

WOOD EPOXIES

Quikwood® Epoxy Putty Stick
Repair Rebuild Restore Patch & Bond Wood
The Woodworker's Dream - When Fillers or Glue Won't Do!
Easy to use; tear off, hand-mix and apply
Shapes like modeling clay, hardens like wood
Sand, carve, drill, tint, paint, and finish
www.polymer systems.com/quikwood.htm
888 4 fix wood ext. 2209

Reader Service #151

WOOD SUPPLIES

UNFINISHED WOOD
Thousands of Wood Parts, Turnings & Hardware
WHOLESALE PRICING!!
CUPBOARD 119 Miami St; PO Box 148P
DISTRIBUTING Urbana, Oh 43078
www.cdwood.com

Reader Service #152

WOODTURNING SUPPLIES

Get a Free Copy of our CATALOG for WOODTURNERS
Call Toll Free... 1-800-683-8876
or write...
Packard Woodworks PO Box 718 Tryon, NC 28782
website: www.packardwoodworks.com

Reader Service #144

ADVERTISE IN Popular Woodworking

For information about classified advertising call:

Joan Wright,
800/388-1820

Ad close for the May/June issue is February 27, 2002.

BOOKS & CATALOGS

FREE CATALOG of books to enhance your wood-working skills, projects, and your home. Also receive \$5.00 off your first order from this catalog. Call toll free 1-800-289-0963, or write to Popular Woodworking Books Catalog, 1507 Dana Avenue, Cincinnati, Ohio 45207.

BUSINESS OPPORTUNITIES

EASY WORK! EXCELLENT PAY! Assemble Products At Home. Call Toll Free 1-800-467-5566 Ext.3445.

\$100.00 PER HOUR, woodworking from your garage, full or part-time. No selling! Free brochure: Home Tech 800-456-4987.

EARN \$105/HOUR Repairing Loose/Broken Wooden Chairs! Full/Part Time 1-877-427-7580 Dept. 902. www.thechairdoctor.com.

GET PAID \$258.20 a roll taking easy snapshots! Film supplied. Photowealth, Box 3706-WW, Idyllwild, CA 92549; 909-659-9757.

\$400 WEEKLY ASSEMBLING PRODUCTS from home. Rush SASE: Home Assembly - PW, PO Box 216, New Britain, CT 06050-0216

FINISHES

SPRAY-ON SUEDE. Line boxes easily. Free brochure with sample. DonJer, 13142 Murphy Road, Winnebago, IL 61088; 800-336-6537; www.donjer.com

HARDWARE

HARDWARE FOR CABINETS, closets, furniture etc. Free catalogs: www.bainbridgemfg.com; www.hannahshandles.com; call 800-255-4702.

MISCELLANEOUS

POST OFFICE BOX DOOR FRONTS, #1 \$8.00; #2 \$9.00; #3 \$10.00 + S&H. Coin slot plates, etc to make banks. SASE for info. Hubbert, PO Box 1415, Fletcher, NC 28732; 828-687-0350.

PLANS & KITS

HOME-N-PATIO™ FURNITURE PLANS Professionally designed, easy to follow. Accurate. www.precision-images.com.

QUALITY WOODWORKING PLANS and patterns since 1977. Adirondack, swings, toys, bird houses, and more! www.plan-craft.com.

BYO™ (BUILD YOUR OWN) FURNITURE KITS.

Simple, beautiful, strong. 415-454-9948; www.tamalpais.com.

THICKNESS DRUM SANDER PLANS.

Also, 3 pole quilt frame plans \$9.50 each. See http://www.moritzdesigns.com.

PLANS FOR RE-SAWING. Bandsaw cuts 12" thick. \$15.00. Doverton, 2742 Hickman Road, Des Moines, IA 50310.

CARLYLE LYNCH MEASURED DRAWINGS -

Museum and private collection furniture plans by Carlyle Lynch. Catalog \$2. PO Box 13007, Arlington, TX 76094; 817-861-1619.

WOOD SUPPLIES

EASY ORDERING! ONLINE CATALOGUES: hardware, KD & other fasteners, sanding discs, belts, lots more. Profhdwr.com & sandingproducts.com

Increase Workshop Efficiency!

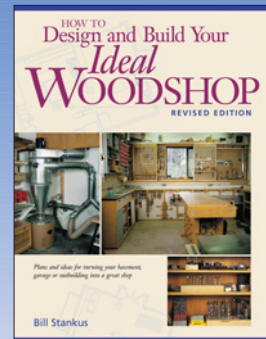

This newly-revised detailed instruction book by Bill Stankus pools the knowledge and expert advice of hundreds of woodworkers into one step-by-step guidebook to help you create the safest and most efficient workshop possible.

More than 100 color photographs and a wide range of floor plans will help you choose the arrangement that best fits your workshop — whether it's in a closet, basement or garage. And detailed instructions with a focus on safety take the guesswork out of planning your perfect shop.

Order your copy of *How to Design and Build Your Ideal Woodshop* today!
#70522-K/\$27.99/128p/ pb/275 color images

Available at your favorite bookseller or directly from the publisher using the Order Form below.

ORDER FORM

YES! Please send me _____ copy(ies) of *How to Design and Build Your Ideal Woodshop* (#70522-K) \$27.99 each

SUBTOTAL: \$ _____

In the U.S. please add \$3.95 shipping and handling for the first book, \$1.95 for each additional book. In Ohio and New York, please add applicable state tax. In Canada, add US\$5.00 shipping and handling for the first book, US\$3.00 for each additional book, and 7% GST. Payment in U.S. funds must accompany order.

TOTAL: \$ _____

Check or money order enclosed -or-
 Charge my VISA MC AmEx
 Acct.# _____
 Expiration date _____
 Signature _____
 Name _____
 Address _____
 City _____
 State/Prov. _____ ZIP/PC _____

Send to:  Popular Woodworking Books
PO Box 9274
Central Islip, NY 11722-9274

ZAL01PW

For more information or to order by Credit Card visit
www.popularwoodworking.com/store/books
 or call toll free 1-800-221-5831

CLASSIFIED ADVERTISING ORDER

Send to: **Popular Woodworking®**
 Attn: Joan Wright
 1507 Dana Avenue
 Cincinnati, Ohio 45207
 Phone: (800) 388-1820
 Fax: (513) 531-1843

(PLEASE PRINT OR TYPE)

Your Name _____
 Company (name in ad) _____
 Address _____
 City _____
 State _____
 Zip _____
 Phone _____
 Fax _____
 Payment: Check enclosed
 Bill my Visa/MasterCard
 Card _____
 Number _____
 Exp. date _____
 Signature _____

CLASSIFIED DISPLAY

1X 3X 6X

1-inch @ \$260 \$230 \$210
 2-inch @ \$520 \$460 \$420

• Discounts for consecutive advertising.

READING NOTICES:

15 word minimum. • Save 15% with 3 issues.

15 Words (minimum).....\$63.00

Each additional word
 @\$4.20.....\$ _____

Total for 1 ad.....\$ _____

15% Discount with 3 Consecutive Issues:

Total of one ad.....\$ _____

Minus 15% (or x .85).....\$ _____

Total for 3 ads.....\$ _____

AD COPY:

(Please print. Use separate sheet of paper for additional words)

Caring for Furniture

Do furniture care products really ‘moisturize’ your project or its finish? Learn the truth about furniture cleaners and polishes.

Furniture care is a subject you’re probably not very interested in, but it’s a pretty sure bet that the people you give or sell your projects to find it very interesting. In fact, “How do I care for it?” is probably the first question they ask you.

If you give them an intelligent answer, their respect for you grows, but if you fumble around and show you don’t really understand the subject, they may lose some confidence in you. There’s no reason for this to happen because there are really only two things you need to know: the causes of damage and how to avoid them, and which furniture polish to recommend.

Causes of Damage

The two elements that cause the most damage to furniture, especially to the finish, are light and physical abuse. No one can keep furniture totally away from light, but furniture can be kept away from bright light near windows, which causes finishes to deteriorate faster than they would otherwise. To see what light does to finishes, compare the condition of an old finish protected from light under some hardware with the finish around it. (See the photo on the next page.)

So the first instruction you should give is, “If you want the finish to stay in good shape for as long as possible, keep the furniture away from bright light, especially direct sunlight.”

The second is, “Discipline your children and pets so they don’t abuse the furniture, and use table cloths, place mats and coasters to protect the finish from scratches and water rings.”

Furniture-care Products

There’s more hype, myth and misinformation about furniture polishes and waxes than about any other product related to furniture. Most of the problem is created by the suppliers themselves.

Here are the facts.



Don’t go looking for these furniture-care products on your next trip overseas. For the most part, the United States is the only country that uses them. Why? Usually water cleans just as well.

Furniture-care products do five things more or less well:

- add shine to a dull surface.
- add scratch resistance.
- aid in dusting.
- aid in cleaning.
- add a pleasant scent to a room.

No furniture polish or wax replaces natural oil in the wood (only a few exotic woods ever had it in the first place), feeds or moisturizes the wood, feeds or moisturizes the finish or builds up (unless, of course, the excess

isn’t wiped off). No furniture polish or wax does any harm to the wood or finish, either. Furniture polishes and waxes are totally inert.

In fact, furniture-care products don’t really do much at all, and the United States and, to a lesser extent, Canada, are the only countries where these products are used to any great extent. Most people in Europe and Japan just wipe their furniture with a damp cloth when it gets dusty or dirty.

So you could simply advise your family member, friend or customer, “You don’t need

to do anything at all except keep the furniture clean by wiping it now and then with a damp cloth.” But this probably won’t work because people are conditioned to want to “use” something, to do something “good” for their furniture.

So, to understand the differences in the furniture-care products they could use, let’s look at the ingredients in them and see what each does.

Besides the added scent, which does nothing for the furniture but rewards people for their dusting effort by making their house smell nice, furniture-care products are composed of one or more of four basic ingredients: slow evaporating petroleum-distillate solvent, water, wax and silicone oil.

- Petroleum-distillate solvents used in furniture polishes are essentially slow-evaporating paint thinner. This liquid adds shine and scratch resistance only until it evaporates (usually within a few hours), helps pick up dust and cleans grease and wax. It has no cleaning effect on water-soluble dirt like sticky fingerprints or soft drink spills.

Most clear polishes on the market, those commonly sold as lemon or some other nice-smelling oil and packaged in clear plastic containers, are composed of this single ingredient.

- Water evaporates too rapidly to be effective at adding shine or scratch resistance, but it helps pick up dust, and it’s a great cleaner for most types of dirt. In many liquid and so-called “cream” furniture polishes, and in some liquid and paste waxes, water is added

to improve cleaning ability. You can recognize these products by their milky-white color (they are emulsifications like milk is an emulsification of water and animal fat). Most are packaged in aerosol-spray containers.

- Wax is a solid substance at room temperature and is by far the most effective of the four ingredients at adding shine and scratch protection over a long period of time because it doesn’t evaporate. But

wax is hard to apply (because of the effort necessary to wipe off the excess) and there’s no reason to apply it very often, so it’s not effective for dusting, cleaning or adding scent.

Sometimes wax is added to liquid polishes, and you can identify these by the settling that occurs over time – polishes containing wax have to be shaken before use. Clearly, these polishes will be more effective at adding long-lasting shine and scratch protection than polishes that don’t contain wax, but more effort will be required to remove the excess from the surface.

- Silicone oil is a synthetic oil similar to mineral oil in the sense that it is totally inert and doesn’t evaporate, but silicone oil is slipperier and bends light better than mineral oil. The first quality makes furniture polishes that contain this oil extremely effective at reducing scratches and the second makes finished wood appear richer and deeper.

Most aerosol-spray polishes contain silicone oil, though rarely is this admitted. Silicone oil has been given a bad reputation by furniture refinishers and museum conservators due to

Light is a prime cause of finish deterioration. Here you can see that the finish protected under the hardware is in near-perfect condition, while the finish exposed to light for many decades is badly crazed.

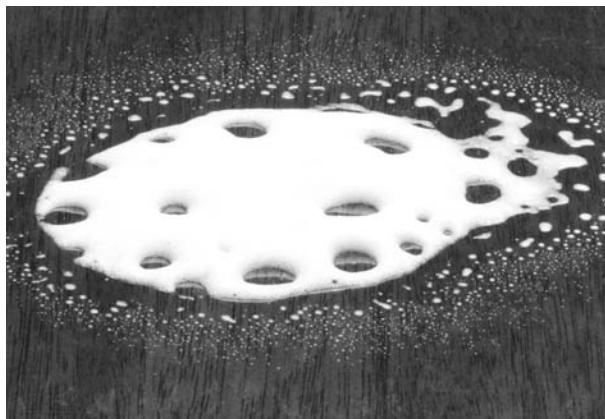

The furniture polishes that clean best are emulsifications of water and petroleum-distillate solvent. These polishes are usually packaged in aerosol spray cans and are always milky-white in color.

the added difficulty they have refinishing furniture treated with this oil. But consumers love silicone-oil polishes because they keep furniture looking good between polishings better than anything except wax, and they’re easy to use.

Most polishes that contain silicone oil also contain petroleum distillates and water, so they’re good cleaners.

How to Choose

So how do you make sense of this for the recipients of your projects? Easy.

If they just want something for dusting, choose any liquid furniture polish.

If they want something that will clean in addition to picking up dust, choose any milky-white furniture polish – virtually all polishes in aerosol containers except Scott’s Liquid Gold.

If they want maximum scratch resistance and richer depth without the work involved with using paste wax, choose a polish that contains silicone oil – virtually all polishes in aerosol-spray containers except Endust and Scott’s Liquid Gold.

If they want to add shine and protect an old, deteriorated surface from abrasive damage, choose paste wax – because the other possibilities either evaporate too quickly (petroleum distillate) or highlight the cracks in the finish (silicone oil). Dusting and cleaning will have to be done separately with a damp cloth. **PW**

Bob Flexner is author of “Understanding Wood Finishing” and a contributing editor to Popular Woodworking.

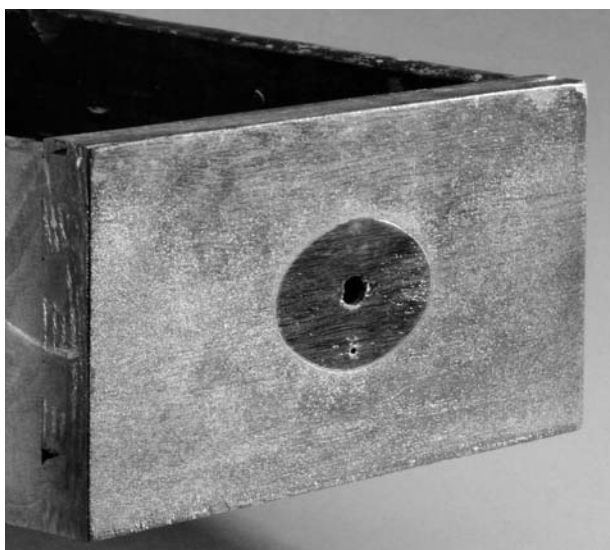

Sacrificial Scraps

On a cold winter night I realize memories are made of many things, including cut-offs from my shop's scrap barrel.

I have a small, galvanized trash can in my workshop where I throw scraps of hardwood that are too small to put to use. It sits near the outfeed side of my table saw where it's out of the way but easily reached by a short toss from anywhere in the shop. Pieces of white oak, maple, cherry, mahogany, black walnut, rosewood and the occasional poplar fragment eventually overflow the 3'-wide can and have to be dealt with. Pine doesn't make the cut (if you'll pardon the pun) because the can is for wood that will end up in the family fireplace. Pine burns too hot and coats the flue with creosote, so it goes in the compost heap along with my sawdust. But the hardwood scraps pile up and once each year they warm the cold New England winter; usually in late January or early February, and for some reason that I can't explain, always at night.

The fire starts out with nondescript strips of plywood for kindling. They're light and burn quickly. On top of that go thin lengths of any wood that is unfit to use. Perhaps some strips of maple with ugly wane or lengths of glued-up end grain cut from squaring-up a tabletop. Thicker but shorter pieces follow. Lengths of picture frame that are just too small to eke out four more sides, or maybe some sections of trim from a large case piece. The fire slowly builds and, with the help of a few logs, warms the house for hours.

But it's the process of feeding the blaze that proves cathartic. Because the barrel fills over the course of a year or more, pieces from past projects emerge and remind me of the different phases of my long apprenticeship with woodworking. Short cut-offs of practiced hand-cut dovetails look rougher as they emerge from deeper within the barrel. Pieces that were used for testing machine setup tell of trial and error to get the perfect fit. Some

lengths of wood have so many holes, mortises, rabbets, grooves and tenons that there is simply no surface left to cut. I can't help but feel a pang of regret when throwing these hardworking helpers onto the fire. It seems a shame to burn them, but they served their purpose and their time has come.

I give away most of what I build, so some scraps take me back to projects that I haven't seen in a while. I might pick out a piece and show it to my wife. We'll discuss whatever it was that I was building then, or something that happened in our lives at that time. It's like getting a roll of film developed that has been in the camera for a year.

There are pieces, though, that I have no compunction about burning. If a project was ill conceived or poorly executed, I get a sense of finally being done with it once the last scraps meet their fiery demise. It's not as if I burned the whole piece, but I might have wanted to during construction. Throwing the cutoffs into a roaring blaze is the next-

best thing.

And finally, at the bottom of the barrel, I find pieces from what seems like long ago. Some of the scraps reveal the progress that I've made in the months since they were tossed out. Or a scrap might surprise me in that I don't remember being able to perform a particular operation so long ago.

When there's nothing left except sawdust and slivers, the barrel goes back to its humble position by the saw, ready to accept a new lot of castoffs and scraps. Sitting there empty, it seems to invite me to get busy and do some woodworking. Maybe this will be the year that I master hand-cut dovetails. Or perhaps I'll tackle a particular project that may have intimidated me in the past. It's funny, but that empty barrel seems to hold a lot of promise. **PW**



Joe Pescatello works wood in Rye, New Hampshire. His articles have appeared previously in Modern Drummer and Home Office Computing magazines.

Makita

2-1/4 H.P.

INDUSTRIAL ROUTER KIT

KIT INCLUDES FIXED BASE ROUTER, PLUNGE BASE & ACCESSORIES

Powerful 2-1/4 H.P. (11 AMP) Makita Made Motor

Makita Sub-Base Accepts Industry Standard Template Guides

Accessories Included: 1/2" and 1/4" Collets, Dust Nozzle Assembly, Straight Guide, Clear Sub-Base, Wrenches and Plastic Tool Case



Model RF1101KIT

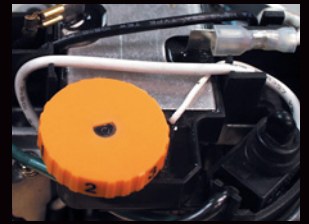

Electronic speed control with soft start provides smooth start-ups and maintains constant speed under load



Variable speed control dial (8,000 - 24,000 RPM) to match the speed to the application



Cam-lock lever for fast, easy and secure depth adjustment



Conveniently located plunge lock lever for efficient operation



For more info, call 1-800-4MAKITA or visit www.makitatools.com

EVERYTHING YOU NEED

PWA-1101-F MA-0855-01.M19

Circle #128 on Reader Service Reply Card

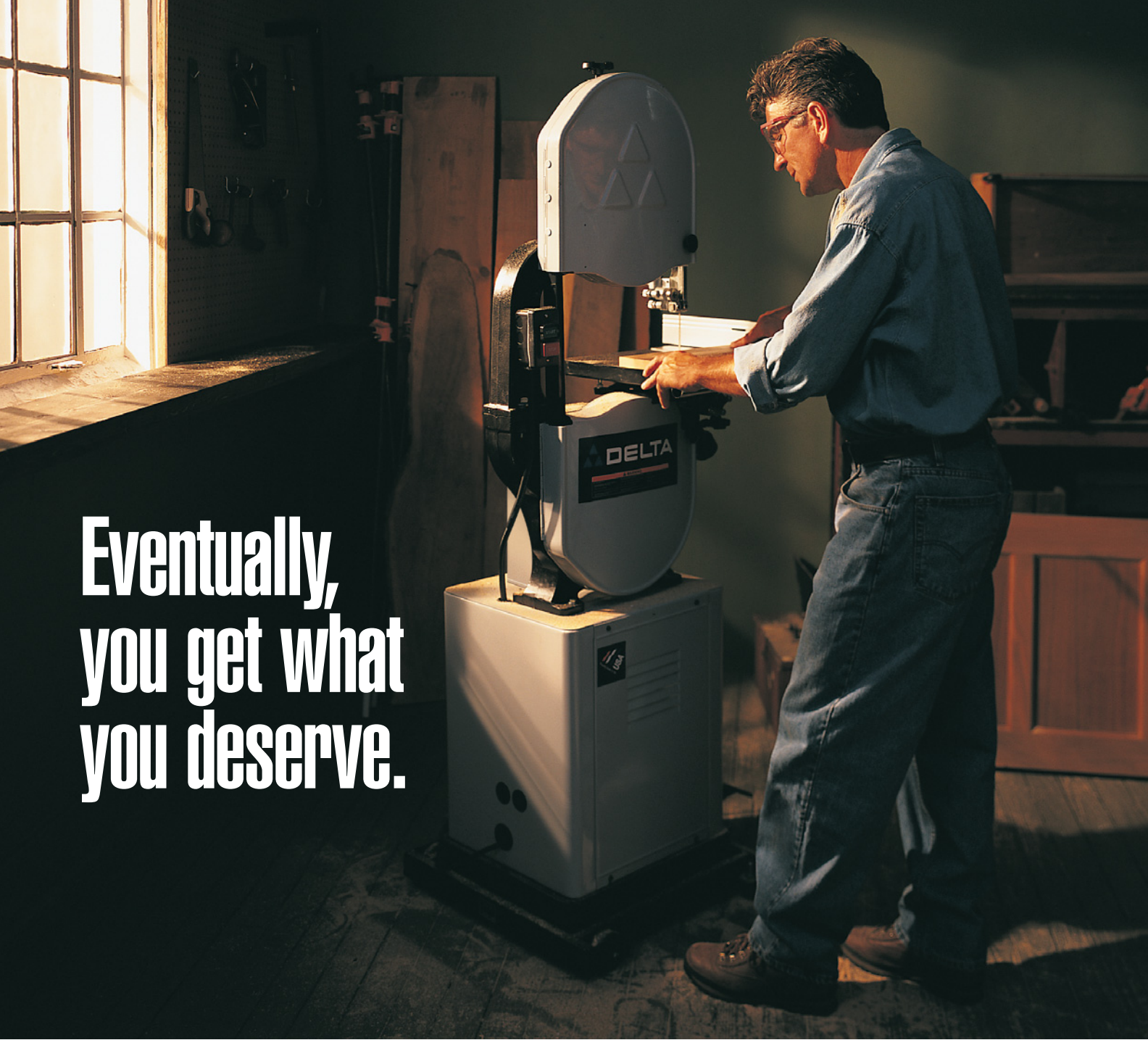

Eventually,
you get what
you deserve.

Get hundreds of dollars worth of free accessories
with these **Limited Edition** Delta machines.

All the time, all the effort, all the talent. You put a lot into your woodworking. Which is why we've put together a deal you can get a lot out of. Right now, buy any one of 11 Delta machines – the same tools seasoned woodworkers have always relied on for uncompromising quality – and we'll give you a long list of accessories absolutely free. From mobile bases to cast-iron wings, table boards to carbide-tipped saw blades* The way we see it, you've got it coming to you. For the name of your nearest dealer, call Delta Machinery at 800-438-2486 (U.S.) or 519-836-2840 (Canada). Or visit deltamachinery.com.



Delta is a proud sponsor of these PBS programs.

*Accessory packages vary by product.

Circle #119 on Reader Service Reply Card

DELTA[®]
SERIOUS WOODWORKING TOOLS SINCE 1919.