

15 Best New Tools of 2007: Our Opinionated Picks

DECEMBER 2007
ISSUE #166

POPULAR WOODWORKING

Learn How. Discover Why. Build Better.

Shaker Workbench

Rock-solid Design has
Storage in Spades

**Shoe
Polish:**
The Secret
To an 18th-
Century
Finish

PLUS

- Better Dovetails With a Jig
- Stickley Poppy Table
- Turn a Top (or 1,000)





43



57



62

36 Gustav Stickley Poppy Table

Gustav Stickley is best-known for his rectilinear Craftsman pieces, but this early (and somewhat unknown) table shows his early experimentation with Art Nouveau.

BY ROBERT W. LANG

43 Practical Safety Devices

WOODWORKING ESSENTIALS

Guards, push sticks and featherboards are meant to protect us, but their poor design can sometimes make machine operations dangerous or inaccurate. Here, we offer devices and safety rules that really work, and don't interfere with your woodworking.

BY MARC ADAMS

57 Best New Tools of 2007

It's hard to believe that in a craft almost as old as civilization itself, new and better tools continue to be developed every year—but they are. And here are our 15 favorites from 2007.

BY THE POPULAR
WOODWORKING STAFF

62 21st-Century Shaker Workbench

If you like looking at furniture as much as you like building it, this is the workbench for you. The stack of drawers, raised-panel door and traditional case construction create lots of space for tools. The top and vises make it a functional workbench for both power- and hand-tool users.

BY GLEN D. HUEY

72 Variable-Spaced Dovetails by Jig

With these two innovative methods, you'll no longer be a slave to your dovetail jig when deciding how tall your drawers should be.

BY DON MEANS



72

Number 166, December 2007. *Popular Woodworking* (ISSN 0884-8823, USPS 752-250) is published 7 times a year in February, April, June, August, October, November and December by F+W Publications, Inc. Editorial and advertising offices are located at 4700 E. Galbraith Road, Cincinnati, Ohio 45236; tel.: 513-531-2222. Unsolicited manuscripts, photographs and artwork should include ample postage on a self-addressed, stamped envelope (SASE); otherwise they will not be returned. Subscription rates: A year's subscription (7 issues) is \$19.96; outside of the U.S. add \$7/year • Canada Publications Mail Agreement No. 40025316. Canadian return address: 2835 Kew Drive, Windsor, ON N8T 3B7 • Copyright 2007 by *Popular Woodworking*. Periodicals postage paid at Cincinnati, Ohio, and additional mailing offices. Postmaster: Send all address changes to *Popular Woodworking*, P.O. Box 420235, Palm Coast, FL 32142-0235 Canada GST Reg. #R122594716 • Produced and printed in the U.S.A.

REGULARS



24

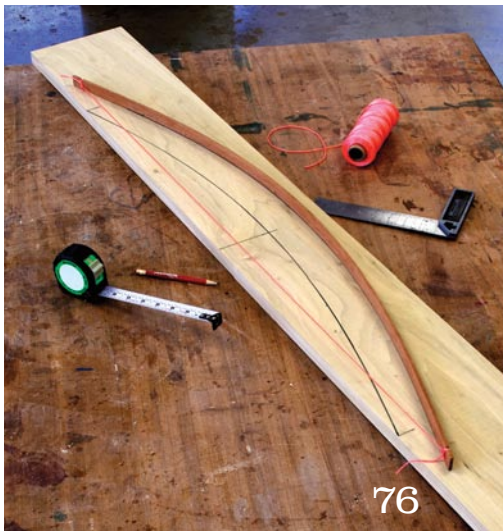

76



82

10 A New Way Not to Get Hurt
OUT ON A LIMB
BY CHRISTOPHER SCHWARZ

12 How to Use Handscrews
LETTERS
FROM OUR READERS

16 Low-Cost Leg Vise
TRICKS OF THE TRADE
FROM OUR READERS

24 Finishing Touch
ARTS & MYSTERIES
BY ADAM CHERUBINI

28 Mission Chair
I CAN DO THAT
BY GLEN D. HUEY

32 Veritas Small Plow Plane
TOOL TEST
BY OUR STAFF

76 Draw Perfect Arcs
JIG JOURNAL
BY ROBERT W. LANG

82 Turning Tops
AT THE LATHE
BY JUDY DITMER

90 Understanding Solvents
FLEXNER ON FINISHING
BY BOB FLEXNER

96 The Boys In the Guild
OUT OF THE WOODWORK
BY JEFF SKIVER

ON THE DECEMBER COVER



This Shaker-style workbench is as practical as it is nice to look at, with plenty of benchtop workspace and built-in tool storage. Page 62.

COVER PHOTO BY AL PARRISH



28



Video

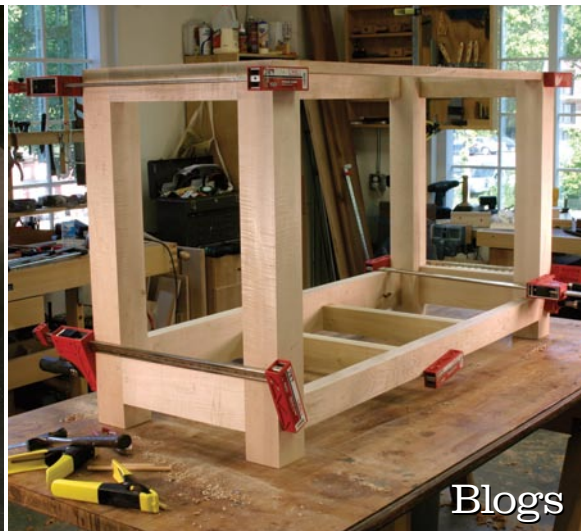

Blogs



Extras

Video Gallery

Editor vs. Editor On Hybrid Table Saws

The hybrid table saw test from the November 2007 issue generated a lot of discussion amongst the editors. We've captured the highlights on video so you can see what features appealed to who, and why.

popularwoodworking.com/video

On the Blogs

PW Shop Projects

Senior Editor Glen D. Huey built the Shaker Workbench in this issue (page 62) – but would Shaker craftsman Freegift Wells approve? Glen discusses his design process and decisions.

popularwoodworking.com/blogs

New This Month: Weaving a Shaker- Tape Chair Seat

"I Can Do That" Extras

This month's Mission chair project in the I Can Do That column is from our brand-new I Can Do That project book (from Popular Woodworking Books). We didn't have room to explain how to weave the chair's seat, so we've posted step-by-step instructions and suppliers for you online.

popularwoodworking.com/dec07

Poppy Table Extras

Senior Editor Robert W. Lang has posted a lot of thoughts on our blog about his building process for this Gustav Stickley piece. Plus, he drew up full-size project plans that you can download (for a small fee) and print for your shop.

popularwoodworking.com/dec07

Project Plans

Lost Stickley Side Table

If you like the Poppy Table in this issue, check out the free plans for a Gustav Stickley side table that's a bit of a mystery. The table showed up in a modern auction recently. After building it, we think we know why the attractive table never appeared in the company's catalog.

popularwoodworking.com/projectplans

Rules for Workbenches

Earlier this year, we promised 2007 would be the "Year of the Workbench." To round out 2007, we published a lengthy piece on the rules for designing (or buying) a good workbench.

popularwoodworking.com/toolstechniques

No-fail Dovetails

Managing Editor Megan Fitzpatrick has been practicing dovetails using a method developed by Senior Editor Glen D. Huey. We sum up his technique and give you a progress report on Megan's tails and pins.

popularwoodworking.com/projectplans

And More!

Visit popularwoodworking.com/dec07 to find a complete list of all the online resources for this issue – including videos, additional drawings and photos.

popularwoodworking.com

- [Contact Customer Service](http://popularwoodworking.com/customerservice)
- [Free Project Plans](http://popularwoodworking.com/projectplans)
- [Article Index](http://popularwoodworking.com/articleindex)
- [Tool Reviews](http://popularwoodworking.com/toolreviews)
- [Magazine Extras](http://popularwoodworking.com/magazineextras)
- [Editor Blogs](http://popularwoodworking.com/blogs)
- [Writer's Guidelines](http://popularwoodworking.com/writersguidelines)
- [Contact the Staff](http://popularwoodworking.com/contactus)

Glen D. Huey, senior editor of *Popular Woodworking*, has settled into his new role as a magazine editor (and our resident power-tool guy, videography expert and guy with the largest truck) after almost two decades of work as a professional cabinetmaker, teacher and freelance author. His web site (where you'll find all of his books and videos) is woodworkersedge.com.

Right now, in addition to his editorial duties for the magazine, Glen is working on a new book, "Finish Trim Carpentry for the Homeowner" (Popular Woodworking Books), which is scheduled to ship to bookstores in February 2008.

For this issue, he designed and built the Shaker-style workbench featured on page 62. This is the bench that Glen will be using in our shop in Cincinnati, and he employed many of his furniture-making talents in building the piece, from the stout post-and-rail base to the dovetailed drawers. The bench is designed for the modern woodworker who uses a lot of power tools, some hand tools and needs a lot of tool-storage space.



Jeff Skiver is a mechanical engineer who designs automobile parts, and he could usually be found with a wrench in his hand – that is until he stumbled into woodworking in 2004 when he built a sauna in his basement, and fell in love with it (both the woodworking and the sauna). Now, he's steadily working his way chronologically backward through various styles of fine furniture.

He notes that he's not afraid to make ugly furniture, citing as evidence a heartstopping pink and purple Arts & Crafts desk his niece requested. Jeff's "Out of the Woodwork" story (page 96) is his first for the magazine, and marks the last time he'll be welcome at his local woodworking club.



Robert W. Lang is a senior editor of *Popular Woodworking* and author of the definitive books of shop drawings for Arts & Crafts furniture, including the new "Shop Drawings for Greene & Greene Furniture" (Fox Chapel). See all his books and full-size plans at craftsmanplans.com. His article on the Stickley Poppy Table begins on page 36.

Don Means With a degree in mechanical engineering, Don has an inclination toward metalworking and machine tools. But after restoring a 1940s Walker-Turner table saw he acquired from a neighbor about 15 years ago, he decided to devote more time to woodworking and has been building furniture for friends and family ever since.

PUBLISHER & GROUP EDITORIAL DIRECTOR
Steve Shanesy

EDITOR Christopher Schwarz
x1407 ■ chris.schwarz@fwpubs.com

ART DIRECTOR Linda Watts
x1396 ■ linda.watts@fwpubs.com

SENIOR EDITOR Robert W. Lang
x1327 ■ robert.lang@fwpubs.com

SENIOR EDITOR Glen D. Huey
x1293 ■ glen.huey@fwpubs.com

MANAGING EDITOR Megan Fitzpatrick
x1348 ■ megan.fitzpatrick@fwpubs.com

PHOTOGRAPHER Al Parrish

CONTRIBUTING EDITORS

Adam Cherubini, Bob Flexner, Troy Sexton

F+W PUBLICATIONS INC.

CHAIRMAN & CEO David H. Steward

CFO John Speridakos

EXECUTIVE VP, INTERACTIVE MEDIA John Lerner

VP, MANUFACTURING Barbara Schmitz

DIRECTOR, IT Mike Kuehn

F+W PUBLICATIONS INC.
MAGAZINE GROUP

PRESIDENT Colin Ungaro

VP, CONSUMER MARKETING Sara DeCarlo

BUSINESS PLANNING DIRECTOR Tom Wiandt

CONFERENCE DIRECTOR Sara Dumford

CIRCULATION DIRECTOR Linda Engel

NEWSSTAND DIRECTOR Susan Rose

DIRECTOR, DIGITAL MEDIA SOLUTIONS Michael Kushner

PRODUCTION

PRODUCTION MANAGER Vicki Whitford

PRODUCTION COORDINATOR Katherine Seal

ADVERTISING

ADVERTISING DIRECTOR Don Schroder

331 N. Arch St., Allentown, PA 18104

TEL. 610-821-4425; FAX 610-821-7884

d.schroder@verizon.net

ADVERTISING PRODUCTION COORDINATOR

Nancy Miller, 513-531-2690 x1228

nancy.miller@fwpubs.com

SUBSCRIPTION SERVICES: Subscription inquiries, orders and address changes can be made at popularwoodworking.com (click on "Customer Service"). Or by mail: *Popular Woodworking*, P.O. Box 420235, Palm Coast, FL 32142-0235. Or call toll-free 877-860-9140 or 386-246-3369. Include your address with all inquiries. Allow 6 to 8 weeks for delivery.

NEWSSTAND DISTRIBUTION: Curtis Circulation Co., 730 River Road, New Milford, NJ 07646

ATTENTION RETAILERS: To carry *Popular Woodworking* in your store, call 800-894-4656 or write Magazine Retail Sales, P.O. Box 5014, Iola, WI 54945-5014.

BACK ISSUES are available. Call 800-258-0929 for pricing or visit popularwoodworking.com. Send check or money order to: *Popular Woodworking* Back Issues, F+W Publications Products, 700 E. State St., Iola, WI 54990. Please specify publication, month and year.



A New Way Not to Get Hurt

Woodworking writer Nick Engler has one leg that's shorter than the other – the result of a motorcycle accident years ago. When he talks about the incident now, he always starts off with a little joke.

“There are two kinds of motorcyclists,” he says. “Those who have been in a serious accident, and those who are going to be in a serious accident.”

Sadly, the same can be said of woodworkers. I know far too many friends, students and colleagues who have lost small bits of themselves to the awesome and dangerous machinery we work with all of the time.

If workshop injuries were a disease, they would probably be an epidemic. Yet, honest talk about safety in the workshop is rarely discussed or practiced here in North America. In my 11 years at this magazine, I've seen only two or three table saws in shops that had guards installed, and one of those shops was in Germany.

Of course, I know (as do you) that the current guard systems on table saws will frustrate you more than they will protect you. When I first started working with table saws every day, I tried to use a stock guard. I really did. But the splitter bent when you looked at it funny. The anti-kickback pawls were worthless, and the blade cover moved so stiffly I had to jam the work under it with all my might. That's not how guards are supposed to work.

Lucky for us, things are changing. And I hope that you're willing to change, too.

New table saws in the United States are incorporating European-style features, such as a riving knife and a quick-change blade cover. These make the saw immensely safer – if you have them installed. And that's where Marc Adams comes into this picture.

During the next year, he's going to be writing about how to work safely and accurately in the shop for our Woodworking Essentials series. Before your eyes glaze over, I hope you'll think about this for a minute.

Adams runs the largest woodworking school in North America and has more than 2,500 students every year. I've watched him teach safety to his students, and he's not just quoting from a manual or textbook. In fact, he's sometimes at odds with them.

His approach to safety is practical. It allows you to do accurate work with ease. And it's not going to get in the way of basic or even advanced operations. Most of all, when you try these methods (especially his 12" and 3" rules) you'll notice a different feeling in your gut because the chances of you getting hurt have dropped to nil.

I've taken Adams's methods of work to heart, and I'm glad I did. It feels like driving to the corner store in a Sherman tank – instead of on a motorcycle. **PW**



Christopher Schwarz

PHOTO BY AL PARRISH

Customer Service

How can I contact customer service with questions regarding my subscription, including a lost or damaged issue?

Visit popularwoodworking.com/customerservice. Or write to *Popular Woodworking*, P.O. Box 420235, Palm Coast, FL 32142-0235. Or, if you prefer the telephone, call toll-free 877-860-9140 and a customer service representative will be happy to help you.

When does my subscription expire?

The date of your subscription expiration appears on your magazine mailing label, above your name. The date indicates the last issue in your subscription.

Can I get back issues of Popular Woodworking?

Back issues are available while supplies last. Visit popularwoodworking.com/backissues. Or if you know the exact month and year of the issue you want, call our customer service department toll-free at 800-258-0929 to order.

What if I want more information about the projects and tools I read about in Popular Woodworking?

For all editorial questions, please write to Popular Woodworking Editorial, 4700 E. Galbraith Road, Cincinnati, OH 45236. Or e-mail popwood@fwpubs.com.

Does Popular Woodworking offer group discounts?

Group discounts are available by special arrangement with the publisher. For more details, send an e-mail to debbie.paoello@fwpubs.com or call 513-531-2690 ext 1296.

Our Privacy Promise to You

We make portions of our customer list available to carefully screened companies that offer products and services we believe you may enjoy. If you do not want to receive offers and/or information, please let us know by contacting us at:

List Manager, F+W Publications
4700 E. Galbraith Road
Cincinnati, OH 45236

Safety Note

Safety is your responsibility. Manufacturers place safety devices on their equipment for a reason. In many photos you see in *Popular Woodworking*, these have been removed to provide clarity. In some cases we'll use an awkward body position so you can better see what's being demonstrated. Don't copy us. Think about each procedure you're going to perform beforehand.

What's the Trick to Adjusting Handscrew Jaws to Parallel?

In your "Mobile Clamp Cart" article in the October issue (#164) you show wooden handscrew clamps, and you've recommended them on the blog. I have a few, but I have trouble keeping the jaws parallel. I'm sure there's a trick to it, but I can't seem to figure it out on my own. Can you help?

— Steve Janiak, Missoula, Montana

One of the good things about wooden handscrews is you can get the jaws out of parallel if you need to – if, for example, you want to apply pressure at the just tips of the jaws. However, most of the time they work best when the jaws are parallel. If you spin them all the way closed, it's easy to adjust one of the screws to get them lined up. Then, you spin them back open to where you need them. When I have them in position for final tightening, I bring the inner part of the jaw down on the work, then it's just a twist or two of the back handle to bring the tips down on the work.

— Robert W. Lang, senior editor

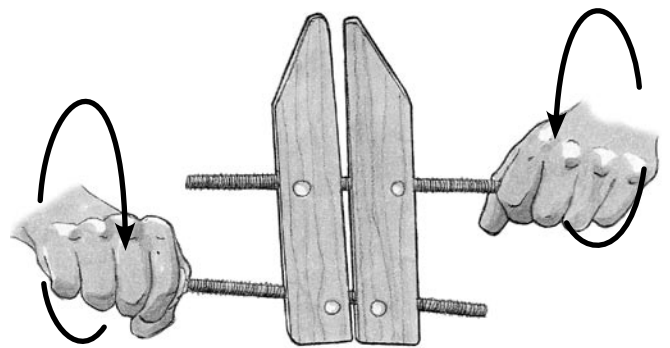

1. CLOSE THE CLAMP

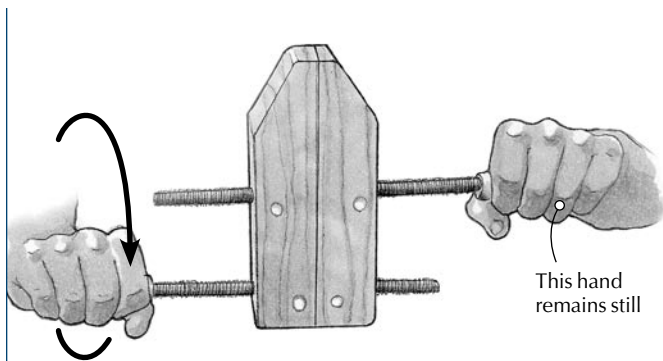

2. ADJUST TO PARALLEL

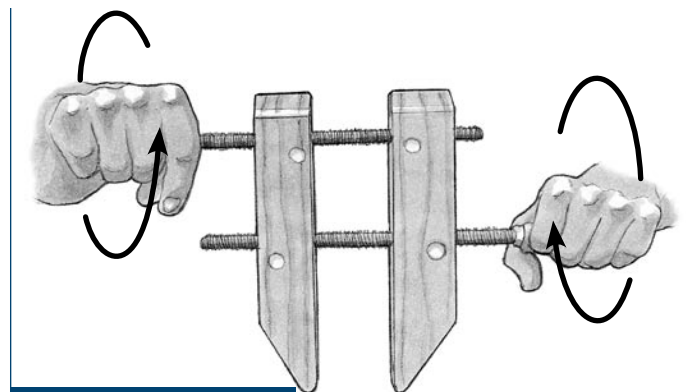

3. OPEN THE CLAMP

Workshop Planning: What's the Best Location for my Bench?

I'm a beginning woodworker and in the process of planning my first shop. After a lot of reading I've decided to stick with hand tools exclusively, at least in the beginning. My question is, where do I set up shop?

My basement and garage are possibilities but they are small and uninspiring. Living

in Ohio, I'm also concerned about heating, cooling, humidity and rust.

Then I thought about using the sun room off the kitchen (I have a very understanding wife). It's perfect: large size, high ceilings, windows everywhere and a view of all the trees in the back yard. It's my favorite room in the house. My only concern is with dust because this room is very open to the rest of

the house; there are no doors to close it off.

If I use hand tools exclusively, do you think dust will be a problem, or will I mostly be dealing with larger chunks and shavings? I don't mind keeping a tidy shop, but I'm concerned about the health issues associated with breathing in dust and creating an unsafe environment for my family. I know this would be a legitimate concern

CONTINUED ON PAGE 14

ILLUSTRATIONS BY HAYES SHANESY

if I put a table saw or router in that room, but with hand tools, is this still an issue?

— Brad Nunn, Medina, Ohio

We have a sun room, and that is exactly where I would put my bench if I could. You are thinking along the right lines.

As to dust and shavings: If you are going to work with hand tools, I don't think you'll have much (if anything) to worry about. The dust that damages your lungs is the extremely fine particulate – stuff that's less than a micron in size. Hand tools make little (if any) of this stuff. It's the sanding tools that are responsible for a good deal of the really fine, choking stuff.

You might want to consider doing your finishing elsewhere, however. It can be stinky – unless you use water-based finishes or shellac.

Good luck with your new shop.

— Christopher Schwarz, editor

Pre-Civil War Disston Saw: OK to Use it, or Should it be Preserved?

My father-in-law knew of my interest in hand tools and gave me an old saw he had in his garage. It turns out it is a pre-1865 Disston.

My best guess from the Disstonian Institute (disstonianinstitute.com) is that it is a No. 7 and probably an 1840s or 1850s model based on the medallion. It has an 18" blade filed with 10 ppi crosscut with the nib intact. The idea of using a saw made when or before Abe Lincoln was president kind of appeals to me, but I don't want to be an idiot. What's the best way to take care of it? Can I clean it? It's dirty but has no rust. Can I use brass cleaner on the medallion to make it more visible?

— Tom Kelley, via e-mail

I use saws that are that old. They are not terribly common, but not terribly valuable either. Only a few saws fetch more than \$200 in the collector market. So I'd use it, if you are so inclined.

As to cleaning it, Pete Taran of Vintage Saws has an excellent tutorial on his web site "library" page at vintagesaws.com, which should get you going on cleaning and filing the saw.

— Christopher Schwarz, editor

Benchtop Planer Cutterheads

I am looking into purchasing a benchtop planer, but I am curious – can I upgrade any of the existing brands' blades later with a heli-



cal cutterhead? I have not been able to find any aftermarket kits on the web, and it seems that only the large planers are available with them, and at a substantial cost.

— Gordon Corlette, via e-mail

In the tool world the lunchbox (benchtop) planers are considered disposable, as are the knives (you get two edges to use before buying another set – no sharpening). I know it's a terrible way to think of these tools because they work great in home and small shops, but that's the way it is. As a result, you'll not find any helical heads to replace the existing cutterhead.

Another reason for no replacements is that the design or diameter of the head on the benchtop tool is small, and the engineering of the helical head requires a larger diameter for installation of the inserts.

— Glen D. Huey, senior editor

Fighting Hand-tool Rust in Florida

I have a question about tool storage and humidity. I live in Florida and have no way to control humidity in my garage shop, so I'm constantly fighting rust on my hand tools. I want to build a wall-hung tool rack, but I was wondering if I would gain any protection for the tools and from humidity if I built an enclosed storage cabinet instead of an open rack.

— Jerry E. Flowers, Lynn Haven, Florida

As to tool storage, Cincinnati is quite humid as well. My basement is even worse. My tools stay out in the open and rust-free because of good working habits. I wipe down every tool after use and before it gets put away with a rag soaked in lubricant. I keep dust off of the tools (dust attracts salt and moisture). I clear all shavings from the mouths and escapements of my tools.

The kind of lubricant isn't terribly important. WD-40 will work. I use Camellia oil or Boeshield T9. There are lots of alternatives available as well. The real trick is not in your cabinet or rack, but in establishing good habits before you store your tools.

— Christopher Schwarz, editor

Clock Movement Options

I'm a woodworking teacher in Factoryville, Penn. I just started the new school year, and I have two students who are interested in making the tall Shaker clock from the August 2007 issue of *Popular Woodworking* (#163), but the price tag of the movement (\$375) might hold them back.

Are there any suitable replacements that do not have such a high cost? My students tend to have part-time jobs after school, and I think \$100-\$150 will be their limit.

— John Brander, Factoryville, Pennsylvania

My suggestion would be to build the clock as shown, but install a simple quartz movement such as the "standard quartz movement" (without the pendulum) that Woodcraft offers for \$8.99 (woodcraft.com).

If you do find a less expensive bell-strike movement, pay attention to the case size (and, let me know where you found it!). The movement needs to be able to work within the confines presented by the case (this won't be pose a challenge with the much smaller quartz movements).

— Glen D. Huey, senior editor

Please Stop Perpetuating Fear of Grade-school Mathematics

I am a mathematician and a woodworker. While I enjoy *Popular Woodworking* immensely, there is something that you do that drives me crazy. In the October 2007 issue (#164), I saw the word "Caution" in one of the picture captions. What could it be cautioning against? Could there be an important safety issue? Would constructing the panel-cutting sled require putting one's hand closer to the blade

than is safe if one wasn't paying attention? No! We were cautioned because there was some geometry coming straight for us!

Please – let's get a little perspective here. Woodworkers use tools that can dismember if not outright kill. On the previous page in the issue, there is a picture of a table saw without its blade guard (which I am certain was removed only for the clarity of the picture – woodworkers never work without the blade guard), but the warning is because the Pythagorean theorem is used to ensure a right angle.

I have seen this in your magazine several times – warnings that some aspect of the design might require doing a little figuring or methods of marking designed to avoid, horror of horrors, fractions.

Fractions and the Pythagorean theorem are grade-school mathematics. We learned these things before we were tall enough to use a table saw. We shouldn't need to be warned about them, and more important, we shouldn't be scared of them. Mathematics is a necessary part of design – you should be embracing it instead of perpetuating fear, even if you think it is somewhat tongue-in-cheek. **PW**

— Chris Kennedy, Ph.D.

Department of Mathematics
Christopher Newport University
Newport News, Virginia

Question? Comment? We want to hear from you.

Popular Woodworking welcomes comments from readers about the magazine or woodworking in general, as well as questions on all areas of woodworking. We are more than happy to share our woodworking experience with you by answering your questions or adding some clarity to whatever aspect of the craft you are unsure about, and if you have a complaint, we want to address it whenever possible.

Though we receive a good deal of mail, we try to respond to all correspondence in a prompt manner. Published correspondence may be edited for length or style. All correspondence becomes the property of *Popular Woodworking*.

Send your questions and comments via e-mail to popwood@fwpubs.com, via fax to 513-891-7196, or by mail to:

Letters
Popular Woodworking
4700 E. Galbraith Road
Cincinnati, OH 45236

THE WINNER:

Low-tech, Low-cost Leg Vise

My tight finances forced me to devise an alternative to an expensive bench vise. This simple leg vise—cobbled together from a board, a 3/4"-diameter pipe clamp, and a short length of 1/2"-diameter pipe—works fine for many of my needs. As seen in the drawing, the pipe clamp extends through the vise jaw and bench leg, with the clamp's screw jaw attached to the vise jaw, and the opposite clamp jaw resting against the inner face of the bench leg. The "guide" pipe, screwed into the lower end of the vise jaw, floats in a hole in the bench leg to help stabilize the vise jaw and prevent it from rotating. It also jams in its hole under pressure to serve as a sort of holdfast for the jaw. A shim board attached to the face of the bench's leg brings its clamping surface flush with the front edge of the benchtop.

To build the vise, I clamped the wooden vise jaw against the leg and drilled a 1"-diameter hole for the 3/4"-diameter pipe clamp, using a spade bit and a portable drill guide to keep the hole perpendicular to the face of the bench leg. (Editor's note: For an alternative approach, see "Help with Horizontal Holes," p. 20.) After removing the jaw, I drilled the 1"-diameter hole for the guide pipe. I then aligned the jaw again and drilled through the guide-pipe hole from behind the leg to locate the lower hole in the jaw. To attach the guide pipe, I simply screwed its threaded end into an appropriately sized blind hole in the jaw, although you could screw it into a pipe flange fastened to the jaw. I attached the head of the pipe clamp to the jaw using rabbeted wood blocks, but you could drill holes through the jaw and attach it with screws instead for a neater, less obtrusive appearance.

The vise is easy to use. For most of my clamping needs, the throw of the clamp screw provides enough clamping capacity. However, when I need to clamp large pieces, it's easy to reach behind the leg to adjust the rear clamp jaw for a larger opening. On the few occasions that the lower guide pipe won't lock in position under pressure, I simply clamp a pair of locking pliers onto the pipe against the front of the leg.

— Thomas Porter, Buena Vista, Virginia

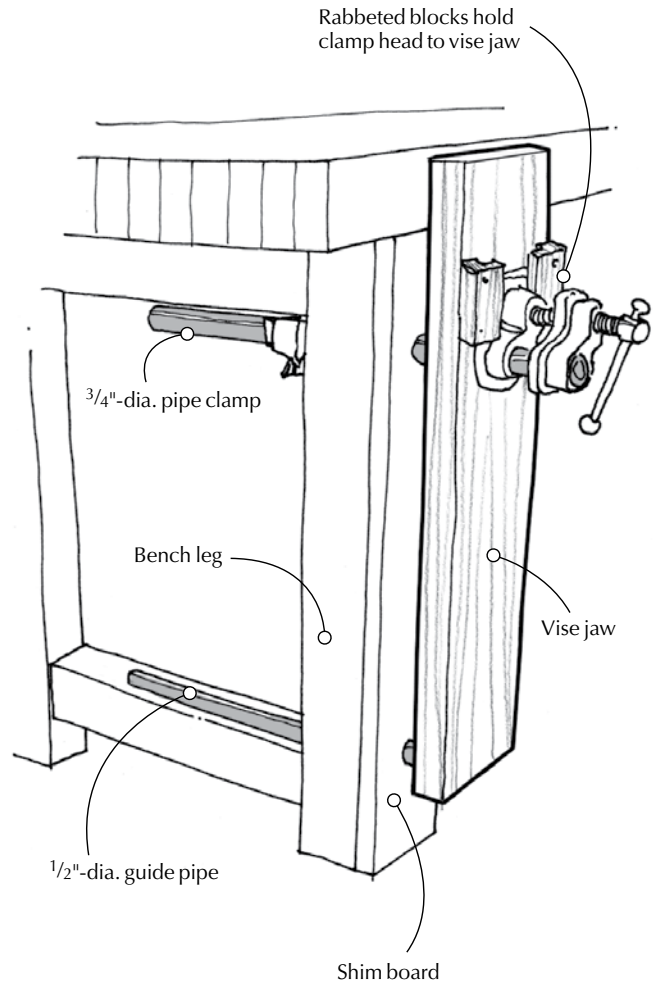

CONTINUED ON PAGE 18

Cash and prizes for your tricks and tips!

Each issue we publish useful woodworking tips from our readers. Next issue's winner receives a \$250 gift certificate from Lee Valley Tools, good for items in the catalog or web site (leevalley.com). (The tools pictured at right are for illustration only, and are not part of the prize.)



Runners-up each receive a check for \$50 to \$100. When submitting a trick (either by mail or e-mail) you must include your complete mailing address and a daytime phone number. If your trick is selected for publication, an editor will need to contact you. All entries become the property of *Popular Woodworking*. You can send your trick by e-mail to popwoodtricks@fwpubs.com, or mail it to Tricks of the Trade, *Popular Woodworking*, 4700 E. Galbraith Road, Cincinnati, OH 45236.



Simple Switch Safety

I like to buy used electric motors for powering various tools around the shop. I also use them to mount grinding wheels, wire brushes and buffing wheels. I typically outfit the motors with toggle switches because they're light and small. However, as unobtrusive as they are, I would occasionally catch my sleeve on a switch, accidentally turning on a motor.

This led me to come up with a simple and safe solution. I cut a short length of aluminum channel and then drill a hole to accept the switch barrel. I mount the channel on

the switch, with the switch motion oriented toward the open ends. The channel protects against accidental starting, yet it's no problem to insert my finger to flip the switch on. This approach also works as well on any remotely mounted switch, such as one you might mount on your router table cabinet.

—Serge Duclos, Delson, Quebec

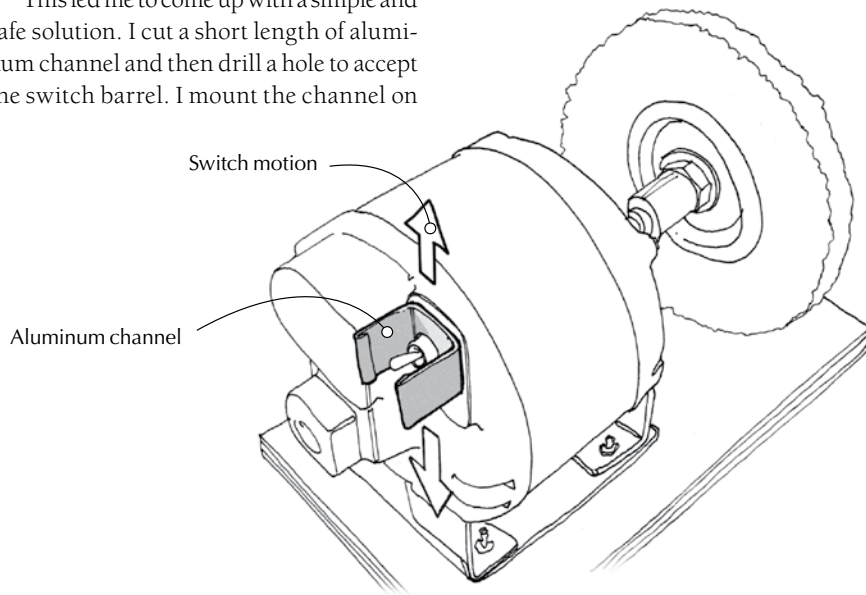

Better Brush Care

One of my favorite finishes is high-grade polyurethane, which I apply with a premium-bristle brush for the best results. Unfortunately, cleaning these rather expensive brushes always seemed to leave some residue, especially near the ferrule. Over time, the hardened residue compromised the effectiveness of the brush.

I've finally worked out a cleaning routine that leaves a brush in the softest condition possible. I begin by using a rag to squeeze out as much residual finish as possible from the brush. Then I rinse the brush twice in clean mineral spirits. Now here's the trick: Clean the brush thoroughly using citrus-based hand cleaner. (Note: Don't use hand cleaner with grit in it.) Sold at home supply stores under names like "Orange Goop," the cleaner does a great job of removing residual finish and spirits. Use about one tablespoon per inch of brush width, working it thoroughly into the base of the bristles, then follow up with a thorough rinse under warm running water. Finally, wrap the bristles in paper to prevent them from frizzing up.

— Michael Sargent, Urbana, Illinois

Clean, Safe Panel Routing

When routing raised panels for cabinet doors, two primary things concern me. One is that the panel profile be neat, clean and consistent. The other is that I don't accidentally stain the work with blood. The two router table accessories that help me achieve these goals are a featherboard and a bit guard. The featherboard holds the work firmly against the table throughout the cuts, ensuring a smooth profile with an edge that fits the stile groove perfectly. The bit guard, of course, keeps my fingers away from that frighteningly big and vicious cutter.

Unfortunately, some guards can impede the use of featherboards, or vice-versa. To allow the use of both, I cobbled up this wrap-around guard that clamps to the router table fence along with my $\frac{3}{8}$ "-thick featherboard. It's simple to make, and consists of just two pieces of hardwood glued to each other at a right angle. The $\frac{1}{2}$ "-thick wider piece, which clamps to the fence, is angled at the business

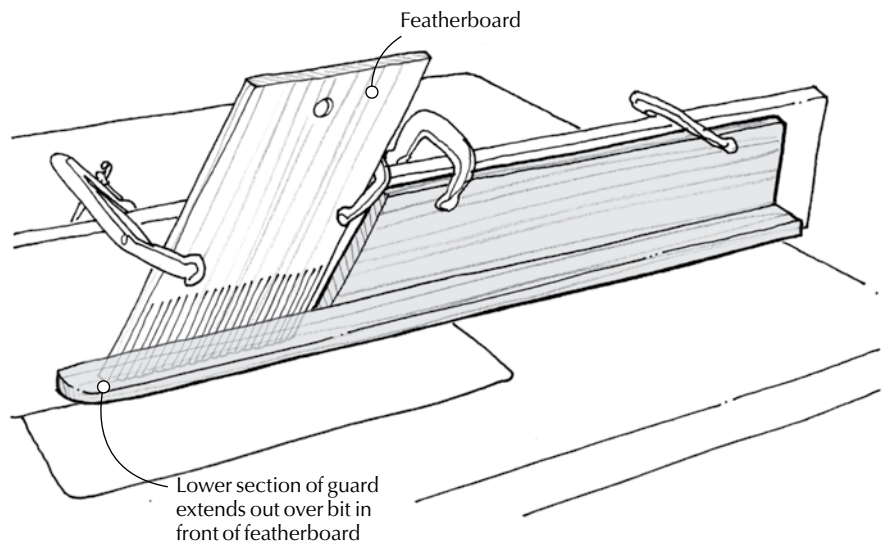

end to accommodate the slope of the adjacent featherboard. The $\frac{3}{8}$ "-thick narrow piece extends out around the featherboard, and over the bit. You can use any thickness of stock you like; just allow enough room so the guard

doesn't press against the featherboard. To use, set up your featherboard first, then clamp the guard to your fence so that it rides just slightly above the workpiece panel.

— Paul Anthony, PW contributor

Help with Horizontal Drilling

Drilling horizontal holes with a spade bit can be difficult. With standard twist drills, you can guide the bit with a block that was bored on the drill press, but the wide flare and narrow shank of a spade bit won't allow that. Recently I needed to drill some large holes for conduit that had to run level through a wall. Fortunately I remembered a trick a clever codger showed me one time. I strung together a couple large washers with a piece of string, and I slipped one of them on the bit shank when chucking up the bit. The hanging washer provided enough weight to make the upper washer "walk" on the spinning drill bit shank whenever I errantly tilted the drill. As long as I managed to keep the washer from wandering while drilling, my hole ended up level. This also allowed me to focus my attention on keeping the drill square side-to-side in order to bore a hole perpendicular to a vertical surface. A small square placed beside the bit helped too.

— Russ Tranger, Seattle, Washington

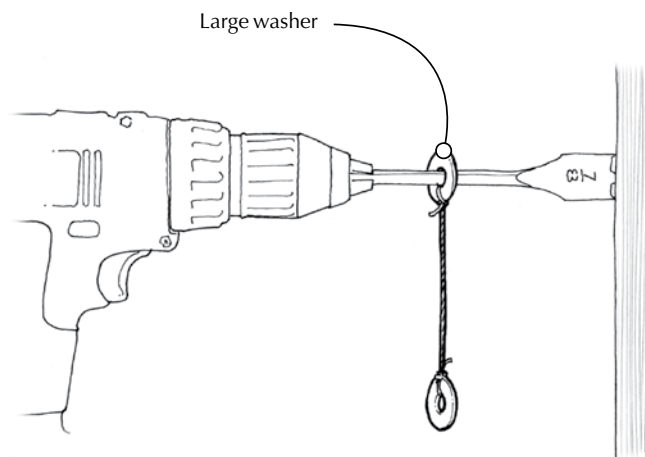

Go-bar Clamping

A large amount of my work involves antique restoration that often requires gluing down loose veneer or inlays in the center of large tabletops and other panels. Rather than drag out my vacuum press for a small repair, it's often easier to use go-bars. A technique borrowed from the world of lutherie, go-bar clamping is often used by guitar makers to clamp braces onto soundboards and guitar backs. A go-bar is nothing more than a flexible wooden bar compressed between the workbench and the ceiling to provide downward force on a clamping pad. For the bars, I use $\frac{3}{4}$ "-square straight-grained oak rippings. For clamping pads, I use $\frac{1}{4}$ "-thick acrylic, which is glue-resistant and clear, which helps in positioning.

The tricky part of go-bar clamping is keeping the bar in place against the ceiling while positioning the clamp pad. My ceiling mounted "trap" solves this problem. It's nothing more than a 2x4 with V-grooves sawn into it. Retaining strips tacked onto the long edges keep a go-bar from sliding sideways out of its notch. I cut the assembly to the length of my workbench, and I screwed it to the ceiling joists over the center of the bench. Now I can just locate the upper end of a go-bar in an appropriate groove while concentrating on my work at the business end.

— Craig Bentzley, Chalfont, Pennsylvania

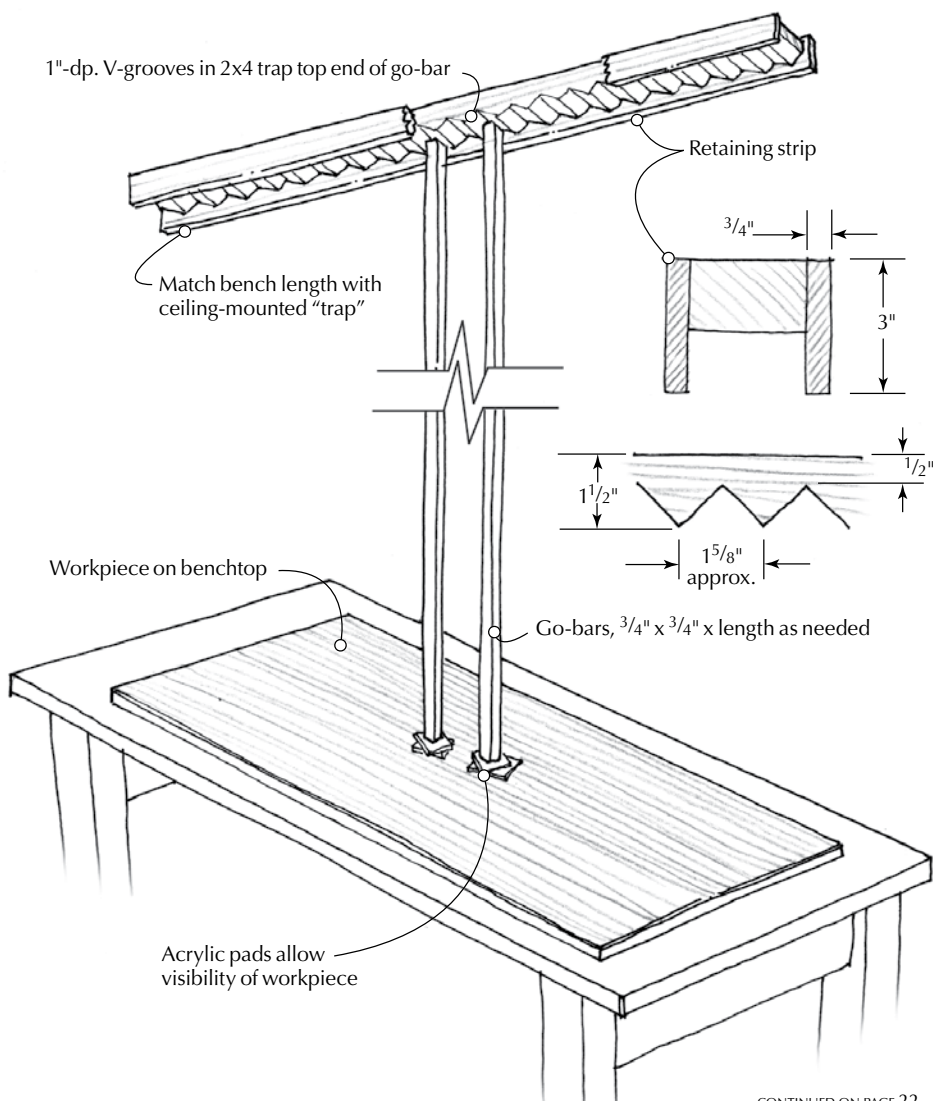

Band Saw Blade Bins

I don't think anything steals productive shop time more than having power-tool accessories scattered all over the shop. I've built storage for most of my tool accessories except for my 14" band saw blades, which never found a good home. The solution to the problem came to me in my office one day when using my wall-mounted file bins. It dawned on me that they would provide great blade storage.

Available at most office supply stores, the bins can be mounted to a saw base using two sheet metal screws each, along with the double-stick tape provided with the bins. I chose to use plastic bins instead of metal, so as to not dull the blade teeth. Each bin can hold two or three blades, depending on the blade width. Now the blades are always right at hand at the saw. It's a great way to stay organized. **PW**

— David Ferguson, Cloverdale, California



Plastic wall-mounted file bins

Attach with sheet metal screws and double-stick tape

The Standing Desk, Finished

Built with traditional joinery and tools, this year-long project looks at home in an 18th-century shop.

This is the last article in my year-long series on building a standing desk for my shop. In this article I'll show the various activities required to finish this piece. For me, finishing encompasses all the work that takes place after the structure is complete. So we'll look at making mouldings, application of paint and film finishes, and the attachment of hardware.

Function of Mouldings

Mouldings serve important aesthetic functions. They punctuate design elements, ease transitions and describe the structure. Convex mouldings indicate mass. Base mouldings bulge under the weight of the structure above. Your eye rolls around the convex moulding, tracing its outline.

Concave mouldings blend suspended surfaces. Crown mouldings are usually concave. The eye slides along the concave moulding moving from one surface to another.

Making a Bolection

You can use "generic" hollow- and round-soled moulding planes to make just about any shape of moulding you desire. I used my hollows and rounds to make the bolection profile for my base mould. The bolection profile is comprised of three basic shapes, the half-round astragal, a fillet or flat spot, and a concave shape called a cove.

Exterior Finish

There was considerably more painted furniture in the 18th century than the surviving examples would lead us to believe. Documentary evidence tells us some furniture was painted to look like more expensive woods. This lesser-quality furniture simply hasn't survived to our time. We also know that many maple pieces, today appearing to have natural



New design, traditional techniques. Built with traditional joinery and period hand tools, this standing desk looks like it would be at home in the 18th century. But this desk is no copy. I've never seen anything quite like it. Using the techniques I covered in this year's Arts & Mysteries column, you can build authentic furniture without even a picture for inspiration.

finishes, were originally painted to look like mahogany. People liked dark furniture then, and paint was a good way to get the high-end look of mahogany or walnut from pine, tulip poplar or maple.

Period paints were overwhelmingly oil-based, not casein- or milk-based, but don't sue your Windsor chairmaker for fraud just yet. Period oil-based paints were made of coarse ground pigments, white lead, linseed oil and turpentine. Depending on the amount of linseed oil added, they could have a glossy or matte finish. Depending on the amount of white lead added, they could be somewhat translucent or as opaque as our paints.

In truth, they were unlike our paints in only two noticeable ways. According to Williamsburg's Furniture Conservator Chris Swan, the surface finish could be described as "ropey," with long raised rope-like strands of oil. Second, the hand-ground pigment was much coarser than our modern pigments. Consequently, the paint's color could vary slightly from batch to batch or even within a single batch.

Though skilled conservators such as Swan would never agree, I find milk paint, with its

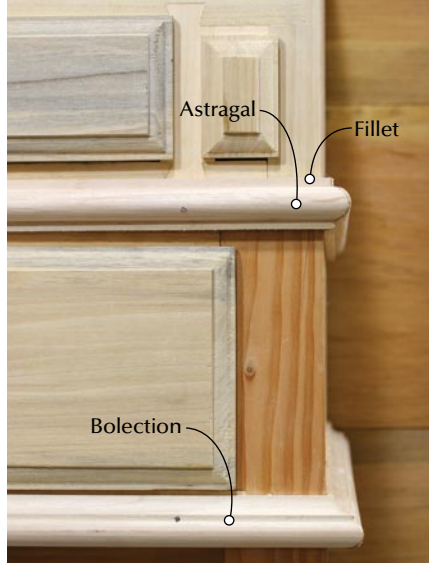

Moulding selection. I chose a bolection for the base moulding. This moulding helps finish the bottom of the case, allowing the viewer to see the carcass as separate from the legs. It supports the "elevated mass" look that was popular in the early 18th century. I chose an astragal with fillets as the waist mould. This moulding binds the upper and lower cases.

relatively coarse-ground natural-earth pigments, an excellent substitute for the toxic paint of the 18th century. Like many modern Windsor chairmakers, I have my own ways of working with it to approximate period paint finishes.

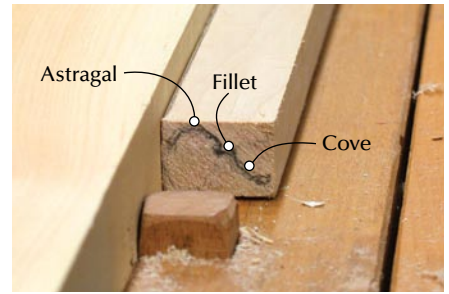

Freehand. I began my bolection by free handing the shape on either end of the stock. You don't need a special template for this. This rough sketch is fine.

Oiling and Waxing

By rubbing out the milk paint, you can control its opacity to simulate period paint. I then apply linseed oil and paste wax to get the shine I'm looking for, again simulating whatever age and wear characteristics I'm going for. The last step is adding a few years to the finish.

Famed furniture dealer Israel Sack valued what he called "grunge" – dirt and soot on the surface of furniture that indicated an old finish was present. According to David DeMuzio, senior conservator of furniture and woodwork at the Philadelphia Museum of Art, grunge is



Fillister plane. I began the bolection by planing the fillet using my moving fillister plane. This moulding will wrap around three sides of my desk, so the stock is about 7' long. As you can see, I clamped a piece of scrap pine to my bench using these wimpy modern clamps. I lent my good beech handscrews to a friend doing a period demonstration.



Fore plane. I flipped the moulding end for end and quickly planed a flat where the cove will be using my fore plane.



Round plane. Using my fingers to guide the plane, I cut the cove with a round plane. The round plane does not make a quarter of a circle, so this took several passes, each at a slightly different angle to create the quarter-round cove.

black. Don't tell DeMuzio, but so is my shoe polish. Now I would never recommend you do this to a real antique or even a fine reproduction. But this is a piece that will likely never leave my shop. So I get to have a little fun with it. I've rubbed shoe polish into nooks and crannies, and wiped it away to leave the dark wax in places where a dusting rag would miss. This won't fool anyone into thinking the desk is an antique, but it will remove the shocking newness of the piece.

Hardware

Though it might seem like common sense, I've learned a few things about installing period hardware that may help you. Many of the pieces are irregular. Little knobs might have crooked screws that need straightening before use. Escutcheon plates might need to be filed to fit your keys. But authentic hardware is usually very soft brass and easy to work with.

When installing a bail pull, it's preferable that the bail initially be a bit too wide. This is one item you shouldn't fix before use. Start both posts in their holes in the drawer front and squeeze the bail pull between them. Using a soft mallet, tap each post in turn. As the posts get driven home, the bail will be squeezed into the right shape. The installed bails should not rattle.

The other trick to installing drawer pulls is positioning them. I've found that generally the pulls on period pieces are located in the center of the drawer, height-wise. To set the spacing side to side, I place the escutcheons .618 (golden section) x the drawer's width apart. I'm not sure this is always the case on early pieces but it never looks "wrong."

If you're going to install locks, be sure to plan ahead. I prefer to use a brace and center bit to excavate the half mortise for the lock. This is much easier to do before the drawer bottom is attached and even easier to do before the drawer sides are on. Cutting the keyholes is simple. You start with the hole. Traditionally, craftsmen used keyhole saws to saw out the bit beneath the hole. For me however, a coping saw works best.

Conclusion

In the beginning of this series, I promised you an unprecedented look at building furniture with hand tools. But I also wanted to show you how you can use traditional proportions, structures and tools to build authentic-looking pieces we've never actually seen.



Hollow plane. I've flipped the moulding again and now I'm working the astragal portion with a hollow plane. I'll do one side at a time then finish the top surface.



Uniformity is overrated. The finished moulding is not perfectly uniform from end to end. But it won't matter as long as I cut it into pieces and wrap them around the desk in order.



Just add water. Milk paint is available commercially as a powder. Just add water until it is the consistency of milk. Here I've mixed two parts of barn red with one part of Lexington green. The result will be a dark red. I mix single coats or less at a time, and don't measure my recipes too accurately. I'm looking for a little movement in the color.

For my daughter Genevieve, and the woodworkers of her generation, the state of the art of period woodworking will likely be very different than it is now. Future woodworkers won't be limited (as we have been) by museum collections and furniture dealers' coffee-table books. Armed with the tools, knowledge of basic shop practices (I suspect they will come to know specific shops' practices), and an understanding of finishes, and usage of pieces, they will have the ability to show us the 18th century that people knew back then. **PW**

Visit Adam's blog at artsandmysteries.com for more discussion of traditional woodworking techniques.



A family affair. My daughter Genevieve has been painting my furniture since she was 6 years old. She's an excellent painter. Notice her relaxed grip on the ferrule of the horse hair brush we made together. Some people think I'm crazy to cover authentically built furniture with inauthentic paint. I think milk paint is close enough, and I'd rather work with Genevieve than put on a space suit to avoid poisoning myself.



Ugly at first. I snatched the brush out of Genevieve's hand to snap this picture. The first coat always looks terrible. Runs, sags and lost brush hairs are irrelevant with milk paint. We're going to rub this finish out later. So put on one coat, let it dry for an hour or two, then see if you don't like the second coat better.



Knock down the chalk. Milk paint has a chalky texture when dry. But it can develop a pleasing sheen when rubbed out. I prefer to rub the surface with a cloth, or even something as abrasive as a used Scotch-Brite pad to remove the tooth of the milk paint. Just be careful not to rub too hard or you'll rub right through the paint.



Grunged-up. I think the key to obtaining a believable milk-paint finish is oiling and waxing it after the chalky texture is rubbed out. Oil will darken the finish, and I've added a little shoe polish to simulate a few years of grunge. Concentrate your grunging on upper surfaces where dirt would naturally collect.



Pulls. On desks with lopers (the pull-out desk-flap supports), the narrower upper drawers' pulls usually line up with the lower drawers' pulls. I followed this convention for my desk.



Hardware. This hardware from Londonderry brasses is very authentic and very beautiful. I think it's the finest reproduction hardware available. But it's so authentic that you may have to fiddle with it to get it to work!



Peek inside. The inspiration for my standing desk came from a late 18th-century tool chest. Cabinetmakers sometimes decoratively veneered the undersides of their chests' lids. Some chest interiors are beautifully appointed, rivaling the finest furniture of the time. A painting in Jay Gaynor's "Tools: Working Wood in Eighteenth Century America" shows an 18th-century cabinetmaker's office complete with a standing desk. But the desk is closed. I wonder if an 18th-century cabinetmaker might apply the same rough exterior, fine interior to other pieces of shop furniture besides his tool chest. This desk is my guess at how such a desk might look.

Simple Side Chair

A woven seat adds a punch of color to this surprisingly easy project.

After years of building furniture, mostly case pieces, I've come to understand that chair building is different. Where most casework involves working with panels and straight lumber, most chair building turns to bending stock or forming parts. When you find a chair that fits into the casework criteria, you should take every opportunity to build that piece.

This chair fits into that framework. I envision this chair sitting anywhere, from around the dining room table, to welcoming guests to your home in the foyer, to being perched beside the dressing table in your bedroom. It is sturdy, comfortable and the construction is beginner-friendly to say the least.

The focus of most chairs is the back and the seat. This chair appeals to the eye with the shapely hourglass back splat and the colorful seat that is woven with Shaker tape.

For Starters—Get a Leg Up

Building chairs begins with the legs. Because you've already got the width and thickness of the pieces (1½" square, which is a 2 x 2) by buying stock material from the home center, the next step is to cut them to length. You'll need two front legs that are 18" in length and two back legs that begin at 36" long.

To add interest to the chair, cut the top of each leg to a pyramid shape. Set the miter saw to a 5° angle. Place the leg on the saw so that the cut begins about ½" down from the top of the leg. Four cuts are needed to create the pyramid—one at each face. Making the cuts is easy enough, but what might present a problem is aligning each cut with your previous cut.

This is best accomplished by setting a stop-block to position each leg and each cut. Place the leg against the block and make the first cut. Next, rotate the leg one turn and make the second cut. Repeat this pattern for each

face and each leg. There is one set-up for the front legs and another for the back legs. The finished tops appear as small pyramids.

If you can't easily add a stop to your miter saw, you can also mark a line all the way around the top of each leg, ½" down from the top. This will be your cut line.

A chair is not comfortable if the back is straight. I wouldn't want to spend much time sitting with that posture; it's unnatural. So, we need to add angle to the chair. Most times to add angle to the chair you need to bend the back legs. We aren't going to do that.

So how do you create a comfortable angle using straight stock? Easy—tilt the leg. At the miter saw, again with the angle set to 5°, cut the bottom of each back leg. Take off as little material as possible in making this cut. You



Online EXTRAS

For more step photos and a 3-D drawing of the chair, as well as Shaker tape suppliers and instructions on weaving the seat bottom, visit:

popularwoodworking.com/dec07

Be seated. This attractive Mission-style chair can be built using simple tools and home-center oak.

are not looking to shorten the legs, just to create the 5° angle.

Hold That Seat, Please

Any chair's longevity depends on keeping the parts together. A lot of times you can find chairs where the seat is actually holding the parts in place. That is what this chair does.

The seat material is wrapped around dowels that are positioned just above the stretchers and slightly offset from one another. Select

the front face of the chair legs and mark the side and front edges. Locate the position of the holes for these dowels and drill them into the front legs only.

To find the dowel positions, start from the pyramid cut and move down 1 1/2" for the center of the side dowel location. Slide down another 1/2" for the location of the front dowel hole.

Make these holes with a drill and 1" Forstner bit, squaring the bit to the stock from both

directions. Cut the hole about 1/2" deep – it's not critical because you'll take an exact measurement after the chair is assembled.

Assembling the chair starts with the side profile. Lay the legs of one side of the chair on your bench. Orient the pieces so the angle cut on the back leg is parallel to the edge of the bench. Next, cut the rails for the sides. One end of each piece is cut square while the opposite end is cut at that 5° angle. Both cuts are made at the miter saw.

Simple Side Chair

NO.	ITEM	DIMENSIONS (INCHES)			MATERIAL
		T	W	L	
□ 2	Back legs	1 1/2	1 1/2	36	Oak
□ 2	Front legs	1 1/2	1 1/2	18	Oak
□ 1	Front rail	3/4	2 1/2	15	Oak
□ 2	Back splat rails	3/4	2 1/2	15	Oak
□ 1	Back splat	3/4	5 1/2	12	Oak
□ 2	Top side rails	3/4	2 1/2	14	Oak
□ 2	Lower side rails	3/4	2 1/2	13 1/8	Oak
□ 1	Bottom stretcher	3/4	3 1/2	16 1/2	Oak
□ 4	Seat dowels	1" dia.		15	



Angle adds comfort. The rear leg (left) needs only a slight (5°) angle cut on the bottom to add about 50 percent more comfort to your chair.

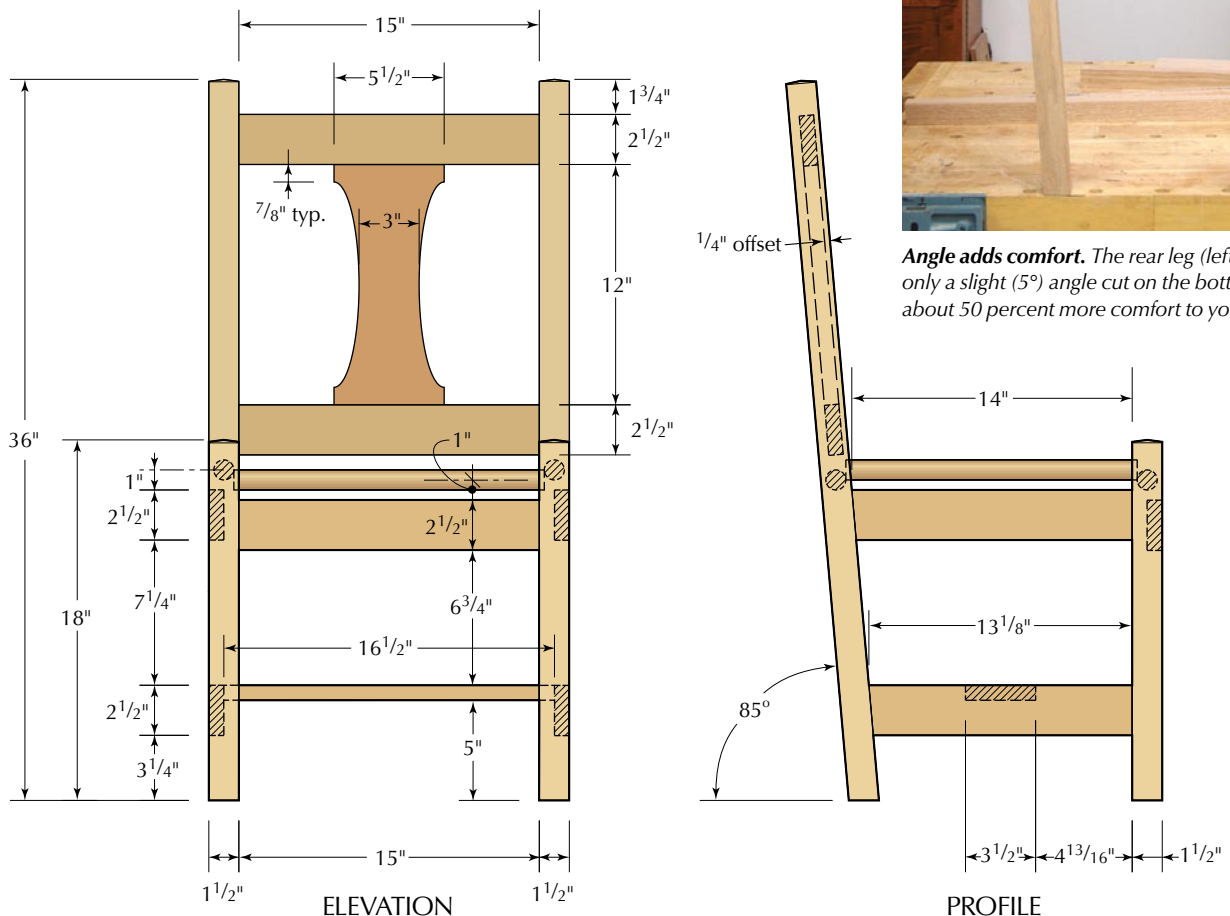

Fit the rails into position with the legs as shown in the top right photo. Notice that the front leg (in the photo at the right) is positioned with the front dowel hole facing upward. The top side rails will fit $\frac{1}{2}$ " below the bottom edge of the side dowel hole, or 1" from its center point.

Position the lower side rail starting $3\frac{1}{4}$ " up from the bottom of the leg. Mark an X at each end of the rails to indicate the area for the pocket screws.

Quick, Strong Connections

Use a drill with the pocket-screw jig to cut the holes in the side rails. Make sure that the ends of the rails fit tightly to the base of the jig; the angled cut will tip the rails to one side.

Place the holes, two per end, about $\frac{3}{4}$ " in from the edges of the rails. Using a framing square will ensure that the chair sides are square to the floor. Position the pieces to the legs as before and make sure that the bottom ends of the legs fit to the square and all faces are tight to the bench. Drive the screws to assemble the sides (don't use glue). Repeat the same steps for the second side, but this



Offset holes. The dowel holes are offset from one another by $\frac{1}{2}$ ". Make sure you've marked the front and left, or right face of each to avoid drilling the wrong hole in the wrong face. The depth of the hole isn't critical, but I tend to drill until the top of the cutting faces reaches the top of the hole. This is usually about $\frac{1}{2}$ " deep with most Forstner bits. To keep the hole perpendicular to the leg face, you can stand a try square next to your drill to give you a true 90° angle to follow.

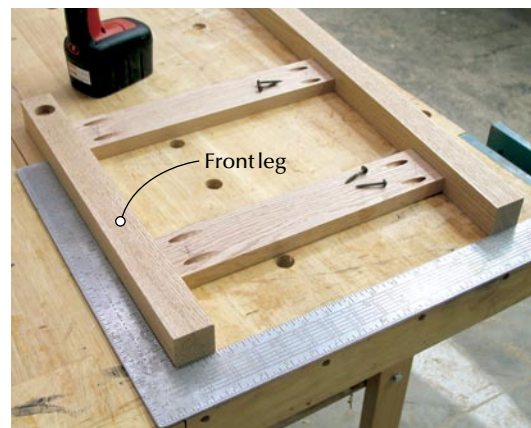

Square assembly. Once the pocket holes are cut, lay the pieces on your bench, square things up and add the screws. Don't use any glue during assembly.

time the chair back or angle must face the opposite direction.

Because the angle of the back is in the side assembly, installing the front rail is a snap. The ends are square-cut straight from the miter saw and the pocket-screw holes are drilled just as they were for the side rails.

Set the side assembly onto the front leg, front-face down to the bench. Position the front rail $\frac{1}{2}$ " below the bottom edge of the dowel hole. Hold the face of the rail flat to the bench and drive the screws to attach the front rail. Repeat the steps to attach the second side assembly to the front rail.



Connecting the sides. With the side assembly sitting on its face on the bench, the front rail is screwed into position $\frac{1}{2}$ " below the dowel hole.

About The 'I Can Do That' Book

Usually, our "I Can Do That" projects fit in two magazine pages, but we've expanded this month's story to feature one of the projects from the new ICDT book, "I Can Do That: Woodworking Projects."



This book (from Popular Woodworking Books), features 17 beginner-friendly (but high-style) projects – some of which you've seen in the magazine, but nine of which are brand new.

The projects in the book require mostly the same basic set of tools you'll find in the free ICDT manual (available at ICanDoThatExtras.com) and mostly the same basic techniques. But as you move through the book, a few new techniques and tools are added, which invites you to move outside of your comfort zone and stretch your skills.

"I Can Do That: Woodworking Projects" (\$19.99) is available at your local bookstore, or direct from the publisher at fwbookstore.com.

Adding a Bit of Design

To add a few shadow lines to the chair back, set the rails by spacing them off of the front edge of the legs. To make it easy, slide a scrap piece of $\frac{1}{4}$ " plywood, or something else of a consistent thickness, under the rails before adding the screws.

You'll find that the chair is starting to gain in weight, so holding the pieces as you assemble the back is a bit of a task. To make it easier, hang the seat portion off the edge of the bench and clamp the top portion of the back leg to your bench. Locate the rails according to the plan, add the spacers under the screw area to create the shadow line and drive the screws to attach the back rails.

Once the chair is assembled you need to take an accurate measurement of the length of the bottom stretcher and fit it to the chair. It doesn't fit between two legs so it will be a different length than the rail.

If you install the stretcher now it will get in the way of other operations, but clamping it in place will add strength for the next step.

The side dowel is installed in a hole in the back leg that is drilled at an angle. That hole is parallel to the side rail and is set $\frac{1}{2}$ " above that rail and centered in the leg.

Chuck the 1" Forstner bit into the drill and set the center point of the bit in position. Drill the hole to a depth of $\frac{1}{2}$ " while remaining parallel to the rail and square to the leg.

Measure the length of the dowels before removing any screws. This measurement is exact for that particular dowel location and can vary depending on the depth you drilled the hole. So, each length needs to be measured. Cut the dowels at the miter saw to guarantee a square end.

There is no possible way to install the dowels in the assembled chair without releasing the hold of the screws. Work one dowel at a time and when the piece is placed in the holes



Add a shadow line. With the front faces of the rear legs clamped to the bench and the lower part of the chair hanging over the edge, it's time to add the back rails. To add some visual interest to the back, I used some scrap wood to hold the rails back from the front edge of the legs as I added the screws.



Align to the stretcher. The dowel holes in the rear legs need to be drilled parallel to the side stretcher, not perpendicular to the rear leg; otherwise they won't fit.



Flushed with clamps. With the splat held flush to the splat rails, the pocket screws are driven home, finishing the assembly of your stylin' chair.

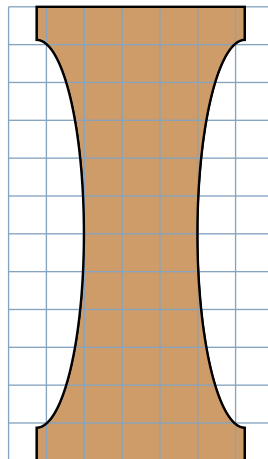

SPLAT PATTERN

reattach the screws before moving to the next dowel. Also remember to install the stretcher at this time.

Another Shot at Design

The chair back splat is another area where you can influence the overall look of the chair. You can design something fantastic or simply leave it straight. I chose a simple arced cut.

To develop any design, first you need to find the length of the splat. This could be determined while installing the back splat rails or just find the measurement at this time.

Don't rely on rulers or measuring tapes for this. You want a snug fit. Lay the chair on its back then square-cut one end of the splat stock. Raise the back off of the bench and slide the splat into position, keeping the square end tight to the lower rail. With a sharp pencil, trace the intersection of the splat with the top rail. This is the exact measurement of the splat.

Make the next cut at the miter saw.

To draw the arcs you'll need a compass that will expand to a radius of $10\frac{3}{4}$ ". That's not your average compass! So, you'll have to make your own. Use a piece of scrap or an older (read as not your everyday ruler) ruler. Drill a small hole at one end of the piece just big enough for a small finish nail. In fact, I often use the nail to "drill" the hole.

Next, move up the piece to the $10\frac{3}{4}$ " line and drill a second hole for the pencil lead to go through. That's your compass – also known as a trammel.

Place a scrap of equal thickness perpendicular to the splat material. Measure down $9\frac{1}{2}$ " from the intersection of the two pieces and place the nail. This is the pivot point of the compass. As you draw the line you will see that the arc starts about an inch from the end of the splat on both sides. Repeat the steps for the second side of the splat and you are ready

to cut those with the jigsaw. Clean up any cut marks with a rasp and sandpaper.

Use pocket screws to connect the splat to the rails. Position clamps over the two back rails, on the face of each piece to keep them aligned as you drive the screws.

Fill any screw holes with the available plugs. This includes all holes in the back and the holes in the side lower rails. Other holes will not be seen once the seat is finished.

To do this, add glue to the hole and tap the plug into place. Allow the glue to dry before sanding smooth.

Adding the Color

The chair is finished with a nice medium-brown stain. Rag on a coat of Olympic Special Walnut stain, allow it to soak for five minutes and then wipe away any excess.

That is followed by a coat of Watco Danish Oil in the walnut tint. This is also allowed to soak for a short time before wiping the chair down. Once the oil dried I elected to spray on a coat of shellac. Shellac can be purchased in a spray can and this allows better control with all the pieces of the chair.

After the shellac has dried, knock down any nubs with #400-grit sandpaper. Add a coat of paste wax.

The final step is to weave the seat. Visit popularwoodworking.com/dec07 for detailed seat-weaving instructions. **PW**

Glen is a senior editor at Popular Woodworking, a published author, the host of the Woodworker's Edge DVD series and teaches woodworking classes and seminars. Contact him at 513-531-2690x1293 or glen.huey@fwpubs.com.

About This Column

Our "I Can Do That" column features projects that can be completed by any woodworker with a modest (but decent) kit of tools in less than two days of shop time, and using raw materials that are available at any home center. We offer a free online manual in PDF format that explains all the tools and shows you how to perform the basic operations in a step-by-step format. You'll learn to rip with a jigsaw, crosscut with a miter saw and drill



straight with the help of our manual.

Visit ICanDoThatExtras.com to download the free manual.

Veritas Small Plow Plane

An important joinery plane is available again – and it's been improved.

Plow planes are workhorse of the hand-tool shop when it comes to cutting joints with a plane. With a plow plane you can, if you are so inclined, cut many of the important joints for a carcass: rabbets, grooves and even tongues.

Before electric power tools became affordable, plow planes were even a status symbol among craftsmen. If there was one fancy tool with ivory inlay and nickel silver tips in your chest, it was your plow.

Since World War II, plow planes have all but vanished from tool catalogs – their functions being taken up by routers and table saws. But now Veritas, the manufacturing arm of Lee Valley Tools, has revived this important



Veritas Small Plow Plane

Lee Valley Tools ■ 800-871-8158 or leevalley.com

Street price ■ \$199

For more information, circle #164 on Free Information Card.

form. And I think that anyone who gives this tool a try will get hooked on how easy it is to use, how crisp the results are and how fast you can make simple joints.

The Veritas version of this tool improves on many of the details of the old tools (both the metal and wooden versions) that have vexed woodworkers for generations. Let's start with the fence, which is the heart of the plow.

To make a straight groove, the fence must be locked parallel to the skate – the thin rail of iron that's the plane's sole. All vintage plows I've worked with require fussing to get the fence parallel. The Veritas makes it almost impossible to skew the fence, and you can thank router technology for that. Veritas uses, in essence, router collets to lock the fence in place. And the collets work quite well.

Another improvement is the fence itself. Wooden plows eject shavings onto the bench (nice). But vintage metal plows eject them into your fence and hand. This means that you have to clear that trap every few passes. Veritas improved the way shavings eject. And though it's not a jam-free set-up, you do have to clear the tool of curls far less than usual.

The third major improvement is in the controls themselves. Everything adjusts through knurled knobs – no tools are required. Metal plows require at least one screwdriver. Wooden plows require a mallet to adjust.

The Veritas comes with a 1/4" cutter (the most useful size) in durable A2 steel. Four other sizes are available from 1/8" to 3/8". The plane body is lightweight at 1 lb. 14 oz. and is made from unbreakable ductile iron.

In use, I found the tool superior to my old plows. Everything locks with hand pressure, and the tool balances on the work. The fence has a large bearing surface so you can keep it firmly against your work, a critical point (and the fence is bored to accept a longer wooden fence if you require it). The workmanship on the tool is top-notch.

Here's the best part: This is the Veritas Small Plow. With a name like that, you have to think that other versions are on the way.

—Christopher Schwarz



Made for joinery. Here you can see how the fence is relieved so you can close it up to cut rabbets. Also note the slight curved shape of the depth stop. This prevents the stop from ramming into your work.

Apollo's Atomizer: A Tale of Two Types

An investment in a new tool can increase your woodworking abilities; an investment in HVLV will do the same. If you spray your finish, you know already what I'm talking about. If you haven't ventured into spray finishing, it's time. Great results are so much easier to achieve that you'll never look back.

Apollo Sprayer International Inc. makes the investment easy with the 7500 Series Atomizer spray gun. The standout feature of this gun is that it's used with either a turbine — any turbine, from any manufacturer — as a standard HVLV system or as a conversion gun when you attach compressed air. And your compressor size is not an issue. All that's required is a minimum 3-horsepower, 20-gallon tank. With either method you have a superb performing spray gun.

The Atomizer is a multi-use, multi-purpose spray gun that allows the user to choose from three different methods of operation. Use the gun as a gravity-feed unit (cup above the handle), in a standard arrangement (cup under the handle) as we did, or as a production gun feeding fluid directly from the source.

Another feature of the 7500 Series Atomizer is that you adjust the fan of the spray

pattern by dialing a ring located just behind the nozzle. Adjusting the fan spray makes finishing small objects or working in tight areas easier.

Included with the Atomizer is an all-purpose 1 mm tip and needle. While other tips are available, I used that setup for spraying thinned lacquer, thinned shellac and water-base aniline dyes and my results were better than expected. This covers most woodworking project finishes.

Worried about cleaning the gun? Don't be. There are no "O" rings in this gun; clean up is as easy as a thorough rinsing then wiping of the basic parts. And the coated interior of the cup eliminates aluminum-related finish issues, especially with shellac.



Atomizer

Apollo Sprayer 888-900-4857 or hvlv.com

Street price ■ \$349 (spray gun only)

For more information, circle #165 on Free Information Card.

Mallet Takes (and Gives) a Good Beating

For more than a decade, I've meant to make a good wooden mallet that fits my hand and my style of work. I can now cross that off my "to-do" list thanks to a new mallet from a Pennsylvania company that does a great job of hitting both chisels and all my hot-button issues.

For starters, it looks like a traditional mallet you'd find in a catalog, but this one has been soaked for many weeks in linseed oil. The soaking adds significant weight, without having to increase the size of the mallet's head.

The mallet is 13" long overall with a 2³/₈" x 4⁵/₈" head. So it's a nice small size — you're not going to smack yourself in the head and you can get into fairly tight places.

The mallet I tried is listed as approximately 22 oz., but mine weighs 19 oz., according to our postal scale. That weight offers plenty of punch for mortising hardwoods or chopping out the waste between dovetails. Lighter-weight mallets make my forearm sore and require more effort than necessary. Smaller and larger sizes of mallets are available from the manufacturer.

Other touches to the tool are strictly traditional. All the correct edges are chamfered (I like chamfers), and there's a nice leather wrist strap. This strap is great for hanging the mallet over the bench or keeping it on your wrist should your palm become separated from the handle during a wild swing.

I like this mallet. And so does Senior Editor Glen D. Huey, who chopped out about 100 dovetails for the cabinet base on his workbench with it. The mallet packs a ton of punch for its size and is a good fit in your hand. The mallet comes in four sizes between 18 oz. (\$22.95) up to 32 oz. (\$29.95). The 22 oz. model we tested is \$24.95.

Some woodworkers might scoff at pur-



Carpenter's Mallet

Di Legno ■ 877-208-4298 or DLWS.com

Street price ■ \$24.95

For more information, circle #166 on Free Information Card.

chasing a tool they could make themselves. However, making a mallet that looks correct is harder than making a mallet that works well. This one handles both tasks. **PW** — **CS**

Poppy Table

BY ROBERT W. LANG



Before developing the rectilinear Craftsman style, Gustav Stickley experimented with curvaceous Art Nouveau designs.

Fresh look from an old design. This small tea table was originally made more than 100 years ago by Gustav Stickley. His sense of proportion and design was not limited to straight lines.

In 1898, Gustav Stickley took a working vacation. With more than 20 years of experience as a furniture maker, he was ready to change direction, and he headed across the Atlantic Ocean for inspiration. The Arts & Crafts movement was strong in England, while in France the latest thing was L'Art Nouveau.

In 1900 Stickley debuted several new designs marketed as “New Furniture” by the Tobey company of Chicago. This table was one of the most striking of those pieces, heavily influenced by Art Nouveau and a far cry from the rectilinear designs of the Craftsman style furniture he would become best known for.

There is a hint of things to come, however. The edges of the top, shelf and legs are all sinuous curves, but the surfaces are essentially flat, and the corners are just barely broken. It also presents an interesting engineering problem. Beneath the carved surfaces and waving edges, the table is based on a pentagon, so the angles between the stretchers, shelf and five legs are at 72°, not 90°.

This “Poppy Table” has been on my to-do list for a long time, and when I came across some good photos from an auction, I decided that the time was right to go ahead.

Engineering First

When I began working on the design, my first concern was the shape of the pieces. I soon realized that this project would also be a structural challenge. In the original, face-grain plugs are visible on the outside of the legs, centered on the shelf. Usually this means a screw is beneath the plug, but it seemed to me that these joints needed more than a mechanical fastener.

I don't really know how the original is held together at the intersection of the leg and shelf. Loose tenons seem the obvious solution to us today, but at the time a dowel or two flanking the screw would have been more likely. I decided to use Festool Dominos for loose tenons, along with a screw to pull the assembly together. It's hard to clamp a pentagon.

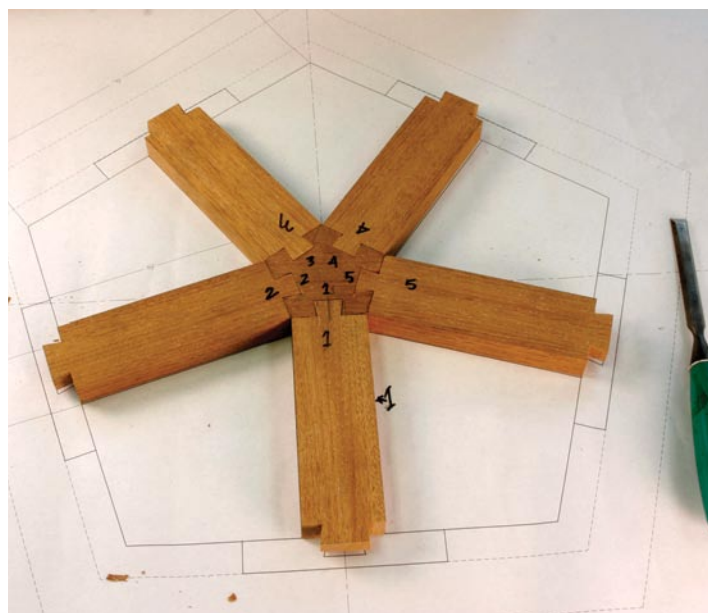

Following the plan. A full-size layout aids in making the parts and the joints accurately. As the table was assembled, I compared the actual pieces to the lines on the drawing.

At the top of the legs, stretchers seemed necessary, but it was a puzzle deciding how to connect them to the legs. There isn't any structure visible in the photo I was working from, so my solution is a best guess. I used a lapped dovetail at each end of the 2"-wide stretchers, and in the center made a five-sided hub piece that holds them all together.

Together Twice to Make it Nice

All the parts for this table came from a single plank of mahogany about 14" wide and 12' long. I made all the joints and dry-assembled the entire table before doing any of the decorative work.

The hub is the piece I worried most about. It is like a keystone that affects the location of the other joints. Any variations in this piece and the legs would twist and throw off the joints at the shelf. Because it was too small to safely cut on the table saw or miter saw, I cut it on the band saw. I then made a small shooting board, shown in the photo below, and trimmed the hub to size with a low-angle block plane.

I made a full-size printout of my drawing (you can purchase one for download online at popularwoodworking.com/dec07 for \$3, or create one yourself using the scale drawings on page 39) and used that to check the parts



The hub is the keystone. All of the structural parts of the table radiate from this small piece, so it needs to be precise. This shooting jig lets me trim it down in tiny increments.



Hidden lapped dovetails. The stretchers connect to the hub and the leg with 1/2"-thick lapped dovetails. They are 3/4" wide at the hub end and 1" wide at the leg.



Never to be seen. These joints won't show in the finished table, but they must be strong. The sockets in the legs were wasted with a small router; the sockets in the hub with wasted with a Forstner bit. I then pared them all to size with a chisel.

and assemblies as I made them. I cut a rabbet at each end of the stretchers with a tenoning jig on the table saw, leaving $\frac{1}{2}$ " thickness for the dovetails. I hand cut the dovetails and used them to lay out the sockets in the hub and the top of each leg. Numbering each stretcher and its hub location helped keep the parts in order.

Because the hub was so small, I couldn't use a router to remove the waste for the sockets, so I used a Forstner bit at the drill press to establish the flat bottom of the sockets and cleaned up the sides with a chisel. For the sockets in the legs, at the other end of the stretchers, I used a $\frac{1}{4}$ " spiral upcut bit in a small router with a fence to cut a smooth bottom and back for each socket. Again, I cleaned up the corners with a chisel.

Then I dry-fit the hub to the stretchers, and test-fit the assembled hub and stretchers to the legs. After a bit of tweaking to the joints, I glued the stretchers to the hub, but left the stretcher-to-leg joints loose.

I cut the shelf to size, and made sure that it fit the perimeter of the legs and assembled top hub. I centered a Domino in each edge of the shelf at the maximum depth and at the center of each leg at the minimum depth, with the top of the shelf $7\frac{1}{8}$ " above the bottom of the leg. I glued the Dominos into the shelf only, drilled a counterbored hole and drove a #8 x $1\frac{1}{2}$ " screw through each leg and into the tenons in the shelf.



Straight fitting. All the joints were made and all parts dry-assembled before doing any of the shaping to the legs and shelf.

After squaring up the shelf and legs, I was ready to cut the parts to final shape. When I was satisfied that everything was tight and square, I took it apart to cut the profiles.

The Shape of Things

I used spray adhesive to glue full-size paper patterns to the blanks for the shelf and top. I also glued a full-size pattern to a piece of $\frac{1}{2}$ " Baltic birch plywood to make a template for the legs. The top and shelf were cut to shape at the band saw. Where the shelf meets the legs, I left a flat area in the curve for the joint. I ended the curves about $\frac{1}{2}$ " away from the intersections with the legs so I could trim right to the meeting point after the legs were shaped and smoothed.

The plywood pattern I made for the legs has the pattern on only one side. After cutting the pattern just outside the lines on the band saw, I smoothed the plywood edges back to the lines with a rasp.

I marked one side of each leg, then flipped the pattern over to mirror the outline on the vertical centerline. This saved some time in making the pattern, and it ensured that the legs would be symmetrical.



Rapid layout. Gluing a full-size paper pattern to the shelf blank eliminates transferring the pattern. The paper will stay in place through the cutting process.



Taking a stab at marking. Cutting through the pattern with the point of a knife establishes the layout lines for the carving.

After cutting the outside shape of the legs at the band saw, I drilled holes near the ends of the cutouts, and I used a jigsaw with a narrow blade to rough-cut the shapes. I clamped the pattern to the legs, then trimmed the outside edges and the cutouts with a $\frac{1}{4}$ "-diameter flush-cutting bit in a small router.

Stickley Poppy Table

NO.	ITEM	DIMENSIONS (INCHES)			MATERIAL	COMMENTS
		T	W	L		
❑ 1	Top	13/16	21 ³ / ₁₆	22 ⁵ / ₁₆	Mahogany	
❑ 1	Shelf	13/16	16 ¹ / ₁₆	16 ⁷ / ₈	Mahogany	
❑ 5	Legs	13/16	4 ⁷ / ₈	22 ¹¹ / ₁₆	Mahogany	
❑ 1	Hub	13/16	3 ¹ / ₁₆	3 ¹ / ₄	Mahogany	
❑ 5	Stretchers	13/16	2	6 ¹³ / ₁₆	Mahogany	1/2" dovetail both ends

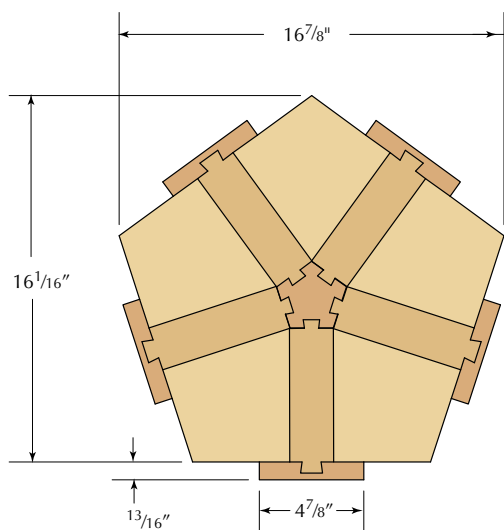

PLAN BELOW TOP

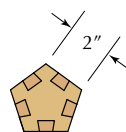

HUB PLAN

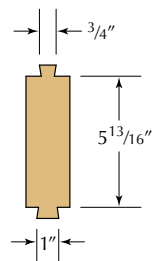

STRETCHER

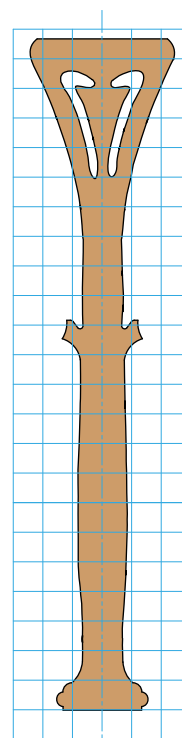

1 Square = 1"

LEG PATTERN

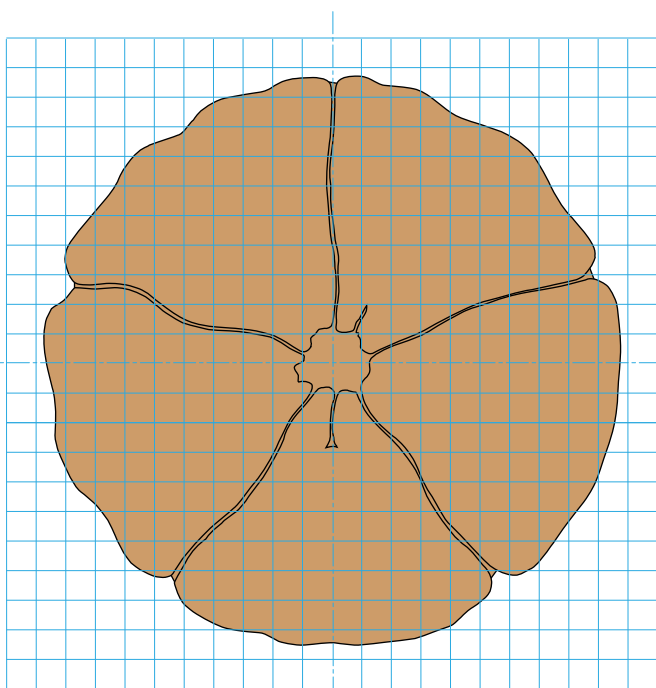

1 Square = 1"

TOP PATTERN

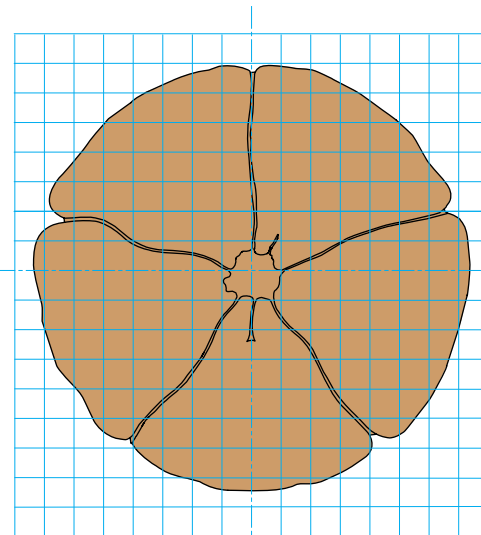

1 Square = 1"

SHELF PATTERN

Online EXTRAS

For additional photos and text, and to purchase full-size patterns in pdf format, go to:
popularwoodworking.com/dec07

A Little Carving

Before removing the paper pattern from the top and shelf, I traced the lines of the carving with the sharp point of my knife. After darkening these thin lines with a pencil, I used a 60° V-tool to establish the depth and sides of the lines. I followed that with a 1/8"-wide #11 gouge. The profile of the lines is mainly the profile of the U-shaped tool, so the only real challenge in carving was getting smooth, consistent lines.



Shape from the tool. After starting the carving with a V-tool, a deep, narrow gouge cleans up the cuts and defines the profile of the lines.

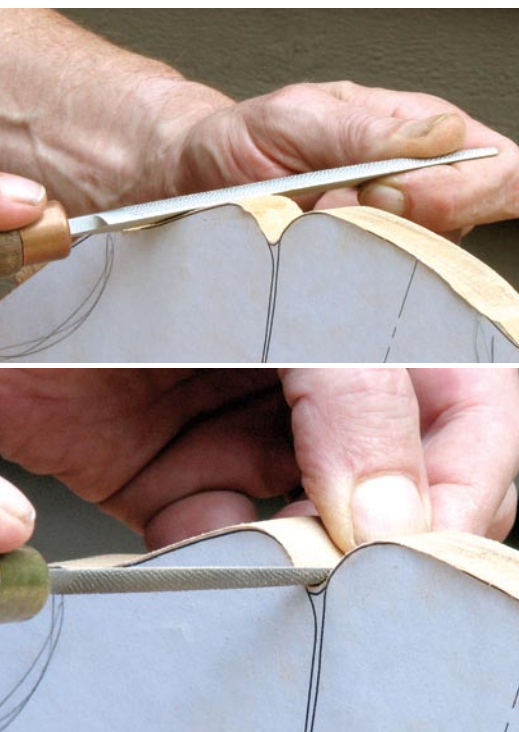

Rasp to the rescue. The flat side of this rasp removes the band-saw marks on most of the edge. The round side gets into places the flat side can't reach. Many of the finished tight curves are defined by the shape of the tool.

The lines that define the lobes were rounded slightly at the top with a skew chisel. The central portion of the carving is slightly domed. This is the only portion of the top surface that isn't flat. After carving, I smoothed the flat surfaces of the top with a plane, following up with a scraper and #240-grit Abranet (a new abrasive on a flexible mesh-like base that's not paper. Abranet cuts fast, leaves a smooth surface and doesn't load up).

Living on the Edge

The band-saw marks on the edges of the top and shelf were removed with a rasp. The edges were further refined with a modeler's rasp. One of the good things about using a hand-stitched rasp is that the surface left by the tool is a series of tiny grooves. A cabinet scraper quickly removes the high spots between the grooves, leaving a smooth surface.

The corners were broken with a few strokes of the fine-cut modeler's rasp, followed by sanding with a small piece of Abranet, folded to make a slight radius. When the top and shelf were complete, it was time to move on to the edges of the legs.

Another advantage to using the rasp is the ability to use the half-round side to shape inside curves as seen in the photo below at left. Many of the curves on this piece closely matched the curve of the rasps, so I believe that the original maker likely used the same technique and tools.

I used the same procedure and sequence of tools to smooth the edges of the legs and the cutouts at the top of each leg. The router bit left a decent surface, but there were a few chatter marks on long surfaces, and some burning in the tight inside corners. I wanted these edges to be as nice as the flat surfaces so I planned on it taking awhile.

Actually it took quite awhile. Smoothing the edges of the legs took about half the time I spent on this entire project. What slowed this step down were the tight corners at the buds on the legs, plus the cutout areas. In these places, the grain direction of the mahogany changes from long grain to end grain and then back again in the span of a few inches.

No one area was difficult to smooth, but the number of curves increased the overall length of the perimeter, and each area required a different approach. I found a stool to sit on, and settled in to get it right. When I was satisfied with the rasping and scraping, I went over the entire table with Abranet to obtain a consistent, smooth surface.



A close scrape. The hand-stitched rasp will leave shallow, narrow grooves. A cabinet scraper follows the rasp to remove the high spots between the grooves and leaves a fine surface.

Together at Last

I made one final dry assembly, screwed the legs to the shelf, then tapped the top stretchers into the tops of the legs. I marked the intersections of the shelf and legs, and carefully carved the shelf edges down to these points.

The final assembly was quick and painless. With screws holding the legs to the shelf, and the dovetails at the top of the legs, I didn't need any clamps. After applying glue to the end grain of the mortises in the legs, I applied glue to the tenon ends in the shelf, put the legs in place then drove the screws.

After making sure the legs were square to the shelf, I applied glue to the sockets at the top of the legs, then pushed and tapped the stretchers into place. Finally, the screw holes were filled with 3/8"-diameter mahogany plugs. After the glue in the plug holes was dry, I pared the plugs flush with the face of the leg using a 3/4" chisel. I then went over the face of each leg with my scraper and Abranet.

At the center of each stretcher, I drilled a 3/16"-diameter hole, and with the tabletop upside down on my bench, I lined up the assembled table base with the top. Each of the legs is centered in a lobe of the top, and the grain and pattern of the top is aligned with the shelf. In each of the five holes I drove a #8 x 1 1/4" washer-head screw. The holes are larger than the shanks of the screws, allowing the top to expand and contract.

I've seen original versions of this table in both mahogany and oak. Mahogany is a



Final cut. After shaping the legs and the shelf, the intersection is blended with a #1 straight carving chisel. Leaving these small areas oversized until almost the end of the project resulted in crisp detail in a highly visible place.

beautiful wood, and I wanted a finish that would show it off without filling the grain or looking polished. I used dark walnut Watco Danish oil for the first two coats and natural Watco Danish oil for the final three.

I applied the oil liberally, let it soak in for about 15 minutes, then reapplied more oil. I wet-sanded the table with a Scotch-Brite pad on the first coat, let it sit for another 10 minutes then wiped the surface dry. I waited a day between coats, then saturated the surface, allowed the oil to sit for 15 minutes, then wiped the surfaces dry.

Gustav Stickley's talent as a designer is often downplayed by those who aren't familiar with his entire career. The straight lines and masculine proportions of his Craftsman furniture can lead a person to believe that his entire body of work contains no curves or delicate shapes.

The Poppy Table was one of three similar tea tables produced in 1900. All three are exquisitely proportioned, sensitive designs based on floral forms. The style can be seen as a bridge between Art Nouveau and American Arts & Crafts. These early gems show that Gustav Stickley's tremendous talent for design was not dependent on the direction it was focused. **PW**

Bob is the author of several books about furniture from the Arts & Crafts period, including "Shop Drawings for Craftsman Furniture" (Fox Chapel). More information is available at his web site: craftsmanplans.com. Contact Bob by calling 513-531-2690 ext. 1327 or e-mail: robert.lang@fwpubs.com.



It isn't cheating. The original table had face-grain plugs in the faces of the legs. It is reasonable to assume that there are screws beneath the plugs. A Domino loose tenon reinforces these joints.



Last tap. The assembled hub and stretchers fit into the dovetail sockets at the top of the legs. When everything is lined up, they are tapped home, completing the assembly without using clamps.



First coat. Dark walnut Danish oil helps to accentuate the grain of the mahogany. Two color coats were followed by three coats of natural Danish oil.

Practical Safety Devices

by Marc Adams

I recently ran into an old woodworking friend of mine who had his hand all bandaged up, and the first thing he told me was: “I have new respect for my router table.”

He went on to say that he was doing something that he knew was dangerous, had done it before and was sure he could get away with it again. The workpiece was definitely too short and sure enough it caught and pulled his hand into the cutter. The first thing I asked him was, “Were you using a push stick and was the guard in place?”

His head sank while his eyes looked at the top of his shoes and he uttered an embarrassed “no.” He knew better and he was going to pay the price with a scar for the rest of his life. And even though his fingers were mauled and sore, he knew the accident could have been much, much worse. Throughout

Keep your guard up. To be safe in the shop, you need three things: guards that work, practical safety devices to assist your cuts and good rules to work by.



PHOTOS BY AL PARRISH

A Better Way to Work • Part 2

WOODWORKING Essentials

the years I have probably heard as many woodworking horror stories as anyone, and I have always found the explanations of what happened to start off one of two ways. Either: "I was doing something stupid," or "It was late and I had just one more cut." But I have never, ever had someone tell me that their accident happened because of a properly working guard, or because of a properly functioning safety device or apparatus, or because of proper techniques. But sometimes accidents happen because the user simply chooses the wrong machine. For example, when trying to cut a 1" x 1" block of wood in half, the power miter box would be the wrong machine; a scrollsaw or a fine hand dovetail saw would be a much better and safer choice.

Remember the 12" and 3" rule from the first chapter of this series. If the work is shorter than 12", ask yourself if that piece is too small for the capacity of the machine you have chosen. And you should always follow the 3" rule, which causes you to set a boundary limit of hand clearance of 3" or more away from any guard, shield, pulley or pinch point.

Machines used in woodworking can be dangerous, particularly when being used improperly or without proper safeguards. Often, machines are asked to do a variety of tasks. Sometimes these tasks are within the limitations

of the machine and sometimes they are not. More than likely, when a machine is being asked to do something complicated, such as cutting cove moulding on a table saw, or cutting very small pieces on the band saw, the standard guard will not work and might even make the process more dangerous.

However, it is important that you provide additional safety devices such as guarding and push sticks to establish control and to protect yourself. Guards, whether the original to the machine or homemade, play an enormous role in safety and should always be considered before any cut is made. OSHA explains guards this way: "A guard should prevent employees from contacting the dangerous parts of the machines, and it should be secure. Workers should not be able to easily bypass, remove or otherwise tamper with the guard. In protecting the worker, however, the guard must not create additional hazards, nor prevent the worker from performing the job."

Although OSHA rules do not apply to hobbyists or the one-man shop, they do set practical and reasonable standards that everyone should follow.

Point of Operation

The point of operation is the place where work is performed on the material. This is where the stock is



Two more layers of protection. The clear Lexan shield on this cut-off sled is durable and does not restrict your line of sight. The block of wood at the end of the shield covers the blade at the end of the cut, making this jig quite safe.

cut, shaped, bored or formed. Most woodworking machines use a cutting or shearing action that is produced by rotation or reciprocation. These actions, when under power, are dangerous regardless of the speed, size or surface of the moving parts. It is at this point that considerations have to be taken to guard or protect the user from accidental contact.

There are two aspects to consider when it comes to safeguarding machines at the point of operation. The first is to use some type of guard to help cover the cutter and prevent physical contact with the dangerous part of the machine. The second safeguard is to set shop standards such as the 3" rule. It is important when setting boundaries of awareness such as the 3" rule to understand when to use safety devices such as push sticks, push blocks, featherboards, combs and special aids to assist in feeding stock through the process.

Types of Machine Guards

There are three types of guards that are used on woodworking machines: fixed, adjustable and self-adjusting.



Spring-type guard. The beauty of this shop-made device is that it performs two essential functions on a router table: It holds the work down and denies your fingers access to the spinning cutters.

Fixed guards provide a permanent barrier on a part of a machine. Usually fixed guards are used to cover pulleys and belts, cutterheads on a planer and protect the on/off switch from being accidentally activated. These types of guards require little to no maintenance and provide maximum protection.

Adjustable guards provide a barrier that may be adjusted to facilitate a variety of operations. These guards are set by the operator before the cut is made and they maintain that setting throughout the cut. There are a few downsides to adjustable guards in that they don't stop your hands from entering the danger zone and that they can also limit visibility.

Self-adjusting guards provide a barrier that moves according to the size of the stock entering the point of operation. A self-adjusting guard stays in place when the machine is at rest then adjusts for the wood while the cut is being made. These are the types of guards found on most all woodworking tools such as table saws, jointers and power miter boxes. These guards can require frequent maintenance and they can limit visibility.

Remember: An important part of woodshop safety is that you must guarantee safety for two – you and the machine. It is therefore important to understand the choices you have in deciding which guards will work best. There are three options. The first is to use the standard guards that come with the machine without any alteration. However, there are times when those guards can be cumbersome, difficult to work around or just plain in the way.

The second way to safeguard a machine is to purchase one of the great aftermarket guard systems such as the Biesemeyer, Excalibur or the Brett-guard. (I have always used the Biesemeyer table-saw guard with both the splitter and overhead shield, and have been very happy with its effectiveness on my table saws.)

The third way is to make your own guard or shield. Yes it's perfectly legal to make your own safety guard in your shop. Remember: OSHA does not regulate the individual homeowner's shop. With any homemade guard, it must be well engineered, securely fixed



Hooks and protects. *The hook at the end of this push stick protects your thumbs from a common injury on the jointer; plus, it changes the vector of the forces applied to the board to give you more control during the cut.*

in position and allow safe operation of the equipment. If you have employees using this equipment, then OSHA rules apply and they require that guards be designed and installed by technically competent and qualified persons. OSHA might also require that the manufacturer of the equipment review the proposed guard design to ensure that the guard will adequately protect your employees.

Making Guards

I recommend that guards and shields be made out of the best material you have available. That might include solid wood, such as the spring-type guard and hold-down, or the wooden block to protect the user from the blades after the cut has been made that are shown on page 44. Baltic birch, MDF and particleboard are all good guarding materials except they can restrict your vision. I recommend you drill a few holes to allow a little peek into what's happening at the point of contact.

The last and probably the best material to use whenever possible is Lexan, a polycarbonate plastic made by General Electric. It is said to be 200 times stronger than Plexiglas. It is worked easily by the band saw, table saw and drill press. It is a bit expensive so I recommend that you buy it as scrap or off-fall from your local plastic dealer. Because Lexan is a polycarbonate material, it can be glued together, but I suggest that you ask your plastic dealer which adhesives

he recommends. It's possible to order a two-part adhesive specially formulated for polycarbonates that is made by IPS Corp. The product is a high-strength clear polyurethane glue called Weld-On 55.

Push Sticks and Other Safety Devices

Push sticks are the ultimate sacrificial tool. If you have one that doesn't have at least one nick or cut in it, then you aren't using it enough. They are used on table saws, band saws, jointers, router tables and shapers to push short or narrow lengths of material through the cut. Some push from behind the work, some hold and push from the center of the work, some are very thin, some are made of plastic and some will be forfeited to make a very specific cut. They are always replaceable. Push sticks are valuable tools regardless of their shapes and sizes. However, there are specific ways to use them and some push sticks are better for certain cuts than others.

It is important to understand when to and when not to use a push stick. As long as you have your hands on a board when making a cut, you will always have a great degree of control. As soon as you use a push stick, you lose a great degree of that control. I would always recommend that you choose to use your hands for pushing your work when you have more than a 3" clearance from the guard – you simply have more control.

However if your hands will be within 3" of the guard then a push stick



Twice as pushy. Good push sticks for the router table can be used vertically or horizontally on the table. Note how the hook helps push the work through the cut with no danger to your fingers.

is definitely necessary. Again, be aware that you will lose some control. Push sticks should not be used at the beginning of a cut on a long board – your hands have more control and will not be at risk. I keep my push stick handy, and when my push hand gets to that 3" limit, with one hand holding the board firmly, I let the other hand pick up the push stick and finish the cut.

There is one catch to push sticks. We've all seen the old-style push sticks – you know the kind you had in high school shop class that look a bit like a snake with an open mouth. Well, those are the ones I would use as a second choice. These types of push sticks have a pushing vector that is almost straight down at the back of the board. With too much pressure applied at the wrong time it could cause your board to tip upward. However it is always a good idea to have a variety of different styles of push sticks available. Here are my recommendations for making a first-class push stick, which works more like a push block.

1. You can make push sticks out of any scrap material in the shop, however Baltic birch would be the best choice because it has great internal structure, is rigid and can bear a great pushing load. Particleboard and MDF would be lesser choices because they have no internal structure and can fracture easily. Still, if

particleboard or MDF are all you have, they will make acceptable push sticks.

2. Never make a push stick with a handle grip (similar to a handsaw grip). Although this seems like a good idea, it can cause your hand to be trapped, and if for some reason the push stick gets grabbed or thrown, your hand will be caught and could be seriously injured.

3. Push sticks should always be thinner than the width of wood being cut. If the push stick is too wide, it will not clear between the guard and the fence. It is a good idea to make several push sticks of varying thicknesses.

4. Push sticks should be designed to hook the back of the board, however, I think it is very important to have the push stick also sit on top of the wood. This will change the vector of push from the back of the board to on top of the board and will greatly improve the amount of control. Again, it would be a good idea to have push sticks of varying lengths for different-sized work.

5. Good push sticks that sit on top of the board (such as the one for the router table pictured above) can be used both on the vertical and horizontal, which make them very handy.



Wrong and right. The push blocks that came with your jointer are useful if you use them correctly. Don't grasp the handle as shown above left. This traps your hands. Instead, wrap your hand over the push block as shown at right. Don't forget to replace the pad's foam with a piece of sandpaper.

6. Be aware that sometimes push sticks can slip off of your work causing a very dangerous situation. Always keep your push stick hooked firmly over the edge or side of your work.

Push Blocks

Push blocks are very similar to push sticks but they permit you to apply considerably more forward pressure throughout the cut. There are two types of push blocks. One simply sits flat on the top of the board; the other sits on top of the board but also hooks over the back. One of the big struggles we all have with push blocks that don't hook over the back of the board is that they can have a tendency to slip. I recommend that you take a piece of sticky sandpaper and attach it to the bottom of your push blocks (replace the foam). This will give the push block more grip and less slip.

I think it is important to understand the correct way to use push blocks with handle-type grips because your hand can become trapped if you grab through the handle. Unfortunately, all the plastic push blocks have this type of grip. The grip also is at an angle to allow the pushing vector to force the wood to move in a specific direction. I recommend that you hold this type of push block with your fingers over the top of the handle in order to avoid being trapped. It is also important to make sure that the angle of the handle grip is forcing the work against the fence or in the direction you wish the force to be directed.

When using the table saw to cut thin stock, I prefer to use a push block that straddles the fence. This will give the push block more control.

Hold-downs and Restraints

Featherboards, spring boards, combs, anti-kickback fingers, spreaders and magnetic hold-downs are all methods to hold the work down or against an edge. Shopmade featherboards and combs should be made out of solid wood. They are usually cut on one end at an angle of about 45°, with slots cut in the same end to make the board somewhat flexible. These do a great job of providing side or top-down pressure with resistance to the wood being



Helpful featherboards. Here I'm employing two featherboards to keep the work under control. Note the additional brace in front of the featherboard that's flat on the router table.

thrown backward toward the operator (similar to anti-kickback fingers). It is important that featherboards, combs and magnetic hold-downs not be placed to create side pressure behind the blade for ripping on a table saw or band saw. If one of these devices is placed toward the back of the blade it will cause a binding that could result in the start of a kickback. Sometimes featherboards are asked to hold down and push in at the same time. This can easily be accomplished in one of two ways.

The first is to simply use two featherboards: one in the horizontal position and one in the vertical position. A second option might be to use a featherboard that is cut from thick material. It can be made like a regular featherboard with the exception that on the 45° leading edge, you cut a bevel that will help push and hold down the stock at the same time. There are sometimes challenges to overcome with clamping featherboards to your cast-iron tables. If a simple clamping solution is not readily available, you might try placing high-strength, fiber-woven carpet tape on the down side. This will hold the featherboard to the table but will not quite give the “stay put” holding power that you can get with a screw or clamp.

Use Stops for Safely Reproducing Production Cuts

Stops for production cutting or cutting duplicate parts can be set up on just

about every machine except the planer. The requirements for stops vary from machine to machine and depend on the actions that are taking place at the point of operation. Stops are most commonly used for three purposes. The first is for repetitively cutting wood to a consistent length. The second is for acting as a control during a start cut where the wood is engaged in the center of the board. The third way is to prevent wood from kicking back during operations. The resulting action of the cut will determine how the stops are to be placed and how they are to be used.

There are very specific rules for stops. For example, using the fence on a table saw as a stop for crosscutting could be very dangerous if done improperly, while using a stop on the fence of a jointer might be perfectly fine. Because there is an infinite number of stops and ways they can be set up and used, it is better to have some simple safety guidelines to follow with their application. Keep in mind that placement of all stops might depend on whether the cut is made across the grain or with the grain.

1. Stops must be set up to create no binding whatsoever. They must not interfere with any guards or safety apparatus and should not restrict the user from safe operations.

2. Never crosscut on a table saw when using the miter gauge and fence at the same time. The cut-off work can be captured and twisted between



Proper crosscutting. Don't use the rip fence as a stop block for crosscutting. The better way to make repetitive crosscuts on a table saw is with a sled and a double-clamped stop block.



Clamp it twice. A loose stop block will spoil your accuracy and cause you to lose control of your cut. Whenever possible, use two clamps on your stop blocks, such as this stop on my miter saw's fence.

the fence and blade and can be thrown back toward the user. This will create a dangerous kickback.

3. When stops are used, the wood captured between the stop and the blade must be held securely. For example, on a chop saw the wood between the stop and the blade must be held firm and still until the blade comes to a complete stop in the down position.

4. Be aware of the rotation of cutters, bits or blades when choosing the location of a stop. For example, whenever using stops on the drill press, you need to remember that the chuck spins in a clockwise direction so the pulling or kicking force will be in that same direction.

5. Whenever possible, stops should

be double-clamped into place to prevent movement of the stop and to make sure it doesn't come loose during operations.

6. Stops must be designed so that sawdust does not build up and interfere with the accurate or safe use of the stop.

7. Stops can also be used to prevent wood from being kicked back, such as the stops used on a jointer when cutting tapered legs. These types of stops must always be tight and can be used as a way to prevent kickback when the cutter fully engages the wood. **PW**

Marc Adams is the founder of the Marc Adams School of Woodworking in Franklin, Ind., one of the largest woodworking schools in the world. For details, visit marcadams.com or call 317-535-4013.

Work with More Accuracy (and Safety) in your Woodshop

The best way to use your machines is rarely explained in the manual. Find out how to operate machines to get accurate results without sacrificing safety.

• Part 2 Practical Safety Devices

Choose the right guards, push sticks and hold-downs to work safely.



IN FUTURE ISSUES

• Part 3 Power Jointers

Most people use their jointers incorrectly, resulting in warped stock and unsafe operations.



• Part 4 Miter Saw

Stock miter saws are neither accurate or safe. Here's how to fix both problems.

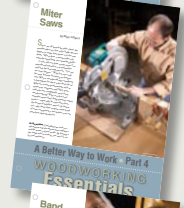

• Part 5 Band Saws

Band saws are safe if used correctly; however it's easy to step over the line and get bit.

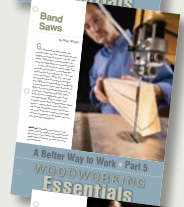

• Part 6 Planers

Powered planers seem like safe machines until you start testing their limits.



• Part 7 Table Saws

The fundamental skills to get good (and safe) results with the most important woodworking machine.

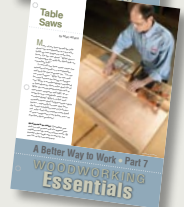

IN PAST ISSUES

• Part 1 Learn the Skills to be Safe

The groundwork for a lifetime of accurate woodworking is to understand your tools.

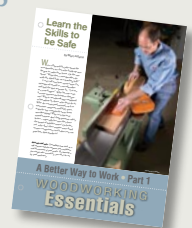

2007 BEST NEW TOOLS



The Winners:

- *Abranet*
- *Apollo*
- *Bosch*
- *Festool*
- *FullPro*
- *Freud*
- *Gramercy*
- *Grizzly*
- *Jet*
- *Lamello*
- *Lie-Nielsen*
- *Milwaukee*
- *Steel City*
- *Veritas*
- *Work Sharp*

After eight years of writing the Best New Tools column, you'd think that we'd be jaded and bored with the tool industry. ("Oh look, yawn, another new cordless drill with a bubble level.")

But every year, all the editors for this magazine sit down with our lists of tools we like, and we are amazed at how many innovative and cool new tools are released every single year. For a craft that is as old as civilization itself, it's a testament to ingenuity that we can continue to find new and better ways to manipulate wood to our liking.

So what do we look for in a tool that makes it a "Best New Tool?" Usually the winners are the tools that make us sit up in our chairs when we first hear about them. They might be tools that have never existed before, such as the Festool Domino – a shoo-in on this year's list. They might be tools that are being revived and improved after near-extinction, such as the Veritas Small Plow Plane or Gramercy Dovetail Saw. They might be tools that are simply the "Best in the Category," such as the Milwaukee two-base router kit or the Apollo HVLP system. They can be tools that make a bold and important statement, such as the riving knife on the Bosch 4100 table saw or the Grizzly jointer/planer – it took guts to bring those European features to the North American market.

And sometimes, a Best New Tool is something that you never ever would have thought of, and is so interesting that you just cannot stop talking about it. I am talking, of course, about the Steel City tools with granite tops and fences. Maybe next year we'll get bored with this annual award – but I wouldn't count on it. — *Christopher Schwarz, editor*

MIRKA Abranet

It was hard for us to imagine that sandpaper could be improved significantly. Sure, we've seen some advances in the longevity of the abrasive during this century, but it wasn't until Mirka introduced Abranet to the world that we saw a major improvement in reducing the worst parts of sanding: the dust and the drudgery.

How does Abranet do this? It's porous, somewhat like drywall sanding screen. So instead of having five holes or eight holes that suck dust through a sanding disk, you get thousands. The difference is incredible the first time you try it. And after using the stuff for more than six months, all of the woodworkers in our shop have switched over to Abranet for power and hand sanding. It's that good.

The fantastic dust extraction of Abranet also speeds your sanding because the stuff is much less likely to load up with dust during use. We're getting about three times the life out of a piece of Abranet compared to our old premium brand—so the increase in expense is more than worth it to us. Abranet is available in all the grits you need (#P80 to #P800) and in a wide variety of shapes and sizes. If you're looking for it locally, a good place to start is your neighborhood Woodcraft.

While no product will ever transform sanding into blissful joy, Abranet comes awful darn close.



Mirka Abrasives Inc. ■
800-843-3904 or
mirka-usa.com

BOSCH 4100 Table Saw

Tool snobs might scoff at our inclusion of a bench-top table saw in this list of the best woodworking equipment, but we know this tool. While traveling the country to do woodworking shows, we used the earlier version of this Bosch to build projects. It's more than accurate and powerful enough for most woodworking tasks (and is a lot more portable than a cabinet saw).

Now Bosch has released a new model with some important changes. Most significant is the European guarding system, which is a vast improvement over standard U.S. guards. Other manufacturers are introducing this style of guard to the market soon, but this is available right now. The guard has a riving knife, pawls and blade covers that can be snapped on and off in seconds. Of all the new guard systems we've seen, Bosch's is the friendliest we've used.

The new saw also is available with a digital rip fence that works down to 32nds of an inch. While this is a nice feature for some woodworkers, we're mostly enamored with the guard, which is still in place on the saw that we've been testing for months.



Bosch ■ 877-267-2499 or boschtools.com

APOLLO Atomizer HVLP

Apollo has always made excellent spray equipment that has performed well in our tests. But the company's new 7500 line of premium HVLP guns is head and shoulders better than the guns we've tested and used for the last 11 years.

We've been testing the A7500QT Atomizer Quick-Release Cup Gun with an HVLP turbine and have been impressed not only with the workmanship and controls, but with the astonishingly small amount of overspray generated by the gun. We're still testing the A7500, but there's little doubt this is the best HVLP gun we've seen in a long time.



Apollo ■ 888-900-4857 or hvlp.com

FESTOOL Domino

So much praise has been written about the Festool Domino this year that it's hard to add anything new. This new handheld loose-tenon tool is quite simply one of the smartest new tools we've ever seen introduced. Yes, some people complain about the price tag, but they haven't used the tool. Once you cut a few mortises with the Domino, you'll join us in our applause for this German company.



Festool ■ 888-337-8600 or festoolusa.com

GRIZZLY 12" Jointer/Planer with Spiral Cutterhead

Combining a jointer and a planer into one machine is nothing new – it's a popular configuration in Europe that has never caught on much in North America.

But now that Grizzly Industrial has gotten its sharp teeth into the category, we think you should take a close look. We saw the new G0634 jointer/planer at the AWFS show in Las Vegas this year and were all quite impressed by the features, workmanship and the astonishing low price: \$2,295.

Just try to get a new 12" jointer and heavy-duty cast-iron planer for that price and you'll see why we think Grizzly is really onto something. The G0634 has the added bonus of being equipped with a helical cutterhead with carbide-insert knives, which ensures long times between tooling changes. And the machine has guts: It's powered by a 5-horsepower, 220-volt motor.

Switching the machine between its two functions is easy. Let me repeat that: it's easy. Don't let anyone tell you different. The only thing we would change on this machine is we wish it had the option of a European-style jointer guard. Grizzly opted for the more

traditional pork chop-shaped guard. But that's just our personal preference.

To be honest, we haven't gotten to use this machine yet – we have one on order. But our long history with Grizzly and our close inspection of the machine convinced

us that this machine belongs on our list (and in our shop).

If you're short on shop space and long on ambition to work with wide solid-wood boards, this Grizzly machine should be at the top of your list.



GRAMERCY 9" Dovetail Saw

Most premium dovetail saws look and act a lot like the very sweet Lie-Nielsen model that has been available for many years. But the Gramercy is different. It has finer teeth, a smaller blade and a smaller brass back.

The net result of these differences is that the Gramercy is decidedly more lightweight and easier to start than its many competitors. We've put this saw in the hands of several dozen woodworkers, and many report that the handle is more comfortable than any other they've used. Perhaps even more telling, we know several woodworkers who abandoned their Japanese saws in favor of the Gramercy – high praise indeed.



Tools for Working Wood ■ 800-426-4613 or toolsforworkingwood.com

FREUD Quadra-Cut Bits

While many router-bit manufacturers have improved their cutters with better carbide and closer manufacturing tolerances, Freud took a big leap forward in 2007 with its new Quadra-Cut bits.

As you might have guessed from the product's name, the Quadra-Cut bits have four carbide cutters instead of the usual two. The additional cutters are pitched in a different direction (two make an upshear cut; two make a downshear). The result: These new router bits remove material efficiently, and they practically eliminate the fuzzy edges produced by profile router bits when cutting across the grain.



Freud ■ 800-334-4107 or freudtools.com

Freud officials say the Quadra-Cuts will cost on average only about 10 percent more than the company's two-cutter bits. New profiles are being added all the time to the Quadra-Cut line – we think they're worth waiting for.

JET JPS-10TS Hybrid Table Saw

The two most important parts of a table saw are its rip fence and its motor. These two components are responsible for making the table saw what it is today: An awesome ripping and joint-cutting machine.

This year we tested hybrid table saws and brought in examples of all the major brands; we had Contributing Editor Troy Sexton go over the saws in detail. Now Troy is hard to impress. He has nice professional machines and knows his stuff. So when Troy freaked out about the Jet model, we knew that something was up. After we started using the Jet's rip fence, we knew exactly what Troy was talking about. The fence slides over the tabletop like it's an air hockey game. You actually have to be careful to make sure the fence doesn't hit the blade sometimes. Add to that the fact that you can adjust the rip fence in all three axes and add jigs to the aluminum faces via T-slots, you might understand why it garnered an "Editor's Choice" award and now also earns a "Best New Tool" award.

So how did the Jet do when it came to raw power? Very well. If you're in the market for a hybrid table saw, you'd be hard-pressed to find anything better, especially for the price (about \$750).

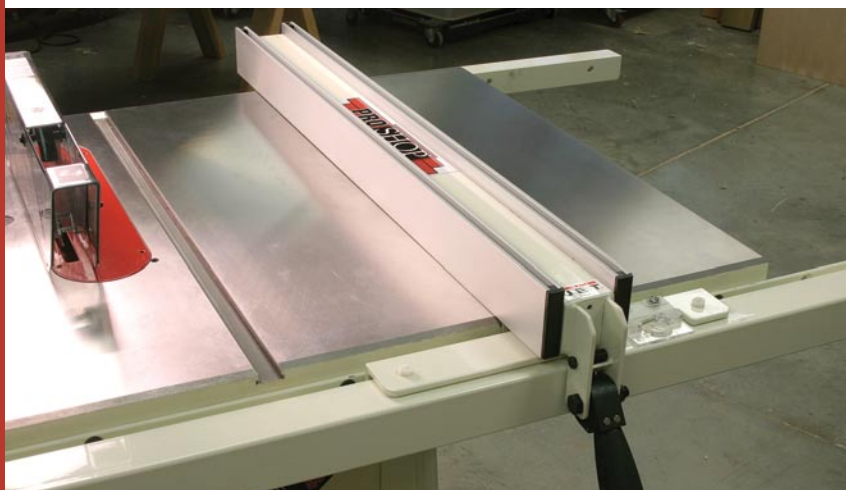

Jet ■ 800-274-6848 or jettools.com

MILWAUKEE 5616-24 Two-base Router

The Milwaukee BodyGrip fixed-base router has been a shop favorite since the day it was introduced. It's stout, accurate and easy to adjust. But Milwaukee didn't have a plunge router to go with it, or even a second plunge base for the BodyGrip's motor.

But in 2007 Milwaukee introduced a plunge base that is worthy of the BodyGrip's reputation. Hands down, the Milwaukee is our favorite two-base router kit. Compared to its competitors, we found that the Milwaukee vibrated the least and had the smoothest plunging operation. The controls are right where you want them. It has power in spades. Switching between the two bases is easy and (more important) this router is the easiest when it comes to changing bits – something you do every day. The only thing we'd change on this outstanding tool is to substitute a base with a square shape instead of a round one. But that's something you can easily do with a piece of scrap plastic or thin plywood.



Milwaukee ■ 800-729-3878 or milwaukeetool.com

FULLPRO SoundVision

Combining ear muffs and eye protection has always been a problem in the workshop. The two safety devices just don't play well together. Now FullPro has used the power of Velcro to fix the problem. Put on the muffs, then attach the eye protection to the muffs using the Velcro straps. It's easy and comfortable. Even after six months of testing, we still like the SoundVision FullPro Protective Gear and use it any time we crank up the big machines.



FullPro ■ 888-873-8557 or fullpro.com

LIE-NIELSEN Large Router Plane

The Lie-Nielsen Large Router Plane might look like the old Stanley No. 71 it's based on, but the Lie-Nielsen is worlds better. It's easier to adjust the cutter and infinitely better when you want to set the tool's depth stop. Plus, as always, the manufacturing quality of the tool is first-rate.

Router planes are great tools for adjusting your joinery, especially dados, tenon cheeks and hinge mortises. Buy one, and you'll be amazed by how many tasks this tool can make easier.



Lie-Nielsen ■ 800-729-3878 or lie-nielsen.com

STEEL CITY Granite-top Saw

The first time we heard a rumor about a granite-top table saw from Steel City Tool Works, we all thought someone was playing a trick on us. Two seconds later, we realized that it was such a brilliant idea that it couldn't be a joke.

Think on this: Granite doesn't rust. It stays flat. It's heavy. When thick enough, it's very durable and long-lasting. And it can be made very smooth and astonishingly flat.

When we first got a gander at the initial Steel City saw with this feature, the 35915G, our suspicions were confirmed. It looks like a great idea. Steel City also is adding granite to the top of its 14" band saw and (most amazingly) to part of its jointer line as the fence. Anyone who has had a jointer with a warped fence (that is, almost everyone) will see the utility of having a granite fence. We're scheduled to receive one of these saws soon. So look for a full review in a future issue.



Steel City ■ 877-724-8665 or steelcitytoolworks.com

VERITAS Small Plow Plane

The Veritas Small Plow Plane is a gem made of iron, steel and brass. Well-made, thoughtfully designed and quite useful, the plow plane will quickly become your favorite tool for making grooves and small rabbets, especially if you value a little peace and quiet while cutting joinery.

We've written a full-page review of this tool in the Tool Test section of this magazine (see page 32), so let us just say here that we think that this plane is further evidence that traditional hand skills are on the rise – after years of neglect and decay. Once you pick up one of these tools and try it a few times, you'll see that the barriers to learning to use hand tools are mostly in your head.



Lee Valley Tools ■ 800-871-8158 or leevalley.com

LAMELLO Fixo Biscuits

The knock against biscuit joining has always been that biscuits don't work well in joining narrow stock. This led to the popularity of pocket screws and the Festool Domino. Lamello has fixed that with its new Fixo biscuits. These barbed, half biscuits act as clamps, pulling joints tightly together from behind. Fast and effective in our tests, and using a tool that we already own, make Fixo biscuits a winner for everyday joinery.



Lamello ■ 781-585-4364 or csaw.com

WORK SHARP WS3000

We've worked with a lot of sandpaper sharpening machines, but this new Work Sharp unit has some features that really set it apart. First, there's the tool rest that is also a heat sink. It really works to keep the tool cool during sharpening. Also, the slotted Edge-Vision wheel allows you to see your tool's edge as it is being shaped.

For woodworkers who dislike hand-sharpening, we think the Work Sharp is the perfect package. **PW**



Work Sharp ■ 800-597-6170 or worksharptools.com

Shaker Workbench

BY GLEN D. HUEY

A stack of drawers and storage under a workbench has Shaker written all over it.

When I started work at *Popular Woodworking* magazine my workbench was a couple storage cabinets on wheels and a cut-off slab of solid-core door. The assembled bench design worked, but then again, it wasn't sturdy, solid or anywhere near going to be the bench that I used for an extended period of time. So it was decided that I should build a workbench. A Shaker-style workbench jumped to the forefront of the many design choices. I wanted a showy bench. One that when looked at in 100 years, most observers would wonder if it was for use or for show.

To create a Shaker design I knew that I needed to have doors and a stack of drawers under the benchtop. In keeping with traditional Shaker benches, I planned to paint the under-chassis. But the structural members, as well as the top, had to be tiger maple – of which over the years I had accumulated quite a stash of less-than-quality figured wood that would do nicely as a workbench top.

Stout Legs and Sturdy Mortises

Start the construction of the bench with the legs. Instead of searching for 16/4 stock that is milled to 3¹/₂" square, look for material that can be glued to the required size. Rough-cut eight pieces of 8/4 stock that is 3³/₄" wide x 34" in length. Each leg is made from a pair of these blanks. Because you want a final size of 3¹/₂", joint only one face of each piece to gain a smooth surface for a good glue joint.

Once the legs are assembled and the glue is dry, mill the pieces to the final dimensions, then begin the layout work to locate the mortises. I oriented the full faces of the legs to the front and rear, keeping each leg's glue line facing the ends of the bench.



Shop box. This bench design features generous amounts of space for working with your tools and storing them when you are done.



 **Online EXTRAS**

For a drawing of the workbench top that shows dog hole locations, a video on how to drill dog holes with a router and a video on how to size drawer parts, go to:

popularwoodworking.com/dec07



A furniture joint on the bench. Shaker craftsmen would employ the dovetail joint for the top rail. To maintain strength in the joint, set the socket back from the front edge.

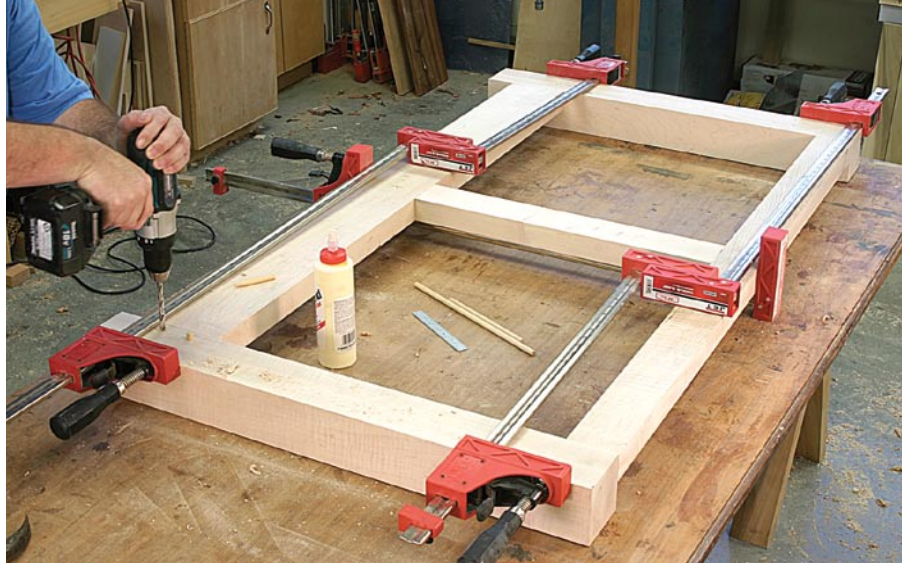

Pin down some strength. The added pins reinforce the joint. Because the size of the dowels match the size of the drill bits, the job couldn't be easier.

The mortises for both ends and the back are identical. Each location receives a 1" x 4¹/₄" mortise for a 5"-wide lower rail and a 1" x 2¹/₄" mortise for the 3"-wide upper rail. The front legs receive an identical mortise for the 3" lower rail at the base of the leg – the rail beginning at 2¹/₂" above the floor. The upper rail is 7/8" thick and 2³/₄" wide. It's a dovetail joint (that's evidence of the furniture maker coming out in me).

There are many ways to cut the mortises. You can make a plywood pattern and use a

plunge router and router bit, you can hog out the majority of the waste material with a Forstner bit at the drill press or you can slave through the work with a mortising chisel and a mallet. I elected to use a dedicated mortise machine. Whichever method you select, cut the mortises to a depth of 1¹/₂".

Creating the Rails to a Strong Joint

Once the leg mortises are made, mill the material for your rails. That batch of material should

also include the beams that stretch from front to back of the base and add support to the bench (see photo at right). The mortises for those beams are cut into the lower front and back rails. You also need to cut the mortises for the rear divider that runs between the rails of the back. A quick step back to the mortising stage then you're ready to cut tenons.

Install a dado stack in the table saw and raise the blade to 3/8". Set the fence to act as a stop for a 1¹/₂"-long tenon. Nibble away the waste material on the four surfaces of each rail exposing the tenon. Fine-tune the fit of each tenon into its respective mortise.

The front top rail is joined to the front leg

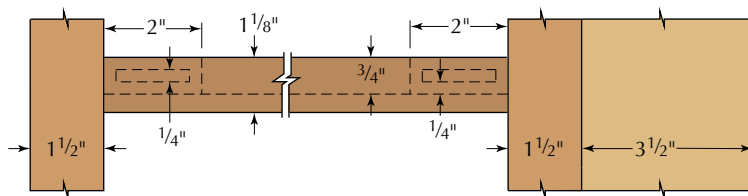

FACE-FRAME-TO-DRAWER-RUNNERS JOINERY

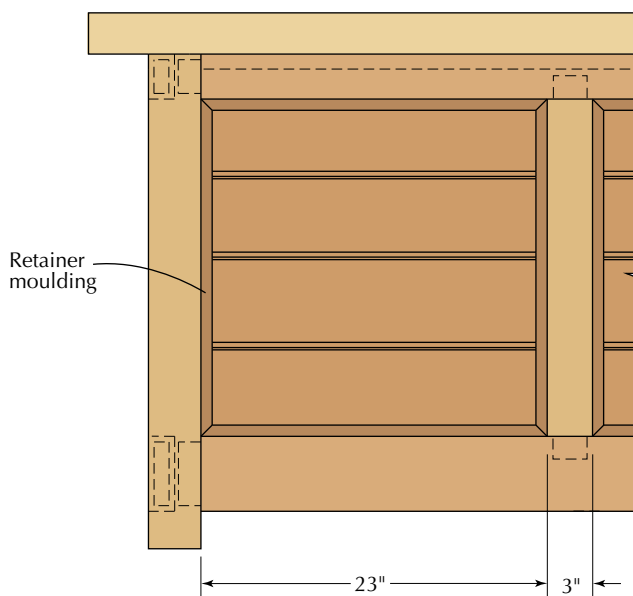

BACK ELEVATION DETAIL

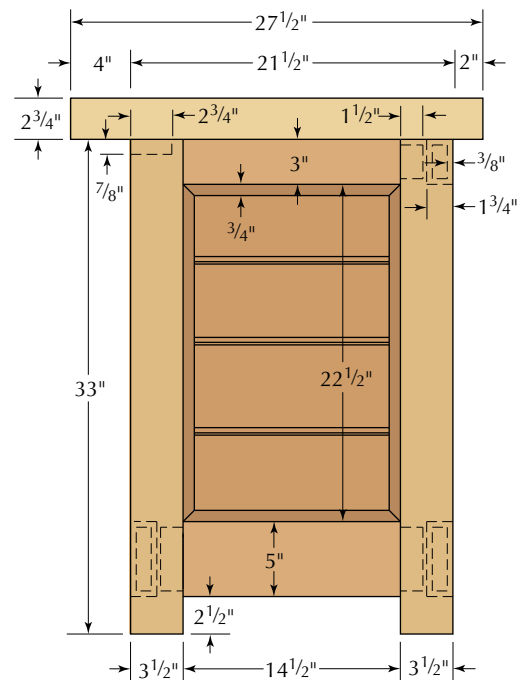

PROFILE



Standing strong and sturdy. All the rails are fit to the legs with mortise-and-tenon joinery. It's possible to simply add a benchtop at this point to have a well-built woodworking bench.

posts with a dovetail joint. Cut the dovetail socket into the top of the legs. Use a handsaw to define the edges of the socket then use chisels to remove the waste.

With the socket complete, fit the top rail to the legs. Slide the lower-front rail into the front legs, then add clamps to secure. Next, scribe the dovetail length onto the front top rail, lay the rail on top of the legs position-

ing the scribe line at the edge of the legs, and transfer the socket layout onto the rail ends. Saw away the waste material. Carefully fit the dovetail to the sockets to get a tight fit.

Assemble the Workbench Base

Work in stages. Sand the inner portions of the legs and the inside of each rail, then add glue to the mortise-and-tenon joints and assemble

the back of the base. Add clamps to secure the assembly. Pin each joint with a $\frac{3}{8}$ "-diameter dowel. Use two pins in the wide rails and a single pin in the 3" rails.

Next assemble the bench base's front. I added a #8 x $1\frac{1}{2}$ " screw to reinforce each dovetail joint and pinned the lower rail of the front with a single dowel pin in each joint.

For the ends, glue the rails' tenons into the mortises and pin those joints as well. Don't forget the beams in the bottom of the base. Installing these parts makes the assembly of the base a bit tricky. It's necessary to slide all the joints together at the same time. When complete, the base structure of the workbench is standing strong.

Making Beaded Panels

To achieve a Shaker look on the exterior of the bench I decided to fill in the open areas between the ends and back with tongue-and-groove pieces. To add a bit of excitement I included a bead detail on each piece.

Cut the tongue-and-groove joints at the table saw. First mill the pieces necessary to fill each opening. Lay out the pieces edge to edge and mark the edges that get a groove and the mating edges that get a tongue. The starting piece has a groove only while the ending piece will have only the tongue. All remaining pieces have both a tongue and a groove.

Cut a $\frac{1}{4}$ "-wide groove centered on the

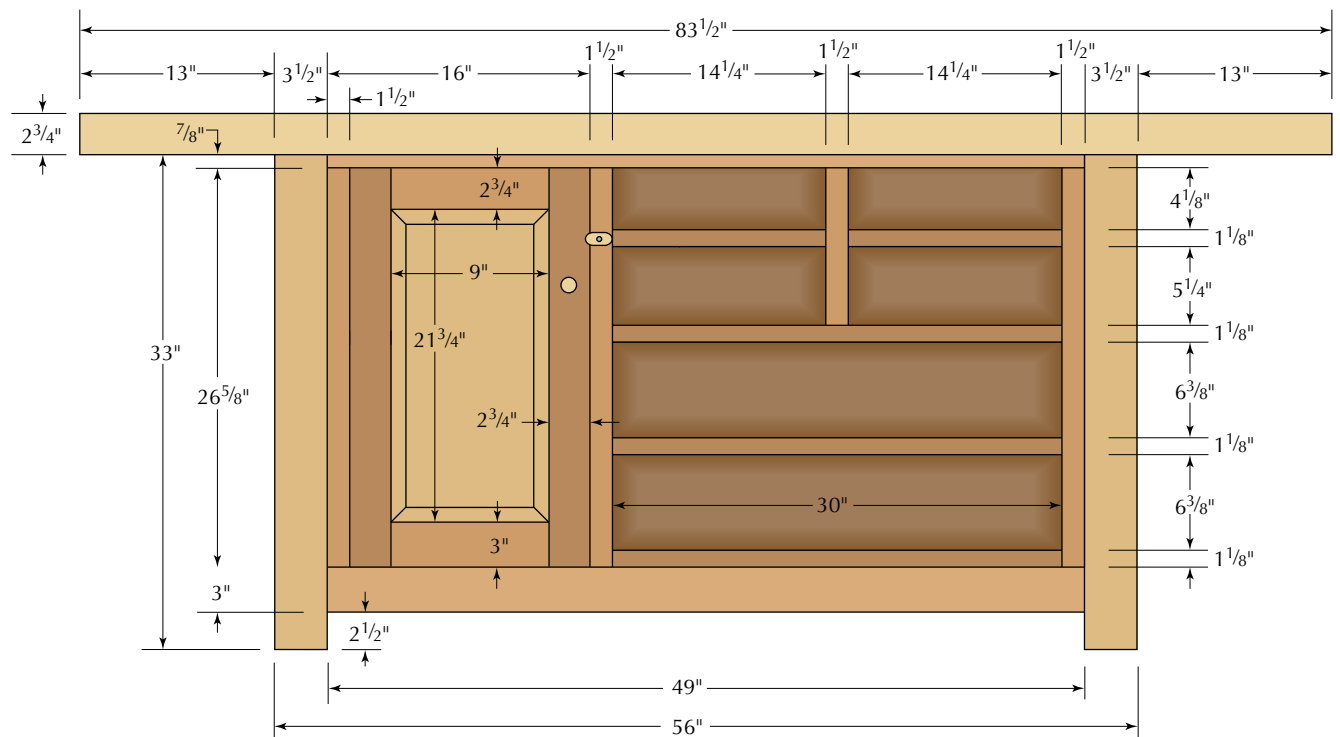

ELEVATION

edge of the boards. To do this, set the blade height to $\frac{3}{8}$ " and the area between the fence and the blade at $\frac{3}{16}$ ". Make a single pass over the blade, then reverse the board and make a second pass. The result is a $\frac{1}{4}$ "-wide groove that's centered on the edge.

Making the matching tongue is also a job for the table saw. This time set the blade height to $\frac{3}{16}$ ". Making the tongue is a two-step rabbet cut completed on both faces of the piece. Make the first pass with the board lying face



Routing a bead detail. The bead detail is placed on the tongue portion of the joint. Cutting the profile on the groove would weaken the joint considerably.



Sandwiching the panels. The panel backing, along with mouldings, hold the panels in position. The backings are screwed to the inside face of the rails as well as to the legs.

down on the table saw surface. Cut both faces of the boards that get a tongue.

Now adjust the blade height to $\frac{3}{8}$ " and position the fence at $\frac{7}{16}$ ". Cut the boards on edge to finish the tongue. This setup makes the cut so the fall off is not trapped between the blade and the fence, and the result is a $\frac{1}{4}$ " tongue. Slight adjustments might be necessary to obtain an exact fit. The joint should slide together easily without the aid of a mallet or your palms. A joint that's too tight at this stage will present problems later, after paint is applied.

The bead detail is fashioned at the router table with a $\frac{1}{4}$ " beading bit and is cut on the tongue portion of the joint. If the bead were cut onto the groove area the joint would fail due to material breakage.

Set the height of the beading cutter so the lower edge of the router bit bead profile is aligned with top edge of the tongue. Rout the detail into each piece that gets a tongue.

Holding the panels in place is accomplished with a combination of backing strips and mouldings. The backing strips are $\frac{5}{8}$ "-thick material that are attached with screws to the inside edge of the legs and vertical, back divider as well as the top and bottom rails. The strips surround the openings and hold the beaded panels in position. The retainer mouldings trap the panels and are added after the balance of the base is complete and the panels are painted.

A Flat-panel Divider

The first step to constructing the interior of the bench is to make the vertical flat panel that divides the drawer bank from the storage area fronted by a door. The panel is created with rails, stiles and a floating panel.

Use mortise-and-tenon joints to build this panel. Cut the pieces to size according to the cut sheet. I use a mortiser to make the $\frac{1}{4}$ "-wide x $2\frac{1}{4}$ "-long x $1\frac{1}{4}$ "-deep slots.

Next, cut a $\frac{1}{4}$ "-wide x $\frac{3}{8}$ "-deep groove on the four pieces of the frame at the table saw (just as the groove on the beaded panels was created). The fence settings are different from the earlier setup due to the thicker stock of the frame.

Cut the matching tenons next. Set the table saw blade to a height of $\frac{1}{4}$ " and set the fence to cut a $1\frac{1}{4}$ "-long tenon. Make the cheek shoulder cuts on each end of the rails, then raise the blade to $\frac{3}{8}$ " and make an edge shoulder cut on the interior edge of the rails only.

The fence has to be adjusted to make the

haunch cut in the outer edge of the rail. Move the fence toward the blade $\frac{3}{8}$ " and make a second edge-shoulder cut. You can see the haunch appear as the cut is made. The $\frac{3}{8}$ " offset in the fence matches the depth of the groove. The haunch will fill the plowed out groove.

To fit a flat panel to the frame you need to create a series of rabbets along each edge of the panel. The resulting tongue slips into the groove in the frame and is centered on the panel's edges. Set the blade height and fence both at $\frac{1}{4}$ ", then run each edge of one side of your panel over the blade. Flip the panel and run the second set of cuts with the settings the same.

Next, stand the panel on edge and raise the blade to clear the top edge of the previous cut. Adjust the fence to leave $\frac{1}{2}$ " between it and the blade. Make the cuts to create the tongue on the panel. Cut all four sides then reverse the panel to cut the remaining four sides allowing the tongue to emerge. Add glue to the mortise-and-tenon joints—but not on the floating panel and assemble the flat-panel divider.

Install the completed divider into the bench base with pocket screws. Two screws are set into the beam of the base and one additional screw is positioned into the top rail of the back. The divider is held to the front of the bench by the face frame, which defines the drawers and storage area.

Putting on Your Best Face

The face frame for the workbench is built using a series of half-lap joints between the rails and stiles. This joint is strong, and because the face-frame pieces are narrow this joint

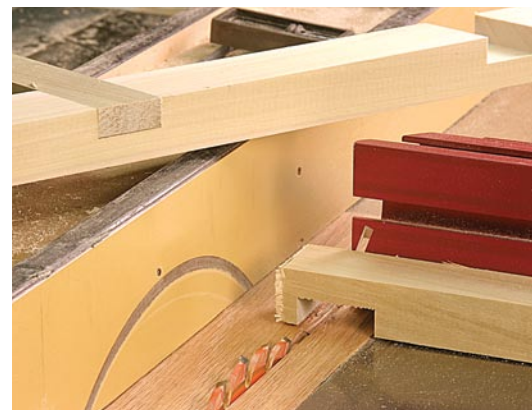

Perhaps the strongest joint. Given the narrow stock used for the face frame, the half-lap joint is stronger by far here than a mortise-and-tenon joint would be. This frame will be together a long time.

offers more strength than a mortise-and-tenon could. The concept is to have the horizontal dividers pass behind the vertical dividers at each half-lap location. Pay attention to detail as you cut these joints.

Begin the half-lap joinery by milling the three vertical pieces, plus the divider that splits the top two rows of drawers and the four pieces

that are drawer dividers. There is no top rail for the face frame – the top front rail of the base acts as the face frame's top rail.

Set the blade height to $\frac{3}{8}$ ". After laying out the location of the drawer dividers according to the plan, use a miter gauge to guide the vertical pieces over the blade to remove the waste material. This requires a number of steps with

each half-lap area being nibbled away. Find and cut the half-lap areas into the two drawer dividers for the center divider.

Making the cuts on the drawer divider ends is the easy cut. In fact, you can cut the half-laps at the ends of the drawer dividers and for the lower drawer divider into the three vertical dividers with the same setup.

Slide the fence toward the blade. Leave the appropriate length for the mating part of the joint, but don't change the blade height. Make the first pass over the blade to establish the length, then nibble away the remaining material. Test the joint for both width of cut and fit of the joint. A good half-lap joint finishes the same thickness as the material used in the joint.

To find the location of the half-lap joints in the center divider it's best to assemble the face frame and position the center divider flush with the top of the face frame assembly. There you can mark the areas that need to be removed for the drawer dividers as well as the overall length of the center divider. Then, it's back to the table saw to complete the joinery. Once the joints are made and fit, add the glue and clamps to assemble the face frame.

The face frame sets back 1" from the front edge of the base rails. Remember to position and glue the vertical divider on the left-hand side of the door. Attach the assembled unit to the base of the workbench with glue and clamps. Also, join the face frame and the flat panel divider with glue and a couple finish nails, which act as clamps while the glue sets.

Precise layout.

Matching the center divider to the face frame ensures the fit is correct. It's best to get exact measurements versus using a plan.



Well-placed clamps. Clamping the face frame to the bench base does not require scads of clamps. Strategic placement and having a square frame guarantee an accurate glue-up.

Supplies

LeeValley

800-871-8158 or leevalley.com

- 1 ■ large quick-release vise #10G04.13, \$139
- 1 ■ small quick-release vise #10G04.11, \$95
- 1 pair ■ Bench Pups, 2 $\frac{3}{8}$ " #05G04.04, \$19.95
- 1 ■ Wonder Pup #05G10.02, \$29.50
- 1 ■ Veritas surface clamp #05G19.01, \$62.50

Olde Century Colors

800-222-3092 or oldecenturycolors.com

- 1 quart ■ acrylic latex, Cupboard Blue, #2003, \$14.25

Prices correct at time of publication.



In addition, drive a screw through the bench's top rail into the ends of the vertical face frame pieces.

Support for the Drawers

The face frame divides up the drawer bank, but the drawers run on a web frame that attaches to the backside of the dividers. Each web frame is $\frac{3}{4}$ " thick and the dividers are $1\frac{1}{8}$ " wide. To work, the frames need to be held flush with the top edge of the dividers. Each frame has a piece at the front called the extension and two runners.

The drawer web frames start with the drawer extension. The extensions run from side-to-side of the drawer opening, bridging the half-lap joints and have $\frac{1}{4}$ "-wide x $1\frac{1}{2}$ "-

Nails provide the connection. The drawer frames are held in place with nails. Make sure the runners are level by starting at the bottom and measuring each location based off the front divider.

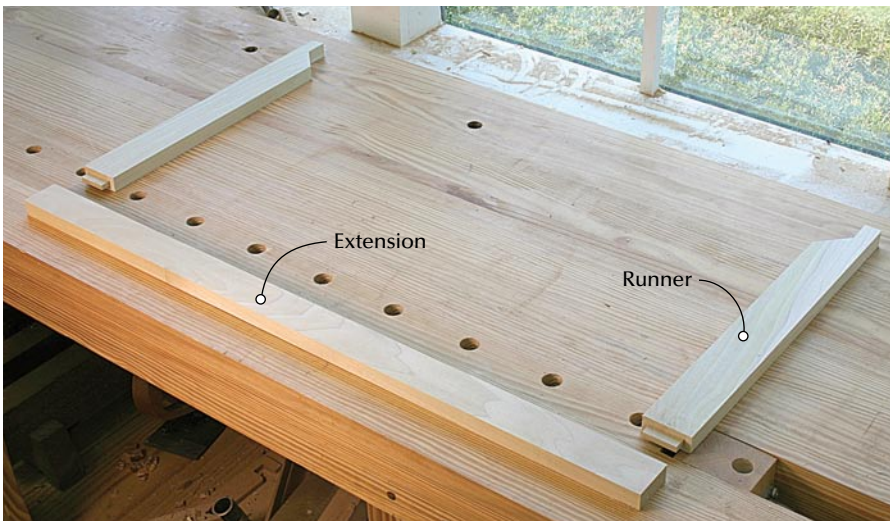

The simple drawer frame. The lower frames for the drawers are quickly completed once the mortises and tenons are made. Assemble the frames and square the runners off the extension.

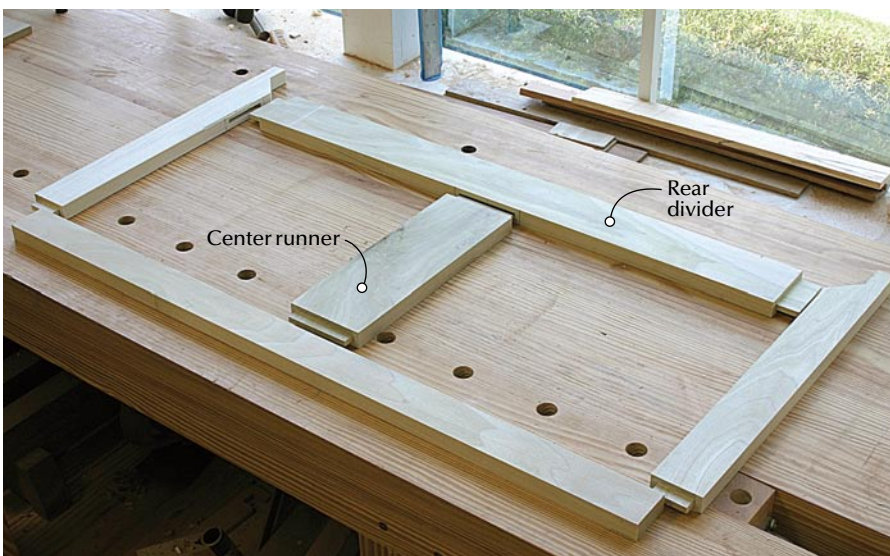

Split drawers add work. The frames for the upper drawers require three additional mortises as well as a rear divider and a center runner. And with mortises come tenons.

long x $\frac{1}{2}$ "-deep mortises cut in each end of the rear edge for the runners' tenons.

The runners begin as 2"-wide stock. Form a $\frac{1}{2}$ "-long tenon on one end of each runner while the other end, the end nailed to the rear leg or flat-panel divider, is notched to use a $1\frac{1}{2}$ " nail. Once the completed frames are in position, measure the location of the rear of the frames then add nails to secure the frames in place.

The lower frames are completed with the attachment of the runners to the extensions. Glue the tenons into the mortises and set the assemblies aside until dry.

However, the upper frames are different. Because the upper two rows of drawers are split, those frames also require a center runner that provides support on either side of the center vertical divider. The drawer extensions for those two rows need to have a third mortise to house the center runner. Position the runner in the center of the opening, not centered across the extension. Because of the center runners, it's necessary to install a rear divider that extends between the runners and fits into mortises placed in the runners. The center runner is attached to the rear divider with a mortise-and-tenon joint as well.

It's important to have plenty of clamps on hand or move through the installation of the frames in steps.

Drawers, Door and Trays

The door's frame is built just as the flat-panel divider was earlier. Use mortise-and-tenon joints with a haunch at the corners. The only difference is the door has a raised panel instead of a flat one. Create the raised panel at the table saw or with a raised panel cutter at the router table. Slip the panel into the groove as the door is assembled. Glue only the joints. The door is installed after the finish is applied.

Make the drawers using traditional dovetail joinery. The lipped fronts are rabbeted on three sides after the edges are rounded with a $\frac{3}{8}$ " roundover bit. The balance of the drawer parts are determined from the inside face of those fronts.

The 16"-long drawer sides are the same width as the inside of the fronts from the bottom edge to the start of the rabbet.

The drawer back is $\frac{3}{4}$ " less than the width of the drawer sides—the drawer bottom slides under the back and into grooves in the sides and front—and the length is equal to the inside face of the drawer front from rabbet to rabbet.



Clamps galore. Attaching the rail extensions to the face frame dividers requires many clamps. It's best to stage the process working one frame at a time. Once dry, level and nail the runners at the back.

Use through-dovetails to join the drawer sides to the backs and half-blind dovetails to join the drawer fronts to the sides. The drawer bottoms are bevel cut at the table saw to slide into a $\frac{1}{4}$ " groove that is plowed into the drawer front and sides prior to assembling the drawer boxes.

The trays that fit into the storage area behind the door operate on full-extension drawer slides. The sides of the trays themselves are $2\frac{3}{4}$ "-wide stock that is joined at the corners with through-dovetails. Remember to correctly size the box. The final width is dependent on the slides selected. The slides used on this project require a $\frac{1}{2}$ " of clearance per side, so the tray box is 1" narrower than its opening.

With the tray boxes built and assembled, use brads to attach a ledge around the interior of the box for supporting the removable tray bottoms.

The full-extension slides need to be shimmed from behind so they are flush with the door opening. On the right-hand side, as you face the door, nail $\frac{5}{8}$ "-thick x 2"-wide material to the flat-panel divider. The area on the left-hand side of the storage area requires $1\frac{1}{2}$ "-thick stock to build out for the slides. Screw these to the legs.

The bottom tray is aligned with the top edge of the base rails – just high enough to bypass the rails as the tray is pulled out. The second tray is 12" above the first tray. In order to keep the trays level from front-to-back and side-to-side, use a pair of spacers to position the top tray assembly.

To finish the construction of the base of the bench, add two blocks at the top edge of the ends to provide a method to attach the top. The $1\frac{1}{4}$ "-thick material is fit between the front and rear leg and glued in place.

A Showy Workbench Top

The top of a workbench is its important feature. This surface receives the most wear and should be solid (and showy) in my view. This bench has a tiger maple top that's $2\frac{3}{4}$ " thick that begins as 3"-wide material. The top is a 32-piece lamination of hardwood that was ripped, milled and assembled into one heavy slab of lumber.



Drawer work begins. The table saw allows you to fine-tune the fit of the drawer. Measurements for other drawer parts are based off the inside face of the drawer fronts.

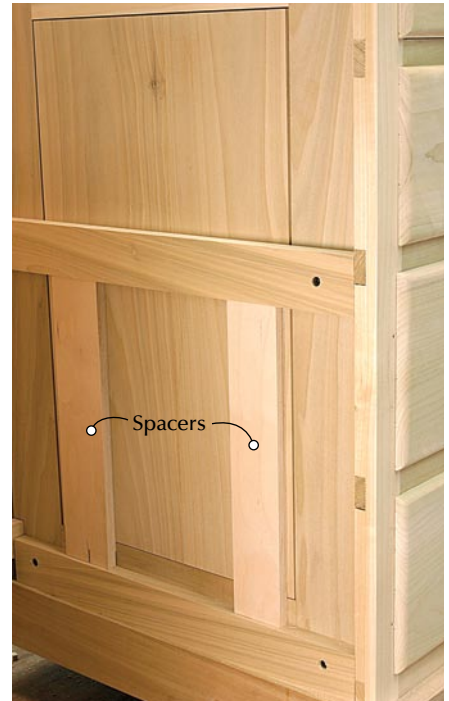

Keeping trays level. The pull-out trays need to be level from front to back and from side to side. To ensure that happens, use spacers.



Counting pieces. The top was laminated from 32 pieces of lumber. Work in stages, please. Trying to laminate all the pieces at once will be a glue-filled mess.

I ran each piece over the jointer to gain a straight, flat surface, then through the thickness planer to achieve a uniform thickness. From there, they were grouped and glued into three workable sections. Each of the three sections, when removed from the clamps, was once again jointed and planed to be straight, flat and uniform in thickness. Additionally



Jointing a flat surface. The stock for the top begins oversized to allow multiple trips to the jointer and planer. Having a level and true workbench top is paramount in bench making.

the top was surfaced with a wide-belt sander to arrive at the final dimension.

The last step was to assemble the three sections. That left two joints that had to be worked by hand. Pay particular attention to the joint when gluing the final sections together. Any variations in the joint directly transfer to additional handwork to straighten and level.

The vises selected for your bench are a reflection of your work habits. I like a quick-release vise for both my front and my end vise. Every vise is supplied with installation instructions that should be followed completely.

Drilling round holes for bench dogs – no square-cornered dogs for me – was last on the list prior to beginning the finish. After hearing stories of woodworkers burning up drills or using the man-powered brace and bit and auger, I knew I had to find an easy method to drill my holes. Using the router to drill holes for adjustable shelf pins flashed through my thoughts. Could we apply that same method to the bench? Yes.

Use a $\frac{3}{4}$ " up-cut spiral router bit (Woodcraft #03K53 \$38) and the router to plunge-cut those holes. To keep the router positioned as the hole is cut, make a template that traps the base of the router (see photo below left). Clamp the template in place, position the router then plunge the holes. It's easy. To guarantee accurate hole locations, mark a centerline on the edge of the template and align that mark with the layout lines for your holes.

Drilling in the edge of the workbench top



Picture-frame moulding. The panels on the base are held in place by the moulding that is installed in picture-frame fashion – the corners are mitered.

is another mystery to solve. I again used the router but the surface area was too narrow to plunge cut without concerns. To alleviate any problems, clamp a long guide to the base plate then clamp the guide to the top before plunging the cut. These front holes allow clamping

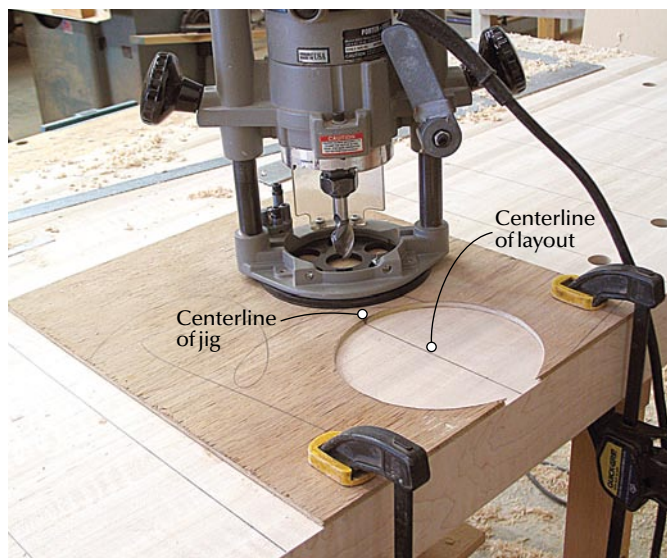

Jigging up the router. Drilling holes for bench accessories is a task that can kill a drill, but with a plunge router and upcut router bit, the job is short and sweet. Align the centers and rout.



Hold-down holes. A second rigging is needed to drill the holes in the top's front edge. These holes are for accessories that hold wide panels in place.

of wide materials in the face vise. The top and base are attached with four 5" hex-head bolts with nuts and washers that are countersunk into the top and extend through the attachment blocks. The bench is now ready for finish.

Paint and Finish

All the panels and materials made in poplar are painted (Olde Century Colors "Cupboard Blue" acrylic latex). That includes the beaded panels, the face frame, the drawer fronts and the door. Paint two coats on all surfaces, sanding between coats. Once the painting was complete I could go back and add the moulding to lock in the beaded panels. That moulding is installed with mitered corners.

The finish on the top and all the tiger maple framing is an oil/varnish mixture I've used for years. (See "Finishing Formulas" in April 2007, issue #161). Two coats were applied over everything. That's right, everything—including the painted parts of the workbench.

Hang the door using light-duty T-hinges along with a wooden knob and door catch.

I envision many years of building furniture on this bench. I wish I had built a quality workbench years back. Not that it would have improved my work, but maybe my work habits. No more scattering tools in the shop. I now have a workbench that has storage. **PW**

Glen D. Huey is a senior editor of Popular Woodworking, a published author, the host of the Woodworker's Edge DVD series. Contact him at 513-531-2691 x1293 or glen.huey@fwpubs.com.



Popping the grain. Two coats of an oil/varnish mixture is all the protection necessary for the bench. You don't want too much finish on the top. There's no need to have pieces sliding about.

Shaker Workbench

NO.	ITEM	DIMENSIONS (INCHES)			MATERIAL	COMMENTS
		T	W	L		
4	Legs	3 ¹ / ₂	3 ¹ / ₂	33	Tiger maple	
1	Front lower rail	1 ³ / ₄	3	52	Tiger maple	1 ¹ / ₂ " tenon both ends
1	Rear top rail	1 ³ / ₄	3	52	Tiger maple	1 ¹ / ₂ " tenon both ends
1	Rear lower rail	1 ³ / ₄	5	52	Tiger maple	1 ¹ / ₂ " tenon both ends
2	End top rail	1 ³ / ₄	3	17 ¹ / ₂	Tiger maple	1 ¹ / ₂ " tenon both ends
2	End lower rail	1 ³ / ₄	5	17 ¹ / ₂	Tiger maple	1 ¹ / ₂ " tenon both ends
1	Rear divider	1 ³ / ₄	3	25 ¹ / ₂	Tiger maple	1 ¹ / ₂ " tenon both ends
2	Base beam	1 ³ / ₄	3	21	Poplar	1 ¹ / ₂ " tenon both ends
1	Front top rail	7/8	2 ³ / ₈	51	Tiger maple	1" dovetail both ends
Flat-panel Divider						
2	Stiles	3/4	3	26 ¹ / ₂	Poplar	
2	Rails	3/4	3	14 ¹ / ₂	Poplar	1 ¹ / ₄ " tenon both ends
1	Flat panel	3/4	12 ⁵ / ₈	21 ¹ / ₈	Poplar	
Beadboard Panels						
2	End panels	5/8	14 ⁷ / ₁₆	22 ³ / ₈	Poplar	Assembled pieces
2	Rear panels	5/8	22 ¹⁵ / ₁₆	22 ³ / ₈	Poplar	Assembled pieces
Panel Backing						
4	Horizontal end	5/8	5/8	14 ¹ / ₂	Poplar	
4	Vertical end	5/8	5/8	22 ¹ / ₂	Poplar	
2	Horizontal rear	5/8	5/8	50	Poplar	
4	Vertical rear	5/8	5/8	22 ¹ / ₂	Poplar	
Face Frame & Drawer Frames						
3	Vertical dividers	3/4	1 ¹ / ₂	26 ⁵ / ₈	Poplar	
4	Drawer dividers	3/4	1 ¹ / ₈	33	Poplar	
1	Center divider	3/4	1 ¹ / ₂	11 ³ / ₄	Poplar	
4	Rail extensions	3/4	1 ³ / ₄	31 ¹ / ₂	Poplar	
8	Drawer runners	3/4	2	16 ¹ / ₂	Poplar	1/2" tenon one end
2	Center runners	3/4	3 ¹ / ₂	11 ¹ / ₄	Poplar	1/2" tenon both ends
2	Rear dividers	3/4	2 ³ / ₄	29 ¹ / ₂	Poplar	1/2" tenon both ends
4	Drawer guides	5/8	3/4	15	Poplar	
2	Center guides	5/8	1 ¹ / ₂	15	Poplar	
Door Parts						
2	Stiles	3/4	2 ³ / ₄	26 ¹ / ₂	Poplar	
1	Top rail	3/4	2 ³ / ₄	11 ¹ / ₂	Poplar	1 ¹ / ₄ " tenon both ends
1	Bottom rail	3/4	3	11 ¹ / ₂	Poplar	1 ¹ / ₄ " tenon both ends
1	Raised panel	5/8	9 ⁵ / ₈	22 ³ / ₈	Poplar	
Drawer Fronts (Other drawer parts taken from these sizes)						
2	Top row	3/4	4 ¹ / ₈	14 ⁷ / ₈	Poplar	
2	Second row	3/4	5 ¹ / ₂	14 ⁷ / ₈	Poplar	
1	Third row	3/4	6 ⁵ / ₈	30 ⁵ / ₈	Poplar	
1	Fourth row	3/4	6 ⁵ / ₈	30 ⁵ / ₈	Poplar	
2	Tray fronts	3/4	2 ³ / ₄	13 ¹ / ₂	Poplar	
2	Tray sides	3/4	2 ³ / ₄	16	Poplar	
2	Tray bottoms	3/8	12	14 ¹ / ₂	Plywood	
Misc. Parts						
2	Right ext. filler	5/8	2	17 ¹ / ₄	Poplar	
2	Left ext. filler	1 ¹ / ₂	2	17 ¹ / ₄	Poplar	
2	Attachment block	1 ¹ / ₄	1 ¹ / ₂	14 ¹ / ₄	Tiger maple/poplar	
1	Workbench top	2 ³ / ₄	27	84	Tiger maple	Laminated
1	Vise block	3 ³ / ₈	1 ¹ / ₂	15 ¹ / ₂	Tiger maple	
31 lf	Retainer moulding	3/4	3/4		Tiger maple	

Variable-spaced DOVETAILS *by* JIG

Two methods to move beyond the limitations of a fixed-space dovetail jig.

BY DON MEANS

Some of us just don't have the time, patience or skill to produce hand-cut dovetail joints and instead resort to one of the numerous dovetail jigs available on the market. However, at several hundred dollars apiece, not everyone can justify the expense of a variable-space jig, such as the Leigh D4R. Even if you do happen to own this fine jig, for certain applications I find it easier and more efficient to use a simpler jig. For example, when building cabinets or furniture for my workshop I usually don't want to spend the time setting up my Leigh D4 (yes, I do own one). However, I still want the dovetail joinery to have aesthetic appeal.

I've experimented with a number of dovetail router bit sizes and cutting angles and, using a basic fixed-finger dovetail jig, have refined two techniques that greatly improve the overall aesthetics of the resulting half-blind dovetail joint. In addition, with a bit of planning, and within certain limitations, it is even possible to create "variable-spaced" half-blind dovetails with this "fixed-finger" jig.

Dovetail Jig Geometry

In order to fully utilize these techniques, it is helpful to have an understanding of the geometry surrounding the dovetail joint produced by the fixed-finger jig. Although jigs of this type generally operate the same way (that is, the pins and tails are produced in a single

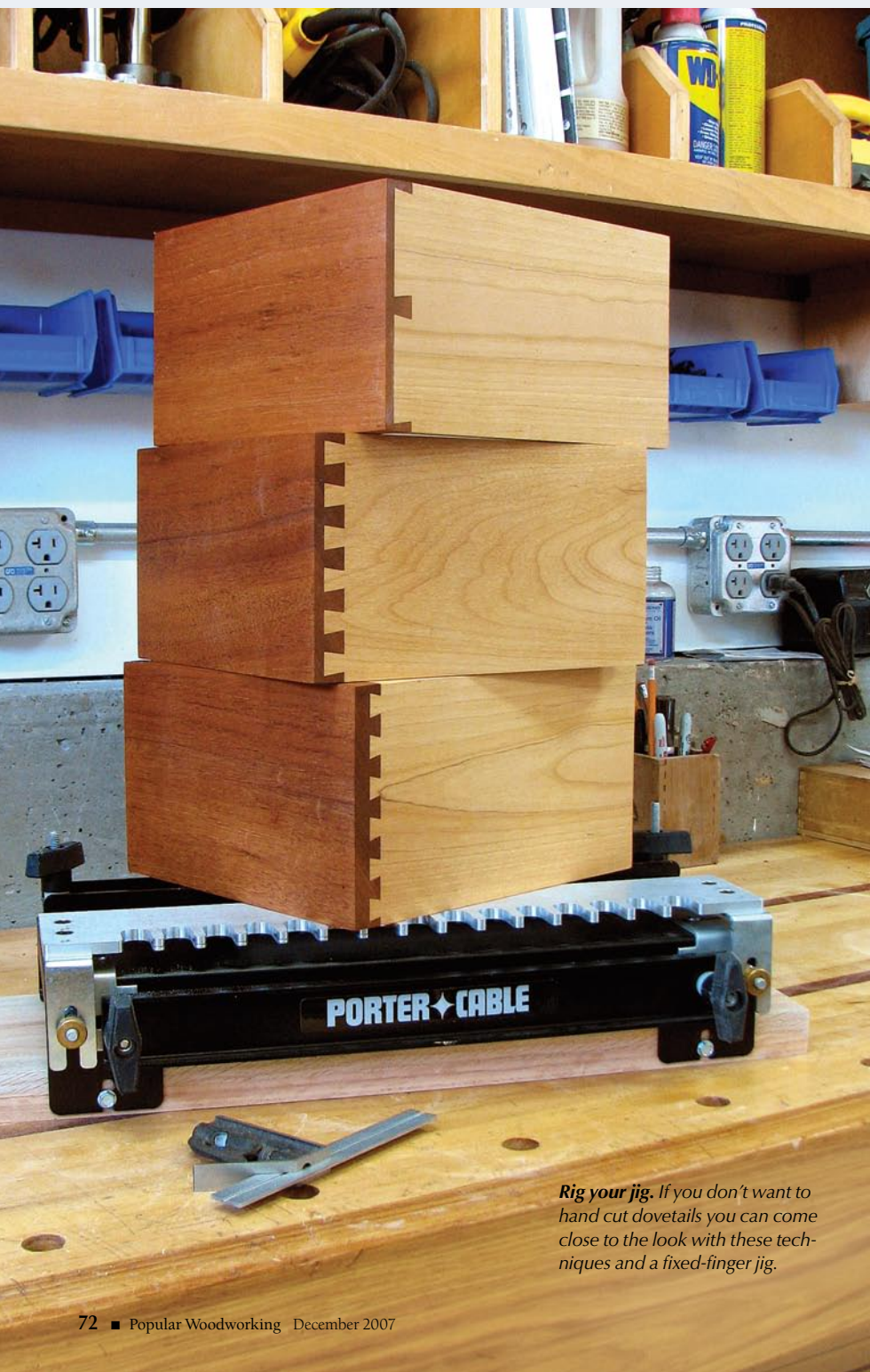

Rig your jig. If you don't want to hand cut dovetails you can come close to the look with these techniques and a fixed-finger jig.

operation) not all of them have the same geometric characteristics. For example, the Porter-Cable and Hartville jigs are similar, while jigs by Rockler, Jet and Woodtek have slightly different characteristics. For this article, I worked with the Porter-Cable 4112 dovetail jig equipped with a 1/2" half-blind dovetailing template. However, it should be possible to apply this technique to just about any fixed-finger dovetail jig, once you understand the basic geometric relationships.

When using a fixed-finger jig, the dovetail bit diameter and center-to-center finger spacing are the critical dimensions that control the geometry of the dovetail joint. The key geometric relationship for the joint is the amount of overlap or interference between the tail and the pin.

This relationship is determined by (1) the center-to-center finger spacing, and (2) the diameter of the dovetail cutter. The slope or angle of the dovetail bit is secondary to this relationship. In fact, this is what we are going to "play with" in order to improve the appearance of the joint.

Adjusting the depth of cut determines the amount of interference between the tail and pin, and determines the fit of the joint. As the angle of the dovetail bit is reduced, it is necessary to increase the depth of cut in order to maintain the proper tail/pin interference. This reduced or slighter angle, as well as the increase in the depth, is the key to improving the appearance of the joint.

For these types of fixed-finger jigs, the relationship between center-to-center finger spacing, cutter angle, diameter and, ultimately, cutter depth is defined by the following formula:

$$\text{Depth of Cut} = \{D - S/2\} \div \text{Tangent}(a)$$

where:

D = dovetail bit diameter

S = dovetail jig center-to-center finger spacing

a = cutter angle (in radians)

This formula provides the insight we are seeking. As you can see, for a given cutter diameter and finger spacing, the cutter angle is inversely proportional to the depth of cut. As the cutter angle is decreased the depth of cut must increase.

This formula might be the end of our minor math lesson if we were cutting dovetails in metal with a precision CNC mill. Unfortunately, we are cutting with tools that have a variety of associated built-in errors (router and bit run-out, bushing and template fit and

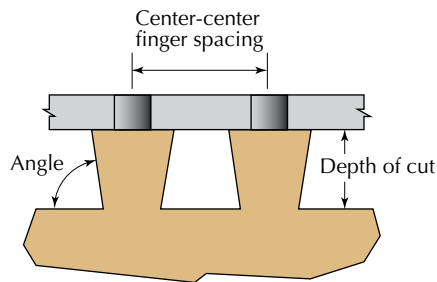

CRITICAL DOVETAIL DIMENSIONS

bushing/router eccentricity, to name a few). All these factors result in an effective increase in the diameter of the cutter.

A 1/2" cutter will tend to act like a slightly larger bit. With my equipment (the PC jig and a DeWalt 621 router) I found through trial and error that all of these imperfections added about .010" to the bit diameter. In other words, a 0.500"-diameter router bit acts like a 0.510"-diameter bit. This effective diameter should be used to calculate the estimated depth of cut provided in the preceding formula. (Note: Everyone's tools are slightly different so you will have to experiment to find the amount of variation in your setup.)

Planning the Width (Plus or Minus)

For the majority of applications, the most aesthetic arrangement for half-blind dovetails is to end with a half-pin at the upper and lower edge of the drawer side (or tail board). Unfortunately, when using a fixed-finger dovetail jig this requires the side of the drawer to be limited to certain widths. Some planning is necessary to ensure the joint ends on a half-pin. The Porter-Cable 4112 has a center-to-center finger spacing of 7/8" so in theory, drawer side widths have to be multiples of this dimension.

But it isn't necessary that the half-pins be exactly one-half the pin width. A typical 1/2"-dovetail cutter will produce a throat width that is approximately 3/8" (therefore the half-pin throat width would be about 3/16"). As long as you are close to this dimension ($\pm 1/16"$ at

most) the joint will look OK. Because there are two half-pins on each drawer side this allows a total variation of $\pm 1/8"$ over the drawer side. The chart below lists the possible sizes under this parameter.

Most moderately priced dovetail jigs include a basic 1/2" diameter, 14° dovetailing bit. Under normal operation these cutters produce a "stubby" dovetail joint, with tails approximately 3/16" long. In addition, the 14° angle of the tail is not very graceful.

Although there are a variety of dovetail cutters on the market, only a few have the proper cutting geometry that will allow them to work with the typical fixed-finger jig. See the chart below for cutters I have found that work with this technique.

A Simple Improvement

A basic improvement when using the fixed-finger jig is to simply substitute a 1/2"-diameter, 8° cutter (such as the #80 bit for the Leigh jig) for the standard cutter. Set up the jig as you normally would by following the manufacturer's instructions. The only change to the normal setup is the depth of cut – which should be

Drawer Side Width*

MULTIPLIER OR FINGERS	NOMINAL WIDTH (INCHES)	MINIMUM WIDTH (INCHES)	MAXIMUM WIDTH (INCHES)
3	2 5/8	2 1/2	2 3/4
4	3 1/2	3 3/8	3 5/8
5	4 3/8	4 1/4	4 1/2
6	5 1/4	5 1/8	5 3/8
7	6 1/8	6	6 1/4
8	7	6 7/8	7 1/8
9	7 7/8	7 3/4	8
10	8 3/4	8 5/8	8 7/8
11	9 3/8	9 1/2	9 3/4

* Note: This chart provides the typical drawer side widths that are possible when using the PC 4112 dovetail jig and similar jigs with equivalent finger spacing. When properly set up in the dovetail jig, these widths will result in a half-pin at each end of the drawer.

Commercially Available Dovetail Bits That Can be Used in Fixed-finger Jigs

	STANDARD	LEIGH (#101)	INCRA	LEIGH (#80)	CUSTOM*
Cutter diameter	1/2"	1/2"	17/32"	1/2"	17/32"
Effective diameter	0.510"	0.510"	0.542"	0.510"	0.542"
Angle or slope	14°	10°	14°	8°	1:6
Depth of cut	19/64"	26/64"	27/64"	33/64"	5/8"

Most manufacturers make bits in the sizes listed above. * Whiteside will custom-make this bit (or any other for that matter) for a price of around \$200. It is only shown here to indicate what the characteristics of the "optimal" router bit for this technique would consist of – if you are prepared to pay for it!

set to about $25/32$ ". The actual length of the tail will be about $17/32$ ". However, when measuring the cutter depth from the base of the router, it is necessary to take into account the thickness of the finger plate ($1/4$ " in this case).

It will probably be necessary to fine-tune the depth of cut by experimenting with some scraps of wood. Simply follow the jig maker's instructions for making these adjustments.

Once you have fine-tuned the settings, you are ready to dovetail the final pieces. I like to back (or climb) cut the inside edge of the tails to create a clean inside edge for the pin sockets. Proceed to cut the pins and tails as you normally would, then assemble the joint. The longer tailed, slighter-angled dovetail produced with this bit is an improvement over the standard cutter.

'Variable'-spaced Joints

It is also possible to create a variable-spaced dovetail joint with the fixed-finger jig. Again, it takes a bit of planning to ensure that the drawer side ends on a half-pin. In addition, for certain drawer side widths it will only be possible to create asymmetrical dovetails. Another consideration is the number of tails that will show in the assembled joint. I find wider tails with an "odd" number of pins to be aesthetically pleasing.

However, this imposes quite a limitation on the drawer widths that can be used. (If you limit yourself to this convention, it will only be possible to use the widths corresponding to the even-numbered multiplier in the "Drawer Side Width" chart on page 73—assuming you wish to end up with symmetrical tails.)

The following procedure outlines how to produce a variable-spaced dovetail joint that has two half-pins at the top and bottom of a $5\frac{1}{4}$ "-wide drawer side and with a single full-pin in the center.

As before, I used the $1/2$ "-diameter, 8° cutter for this example. Again, set up the jig as you normally would by following the manufacturer's instructions—adjusting the depth of cut to about $25/32$ ". (As before, it may be necessary to fine-tune the depth of cut.) The sequence of accompanying photographs illustrates the procedure.

Don Means is an amateur woodworker and spends much of his free time in his shop (or as his wife refers to it, the garage) in Danville, Calif. He has an engineering background and has been woodworking seriously for about 15 years—mainly constructing furniture and other woodcraft for family and friends. You can view some of Don's completed work at: home.earthlink.net/~mbwoodworks/.

Creating a Variable-spaced Dovetail Joint With a Fixed-finger Jig

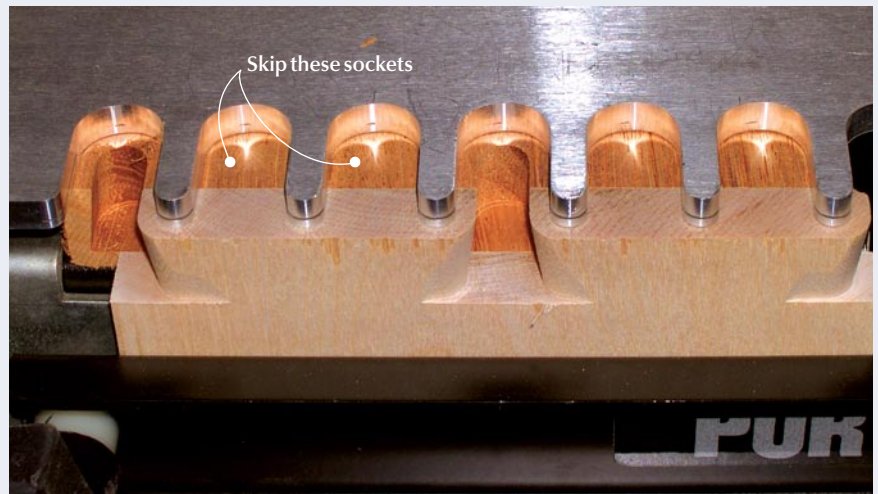

1 Rough cut the tails. With the jig and depth of cut properly set, first take a back cut along the width of the drawer side. Then, as you normally would, start at the inboard end of the jig and rout out the first tail socket. However, do not rout the next slot in the jig template. Instead skip over the next two slots to the fourth slot. Rout out this tail socket, then again skip the next two slots and finish up on the last slot (which should be the outside edge of the drawer side). As you look at the drawer front there should only be two tail sockets routed in the drawer front (or pin board) and two "wide" tails that are roughly defined on the drawer side.

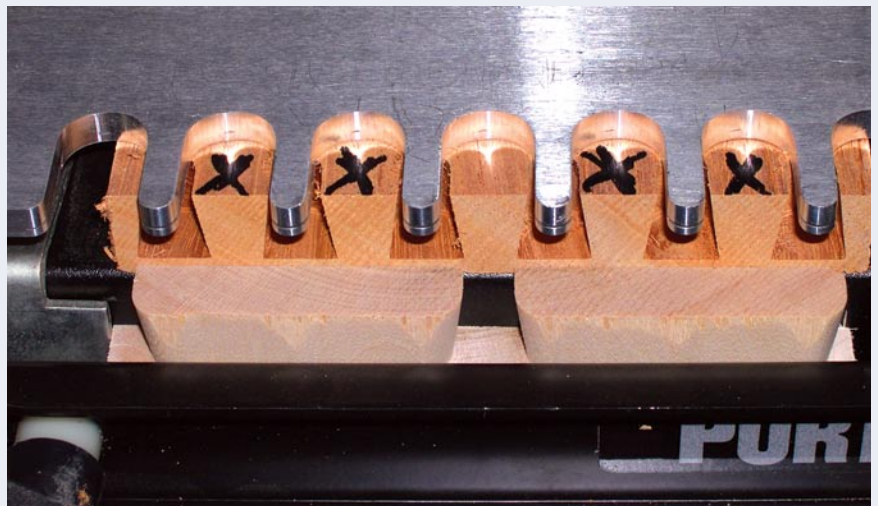

4 Finish the tail sockets. The next several steps in the procedure require you pay close attention to your work. Basically, we are going to manipulate the drawer front in the jig to hog out the unneeded pins in order to create two wide sockets for the wide tails we just milled.

First, unclamp the drawer front and slide it toward the outboard side of the jig (to the right as you are facing the jig) exactly half the finger spacing (do not unclamp the drawer side). At this stage the edges of the drawer front and sides should be aligned and it should become obvious which pins will be removed to create the wide sockets for the tails that were previously cut. Use the drawer side as a reference to square up the drawer front by pushing it up against the tails and re-clamp. At this point, there should be no tail sockets showing (in other words, all you should see are the individual pins). For this particular dovetail layout, unneeded pins will be removed using the second, third, fifth and sixth template "slots" (notice we skipped the fourth slot since this pin is aligned with the pin socket from the tail cutting operation). These steps in the procedure can get confusing if you are not careful. The safest strategy is to use a pen to mark the areas that are to be removed.

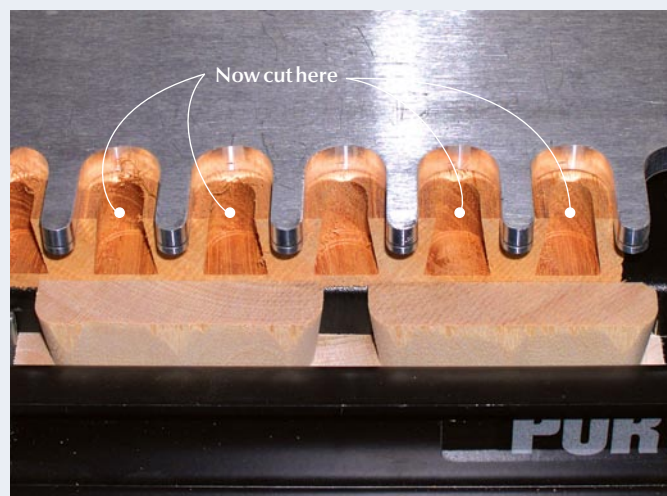
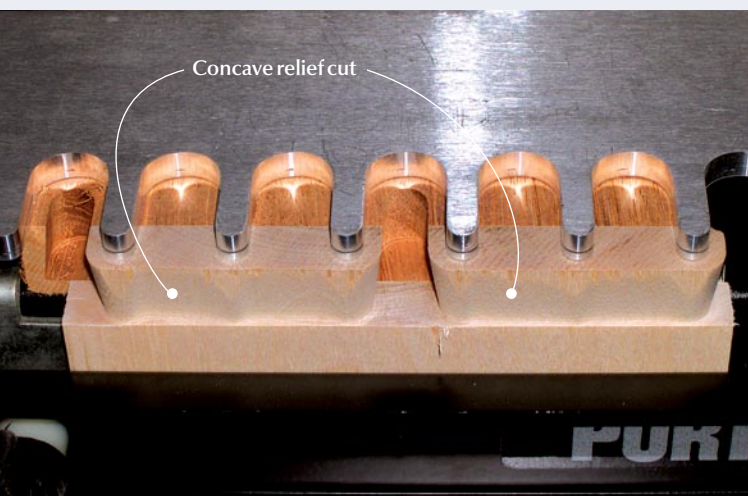

2 Finish the tails. Next it is necessary to “finish” the tails by carefully removing the material on the back (or inside) of each of the tails. This is necessary to ensure the proper fit of the joint. Start at the left-hand side of the jig and carefully move the router from left to right between the template fingers, slightly “dipping” between the template fingers. (It is not necessary that this be a perfectly straight cut since it will be hidden in the assembled joint.)

I usually make this cut slightly concave – just to ensure there will be no interference with the tail socket. Make sure you do not remove too much material as this will begin to affect the strength of the joint (obviously if you cut all the way through the tail you will have ruined the piece).

3 Rough cut the tail sockets. Once the drawer side is complete we turn our attention to the drawer front (or pin board). First, unclamp the drawer side and lower it so the top of the tails are just below the tail sockets on the drawer front and then re-clamp (this is so the router bit will clear the top of the tails when cutting the tail sockets). Now rout out all of the tail sockets as you normally would.



5 Rout between the fingers. Once the drawer front is marked and secure in the jig, rout out the marked areas between the template fingers. After this is complete you should be left with very thin sections of the former pins. Now unclamp the drawer front and slide it toward the inboard end of the jig (to the left) until these thin sections are centered in the template finger slots. As before, use the drawer side as a reference to square up the drawer front.

Clamp the drawer front and hog out the marked sections. At this point it should begin to become obvious how we are manipulating the jig to produce the wide tail sockets. Once this is done, unclamp the drawer front, slide the piece in the opposite direction (to the right) until the remaining thin sections are centered in the template slots (again use the secured drawer side as a reference to square the drawer front in the jig) and repeat the cutting procedure.

6 Ready to assemble. If you performed these last several steps correctly when you remove the drawer front from the jig you will see two wide tail sockets that should perfectly match up to the wide tails previously cut. The joint is now complete and ready to be assembled. **PW**

Arc Drawing Bow

Searching for (and Finding) the Arc of the Competent.

When woodworking throws you a curve, how do you respond? It's easy to become locked into one solution because it's familiar and miss an easy alternative. This is often the case when a curve is part of a design. Laying out and cutting arcs is a common task, but the best way to do it is a matter of scale. Different tactics are needed for larger or smaller radii.

If the radius of a curve is less than 6" or so, a compass is the obvious choice. If the radius is known, it's simply a matter of setting the compass point to the right dimension and swinging the arc. But many times, particularly if you're creating a new design, you don't know (and likely don't care) what the radius is. You want the arc to stop and start at certain points along an edge, and you want the high point to be a certain distance from the edge.

If this is this case, here is a simple way to find the radius you want, using your layout tools to find it. It is easier to do this on a piece of graph paper or a scrap of plywood rather than on an actual workpiece, because the point of the compass will end up off the edge of the piece.

Start with a horizontal line representing the edge. In most cases, such as a table apron, the curve should start and stop a 1/2" or so from the end of the board. This gives you more control of the intersection, and if you round off the point where the short straight line meets the arc, it will look like a continuous curve.

At the center of the horizontal line, make a vertical line with a mark at the rise of the arc. Scratch your head and feel some regret about sleeping through high-school geometry. Snap out of that, then pick up your compass and a straightedge.

Set the compass to the distance between an end of the arc and the high point, and swing an arc above and below from each end, ending up with two curved Xs. It might make you feel



The important part. When drawing an arc, where it stops and starts, and the high point in between are more important than knowing the exact radius. Connect those points and you're ready to go.

better to do the same thing from the other end of the arc too, but you don't really need to.

Place the straightedge across the intersections of the Xs and draw a line below your arc-to-be. The point where this line meets

the center vertical line is the center of your arc. If you drew from the other side as well, two angled lines and the center line should all intersect.

Put the point of the compass on the inter-

CONTINUED ON PAGE 78

OPENING PHOTO BY AL PARRISH

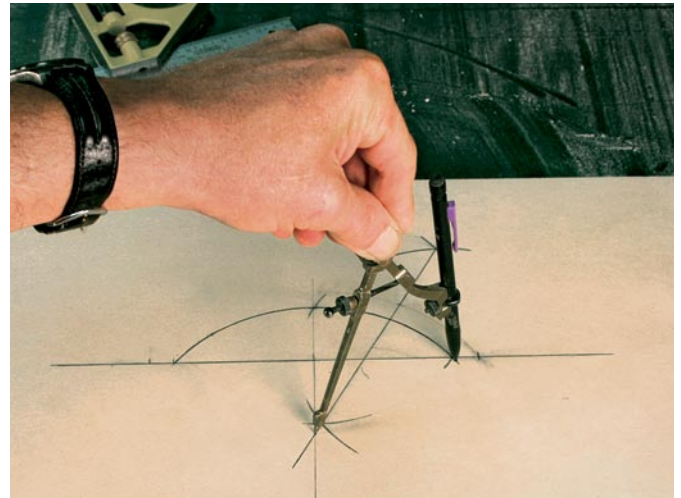
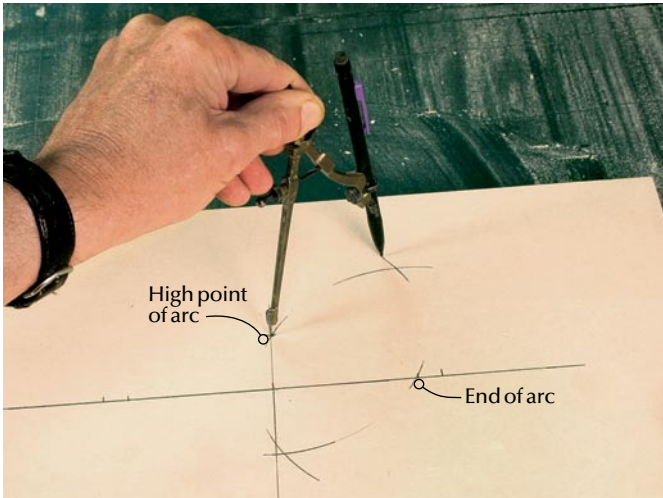

No numbers needed. After laying out the ends and high point of an arc, set the compass to the distance between one end and the high point. Swing partial arcs above and below the edge line from each of these points.

Find your center. Draw a line between the intersections of the partial arcs. Where this line meets the vertical centerline is the center of the arc. Set the compass to the distance between this point and either the end or high point and draw the arc.

section and adjust the compass so that the pencil lead is at either of the arc's ends, or the high point. Draw the radius and pat yourself on the back. The important part of solving this problem isn't numbers, it's distances. After you establish the ends of the arc and the high point, you don't need numbers any more.

This is all well and good until you get beyond the limits of your compass. The solution isn't to keep buying larger and larger compasses. The answer to the problem is to find another way to draw a fair curve across the three points you want to hit.

The drawing bow is simply a thin, straight-grained piece of wood. How thin is a matter of how tight a bend you need to make. I've found that $1/8"$ to $3/16"$ works most of the time.

If the thickness isn't consistent, or if the grain runs wild, you won't get a consistent curve. Keeping these considerations in mind, look for a likely candidate on the floor next to your table saw.

To draw a curve, you need to bend the bow and hold it in position against the two ends and the high point of your arc, then trace along the edge of the bow with a pencil. This is hard to do if you only have two hands. One method is to drive 6d finishing nails to bend the bow against. If you place some inside, and some outside the bow, you can hold it in place.

Or you can tie a string between the two ends to adjust the bow and hold it in the arc you want. I whittle a couple notches on both ends to keep the string from slipping. One

end is tied permanently. At the other end, if you make an underhand loop, you can pull the string tight without it slipping back as you adjust the curve.

When the bow is hitting the correct points, make another underhand loop and pull the end tight. This keeps the string and adjustment in place. If you're a sailor, a Boy Scout or a cowpoke, you'll recognize this as a clove hitch. If this is new to you, you've learned one of the most useful knots as well as an easy way to draw a curve of any radius. **PW**

Bob is the author of "The Complete Kitchen Cabinet-maker" (Cambium) available from his web site, craftsmanplans.com. Contact Bob at 513-531-2690, ext. 1327 or robert.lang@fwpubs.com.

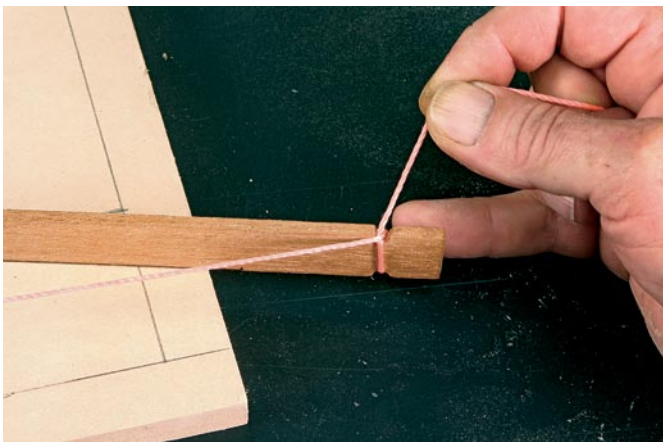

No-slip knot. Loop the string around the bow and pass the end underneath. You can adjust the bow by pulling the end of the string, and it won't slip.



Security loop. A second loop secures the knot and prevents it from becoming loose. This knot will also keep your horse or boat from getting away, no matter how hard they try.

Finger Tops

Fun to turn and pretty to look at, these little spinners will enhance your skills.

Tops are the atoms of woodturning; so simple, yet you can do so many things with them. Simple or fancy, they are fun to make, and wonderful gifts for anyone, on special occasions or no occasion at all.

Method One

There are at least two basic ways to make a top. You can mount a single piece of wood, about 2" square by 2½" long, and turn the entire top, disc and stem from this one piece.

Small limbs, cut to length, also work well, as long as the pith is not exactly in the center. The advantage of this kind of top is that there is virtually no prep, and the turning is simplified in that all cuts are made from large to small diameter, as with any other spindle.

Disadvantages would include wasting a good deal of wood, as most of the piece would be turned away. And because this kind of top is generally turned between centers, it's not possible to part off both points cleanly, so you may have some shaping or sanding to do (to make them sharp and concentric) after the piece is off the lathe.

Method Two

The second major category of tops is made by gluing a dowel through the center of a flat disc of wood, then mounting the dowel into a chuck for turning. Advantages include getting more tops out of a given amount of wood, the pleasing contrast between the different woods (of disc and dowel), and ease of mounting and parting off.

Disadvantages would be having to turn the disc from the center out (if the grain of the disc runs perpendicular to the axis of rotation – and the dowel – as described here) but the stem from outside in. Also, there is some prep involved. For me, this kind of top is better because I get many more tops out of a given



Spinning tops. There are a vast number of decorative and material possibilities when turning finger tops. Exotic woods, bone, antler, plastics and even countertop composites can be turned into these fun little gifts. To add an extra decorative touch, consider gluing up contrasting woods for blanks, adding beads around the edges, or burning a design the wood.

amount of material, and it's how I've always made them.

To make these tops, you need scraps of wood about ½" thick x 2" wide x 2" long. Thicker scraps can be sliced on the band saw to appropriate thicknesses after drilling the holes. The grain runs lengthwise in the scraps; i.e., they are just very small boards, not cross-wise slices of thicker boards, the grain will be perpendicular to the stem of the top.

After drilling and trimming the pieces, glue a piece of dowel ¾" diameter x 2½" long through the hole in the disc. Then mount this on the lathe and turn as described in the photos on the following pages.

Plethora of Possibilities

Once you have mastered the basic procedures, many variations are possible. I've made tops larger and smaller than these, double- or triple-decker tops, tops with beads, painted or woodburned tops, and tops made of all kinds of odd materials including bone, antler, horn, plastic, countertop composites, glued-up stock with contrasting woods and more. See how many you can come up with; they will provide you with hours of fun both at the lathe and afterward.

Judy, author of two turning books and many articles, has been turning since 1985. She teaches and demonstrates her skills throughout the United States and Canada.



1 *Scraps of nice wood for tops.* Whenever I'm cutting up wood, I trim scraps to suitable sizes and put them into a box I keep next to the band saw.



2 *A few possibilities for making tops from unusual materials* (clockwise from the bottom): horn, walnuts (these didn't work out so well, but might do so with some judicious use of epoxy), banksia pods, plastic and solid-surface countertop materials.



3 *Top blanks ready to turn* (clockwise from bottom right): "regular" tops (the ones I make by the thousands every year), miniatures, assorted fancy tops, including double-deckers, and top blanks in various alternative materials.

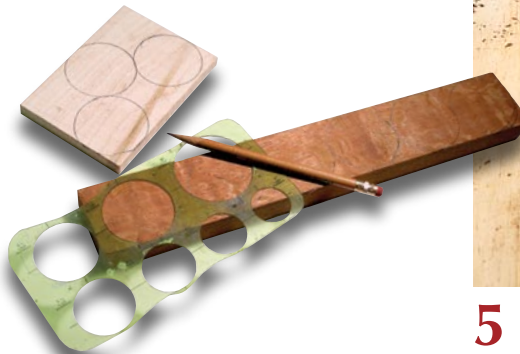

4 *Mark circles on your scrap wood.* I usually start with 2" circles, but with very fancy wood I'll go down to 1 1/2" or so, or set the stock aside to make minis.

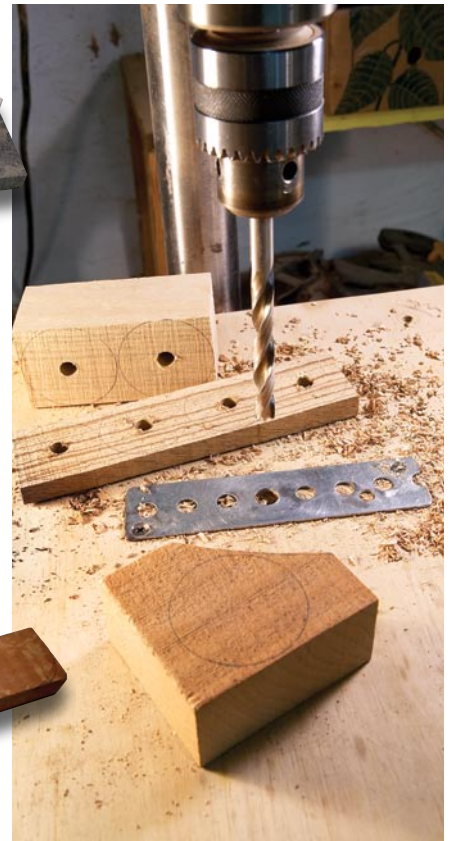

5 *Drill the blanks to receive the 3/8" dowels.* I use a 3/8" brad-point bit (it's useful to have one that is 1/64" undersized as well, since it's not always possible to find accurately sized dowels). The steel plate screwed to the drill table has a 1/2"-diameter hole placed concentric with the drill bit; this prevents most tear-out (especially on thin pieces).



6 *I just eyeball the center of each piece.* You will be turning the piece round, so it doesn't have to be exact. You may want to hold the scraps in large locking pliers or with a vise or handscrew clamp; very hard, dense woods can be pulled from your grasp when being drilled.



7 *Pieces that are thicker than one top* are sliced prior to being cut out. Leave the slices connected by a thin bit of waste at one end; this makes it easy to cut out several at a time. Watch your fingers. Never push toward the blade with your fingers aligned with the blade; keep them in a position (and exert force in a direction) that will move them past the blade should it unexpectedly exit the wood.



8 When you have sliced the thicker pieces, trim off the corners of all the pieces. You don't need to cut actual circles; knocking off the corners is enough. The rest will happen very quickly on the lathe. Pay attention to safety; you need to stay alert for this kind of small work on the band saw.



9 Since I am usually preparing hundreds or thousands of these blanks at once, I've developed a reasonably efficient way of gluing them up. First, lay the prepped pieces of wood out on a bench and tap the dowels into them. Put a piece of tape along the edge of the bench and lay a thick bead of glue along the edge. Roll each top stem in the glue just above the disc.



10 Drive the stem into the disc. For this, I have a very simple jig; a piece of 1 1/2"-thick hardwood with a 5/8" hole drilled to the depth you want for the bottom of the stem to protrude (about 3/4").



11 The tailstock is fitted with a live center that has had the point removed. This allows the end of the dowel (stem) of the top blank to simply bottom out in the recess of the live center. This quickly centers the dowel, and prevents splitting it, as pushing a point into it would do.



12 When you turn thousands of tops per year as I do, it becomes very important to shave off time wherever possible. I keep a reversible driver on a bungee cord next to the lathe (so I don't have to pick up the weight of the driver 40 or 50 times an hour), with a chuck key mounted on it that fits the Jacobs-style chuck on the lathe. To mount a blank, I grab the driver and pull it over to the lathe ...



13 ... with the driver in reverse, open the jaws of the lathe chuck all the way and place the short end of the blank into the opened jaws ...



14 ... then move the blank forward into the recess in the live center ...



15 ... and with the driver in forward, fit the key into the chuck and tighten the jaws around the stem. With practice you can get the workpiece mounted in just a few seconds. Don't tighten too much or you'll crush the dowel and it will blow apart in turning.

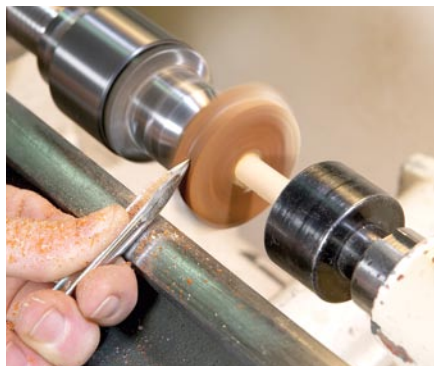

16 Begin turning by rounding off the outer rim of the top. Use a long fingernail-grind spindle gouge, and cut with the long side (either direction is fine here). Go slowly and take small cuts; it's easy to break the stem by applying too much force. Position the tool so the bevel rides behind the cut as soon as the edge is far enough into the wood.



17 Using the same gouge, bite into the stem just above the disc, then draw the gouge outward in a scraping cut (bevel is not rubbing). Keep the bevel well away from the wood, or the edge will dig in. Cutting from the center outward will help get a clean cut on the disc. Tapering the cut (to be thinner at the outer edge) will make the cut easier, and makes the finished top look more elegant.



18 Another cut you may want to learn is a shearing cut, done with the same tool (but considerably more difficult to master). At the same instant you move from the stem to the disc, you roll the tool clockwise so that the bevel is riding on the disc, and pull the tool all the way out to the edge. Be warned: It takes some practice to do this cut without blowing up the blank. If you come off the bevel the tiniest bit, the edge will dig in violently and the entire blank will probably disassemble itself. You must wear a face shield; it is not safe to turn even small items like this without one. The pieces will come right at your face when the blank breaks. (And they will, from time to time; I've made about 60,000 of these and I still break some.)



19 After cutting the other side of the disc (just reverse the position of the gouge, and again cut from the center outward), begin tapering the upper stem of the top.



20 Cut a smooth taper from the disc to the tip, and part off from the waste (which will probably fall away at this time).



21 Move back around to the bottom of the turning, reversing the position of the gouge, and taper the stem to a point. I usually just catch the top in my left hand (I'm turning backward here, with my left hand on the gouge, so that you can see what I'm doing) while parting with the right.



22 Catching the top like this takes some practice; if you aren't comfortable doing it this way, keep both hands on the gouge and go find the top later on. It's out there somewhere in all the shavings.

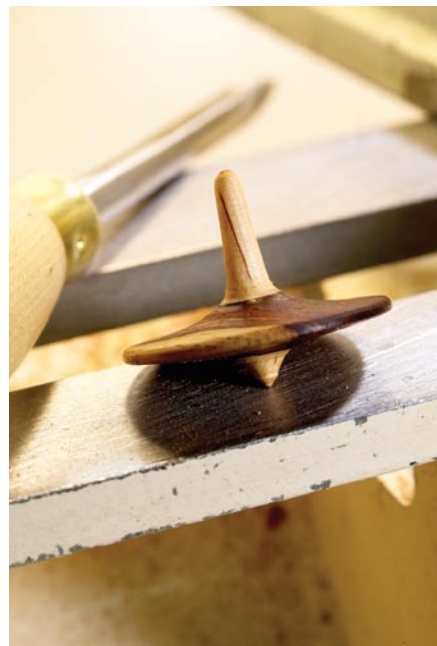

23 The finished top. After a few hundred more, you'll get the hang of it. **PW**

BY BOB FLEXNER

A Primer on Solvents

Categorize by type to cut through confusion.

Unless you've been doing wood finishing for quite a while, I imagine the shelves of solvents in home centers and paint stores look pretty much like Greek to you. Which solvent goes with what? How does one make sense of all the possibilities?

Here's the easy way to understand solvents for wood finishes.

First, divide the solvents between the petroleum distillates, including turpentine, and all the rest. Because most of the solvents on the shelves are petroleum distillates, this reduces the remaining products to a number that's easy to handle.

Then make sense of the petroleum distillates and turpentine, all of which do essentially the same thing at different evaporation rates, and when this is done, deal with what is left.

Petroleum Distillates

Petroleum distillates are all distillations of petroleum. They include mineral spirits (paint thinner), naphtha, toluene, xylene and some

"turpentine substitutes" such as Turpatine and T.R.P.S. The primary use for these solvents in wood finishing is thinning waxes, oils and varnishes, including polyurethane varnish, and cleaning brushes. The solvents are also used to clean oil, grease and wax.

Turpentine is a distillation of pine-tree sap. Before the mid-20th century, turpentine was widely used as a thinner and clean-up solvent for oil paint and varnish, and also as a grease and wax cleaner.

With the growth of the automobile industry and its need for petroleum products, a large number of petroleum solvents were introduced and these have almost entirely replaced turpentine because they are less expensive and have a less unpleasant odor. The only sector in which turpentine is still used in any significant quantity is fine arts.

To distill petroleum, it is heated higher and higher and the gases released at different temperatures are condensed into the various liquid solvents.

The first gas to come off is methane, which

doesn't condense at room temperature, only at much colder temperatures. Then there's ethane, propane, butane, etc. Heptane and octane are used to make gasoline, a liquid that evaporates very rapidly. Gasoline is sometimes used as a cleaner, but it is very dangerous because it is explosive. About 20 years ago the retired local sheriff in my town, an amateur woodworker, died of burns he received in an explosion while using gasoline for cleaning.

The solvents we use in wood finishing evaporate much more slowly than gasoline and are relatively safe to use, even with poor ventilation. But it's still unwise to use them in a room with a flame such as a pilot light.

Mineral Spirits and Naphtha

The two most widely used finishing solvents are mineral spirits and naphtha. For our purposes, the principal differences between the two are evaporation rate and oiliness. Naphtha evaporates more quickly than mineral spirits and is "drier," that is, less oily. Naphtha is therefore better for cleaning all types of oily,



Categorize. The easy way to make sense of solvents is to divide them into petroleum distillates (left) and all the others (right). Once you have understood the petroleum distillates, all of which do essentially the same thing at different evaporation rates, it's easy to handle the rest.



Thinning varnish. Any petroleum distillate or turpentine can be used to thin wax, oil or varnish, but mineral spirits (paint thinner) is best. It gives the finish time to level and is less expensive and has less unpleasant odor than turpentine.

greasy or waxy surfaces. Mineral spirits is better for thinning oils, varnishes (including polyurethane varnish) and oil-based paints because it leaves more time for the coating to level after brushing.

Naphtha is a stronger solvent than mineral spirits, but this is rarely significant in wood finishing. Mineral spirits is strong enough for any normal operation.

To better place turpentine among the petroleum distillates, think of it as having the solvent strength of naphtha but the evaporation rate and oiliness of mineral spirits. I don't know of any situation in wood finishing where this is important.

The nickname for mineral spirits is "paint thinner." Back in the early days of mineral spirits, before World War II, all paints were oil-based. So there was only one thinner for paint. The nickname made sense.

Today, with water-based paints and finishes in wide use, the name could be confusing to beginners. Paint thinner is used only with oil-based paints and finishes.

It's important to emphasize that mineral spirits and paint thinner are the same thing. Amazingly, there are manufacturers who try to trick you into paying more by labeling their containers "pure" mineral spirits and charging more.

The common naphtha available in paint stores is VM&P Naphtha. VM&P stands for "varnish makers and painters." Stronger and faster evaporating naphthas exist, but these are rarely sold to the general public.

Toluene and Xylene

Toluene, nicknamed "toluol," and xylene, nicknamed "xylol," are the strong, smelly, fast



Cleaning oily surfaces. Naphtha is usually better than mineral spirits for cleaning oily or waxy surfaces (including crayon marks) because it evaporates much faster. Naphtha also has more solvent strength than mineral spirits, which is sometimes helpful on old waxed surfaces like this one.

evaporating and "dry" parts of mineral spirits and naphtha. These solvents are removed from mineral spirits and naphtha at refineries and sold separately as cleaners, and also as solvents for some high-performance spray finishes such as conversion varnish. Toluene and xylene are very effective as cleaners, but I find naphtha adequate for almost all situations.

Toluene evaporates a little more quickly than xylene, but this is significant only when using the solvent as a thinner.

The problem with these two solvents is that they are relatively toxic. They will affect your nervous system causing irritability and drunkenness, and in large doses could cause serious health problems. You should never use them in any sizeable quantity in a room without good exhaust.

One very interesting use for toluene and xylene is to soften latex paint. Using a dampened cloth (and solvent-resistant gloves) you can easily remove latex paint that has spattered off a paint roller, or even a full coat of



Cleaning latex. Toluene and xylene are very useful for removing latex paint spatter from all surfaces except water-based finishes. The commercial products "Oops!" and "Goof Off" are based on xylene and sold for this purpose.

latex paint, from any finish except water-based finish, without causing any damage to the underlying finish. In fact, the products sold specifically to do this, "Oops!" and "Goof-Off," are principally xylene.

Because white and yellow glues are the same chemistry as latex paint, you can also use toluene or xylene to soften and scrub these glues from wood when you have glue seepage or fingerprints that you didn't fully remove during sanding. You will need to use a toothbrush or soft brass wire brush to get the glue out of the pores.

Odorless Mineral Spirits

The mineral spirits left after the toluene and xylene are removed is sold as "odorless" mineral spirits. When understood this way, it's obvious that odorless mineral spirits is a weaker solvent than regular mineral spirits. But I've never found this to be a problem. It still appears to be strong enough to thin all common oils, varnishes and oil paints.

The disadvantage of odorless mineral spirits, of course, is that it is considerably more expensive because of the extra steps necessary to produce it. You may find the extra expense worth it, however, just to avoid the unpleasant odor of regular mineral spirits.

Turpentine Substitutes

The so-called turpentine substitutes are an interesting breed. My first question when I talk to the companies that produce them is, "Isn't that the role of mineral spirits?" (One company spokesman, identified as the "chemist," explained that these products were necessary because of all the protests against cutting down trees to make turpentine! Of course, trees aren't cut down; the sap is drained.)



Thinning shellac. Denatured alcohol is the best solvent for thinning shellac. It is much less toxic than methanol.

Actually, these solvents seem to have similar characteristics to turpentine in that they have the solvent strength of naphtha but an evaporation rate closer to mineral spirits. So they are useful to fine artists but provide no special benefit to wood finishers.

These are all of the petroleum distillates used in wood finishing. Now for the other solvents.

Alcohol

Alcohol is the solvent for shellac. The solvent dissolves solid shellac flakes and thins the liquid shellac after dissolving. There are two alcohol types available at paint stores: methanol and denatured.

Methanol evaporates a little faster than denatured, but it is toxic and could blind or even kill you if you breathe too high a vapor concentration for too long. You shouldn't use it unless you have good ventilation in your shop.

Denatured alcohol is ethyl alcohol (the alcohol in beer, wine and liquor) that has been made poisonous so we don't have to pay liquor taxes to buy it. This is the alcohol you should use with shellac.

In situations where shellac is not the finish, alcohol has the further use as a felt-pen-ink remover. Dampen a cloth and wipe over the mark and you will remove it in most cases. You won't damage any finish except shellac as long as you don't soak the surface.

Lacquer Thinner

Lacquer thinner is the solvent and thinner for all the types of lacquer, including nitrocellulose, CAB-acrylic and catalyzed. It's the most interesting of the solvents because it's composed of half-a-dozen or so different individual solvents. Manufacturers vary these to control solvent strength and evaporation rate.

Solvents from five different families are used in lacquer thinners, including toluene, xylene and "high-flash" (meaning fast evaporating) naphtha from the petroleum-distillate family. The other four families are ketones, esters, glycol ethers and alcohols.

All the individual solvents from the ketone, ester and glycol-ether families dissolve lacquer on their own, but they evaporate at different rates. So manufacturers choose among them to make a thinner that evaporates in steps at the speeds they want. Alcohol doesn't dissolve lacquer on its own, but it does when in combination with these other solvents. So one or more of the alcohols is usually added



Felt-tip removal. Denatured alcohol is especially useful for removing felt-tip-pen marks. The solvent won't damage any finish except shellac as long as you don't soak the surface.

to the mix to reduce cost.

The nature of lacquer is that it can be fully dissolved and still be too thick to spray efficiently. So to further thin the lacquer without adding expensive dissolving solvents, manufacturers add up to 50 percent toluene, xylene or high-flash naphtha to, in effect, "thin" the lacquer thinner.

By varying the solvents used, manufacturers can control the strength of lacquer thinner (automotive lacquers need a higher percentage of dissolving solvent) and the speed of evaporation. For example, lacquer retarders are made to evaporate slower so the lacquer stays "open" on the surface of the wood longer in order to eliminate blushing (turning white) in humid weather and dry spray (a sandy surface) in hot weather.

The purpose of using multiple individual solvents evaporating at intervals is to control the thickening of the lacquer on a vertical surface to reduce runs. The lacquer thickens quickly after being sprayed but enough of the slower evaporating solvents remain so the finish has time to flatten out. Lacquer thinner is unique among solvents for having this characteristic.

A cheaper "clean-up" lacquer thinner is often available. It's made with a higher percentage of "thinning" petroleum-distillate solvents and doesn't dissolve lacquer well. You will have problems if you use this thinner for thinning lacquer.

Acetone and MEK

Only one of the families of active solvents in lacquer thinner (ketones, esters and glycol ethers) is commonly available in paint stores. This is the ketone family. The two fastest evaporating ketones, acetone and methyl ethyl ketone (MEK), are usually available.

Both make excellent cleaners, but keep



Thinning lacquer. Lacquer thinner is a blend of half-a-dozen or so solvents specially formulated for thinning lacquer. The blend allows for differing evaporation rates and for evaporation in steps to reduce runs on vertical surfaces.

in mind that they will damage and remove all but the most solvent-resistant paints and finishes.

Brush Cleaners and Deglossers

Brands of brush cleaner and deglosser (liquid sandpaper) vary greatly in their composition. Some are even water-based, but these work more slowly and are less effective than solvent-based.

You can usually substitute a brush cleaner for the mineral spirits or lacquer thinner you may otherwise use to clean your varnish, lacquer or water-based finish brushes. (It's easiest to clean shellac with household ammonia and water.) Brush cleaners are usually more expensive, however.

What is left unsaid about deglossers is that it matters greatly what paint or finish you're trying to clean and dull. Cleaning grease or wax is no problem, but high-performance paints and finishes such as powder and UV-cured coatings, catalyzed lacquer, conversion varnish and even oil-based polyurethane are very solvent resistant. So it's rarely possible to dull them short of abrading with real sandpaper or steel wool.

Conclusion

Manufacturers are very creative in their labeling, so you could easily come across solvents with different names than the ones I'm using. But if you read the intended uses listed on the containers, you should be able to place them in one of the above categories. **PW**

Bob is the author of "Understanding Wood Finishing" and a contributing editor to Popular Woodworking.

BY JEFF SKIVER

The Boys in the Guild

No doubt, you'll fit right in.

A woodworking club offers countless rewards to the aspiring craftsman. It provides a platform for displaying your work. It offers the chance to learn new techniques. It affords you the opportunity to find tutelage and mentoring, like Croesus consulting the Oracle, Luke studying with Yoda, or Chachi hanging with The Fonz. Above all, a good woodworking guild provides the life experience of learning to deal with a bunch of wackos.

If you're thinking of joining a local woodworking group, be prepared to encounter, embrace and make lifelong friends with the following folks who are present in every woodworking society in the world.

Although the average woodworker is likely the power-tool expert of his family, neighborhood and workplace, "Power Tool Jimmy" goes at least 17 steps beyond the norm (no pun intended, Mr. Abram). While most woodworkers can spot the difference between power tool brands from 300 feet away or know which routers have a D-handle option available, Power Tool Jimmy uses up valuable club time to discuss the subtle differences of in-rush current between the U.S. version of a 3½ hp router and the European version that operates at 230V/50Hz.

Try not to flinch when you first shake the appendage that "Stumpy Wheeler" extends in greeting. Yes, advances in surgery have made it possible for his big toe to now function as a replacement thumb. Also, do not be shocked when about halfway through the meeting he says, with the accompanying large expressive hand/toe waving gesture of a TV meteorologist, "I've never personally seen the need for those guards they put on all the equipment. As soon as I wipe off the Cosmoline, that guard is the next thing to go."

"Video Bob" owns every woodworking video ever made, but he's never actually put



steel to wood. Bob can tell how you how to do anything, but he hasn't ever done it himself. He knows the subtle differences between Tage Frid's and Frank Klausz's dovetail videos. If you have a band saw question, he will quote Mark Duginske's video – chapter and verse. Bob has watched it all again and again but has never encountered a speck of sawdust. With more than 500 hours spent in front of the television, he has never had a splinter.

No one has ever seen his work, but "One Up Tom" has described an amazing portfolio of work. Every month as guild members display their new heirlooms, Tom describes pieces he has created that are always far superior.

"These machine-cut dovetails are nice, if you like that kind of thing; the one I made for my daughter has hand-cut dovetails." Or: "The plainness of the maple you used on this blanket chest looks good, Charlie. The bird's-eye maple I used on mine last year is so eye catching that no one ever notices the perfect joinery I used ... they only see the beauty of the figured wood." Or: "My 5 hp saw cuts through 8/4 cocobolo all day long, Phil. Does that 3 hp saw of yours bog down a lot?" Tom's

customary summary to any discussion is, "Well, yours is nice, too."

Each month "Pallet Wood Larry" provides another tale of his exploits of frugality. Two months ago he described a highboy made entirely of OSB cutoffs he got from the subdivision going in across town. Last month, he told the details of a tall clock made from pallets gleaned from the shipping dock behind TJ Maxx. Larry has spent his life creating unique furniture, and the only piece of lumber he ever actually paid for came from the Good Humor Man and had ice cream attached.

Search out and join a woodworking club. You are bound to fit right in. The only place you will find personalities more eccentric is at your family reunion. I could describe additional wackos, but my own guild meeting is tonight and people will be disappointed if "Cynical, Know-It-All Magazine Writer Guy" is late. **PW**

Jeff Skiver, who designs car parts for a living, stumbled into woodworking in 2004 when he built a sauna in his basement and found that he really liked it — woodworking, that is ... not the sauna. But, he loves the sauna, too.